

Experts in Bearing Solutions



Applications Catalog

Catálogo de Aplicações / Catálogo de Aplicaciones



Index

Índice

Índice

- 01 Catalog Index 2012 /
Índice de Catálogos 2012 /
Índice de Catálogos 2012 II
- 02 Brand Index /
Índice de Marcas /
Índice de Marcas III
- 03 Numerical Index /
Índice Numérico /
Índice Numérico XIII
- 04 Introduction /
Introdução /
Introducción XXVI
- 05 Agricultural /
Agriculturas /
Agrícolas 02
- 06 Bus /
Ônibus /
Autobús 40
- 07 Cars /
Veículos Leves /
Automoción 112
- 08 Trailer /
Trailer /
Trailer 184
- 09 Truck /
Caminhão /
Camión 214
- 10 Lists & Adicional Information /
Listas e Informação Adicional /
Listados e Información Adicional 384
- 10.1 Fersa Numerical List /
Lista Numérica Fersa /
Lista Numerica Fersa 386
- 10.2 Fersa Dimensional List /
Lista Dimensional Fersa
Lista Dimensional Fersa 393
- 10.3 Fersa Kits List /
Lista de Kits Fersa /
Lista de Kits Fersa 400
- 10.4 Type of Bearing Numerical List /
Lista Numérica por Tipo de Rolamento /
Lista Numérica por Tipo de Rodamiento 401
- 10.5 Type of Bearing Dimensional List /
Lista Dimensional por Tipo de Rolamento /
Lista Dimensional por Tipo de Rodamiento 407
- 10.6 References Fersa
with Multiple Applications /
Referências Fersa
com Múltiplas Aplicações /
Referencias Fersa con Múltiples Aplicaciones..... 413
- 10.7 Application by Fersa Reference /
Aplicação por Referência Fersa /
Aplicación por Referencia Fersa 414
- 10.8 OEM References List /
Lista de Referências OEM /
Listado de Referencias OEM 581
- 10.9 Cross References /
Cruzamento de Referências /
Cruce de Referencias 602
- Fersa - FAG 602
- FAG - Fersa 604
- Fersa – SKF 607
- SKF - Fersa 609
- 10.10 Nomenclatures /
Nomenclaturas /
Nomenclaturas 612
- 10.11 Drawings /
Desenhos /
Planos 613

Symbols & Abbreviations

Símbolos & Abreviações

Símbolos & Abreviaturas

Symbols / Símbolos / Símbolos

	Agricultural	Agrícolas	<i>Agrícolas</i>
	Bus	Ônibus	<i>Autobús</i>
	Cars	Veículos Leves	<i>Automoción</i>
	Trailer	Trailer	<i>Trailer</i>
	Truck	Caminhão	<i>Camion</i>

Abbreviations / Abreviações / Abreviaturas

BB	Deep groove ball bearing	Rolamento radial de esferas	<i>Rodamiento de Bolas</i>
BB 4PAC	Angular contact ball bearing	Rolamento de contato angular	<i>Rodamiento de bolas de cuatro puntos de contacto angular</i>
BB2R	Double row ball bearing	Rolamento de dupla carreira de esferas	<i>Rodamiento de bolas de doble hilera</i>
BBDRAC	Double row angular contact ball bearing	Rolamento de contato angular de dupla carreira de esferas	<i>Rodamiento de doble hilera de bolas de contacto angular</i>
BBS	Special ball bearing	Rolamento de esferas especial	<i>Rodamiento de bolas especial</i>
CRB	Cylindrical roller bearing	Rolamento cilíndrico	<i>Rodamiento de rodillos cilíndricos</i>
CRBS	Cilindrical Roller bearing special	Rolamento de rolos cilíndricos especial	<i>Rodamiento de rodillos cilíndricos especial</i>
CWT	Compact Wheel Truck	Unidades de cubo de roda CWT	<i>Unidad de buje compacta</i>
HWT	Hub Wheel Truck	Unidades de cubo de roda HWT	<i>Unidad de buje de rueda</i>
KIT	Passenger car Kit	Kit de roda para veiculos leves	<i>Kit de rueda de turismo</i>
KWT	Kit Wheel Truck	Unidade de cubo de roda KWT	<i>Kit de rueda de camión</i>
TRB	Tapered roller bearing	Rolamento de roletes cônicos	<i>Rodamiento de rodillos cónicos de una hilera</i>
TRBDR	Double row tapered roller bearing	Rolamento Bi-Cônico (Rolamento de dupla carreira de roletes cônicos)	<i>Rodamiento de rodillos cónicos de doble hilera</i>
TRBS	Special tapered roller bearing	Rolamento de roletes cônicos especial	<i>Rodamiento de rodillos cónicos especial</i>
TRBT	Thrust tapered roller bearing	Rolamento axial de roletes cônicos	<i>Rodamiento de rodillos cónicos axial</i>
U Series	U Type bearing"	"Rolamento tipo "U"	<i>Rodamiento de tipo U</i>
CA	Central America	América Central	<i>Centro América</i>
MX	Mexico	Mexico	<i>México</i>
NA	North America	América do Norte	<i>Norte América</i>
SA	South América	América do Sul	<i>Sur América</i>
...91	Up to year	Até o ano	<i>Hasta el año</i>
91...	From year	A partir do ano	<i>Desde el año</i>
91...99	From year... up to year	De ... até...	<i>Desde ... hasta ...</i>
...32194	up to chassis	Até número de chassis	<i>Hasta el chasis</i>
...32195...	from chassis	A partir de chassis número	<i>Desde el chasis</i>

Catalog Instructions

Instruções de Catálogo

Instrucciones del Catálogo

Legend / Legenda / Leyenda

	Vehicle Type Tipo de Vehículo Tipo de Vehículo	Wheel Bearings Position Posição do Rolamento de Roda Posición del Rodamiento de Rueda	Information Informação Información	Fersa Reference Referência Fersa Referencia Fersa	OEM Reference Referência OEM Referencia OEM	Bearing Type Tipo de rolamento Tipo de Rodamiento	
		OUT	IN		Fersa®	N° OEM	
Brand Marca Marca	ALFA ROMEO	A					
Model Modelo Modelo	Alfa 2300	B					
Application Aplicação Aplicación	Gearbox / Câmbio / Caja de Cambios	C					
Application Part Parte de Aplicação Parte de Aplicación	Intermediate shaft / Eixo intermediário / Eje Intermediario	D	B * SL * TI 4	N E 205	105121326000	CRB	
	Intermediate shaft (rear) / Eixo intermediário (traseiro) / Eje intermedio (trasero)		B * SL * TI 4	NJ 206	105121326000	CRB	
	Secondary shaft (rear) / Eixo secundário (traseiro) / Eje secundario (trasero)		B * SL * TI 4	NJ 205 / C3	105121391000	CRB	

Search According to Application / Método de Busca por Aplicação / Método de Búsqueda por Aplicación

Find the bearing that corresponds to the model and application:

- A** Know the vehicle brand name.
- B** Find the model.
- C** Look inside the model for the application specifics.
- D** Determine the part of the application it belongs to.
- E** Select the appropriate bearing.

Conhecendo o modelo e a aplicação para buscar o rolamento correspondente:

- A** Localizar a marca do veículo.
- B** Depois localizar o modelo.
- C** Dentro de modelo buscar a aplicação do veículo.
- D** Localizar a parte da aplicação de que forma parte.
- E** Finalmente seleccionar o rolamento necessário.

Conociendo el modelo y la aplicación para buscar el rodamiento correspondiente:

- A** Localizar la marca del vehículo.
- B** Después localizar el modelo.
- C** Dentro del modelo buscar la aplicación del vehículo.
- D** Localizar la parte de la aplicación de la que forma parte.
- E** Finalmente seleccionar el rodamiento necesario.

Search according to OEM Number/ Método de Busca por N° OEM / Método de Búsqueda por N° OEM

If you know the OEM number:

- 1 In the OEM reference List table (page ---) look for the corresponding Fersa reference.
- 2 Find the Fersa reference in the table under the heading Applications by part number (page ---). Please be sure to verify the application referenced.

No caso de possuir o número de referencia OEM:

- 1 Busque o número de referencia OEM na tabela Lista de referência OEM (pág. ---), anote a referência Fersa correspondente.
- 2 Busque a referência Fersa na tabela Aplicação por número da referência (pág. ---), e verifique a aplicação.

Si usted tiene el número de referencia OEM:

- 1 Busque el número de referencia OEM en la tabla Listado de referencia OEM (pag. ---), apunte la referencia Fersa correspondiente.
- 2 Busque la referencia Fersa en la tabla Aplicación por número de parte (pag ---), y verifique la aplicación.

Applications Catalog

Catálogo de Aplicações / Catálogo de Aplicaciones



Experts in Bearing Solutions





Automotive Catalog 2011

Catálogo Automotivo 2011

Catálogo de Automoción 2011



Bearings for Commercial Vehicles

Rolamentos para Veículos Comerciais

Rodamientos para Vehículos Comerciales



Bearings General Catalog

Catálogo Geral de Rolamentos

Catálogo General de Rodamientos

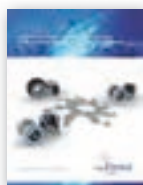

Hubs for Commercial Vehicles. Technical Sheets

Unidades de Cubo de Roda. Fichas Técnicas

Mazas para Vehículo Industrial. Fichas Técnicas



Fersa Technic

Fersa Technic

Fichas Técnicas Fersa

The contents of this publication are the copyright of Fersa Bearings and may not be reproduced (even extracts) unless prior written permission is granted. Every care has been taken to ensure the accuracy of the information contained in this publication but no liability for any loss or damage whether direct, indirect or consequential arising out of the use of the information contained herein.

Despite our best efforts to ensure the accuracy of the information contained in this document, errors or omissions cannot be completely ruled out. We disclaim any and all responsibility for such unintentional errors or omissions.

O conteúdo desta publicação é propriedade da Fersa Bearings e não pode ser reproduzido (mesmo que parcialmente) sem autorização prévia por escrito. Foram tomadas todas as medidas para se garantir a exatidão das informações contidas nesta publicação, mas não nos consideramos responsáveis por qualquer perda ou dano, tanto diretos como indiretos ou consequentes resultantes do uso das informações contidas neste documento.

Apesar do nosso esforço para garantirmos a exatidão dos dados deste documento, declinamos qualquer responsabilidade por eventuais erros ou omissões.

El contenido de esta publicación es propiedad de Fersa Bearings y no puede reproducirse (incluso parcialmente) sin autorización previa por escrito. Todos los datos se han tomado para garantizar la exactitud de la información contenida en esta publicación, pero no se hace responsable por cualquier pérdida o datos, ya sean directos, indirectos o consecuentes resultantes del uso de la información contenida en este documento.



A pesar de nuestro esfuerzo para asegurar la exactitud de los datos de este documento, declinamos toda responsabilidad sobre posibles errores u omisiones

Brand Index

Índice de Marcas

Índice de Marcas

AGCO MAXION	
	
Colheitadeira Combinada MF1130 - Arrozadeira * 5650 - Arrozadeira	4
Colheitadeira Combinada Automotriz (1170DS * 1175DS) * 1630 Arrozadeira * 3640 Arrozadeira * 5650 * MF 220A * 220CBD * 220STD * MF 310CBD * 310STD * 210 * 210S * 220 * 310	4
Diversos	8
Roçadeira MF 880	8
Tratores MF 235 (4x4) Antigo * MF 235 Moderno * 250 * 265 * MF265 RD * 270 * 274 * 275 * 285 * 290 * MF 292 (4x4) * 295 * 296 * 299	8
Tratores MF (50X * 55X * 65R * 65X * 85 * 85X * 95 * 95X)	10

AGRALE	
	
Diversos	12
M80 * M85 * M90	12
Tratores 4100 * 4200 * 4300 * T145 * T146 * T415 * T420	12
TX 1600 * TX 1200	13
	
CHASSI MA 12.0E-TRONIC * MA 12.0SB E-TRONIC * MA 12.0 LE E-TRONIC	42
CHASSI MA 8.5E-TRONIC * MA 9.2E-TRONIC * MA 9.2 GREEN E-TRONIC * MA 7.9E-MEC	42
	
7500	216
6000E-MEC * 6000E-TRONIC FURGOVAN * 8000E-MEC FURGOVAN * 8500E-MEC * 8500CD-EMEC * 8500E-TRONIC 9200E-TRONIC	216

ALFA ROMEO	
	
Alfa 145	114
Alfa 164	114
Alfa 2300	114



ASIA	
	
Topic	114
Townner	114

AUDI	
	
A3 * S3 * TT	115
A4	115

BALDAN	
	
Arado Escarificador AETC * AETH	14
Arado Fixo AF	14
Arado Fixo de AIVECAS AAFL * AAFT	14
Arado Reversível ARH	14
Arado Subsolador ASDACR * ASDADR * ASDAH	14

Arado Subsolador ASTH	14
Carpideira CED Tandem * Carpideira Fixa Leve	15
Grade Aradora GRS * GTCR * GCRTI * GR * GRI * GRPI * GSPA * GRP * CRI	15
Grade Laranjeira GLCRL	15
Grade Niveladora NVAM * NIVAP * NVCR * SNVAM * SNVAP * SP	15
Grade super pesada GSPCR	15
Roçadeira CPL * RD1300 * RD1500 * RD1700 * RPU 1700 * RP1300 * RPP * RPD 3000 * RDU 1500 * RDU1700 * RP 1500 * RP 1700 * RPU 1300 * RPU 1500 * RPD 2700 * RPD 2250	15
Roçadeira RD 2250 * RD 2700 * RD3000 * RDD	16
Semeadeira SD 5000 * Terraceador de Arrasto TACR	16

CBT	
	
2070 * 2080 * 2100 * 2105 (4x2) * 2400 * 2400 (4x4) * 2500 * 2600	17
Todos	17
Tratores 1000 * 1000 (4x4) * 1020 * 1020 (4x4) * 1065 * 1065 (4x4) * 1090 * 1105	17
Tratores 8060 (4x2) * 8060 (4x4) * 8240 * 8240A * 8260 * 8440 * 8450	19

CHRYSLER	
	
1800	116
Cherokee * Gran Cherokee	116
Crossfire	116
D 100	116
Dakota	116
Dart	116
Dart K	116
Gran Sedan	117
Le Baron	117
Magnum	117
New Yorker	117
Phantom	118
PT Cruiser	118
Shadow	118
Spirit	118
Volare K	118
	
D-600 * PD-600	217
Ram 6500	217



CITRÖEN	
	
AX * ZX	119
C3	119
Xantia (2.0 8V*16V)	119
Xsara	119
Xsara Picasso (1.6 8V* 1.8 16V * 2.0 8V*16V)	119
ZX (1.6 8V* 1.8 8V* 2.0 8V * 2.0 16V)	119

BRAND INDEX

ÍNDICE DE MARCAS

ÍNDICE DE MARCAS

DAEWOO	
	
Cielo	120
Espero	120
Lanos	120
Nubira	120
Racer	120



DINA	
	
300 Serie	43
434 17570 Shuttle Bus	43
500 Serie	43
Citus 11000 * 9500	44
D-Avante Plus * D-Dorado	44
DPC311774 * DPT231770 * DPC311970 * DPT311770 * DPT351970 * DPT352171 * DPT352172 * DPX281770	44
DPX311970	45
F11 * F12 * F14	45
Marco Polo	45
Paradiso * Quadro	46
Viaggio	46
	
400	186
451	186
311 * 312 * 314 * 362 * 315G * 316G * 317G6 * 318G * 319G * 321C * 323G	186
431K * 432K * 432J * 432J1 * 432J2	186
433 16070	186
455 OF	186
500 * 501	187
541 * 542	187
555 OF	187
651 * 653 * 654 * 661 * 741	188
654 21071	188
	
551	220
743	222
761	222
776	223
9400	224
300 HTQ Serie	219
400 Serie	219
500 HTQ Serie	219
531 K * 532 J	219
552 Q	220
553 19072 * 555 19070 * 661 25070 * 743 00300	220
604 G1 * 604 G3 * 604 L1 * 604 L5 * 631 K1 * 631 K3 * 661 C1 * 661 G1 * 661 G2 * 661 G3	221
650 19570 Cab Over	221
702 * 707	221
751 Multi Torque	222
861 K	223
D9 160 * D12 160 Cab Over	224
DCE 522570 * DCP 311970 * DCP 311 771 * DCP 351972	224

DODGE	
	
Atos	121
Attitude	121

Caravan	121
D150	121
D250	121
D350	121
H100	122
Neon	122
Ram 1500	122
Ram 2500	122
Ram 3500	123
Ram 4000	123
Ram Charger	123
Ram Van * Wagon 1500	123
	
1400 TD	225
400 * 450 * 700 * 750 * 900 * 950	225

FAMSA	
	
DC 10264 Autocar	226
DC 9964 Autocar	226
F 1314 * F 1317	226
F 1521	227
L1100 * L1200 * L1300 * L1400 * L1500 * L1600 * L2121	227

FAW	
	
F1 Sedan	124
F4	124



FIAT	
	
147	125
Brava	125
Doblò	125
Ducato	125
Elba	125
Fiorino	125
Idea	126
Marea * Marea Turbo * Marea Weekend	126
Marea * Marea Weekend	126
Oggi	126
Palio * Palio Weekend * Siena	126
Panorama	127
Pick-up	127
Prêmio	127
Spazio	127
Stilo	127
Strada	127
Tempra	128
Tipo	128
Uno	128
	
130 (76...)	228
130 OD (78...)	228
180 C * C3 * L * N * N3 (71...)	228
190 (77...)	229
70 (77...) * 80	230
FNM 2000 * 2150	230

FNM 210 C * CM * LN (71...76)	230
FNM D-11000 (58...72)	231
FNM D-9500 (50...57)	232
FNM V-15 (69...74)	233

FNH

	
923-4	20
Colheitadeiras 4040 * 5030 * 5050 * 8040 * 8055 * TC55 * TC57 * CA1530	20
Diversos	22
Todos	22
Tratores 4600 * 4610 * 4630 * 5600 * 5610 * 5630 * 6600 * 6610 * 6630 * 7610 * 7630 * 7810 * 7830 * 8030 * 8BR	22

FORD

	
B-800	47
	
Belina * Belina II * Corcel * Corcel II	129
Belina I (...78) * Corcel I (...78)	129
Belina II (79...) * Corcel II (79...)	129
Contour	129
Cougar	130
Courier	130
Del Rey * Pampa	130
Escape	1331
Escort	131
Escort Hobby	131
Excursion	131
Expedition	132
Explorer	132
F 100	132
F 1000 (79...)	132
F 150 (Mx)	135
F 2000	133
F 2000 (80...)	133
F 250 (Mx)	135
F 350	133
F 350 (Mx)	136
F 400	134
F 4000	134
F 4000 (75...)	134
F 450 (Mx)	137
Fiesta	137
Focus	137
Fusion	137
Galaxie 500	138
Ghia	138
Grand Marquis	138
Ikon	138
Jeep	138
Jeep Willys (4X2 * 4X4) (60...83)	138
Ka	139
Landau	139
Limited	139
Microbus	139
Mustang	140
Ranger	140
Royale	140

Rural	141
Rural (4X2 * 4X4)	141
Scala	141
Sierra (L * XR3 * S)	142
Taurus	142
Thunderbird	142
Topaz	142
Verona	142
Versailles	143
Windstar	143

FORD (NA & CA)

	
F-350 * P-350	243
F-350 Super Duty	243
F-450 * F-450 Super Duty	243
F-550 Super Duty	243
F-600 * B-600	244
F-700	244
F-800	245
LM-700	245
LT-800	245

FORD (SA)

	
Cargo 1113 * 1114 * 1116 * 1117	234
Cargo 1215	234
Cargo 1313 * 1314 * 1317 * 1317E	235
Cargo 1415 * 1416	236
Cargo 1422 * 1514 * 1517 * 1517E * 1615 * 1615T * 1617 * 1618 * 1618T * 1619 * 1621 * 1622 * 1717E * 1722 * 1722E * 2216 * 2217 * 2218 * 2218T * 2319 * 2322 * 2324 * 2422 * 2422E * 2425 * 2428E * 2630 * 3224 * 3530 * 4030	237
Cargo 814	238
Cargo 815 * 815 E	239
F 100 (61...80 Diesel) * F 600 (56...77 Gas.) * F 700 (77...80) * F 750 (72...77) * 750 * 2000 * 4000	239
F 11000 * F 12000	240
F 13000 * F 14000 * F 16000	241
F 19000 (77...) * F 21000 * F 22000	241
F 7000 * FT 7000 * FT 8000 (77...80) * F 8000 * F 8500 (77...79) *	242
FT 8500	242

FREIGHTLINER

	
Argosy	246
C-120 * Columbia * Coronado * CST 120	246
FC 70	246
FC 80	247
FL 106	247
FL 112 6X4	247
FL 112QR 6X4	247
FL 60	248
FL 70	248
FL 80 * FL 80 QR 4X2	249
FLD 120	249
FS 65	250
L-112	251
MT45 * MT45A * M2 52K (6X2)	251

BRAND INDEX

ÍNDICE DE MARCAS

ÍNDICE DE MARCAS

GENERAL MOTORS	
	
A-C-D (10*14*15*20*40) * Bonanza * Veraneio * D1000	144
Astra	144
Aveo	144
Blazer	144
Blazer * Gran Blazer	144
C 1500	145
C 2500	145
C 3500	145
Caprice	145
Caravan * Opala	145
Celta * Classic * Corsa * Corsa Sedan * Pick-up Corsa	146
Chevette * Chevette Junior * Chevy 500 * Marajó	146
Chevy	147
Corsa	147
Corsa (hatch * pick-up * sedan)	147
Corsa Novo * Meriva * Montana	147
D 10	147
D 20 (Bonanza * Veraneio)	147
D 40	148
Express Van	148
Ipanema* Kadett * Monza (1.8 * 2.0)	148
Luv	148
Marajó (1.0 * 1.4 * 1.6)	148
Meriva	149
Monza * Kadett * Ipanema	149
Omega * Omega Suprema (2.0 * 2.2 * 3.0 * 4.1)	149
Omega * Suprema	149
Optra	149
P 30	150
S 10	150
S 10 (2.2 * 2.4 * 2.5 * 2.8 TD * 4.3)	150
S 10 * Blazer	150
Silverado	151
Silverado 2500	151
Silverado 3500	151
Suburban	152
Tigra	152
Tornado	152
Vectra	152
Zafira (1.8 * 2.0)	152

GENERAL MOTORS (NA & CA)	
	
C-3500	254
Kodiak	254

GENERAL MOTORS (SA)	
	
6-100 (4X2) * 6-150 * 12-170 (L*S) (4X2) * 14-190 (77...) (4X2) * 15-190 (77...) (4X2) * 16-220 (4X2)	252
A-C-D (60 * 70 * 80 * 90 * 99 Turbo) * 3500 Heavy Duty	253

GURGEL	
	
BR 800	153

Honda	
	
Civic	153

HYUNDAI	
	
H100	153
HR	153

INTERNATIONAL	
	
3000 RE	47
4700 FBC * 4700 FE (4X2) * 4700 SCD * 4700 SCD (444 * 466)	47

INTERNATIONAL (NA & CA)	
	
4700	256
7400	256
4200 VT 365 * 4300 DT 466 / 195 HP	256
4400-215HP (4X2) * 4400-250HP * 4400-285HP * 4400-300HP	257
4900 DT 466E	257
4900-210HP * 4900-215HP * 4900-250HP * 4900-300HP	257
9200 * 9200i * 9400 * 9400i * Day Cab * Day Cab DDC	258

INTERNATIONAL (SA)	
	
4700 (4X2) * 4900 (16 ton.)	255

IVECO	
	
160 E21	258
Daily I 59-12 * Turbo Daily (...12/99)	258
Eurotrakker * Power Star 450 E37T * Eurotech E37	258

JEEP	
	
Comanche	153

JOHN DEERE	
	
Colheitadeiras CA1165 * CA1175 * CA1185 * CA1450 * CA1550-02 * CA1550-03	24
Colheitadeiras CA9650 * CA9750 STS	24
Diversos	25
Plantadeiras PL 803 * PL805	24
Plantadeiras PL 9200 * PL 9209 * PL9211	24
Tratores 5403 * 5600 Aeroportuário * 5605 * 5705 * 6605 * 7500 Aeroportuário * 7505	25

KENWORTH	
	
T 600 (Aerocab * B * Modular)	260
T2000	259
T300 (4X2 * 6X4)	259
T450 * T450 B * T450 W	260
T800 Aerocab * T800 Modular * SHW (Short hood wide) * HB Aerocab * BSH Aerocab * SH (6X4 * 8X4)	260
W900 * W924	261

KIA	
	
Besta (2.2 * 2.7 * GS)	153
Sportage (2.0 * 2.2)	153

LADA	
	
1600	154
Laika (1.6)	154
Niva	154
Samara	154

LAND ROVER	
	
Defender 112	155
Defender 114	155

LINCOLN	
	
MKX	155

MACK	
	
CH Day Cab * CH Premium * CH Select * CH Elite * CX Vision	262
RD 688 S * RD 690	262

MAN	
	
18-260 * 310 * 360 * 410 * 460	48

MARCHESAN	
	
Arado de Aivecas Helicoidais AAH	27
Arado de Aivecas Reversível AAR	27
Arado de Aivecas Reversível Pesado AARP	27
Arado Fixo AF * Arado Fixo Canavieiro AFC * Arado Fixo Leve AFL	27
Arado Reversível AR * Arado Reversível com Pistão de Reversão ARPR	27
Arado Reversível AR * Arado Reversível com Pistão de Reversão ARPR	27
Arado Subsolador com Desarme Automático AST * MATIC E 500	27
Arado Subsolador Hidráulico Tatu AST * Arado Subsolador Mecânico Tatu AST	27
Cobertura para Plantio Direto CPD * CPD2	27
Distribuidor de Calcário & Adubo DCA 2 2500 * DCA 2 5500 * DCA 2 7500 * DCA DC 5500 * DCA DC 7500 * DCA DC 2500	28
Distribuidor de Calcário * Composto Orgânico DCC0 10500 * DCC0 2500 * DCC0 5550 * DCC0 7500	28
Grade Aradora Controle Remoto GACM	28
Grade Aradora Controle Remoto Offset	28
Grade Aradora GA	28
Grade Aradora Hidráulica GAH	28
Grade Aradora Intermediária Controle Remoto GAICR * GAICR 300	28
Grade Aradora Intermediária GAI	28
Grade Aradora Mecânica GAM * GATCR	29
Grade Aradora Pesada com Pneus GAPCW	29
Grade Aradora Pesada Controle Remoto GAPCR * GAPM	29
Grade Aradora Pesada GAP * GAPC	29
Grade Aradora Super Pesada com Pneus GASPCW	29
Grade Aradora Super Pesada Controle Remoto GASPCR * GAPM	29

Grade Hidráulica * Grade Niveladora * Grade Niveladora Flutuante * GNL	29
Grade Niveladora Controle Remoto GNCR * GND * GNDH * GNLCR * Grade Niveladora Flutuante Mecânica GNFM * GNM	29
Guincho Agrícola Tatu Giratório GAT G * GATR	30
Perfurador de Solo PS	30
Plantadeira Direta de Cereais * Pastagem PDCP	30
Plantadeira Hidráulica Tatu PHT * PHT Suprema	30
Plantadeira Ultra Flex * Ultra Flex Suprema	30
Raspadeira Agrícola STA * STA 3 RT	30
Roçadeira RC 2 1300 * RC 2 1500 * RC 2 1700	30
Roçadeira RC 2 2600 CL * LSL * RC 2 3100	30
Roçadeira RC 2 4500 * Roçadeira de Arrasto RCA 3100 * RCA E 3400	30
Semeadeira Direta Articulada SDA 3	31

MASA	
	
502 UX	49
Jaguar * Condor * Géminis * Halcón * Strada * Premier 2030F	49
S 5000 * S 5002 * S 2030	49
S500T * S500U * S501U	50
Ursus	50

MASSEY FERGUSON	
	
MF50X * MF55X * MF65R * MF65X * MF85 * MF85X * MF95 * MF95X	31

MAZDA	
	
Mazda3	155
Mazda5	155
Mazda6	155





MBB	
	
180 D	156
Sprinter	156

MERCEDES BENZ	
	
1018 MBO	189
1113 OF * 1115 OF	189
1215 OF * 1217 OF	191
1313 OF * 1314 OF * 1315 OF * 1316 OF * 1317 OF * 1318 OF *	192
1319 OF * 1320 OF	192
1417 OF * 1419 OF * 1421 OF	193
1421 OMC	195
1517 OF * 1518 OF * 1520 OF	197
1618 OF	200
1620 OF * 1621 OF	202
1714 OF * 1721 OF * 1722 OF	203
MBO 1017	204
MBO 1018 44	204
MBO 1019 44 Boxer	205
MBO 1217	205
MBO 1219 52 Boxer	206
MBO 1417	206
MBO 1418 60	206
MBO 1419 60 Boxer	207
MBO 1621	207

BRAND INDEX

ÍNDICE DE MARCAS

ÍNDICE DE MARCAS

OF 1313 * OF 1314 * OF 1315 * OF 1316 * OF 1317 * OF 1318 51	207
OMC 1418 51 * OMC 1418 60	207
OMC 1419 51	207
OMC 1421 51	208
OMC 1425 51 Allegro	208
	
Classe A	157
MB 180	157
Sprinter 313 * 413	157
Sprinter 316	157
Sprinter 415	157
Sprinter 416	157
Sprinter 515	158
MERCEDES BENZ (CA)	
	
O 1835	80
O 362HL	80
O 370 R * O 370 RS * O 370 RSD	80
O 370 U	80
O 371 U * O 371 UL * O 371 UP	80
O 817	80
OH 1113	81
OH 1419 * OH 1420 * OH 1421	81
OH 1517 * OH 1518 * OH 1519 * OH 1520 * OH 1521	81
OH 1524 * OH 1525	81
OH 1625 L * OH 1630 L * OH 1635 L * OH 1636 L	82
	
LO 1417 59	209
LO 709 * LO 710 * LO 712	209
LO 914	209
OF 1111 * OF 1113 * OF 1114 * OF 1115 * OF 1116 * OF 1117 * OF 1118	209
OF 1215 * OF 1217	210
OF 1320	210
OF 1416 * OF 1417 * OF 1418 * OF 1419 * OF 1420 * OF 1421	210
OF 1513 * OF 1514	210
OF 1517 * OF 1518 * OF 1519 * OF 1520 * OF 1521 * OF 1524 * OF 1525	210
OF 1618 * OF 1620 * OF 1621 * OF 1625 * OF 1628 * OF 1630 * OF 1635 * OF 1636	211
OF 1714 * OF 1718 * OF 1721 * OF 1725	211
	
L 1312	277
L 1524 * L 1525	277
L 1614 * L 1615	277
L 1620	277
L 1714 * L 1715 * L 1718 * L 1720 * L 1721 * L 1722 * L 1723 * L 1724 * L 1728	278
L 1819 * L 1820 * L 1833	278
L 2213 * L 2214 * L 2215 * L 2216 * L 2217 * L 2219 * L 2220	278
L 2222 * L 2225 * L 2314 * L 2318 * L 2325	278
L 2414 * L 2418 * L 2420 * L 2423 * L 2424 * L 2428	278
L 331	279
L 608 * L 708 * L 709 * L 710 * L 712 * L 714 * L 715 * L 718	279
L 809 * L 812 * L 814 * L 817	279
L 911 * L 912 * L 913 * L 914	279
LA 1313 * LA 1314 * LA 1315 * LA 1316 * LA 1317 * LA 1318 * LA 1319 * LA 1320	280
LA 1418 * LA 1419 * LA 1420	280
LA 2213 6X6 * LA 2214 6X6 * LA 2215 6X6 * LA 2216 6X6 * LA 2217 6X6 * LA 2219 6X6 * LA 2220 6X6 * LA 2225 6X6	280

LAK 1113 * LAK 1116 * LAK 1118	280
LAK 1313 * LAK 1314 * LAK 1315 * LAK 1316 * LAK 1317 * LAK 1318 * LAK 1320	280
LAK 1418 * LAK 1419 * LAK 1420	280
LAK 1524 * LAK 1525	280
LAK 1819 * LAK 1820 * LAK 1833	281
LAK 2013 6X2 * LAK 2014 * LAK 2016 * LAK 2017	281
LAK 2213 * LAK 2214 * LAK 2215 * LAK 2216 * LAK 2217 * LAK 2219 * LAK 2220 * LAK 2222 * LAK 2225	281
LAS 1111	281
LAS 1113 * LAS 1114 * LAS 1116 * LAS 1118	281
LAS 1313 * LAS 1314 * LAS 1315 * LAS 1316 * LAS 1317 * LAS 1318 * LAS 1319 * LAS 1320	281
LB 1116 * LB 1117 * LB 1118	281
LB 1314 * LB 1315 * LB 1316 * LB 1317 * LB 1318 * LB 1319 * LB 1320	281
LB 1524 * LB 1525	282
LB 2220 * LB 2222 * LB 2225	282
LB 2314 * LB 2318 * LB 2325	282
LB 2414 * LB 2418 * LB 2420 * LB 2423 * LB 2424 * LB 2428	282
LG 1524 * LG 1525	282
LG 1819 * LG 1820	282
LG 2013 6X2	283
LG 2213 * LG 2214 * LG 2215 * LG 2216 * LG 2217 * LG 2219 * LG 2220 * LG 2222 * LG 2225	283
LK 1113 * LK 1114 * LK 1116 * LK 1117 * LK 1118	283
LK 1214 * LK 1215 * LK 1217 * LK 1218	283
LK 1313 * LK 1314 * LK 1315 * LK 1316 * LK 1317 * LK 1318 * LK 1319 * LK 1320 * LK 1321	283
LK 1414 * LK 1416	283
LK 1524 * LK 1525	283
LK 1614 * LK 1615 * LK 1617 * LK 1618 * LK 1620 * LK 1621 * LK 1622 * LK 1623 * LK 1625 * LK 1630 * LK 1633 * LK 1634	284
LK 1714 * LK 1715 * LK 1718 * LK 1720 * LK 1721 * LK 1722 * LK 1723 * LK 1724 * LK 1728	284
LK 2013 6X2 * LK 2014 * LK 2016 * LK 2017 * LK 2024 * LK 2036 * LK 2042	284
LK 2213 * LK 2214 * LK 2215 * LK 2216 * LK 2217 * LK 2219 * LK 2220 * LK 2222 * LK 2225	284
LK 2314 * LK 2318 * LK 2325	285
LK 2414 * LK 2418 * LK 2420 * LK 2423 * LK 2424 * LK 2428 * LK 2429	285
LK 2629 * LK 2635 * LK 2638 * LK 2654	285
LK 312	285
LK 3238 6X4 KS	285
LO 1417 59	285
LO 608 * LO 708	286
LO 709 * LO 710 * LO 712	286
LO 914	286
LP 1114 * LPO 1114 * LS 1114	286
LP 1116 * LPO 1116 * LS 1116	287
LP 1117 * LPO 1117 * LS 1117	287
LP 1118 * LPO 1118 * LS 1118	287
LP 1312	287
LP 1313 * LP 1314 * LP 1315 * LP 1316 * LP 1317 * LP 1318 * LP 1320	287
LP 1520 * LPK1520 * LPS1520	287
LP 1524 * LPK1524 * LPS1524 * LS 1524	287
LP 1525 * LPK1525 * LPS1525 * LS 1525	287
LP 321 * LPK 321	288
LPK 331 * LP S331	288
LPO 1313 * LPO 1314 * LPO 1315 * LPO 1316 * LPO 1317 * LPO 1318 * LPO 1320	288
LS 1314 * LS 1315 * LS 1316 * LS 1317 * LS 1318 * LS 1319	288
LS 1524 * LP1524 * LPK1524 * LPS1524	288

LS 1929 * LS 1930 * LS 1932 * LS 1933 * LS 1934 * LS 1935 *	
LS 1937 * LS 1938 * LS 1939 * LS 1941 * LS 1942 * LS 1944 *	288
LS 1945 * LS 1951	
LS 2013 * LS 2014 * LS 2016 * LS 2017 * LS 2024 * LS 2036 *	289
LS 2042	
LS 2220 * LS 2222 * LS 2225 * LS 2314 * LS 2325	289
LS 2629 * LS 2635 * LS 2638 * LS 2654	289
OF 1111 * OF 1113 * OF 1114 * OF 1115 * OF 1116 * OF 1117 *	289
OF 1118	
OF 1215 * OF 1217	289
OF 1320	289
OF 1416 * OF 1417 * OF 1418 * OF 1419 * OF 1420 * OF 1421	290
OF 1513 * OF 1514	290
OF 1618 * OF 1620 * OF 1621 * OF 1625 * OF 1628 * OF 1630 *	290
OF 1635 * OF 1636	
OF 1714 * OF 1718 * OF 1721 * OF 1725	291

MERCEDES BENZ (NA)

Multitego IBC 1842 * IBC 2242 * OC 500	77
O355	77
O371R * O371RS * O371RSD	77
O400R * O400RS * O400RSD * O400RSE * O400RSL * MP105 *	78
MP 108DD * MP120 * MP180 DDMP120	
O500M 1728 * O500R 1735	78
OH1417 * OH1418	79
OMC1628 58 Andare	79
L1113 * L1114 * L1116 * L1117 * L1118	263
L1214 * L1215 * L1217 39 * L1217 52 * L1218 52	263
L1313 * L1314 * L1315 * L1316 * L1317 * L1318 * L1319 * L1321	263
L1414 * L1416	264
L1417 52	264
L1418 39 * L1418 52 * L1418 60 * L1419 59 * L1420 * L1422	264
L1518 52	265
L1617 59	265
L1618	266
L1619 52	266
L1621 52	267
L1621 54 * L1621 59 * L1621 60 * L1621 70 * L1622 * L1623 *	267
L1625	
L1630 * L1632 * L1633 * L1634	267
L1924 * L1929 * L1930 * L1932 * L1933 * L1934 * L1935 * L1937 *	268
L1938 * L1939 * L1941 * L1942 * L1944 * L1945 * L1951	
L2013 * L2014 * L2016 * L2017 * L2024 * L2036 * L2042	268
L2121 54	268
L2221	268
LK1417 34	269
LK1418 39 * LK1418 52	269
LK1420 * LK1422	270
MBO 1017	270
MBO 1018 44	270
MBO 1019 44 Boxer	271
MBO 1217	271
MBO 1219 52 Boxer	272
MBO 1417	272
MBO 1418 60	272
MBO 1419 60 Boxer	273
MBO 1621	273
OF 1313 * OF 1314 * OF 1315 * OF 1316 * OF 1317 * OF 1318 51	273
OMC 1418 51 * OMC 1418 60	274
OMC 1419 51	274
OMC 1421 51	275

OMC 1423 51 Torino	275
OMC 1425 51 Allegro	275

MERCEDES BENZ (SA)

1113 (LPO*OH) * 1114 (LPO) * 1115 L (OH) * 1118 (LPO)	52
1313 OH * 1314 OH * 1315 OH * 1316 (OH*OHL) *	
1316 G (OH*OHL) * 1317 OH * 1318 OH * 1319 OH *	53
1320 (OH*OHL)	
1418 OH * 1419 OH * 1420 (OH*OHL) * 1421 OHL	55
1517 OH * 1518 OH * 1519 OH * 1520 OH * 1521 OH	58
1621 L (OH) * 1623 LG (OH) * 1625 (OH) * 1625 L (OH) *	61
1628 L (OH) * 1630L (OH) * 1635 (OH) * 1636 L (OH)	
1721 L (OH)	62
321 H (O) * 321 HL (O) (58...71)	65
326 (O)	66
352 HL (O) (...74)	67
355 (O)	68
355 HL (O) (...74)	69
362 O	69
364 HL (O) (...74)	71
364 O	70
370 * 371 (RS * RSD * RST * ST * U * UP) (O)	71
400 (R * RS * RSD * RSL) (O)	73
500 (O*M*R)	74
608 D * E (L*LO) * 708 D * E (L*LO) * 709 L * 710 L * 712 L	74
812 (LO) * 912 L	75
915 (LO) * 915 C	76
1018 MBO	293
1111 (L*LA*LAK* LAS*LK*LS)	294
1113 (L*LA*LAK*LAS*LK*LP*LS*LP) * 1114 * 1114 (L*LK*LP) *	294
1116 (L*LA*LAK*LAS*LB* LK*LS) * 1118 (L*LK*LP)	
1113 OF * 1115 OF	296
1214 C * 1214 K * 1214 (L*LK*LS) * 1215 * 1215 C *	298
1215 (L*LA*LK) * 1218 * 1218 R (L)	
1215 (OF) * 1217 (OF)	299
1313 (L*LA*LAK*LB*LK*LS) * 1314 (L*LA*LAK*LB*LK*LS) *	301
1316 (L*LA*LAK*LAS*LB*LK*LS) * 1317 (L*LA*LAK*LK*LS)* 1319 (L)	
1313 OF * 1314 OF * 1315 OF * 1316 OF * 1317 OF * 1318 OF *	303
1319 OF * 1320 OF	
1414 * 1414 (K*L*LA*LAK*LK) * 1418 * 1418 (E*K*R) *	305
1418 (L*LA*LAK*LK*R(LK)) * 1419 (L*LK*LS) * 1420 (L*LK*LS)	
1417 OF * 1419 OF * 1421 OF	307
1421 OMC	310
1513 (L*LA*LAK*LB*LG*LK*LS) * 1514 (L*LK*LS) *	
1516 (L*LA*LAK*LB*LG*LK*LS) * 1517 (L*LK) * 1518 (L*LK*LS) *	313
1519 (L*LAK*LB*LG*LK*LS) * 1520 (L*LK*LP*LPK*LPS*LS) * 1521 L *	
1524 * 1525 (L*LK*LS)	
1517 OF * 1518 OF * 1520 OF	315
1614 * 1615 (L*LK*LS) * 1615 * 1618 M * 1618 (L*LK*LS) * 1619 (L)	318
1618 OF	321
1620 OF * 1621 OF	326
1620(L*LK*LS) * 1620 6X2 51 (L) * 1621 (L*LK*LS) * 1622(L*LK*LS) *	
1623 (L*LS) * 1625(L*LK*LS) * 1630 (L*LK*LS) * 1632 (L*LS) *	324
1633(L*LK*LS) * 1634 (L*LS) * 1635 L	
1714 * 1714 (L*K*LK) * 1715 * 1718 * 1718 (A * AK) * K * 1720 L *	330
1721 * 1721 S * 1721 (L*LK) * 1722 S * 1723 * 1723 S * 1725 L	
1714 OF * 1721 OF * 1722 OF	628
1819 (L*LAK*LB*LG*LK*LS) * 1820 (LG)	332
1924 (LS) * 1924 A (LS) * 1929 (L*LK*LS) * 1930 (LS) * 1932 (LS) *	
1933 (LS) * 1934 (LS) * 1935 (L*LS) * 1938 * 1938 S * 1938 (L*LS) *	334
1941 (L*LS) * 1944 S * 1945 (L*LS)	
2013 (L*LA*LAK*LB*LG*LK*LS) * 2013 6X2 (L) * 2014 (L*LB*LK) *	336
2016 (LB*LK) * 2017 (L*LB*LK)	

BRAND INDEX

ÍNDICE DE MARCAS

ÍNDICE DE MARCAS

2213 (L*LB*LK*LS) * 2213 6X6 (LA) * 2214 * 2215 (L*LB*LK*LS) *	
2216 (L*LA*LAK*LB*LG*LK*LS) * 2217 (L*LB*LK*LS) *	337
2219 (L*LA*LAK*LB*LG*LK*LS) * 2220 * 2222 * 2225 (L*LB*LK*LS)	
2314 (L*LB*LK*LS) * 2318 (L*LB*LK*LS) * 2325 (L*LB*LK*LS)	341
2414 (6X4) * 2414 (L) * 2418 (L*LB*LK) * 2420 (L*LB*LK) *	
2423 B 6X4 * 2423 K 6X4 * 2425 6X6 (LA) * 2425 (L*LB*LK) *	343
2428 6X4	
Axor (2625 * 2628 * 2629 (LK*LS) * 2631 (B*K*L) * 2632 * 2635 (B*K*L) * 2635 (L*LK*LS) * 2638 (L*LK*LS) * 2640 * 2641 * 2643 * 2644 * 2826 * 2828 * 2831) * Actos (2646 * 2648 * 2650 * 2651 * 2653 * 2654 (L*LK*LS) * 2657 * 2658 * 2644) * Atego (2628 (B*K) * 2625)	345
2629 LS	346
2635 (L*LK*LS)	347
312 (L*LK*LP) 51...58	348
321 (LAP*LAPK*LAPS*LP* LPK*LPS) 51...71	349
321 LAP * LAPK * LAPS * LP * LPK * LPS	349
3238 (6x4) K*S	350
331 (L*LPK*LPS) 60...68	350
608 (L*LO) * 708 (L*LO) * 809 (LO*OF) * 812 (LO*OF) * 814 LO * 817 O * 914 LO * 709 * 710 * 712 * 712 C * 811 * 911 L * 912 * 913 * 914 * 914 C * 917	292
615 (LO) * 715 C	351

MERCURY	
	
Mariner	158

MITSUBISHI	
	
L 200	159
L 300	159
Montero * Pajero	159
Pajero I (2.5 * 2.8 * 3.0 * 3.5)	159

MOTOR COACH	
	
F11 * F11A	83
F12	83
F14	83
P11 * P12	83
P14	84

NISSAN	
	
Altima	160
Aprio	160
D21	160
Datsun	160
Frontier	160
Hikari	160
Ichivan	160
Lucino	161
Maxima	161
Micra	161
Pathfinder	161
Pick Up 2200	161
Pick Up 2500	161
Pick Up 2700 4 x 4	162
Platina	162
Quest	162
Samurai	162

Sentra	162
Terrano	162
Titan	162
Tsubame	162
Tsuru I	163
Tsuru II	163
Tsuru III	163
X-Terra	163

PEUGEOT	
	
205	164
206	164
207	164
306	164
405	164
406	164
Grand Raid	164
Partner	164

PONTIAC	
	
G3	165
Matiz	165



RANDON	
	
RK 425 B	212
RK 425 B	212

RENAULT	
	
Clio	166
Kangoo	166
Laguna	166
Laguna (2.0)	166
Megane	166
R 21	166
R 23	166
R 24	166
Scénic	166
Traffic (2.1 * 2.2 * 2.5)	166
Traffic	167
Twingo	167

SCANIA	
SCANIA (NA & CA)	
	
K 113 IB (4X2) Busscar	85
K 114 IB (4X2) Busscar	85
K 114 IB (4X2) LB 340 Irizar	85
K 114 IB (4X2) NB 340 K	85
K 124 CA (4x2) NB 340K	85
K 124 IB (4X2) Vissta Bus	86
L 114 IB (4X2) LB 340 Urbanuss	86
L 94 VB (4X2) 220HP Urbanuss	86
T 113 H (6X4) Paradiso	86

	
LA 94 UB (4X2) * LA (6X4) * LB * NA	352
P 114 CB (6X4) * NA 340	352
P 94 CB (4x2 * 6x2 * 6X4)	352
P 94 DB (4X2) * P 94 DB (6X2) * NA 220 * NA 260	352
R 114 LA (4X2) * NA 340	352
R 124 GA (4X2) * NA400	353
T 124 GA (6X4) * T 124 LA (6X4) * NA400	353

SCANIA (SA)

	
101 (L*LS) * 111 (B) * 111 Articulado (B)	87
110 (B)	88
110 (L*LS)	89
111 (L*LS*LT)	90
115 * 116 BR	91
140 (LK*LKS)	92
K 113	94
K 124 CA (6x4 * 6x2)	94
K 124 EB (4X2 * 6X2) * K 124 IB (4X2 * 6X2 * 8X2)	95
K 94 IB (4X2)	95
P 93 * R 113 * R 143 * T 113	97
	
112 (F*K*S)	354
75 * 76 (B*L*LS)	355
94I * 94H * 94U * P94 CB (6x4 * 4x2) * 114L * P114 * T114 CB (6x4 * 4x2) * 124E * R124 * K124 CA (6x4 * 6x2) * T124 * P124 (CA * CB (6x4 * 4x2) * 164 * P230 * P270 * P310 * P340 * P420 * R380 * R420 * R480	357
Diversos	358
F 113 * L 113 * K 113	358
P 114 * R 124 * T 114 CB 6x4 * 4x2 * T 124	359
P 114 GA (4X2) * R 114 GA (4X2 * 6X4) * T 114 GA (4X2) * T 114 LA (6X2)	360
P 124 CA (6X4) * P 124 GA*GB (4X2) * R 124 LA (4X2) * T 124 GA (4X2 * 6X4) * T 124 LA (4X2)	360
P 94 CB (4x2 * 6x2 * 6X4)	360
P 94 GA * GB (4X2)	363
R 112 (81...)	364
R 142 MA (4X2)(81...)	366
Série 4 (4X2)	367
T 142 E (6X4)	368
Truck	369

SEAT

	
Cordoba	168
Ibiza	168
Inca	168
Toledo	168
Toledo II	168

SKODA

	
Octavia	168

STERLING

	
AT 9500	370
L 7500	370

LT 7500	370
LT 9500	370
M 8500 Acterra	371
ST 9500 Silver Star	371

SUDISA

	
EA11ED	212
EA12EF	212
EA12TD	212
EA12TF	212
EA4	212
EA9EM	212
EA9TM	212
EE4 * EH4	212

TOYOTA

	
Bandeirante	169
Hilux	170
Land Cruiser	170
RAV4	170

VALTRA - VALMET

	
Tratores 60 * 60 ID * 62 * 65 * 65 Cafeeiro * 68 * 68 Cafeeiro * 78 * 80 * M80 * 85 * 85ID * 86 * 86 ID * 88 * 88 ID	32
Tratores 110 ID * 110ID II * 118 * 118 (4x4) * 128 * 128 (4x4)	33
Tratores 870 CN * CK	34
Tratores 360 D * 600 D * 621 ID	35
Tratores 685 * 685C (4x4) * 785 * 785C (4x4) * 880 Cafeeiro * 880 (4x4) * 885 * 980 (4x4) * 985 * 985F * 1180 * 1184	36
Tratores 1280 * 1284 * 1580 * 1780 * 1780 (4x4) * 1380 * 1680 * 1880 * 118 * 128 * 138 * 148 * 148 (4x4)	37
Empilhadeira - 7000	38
Todos	38

VOLKSWAGEN

	
1600 * 1600TL	171
Apollo	171
Atlantic	171
Bora	171
Bosch * Wapsa (35 * 45 * 55 * 65 A)	174
Brasília	172
Brasília (1500 * 1600) * Fusca (1300 * 1300L * 1500 * 1600) * Variant I	172
Cabrio	172
Caddy	172
Caribe	172
Combi	172
Corrado	173
Corsar	173
Crossfox	173
Derby	173
Fusca	173
Gol	173
Gol (1.3 * 1.6)	174
Gol * Parati	173
Gol * Parati (AP 1.6 * 1.8 * 2.0)	174
Gol * Parati (motor AT)	174

BRAND INDEX

ÍNDICE DE MARCAS

ÍNDICE DE MARCAS



Gol * Parati (motor CHT)	174
Gol * Parati * Voyage * Saveiro	174
Golf	175
Golf A4	175
Golf IV	175
Jetta	175
Karmann Ghia	175
Kombi	176
Kombi (1500 * 1600)	176
Logus	177
Logus (1.6 * 1.8)	177
Lupo	177
New Beetle	177
Panel	177
Passat	177
Passat (1.5 * 1.6 * 1.8)	178
Passat 2.8 VR10	178
Pointer	178
Pointer (1.8 * 2.0)	179
Polo	179
Polo Classic	179
Santana * Santana Quantum (1.6 * 1.8 * 2.0)	180
Saveiro	180
Saveiro * Voyage	180
Sedan	180
TC	181
Van	181
Variant	181
Variant II	181
Vento	182
	
11-130 * 11-140 * 11-160	372
12-140 * 12-140 H * 12-140 T * 12-170 BT	372
13-130 * 13-150 * 13-170 * 13-180E * 13-190 (77...)E * 13-210	373
14-140 * 14-150 * 14-170 BT * 14-180 * 14-200 * 14-210 * 14-220	373
15-170 * 15-170E * 15-180 * 15-180E * 15-180 OD * 15-190 (77...) * 15-190 (77...)EOD	374
16-170 * 16-180 * 16-200 * 16-210 * 16-220 CO * 16300	371
18-310 TITAN * 18-310 OT	374
19-320 TITAN Tractor Constellation	374
24-220 * 24-250 * 24-250 Constellation * 24-250E * 26-220 * 26-260E * 26-300	375
31-260E * 35-300 * 40-300	375
5-140E Delivery * 5-140 EOD Volksbus	375
6-80 * 6-90 (P*S)	375
7-90 S * 7-100 * 7-110 S	376
D 1400 TD * Volksbus	376
E 13 * E 21	377

VOLKSWAGEN (NA & CA)	
	
15-210	99
17-210	99
23-250	99
4-140210	99
8-150	99

VOLKSWAGEN (SA)	
	
17-180 * 17-210 * 17-210 OD * 17-210 EOD * 17-220 * 17-220 Tractor * 17-240 OT * 17-250 Constellation * 17-250 OE * 17-260 EOT * 17-300 * 17-310 TITAN * 17-230 EOD	100
22-140 * 22-210 * 23-210 * 23-220 * 23-250 E * 23-310 TITAN	100
7-100 * 8-120 * 8-140 (CE*CO) * 8-150 * 9-150 OD	100
8-100 * 8-140 (CO * CE) * 8-120 * 8-120 OD * 8-150 (E * EOD * OD) * 9-150 (EOD * OD)	101

VOLVO	
VOLVO (NA & CA)	
	
7550	102
9700	102
Busscar dos y tres ejes	102
C 10 * C 11	103
C 11R * C 12R	103
U 12 * U 18 Articulado	104

	
Autocar * VHD 64B (6X4)	378
Autohailer 6X4	378
B 10 R * B 12 B * B 12 R * B 58 * B 58 BR * B 7 R * B 9	378
FH 12	378
NE 64 6X4 * NR 64 T	378
VNL 64T * 420 6X4 * 430 * 610 6X4 * 630 * 660 * 670 * 673 * DAY * DAY CAB	379
WG 64	379

VOLVO (SA)	
	
B 10M BR	105
B 10R * B 12B * B 12R * B 58 * B 58BR * B 7R * B9	106
B 58	107
B 58 BR (...Chassi 304120)	108
	
FH 12 * FH 16	380
N * NL 10 BR * N * NL 12 BR * N 10BR Mark II * NL 10BR 6x2	381
NH 12 * FM 12	382
VM 17 * VM 23 * VM 210	383

Numerical Index

Índice Numérico

Índice Numérico

03

Fersa®	Pag.
11 BC	399, 403, 412, 413, 414
11590 / 11520	135, 138, 141, 386, 393, 403, 409, 414, 602, 606, 607, 609
12168 / 12303	186, 386, 396, 403, 410, 414, 582, 583, 602, 606
12175 / 12303	186, 386, 396, 403, 410, 414, 582, 583, 602, 606
1380 / 1328	225, 386, 393, 403, 409, 414, 583, 602, 606
14116 / 14276	217, 386, 394, 403, 410, 414, 582, 602, 606
14131 / 14276	134, 138, 141, 386, 394, 403, 410, 414, 607, 609
14585 / 14525	386, 394, 403, 410, 413, 414
15101 / 15245	121, 122, 123, 124, 135, 136, 139, 243, 244, 386, 394, 403, 410, 414, 587, 602, 606
15103 S / 15243	145, 150, 386, 394, 403, 410, 414
15106 / 15250 X	42, 216, 225, 238, 239, 240, 253, 375, 376, 386, 394, 403, 410, 414, 581, 583, 584, 586, 589, 599, 602, 606
17887 / 17831	386, 396, 403, 410, 413, 414
25577 / 25523	132, 135, 138, 141, 386, 396, 403, 410, 415, 607, 609
25580 / 25520	248, 250, 254, 256, 386, 396, 403, 410, 415, 588, 589, 590, 602, 606
25581 / 25520	100, 238, 373, 375, 386, 396, 403, 410, 415, 587, 599, 607, 609
25590 / 25520	187, 205, 206, 207, 208, 217, 219, 244, 248, 250, 251, 254, 256, 263, 264, 265, 266, 268, 269, 270, 271, 272, 274, 283, 386, 396, 403, 410, 415, 582, 587, 588, 589, 590, 593, 595, 602, 606
25590 / 25522	8, 42, 47, 78, 79, 101, 103, 204, 205, 206, 207, 208, 216, 224, 225, 236, 237, 238, 239, 240, 245, 249, 250, 251, 252, 253, 254, 255, 256, 257, 259, 263, 270, 271, 272, 273, 274, 275, 375, 376, 377, 386, 396, 403, 410, 416, 581, 582, 583, 584, 586, 587, 588, 589, 590, 593, 595, 599, 602, 606, 607, 609
25877 / 25820	43, 44, 186, 187, 204, 205, 224, 247, 248, 251, 270, 271, 386, 394, 403, 410, 417, 582, 583, 588, 593, 595, 602, 606
25877 / 25821	100, 216, 234, 235, 236, 237, 238, 252, 373, 375, 386, 395, 403, 410, 417, 581, 586, 587, 589, 599, 602, 606, 607, 609
25880 / 25820	186, 219, 244, 386, 395, 403, 410, 417, 582, 583, 587, 602, 606
2689 / 2631	216, 386, 384, 403, 410, 417, 581, 602, 606
2780 / 2720	216, 386, 394, 403, 410, 417, 581, 602, 606
2789 / 2720	28, 29, 217, 225, 240, 241, 242, 252, 253, 377, 386, 395, 404, 410, 417, 582, 583, 586, 589, 599, 602, 606
28682 / 28622	122, 123, 386, 397, 404, 411, 418,
28985 / 28921	222, 257, 386, 398, 404, 411, 418, 582, 583, 590, 602, 606
29675 / 29630	222, 257, 386, 398, 404, 411, 418, 582, 583, 590, 602, 606
29685 / 29620	25, 386, 398, 404, 411, 418, 602, 606

Fersa®	Pag.
32020 XF	20, 25, 54, 56, 59, 62, 63, 76, 77, 79, 80, 81, 85, 86, 93, 95, 97, 207, 210, 211, 247, 263, 264, 265, 266, 267, 268, 269, 270, 273, 277, 278, 280, 282, 283, 284, 287, 288, 289, 290, 291, 298, 300, 302, 304, 306, 308, 309, 311, 313, 316, 320, 322, 325, 327, 329, 331, 334, 343, 354, 358, 359, 362, 365, 367, 368, 386, 399, 404, 412, 418, 437, 438, 588, 593, 594, 597, 602, 604, 605, 606, 609
32023 F	12, 17, 18, 23, 36, 53, 55, 57, 60, 64, 66, 67, 68, 69, 70, 71, 72, 73, 75, 99, 100, 129, 130, 190, 192, 193, 195, 197, 199, 201, 204, 229, 231, 233, 234, 235, 237, 238, 293, 296, 297, 299, 301, 303, 305, 307, 309, 312, 315, 318, 321, 324, 330, 332, 337, 340, 342, 345, 372, 373, 374, 386, 393, 404, 409, 418, 419, 581, 585, 587, 593, 599, 602, 604, 607, 609
32024 F	17, 18, 24, 27, 30, 31, 32, 36, 55, 57, 60, 61, 64, 66, 67, 68, 69, 70, 71, 72, 73, 75, 78, 80, 99, 100, 165, 192, 193, 195, 197, 199, 201, 204, 229, 230, 231, 233, 234, 235, 237, 238, 293, 296, 299, 301, 303, 305, 307, 309, 310, 312, 315, 318, 321, 324, 330, 332, 337, 340, 342, 345, 351, 372, 373, 374, 386, 393, 404, 409, 420, 421, 585, 587, 593, 599, 602, 604, 607, 609
32025 F	7, 12, 16, 18, 20, 22, 24, 27, 30, 31, 52, 55, 56, 57, 60, 62, 65, 66, 67, 68, 69, 71, 72, 73, 80, 165, 190, 193, 194, 195, 196, 197, 199, 201, 202, 295, 297, 303, 305, 306, 307, 309, 310, 311, 312, 315, 318, 320, 323, 325, 327, 336, 340, 351, 386, 394, 404, 409, 421, 422, 581, 593, 602, 604, 607, 609
32026 F	14, 15, 24, 52, 55, 56, 62, 65, 66, 67, 68, 69, 71, 72, 73, 77, 80, 99, 169, 190, 193, 194, 196, 201, 202, 295, 297, 303, 305, 306, 309, 311, 320, 323, 325, 327, 386, 394, 404, 410, 422, 423, 593, 602, 604, 607, 609
32027 F	12, 14, 15, 16, 23, 24, 27, 28, 29, 30, 31, 37, 86, 114, 129, 130, 154, 230, 386, 395, 404, 410, 423, 424, 581, 585, 602, 604, 607, 609
32028 F	5, 12, 14, 18, 19, 20, 21, 22, 32, 33, 34, 35, 36, 37, 159, 160, 161, 162, 163, 386, 395, 404, 410, 424, 425, 581, 602, 604
32029 F	16, 24, 386, 396, 404, 410, 425, 602, 604
320210 F	9, 10, 11, 14, 15, 18, 19, 24, 25, 27, 29, 386, 397, 404, 410, 425, 602, 604
320211 F	386, 397, 404, 411, 413, 425
320212 F	28, 29, 386, 398, 404, 411, 602, 604
320213 F	233, 386, 398, 404, 411, 425, 585, 607, 609
320214 F	54, 192, 302, 304, 380, 386, 398, 404, 411, 425, 593, 595, 600, 601, 607, 609
320216 F	351, 386, 399, 404, 411, 425, 593, 595, 607, 609
320217 F	87, 88, 89, 90, 92, 93, 94, 96, 97, 102, 354, 356, 358, 360, 362, 364, 365, 366, 368, 380, 381, 383, 386, 399, 404, 411, 426, 596, 597, 600, 602, 604, 607, 609
320220 F	335, 345, 346, 348, 350, 386, 399, 404, 412, 426, 592, 593, 594, 602, 604, 607, 609
320222 F	229, 231, 386, 399, 404, 412, 426, 585, 607, 609

Fersa®	Pag.
30302 F	17, 18, 33, 53, 65, 66, 189, 190, 293, 294, 295, 297, 348, 349, 350, 386, 393, 404, 409, 426, 593, 602, 604, 607, 609
30303 F	386, 393, 404, 409, 413, 426
30304 F	129, 130, 173, 176, 386, 393, 404, 409, 426, 602, 604
30305 F	12, 13, 31, 173, 175, 176, 386, 394, 404, 410, 427, 581, 602, 604
30306 F	74, 80, 106, 108, 110, 153, 169, 176, 209, 230, 277, 279, 285, 286, 287, 292, 348, 378, 386, 394, 404, 410, 427, 585, 591, 593, 594, 595, 600, 602, 604, 607, 609
30307 F	153, 169, 232, 386, 395, 404, 410, 427, 585, 602, 604, 607, 609
30308 F	24, 52, 53, 54, 55, 56, 58, 61, 63, 65, 66, 67, 68, 69, 70, 72, 74, 75, 189, 190, 192, 193, 194, 195, 196, 197, 200, 202, 203, 209, 286, 292, 293, 294, 295, 296, 301, 303, 305, 308, 310, 311, 313, 316, 318, 319, 321, 324, 326, 328, 330, 336, 338, 341, 344, 349, 350, 386, 395, 404, 410, 427, 428, 593, 594, 602, 604, 607, 609
30309 F	52, 53, 54, 55, 56, 65, 189, 192, 193, 194, 195, 196, 200, 230, 293, 294, 296, 301, 303, 305, 307, 309, 310, 319, 321, 338, 349, 386, 396, 404, 410, 428, 429, 585, 592, 593, 602, 604, 607, 609
30312 F	17, 33, 34, 35, 37, 52, 65, 66, 67, 68, 77, 85, 94, 95, 189, 190, 209, 277, 280, 281, 283, 285, 286, 287, 288, 289, 293, 294, 295, 297, 343, 348, 349, 350, 352, 353, 355, 360, 361, 363, 367, 386, 398, 404, 411, 429, 430, 592, 593, 594, 597, 602, 604, 608, 609
30313 F	59, 77, 78, 198, 314, 317, 351, 386, 398, 404, 411, 430, 593, 602, 604, 608, 609
30314 F	85, 94, 95, 96, 352, 353, 355, 360, 361, 363, 367, 386, 398, 404, 411, 430, 597, 598, 602, 604, 606, 609
31306 F	386, 394, 404, 410, 430, 606, 609
31308 F	32, 33, 36, 87, 88, 89, 91, 169, 170, 381, 386, 396, 404, 410, 430, 431, 600, 602, 604, 608, 609
31309 F	87, 88, 89, 91, 96, 356, 361, 364, 386, 396, 404, 410, 431, 596, 587, 602, 604, 608, 609
31311 F	351, 386, 397, 404, 411, 431, 593, 595, 608, 609
31312 F	19, 32, 34, 36, 85, 86, 87, 88, 89, 91, 92, 93, 95, 96, 97, 228, 229, 231, 232, 263, 352, 353, 354, 356, 357, 358, 359, 362, 364, 367, 368, 378, 380, 381, 383, 386, 398, 404, 411, 431, 585, 591, 593, 596, 597, 600, 602, 604, 608, 609
31313 F	62, 64, 72, 78, 91, 233, 320, 323, 325, 327, 329, 331, 335, 345, 386, 398, 404, 411, 432, 585, 592, 593, 597, 602, 604, 608, 609
31314 F	96, 229, 231, 356, 362, 364, 386, 398, 404, 411, 432, 585, 586, 597, 602, 605, 608, 609
31315 F	380, 381, 383, 386, 399, 404, 411, 432, 600, 602, 606, 608, 609
31594 / 31520	47, 78, 79, 103, 132, 135, 138, 141, 144, 148, 151, 205, 206, 207, 208, 224, 236, 237, 245, 249, 250, 251, 254, 256, 257, 259, 263, 270, 271, 272, 273, 274, 275, 386, 395, 404, 410, 432, 433, 582, 586, 587, 588, 589, 590, 591, 593, 602, 606, 608, 609
31597 / 31520	222, 386, 395, 404, 410, 433, 582, 583, 602, 606
3196 / 3120	187, 220, 386, 394, 404, 410, 433, 582, 583, 602, 606
32006 XF	386, 394, 404, 410, 413, 433
32007 XF	147, 152, 386, 395, 404, 410, 433, 608, 609
32008 XF	153, 154, 155, 386, 395, 404, 410, 433, 602, 605, 608, 609
32009 XF	125, 126, 128, 157, 166, 386, 396, 404, 410, 433, 602, 605, 608, 609

Fersa®	Pag.
32010 XF	125, 156, 157, 386, 397, 404, 410, 433, 602, 605, 608, 609
32011 XF	17, 157, 158, 337, 351, 386, 397, 404, 410, 433, 593, 594, 602, 605
32012 XF	17, 336, 386, 397, 404, 411, 433, 593, 595, 602, 605
32014 XF	56, 76, 306, 308, 311, 337, 351, 386, 398, 404, 411, 433, 434, 593, 594, 602, 605
32015 XF	234, 235, 236, 237, 343, 380, 386, 399, 404, 411, 434, 587, 593, 595, 600, 601, 602, 605, 608, 609
32016 XF	292, 358, 386, 399, 404, 411, 434, 593, 595, 597, 602, 605
32017 XF	56, 64, 79, 80, 81, 102, 203, 209, 210, 211, 264, 266, 267, 269, 270, 277, 278, 280, 281, 282, 283, 284, 286, 287, 290, 291, 306, 308, 311, 329, 331, 333, 336, 380, 381, 382, 383, 386, 399, 404, 411, 434, 435, 591, 593, 594, 600, 602, 605, 608, 609
32018 XF	54, 56, 59, 61, 63, 72, 77, 78, 79, 80, 81, 207, 210, 211, 263, 264, 265, 266, 267, 268, 269, 270, 273, 277, 278, 280, 282, 283, 284, 285, 287, 289, 290, 298, 300, 302, 304, 306, 308, 311, 313, 316, 320, 322, 325, 329, 331, 336, 339, 342, 343, 345, 346, 348, 386, 399, 404, 411, 435, 436, 592, 593, 594, 602, 605, 608, 609
32019 XF	19, 32, 34, 36, 72, 74, 201, 320, 323, 343, 386, 399, 404, 411, 437, 592, 593, 602, 605, 608, 609
32020 XF	20, 54, 56, 59, 62, 63, 76, 77, 79, 80, 81, 85, 86, 93, 95, 97, 207, 210, 211, 247, 263, 264, 265, 266, 267, 268, 269, 270, 273, 277, 278, 280, 281, 282, 283, 284, 287, 288, 289, 290, 291, 298, 300, 302, 304, 306, 308, 309, 311, 313, 316, 320, 322, 325, 327, 329, 331, 334, 343, 354, 358, 359, 362, 365, 367, 368, 386, 399, 404, 412, 418, 437, 438, 588, 593, 594, 597, 602, 604, 605, 608, 609
32021 XF	43, 50, 83, 84, 104, 223, 245, 357, 386, 399, 404, 412, 439, 593, 587, 597, 602, 605
32022 XF	56, 90, 306, 308, 311, 336, 337, 348, 354, 365, 366, 386, 399, 404, 412, 439, 592, 593, 594, 597, 598, 602, 605, 608, 609
32024 XF	334, 386, 399, 404, 412, 439, 593, 595, 602, 605
3206 B	382, 386, 394, 402, 408, 439, 600, 602, 605
3207 B 2RS / C3	106, 108, 109, 439, 600
32205 BF	60, 199, 315, 318, 340, 386, 394, 404, 409, 439, 593, 595, 608, 609
32205 F	60, 63, 199, 315, 318, 346, 347, 348, 386, 394, 404, 410, 439, 593, 602, 605, 608, 609
32206 F	14, 15, 24, 153, 157, 233, 386, 394, 404, 410, 439, 585, 586, 602, 605, 608, 609
32207 F	14, 90, 91, 93, 95, 153, 357, 359, 362, 386, 395, 404, 410, 440, 597, 602, 605, 608, 609
32208 F	19, 32, 33, 34, 36, 37, 55, 79, 80, 81, 88, 89, 90, 91, 92, 94, 98, 191, 194, 195, 209, 210, 263, 264, 269, 270, 279, 283, 286, 289, 290, 292, 298, 299, 305, 308, 310, 355, 359, 366, 367, 369, 386, 395, 404, 410, 440, 441, 593, 594, 595, 597, 602, 605, 608, 609
32210 F	5, 7, 14, 15, 16, 17, 18, 19, 25, 27, 28, 29, 30, 31, 32, 33, 34, 35, 36, 37, 56, 74, 80, 157, 158, 191, 194, 196, 209, 210, 211, 263, 279, 286, 289, 291, 292, 298, 300, 305, 308, 311, 386, 397, 404, 410, 441, 442, 594, 595, 602, 605
32211 F	75, 386, 397, 404, 411, 442
32212 F	14, 15, 27, 28, 29, 65, 66, 77, 102, 277, 281, 285, 287, 288, 349, 350, 386, 398, 404, 411, 442, 593, 594, 602, 605, 608, 609
32213 F	106, 107, 108, 228, 229, 231, 233, 378, 386, 398, 404, 411, 443, 585, 586, 600, 602, 605, 608, 609
32214 F	65, 66, 77, 191, 233, 277, 285, 287, 299, 300, 348, 386, 398, 404, 411, 443, 585, 593, 594, 602, 605, 606, 609
32215 F	67, 386, 399, 404, 411, 443

Fersa®	Pag.
32216 F	15, 29, 52, 57, 59, 65, 66, 67, 68, 189, 190, 191, 194, 196, 198, 212, 281, 293, 294, 295, 297, 299, 300, 306, 309, 311, 314, 317, 349, 350, 351, 386, 399, 404, 411, 443, 444, 594, 602, 605, 608, 609
32218 F	15, 29, 59, 81, 87, 88, 89, 92, 93, 97, 99, 198, 211, 212, 277, 279, 281, 282, 284, 287, 288, 290, 291, 314, 317, 351, 354, 356, 358, 365, 367, 368, 383, 386, 399, 404, 411, 444, 594, 595, 596, 597, 600, 601, 602, 605, 608, 609
32219 F	93, 107, 109, 230, 279, 288, 351, 368, 382, 386, 399, 404, 411, 444, 585, 594, 596, 597, 600, 602, 605, 608, 609
32220 F	90, 91, 93, 95, 357, 359, 362, 386, 399, 404, 412, 445, 596, 597, 602, 605, 609
32304 F	75, 114, 129, 130, 141, 230, 292, 386, 393, 404, 409, 445, 585, 592, 594, 602, 605, 608, 609
32305 F	75, 292, 349, 387, 394, 404, 410, 445, 594, 602, 605, 608, 609
32306 F	52, 75, 76, 81, 88, 89, 90, 91, 92, 94, 98, 190, 209, 277, 279, 285, 286, 287, 292, 295, 297, 348, 349, 355, 359, 366, 367, 369, 387, 394, 404, 410, 445, 446, 592, 593, 596, 597, 602, 605, 608, 609
32307 F	52, 54, 59, 65, 66, 67, 68, 81, 189, 190, 192, 198, 252, 280, 283, 293, 294, 295, 297, 302, 304, 314, 317, 336, 339, 348, 349, 350, 387, 395, 404, 410, 446, 589, 594, 602, 605, 608, 609
32308 BF	94, 95, 357, 359, 361, 362, 387, 396, 404, 410, 446, 447, 597, 602, 605
32308 F	85, 86, 87, 88, 89, 91, 93, 94, 97, 228, 230, 231, 352, 353, 354, 356, 357, 358, 359, 361, 365, 366, 367, 368, 387, 396, 404, 410, 447, 585, 596, 597, 602, 605, 608, 609
32309 F	59, 61, 63, 72, 73, 74, 77, 78, 86, 93, 94, 97, 105, 106, 107, 108, 198, 200, 202, 203, 229, 230, 268, 279, 287, 288, 314, 317, 319, 321, 322, 324, 326, 328, 330, 334, 338, 351, 354, 357, 358, 359, 360, 361, 365, 366, 368, 386, 396, 404, 410, 447, 448, 585, 592, 594, 596, 597, 602, 605, 608, 609
32310 F	61, 63, 64, 72, 73, 74, 77, 78, 79, 200, 201, 202, 203, 210, 211, 266, 267, 268, 277, 278, 284, 290, 291, 319, 320, 322, 323, 324, 326, 328, 329, 330, 331, 334, 335, 336, 344, 346, 347, 382, 387, 397, 404, 410, 448, 449, 591, 594, 600, 602, 605, 608, 609
32311 F	87, 88, 89, 91, 93, 94, 97, 228, 230, 231, 354, 356, 358, 359, 361, 365, 366, 368, 387, 397, 404, 411, 449, 450, 585, 586, 597
32312 F	86, 93, 94, 97, 102, 228, 229, 230, 232, 335, 345, 350, 354, 357, 358, 359, 360, 361, 365, 366, 368, 387, 398, 404, 411, 450, 585, 586, 594, 595, 596, 597, 602, 605, 608, 609
32313 BF	96, 356, 361, 364, 387, 398, 404, 411, 450, 596, 597, 602, 605, 608, 609
32313 F	229, 230, 231, 247, 387, 398, 404, 411, 450, 585, 586, 594, 595, 602, 605, 608, 609
32314 BF	62, 64, 72, 78, 80, 266, 267, 277, 284, 285, 288, 289, 290, 320, 323, 325, 327, 329, 331, 335, 345, 347, 387, 398, 404, 411, 451, 592, 602, 605, 608, 609
32315 BF	87, 88, 89, 91, 92, 93, 354, 365, 367, 368, 387, 399, 404, 411, 451, 597, 602, 605, 608, 609
32315 F	230, 231, 387, 399, 404, 411, 451, 586, 608, 609
32316 F	89, 91, 93, 95, 357, 359, 362, 387, 399, 404, 411, 451, 596, 597, 602, 605
33011 F	53, 54, 75, 76, 192, 209, 278, 279, 280, 281, 282, 283, 284, 286, 288, 289, 292, 301, 303, 332, 333, 337, 338, 341, 343, 387, 397, 404, 410, 452, 592, 594, 602, 605, 608, 609
33017 F	85, 86, 90, 95, 102, 352, 353, 357, 359, 361, 365, 366, 367, 387, 399, 404, 411, 452, 453, 597, 602, 605, 608, 609
33018 F	37, 85, 95, 352, 353, 357, 359, 361, 387, 399, 404, 411, 453, 597, 602, 605, 609

Fersa®	Pag.
33019 F	52, 54, 57, 59, 64, 67, 68, 70, 71, 72, 80, 190, 191, 193, 194, 196, 198, 201, 203, 204, 295, 297, 299, 300, 302, 304, 306, 309, 311, 314, 317, 320, 323, 329, 331, 332, 333, 335, 337, 339, 342, 344, 387, 399, 404, 411, 453, 454, 594, 602, 605, 608, 609
33020 F	54, 57, 59, 64, 72, 73, 74, 77, 78, 79, 191, 193, 194, 196, 198, 201, 204, 210, 263, 283, 289, 299, 300, 302, 304, 306, 309, 311, 312, 314, 317, 321, 323, 329, 332, 337, 339, 342, 344, 345, 346, 348, 387, 399, 404, 412, 454, 455, 592, 494, 595, 602, 605, 608, 609
33021 F	64, 72, 73, 74, 102, 201, 204, 321, 323, 329, 332, 387, 399, 404, 412, 455, 592, 594, 602, 605, 608, 609
33022 F	72, 288, 333, 335, 345, 346, 348, 350, 387, 399, 404, 412, 455, 592, 594, 595, 602, 605, 608, 609
33109 F	75, 81, 209, 211, 279, 286, 291, 292, 343, 387, 396, 404, 410, 455, 456, 592, 594, 602, 605, 608, 609
33110 F	382, 387, 397, 404, 410, 456, 600, 605, 609
33111 F	52, 75, 76, 80, 190, 209, 279, 286, 292, 295, 297, 333, 387, 397, 404, 410, 456, 594, 595, 602, 605, 608, 609
33112 F	54, 192, 301, 303, 333, 338, 341, 387, 397, 404, 411, 456, 594, 595, 602, 605, 609
33113 F	53, 192, 301, 303, 332, 338, 341, 343, 387, 398, 404, 411, 456, 594, 595, 606, 609
33114 F	336, 339, 342, 343, 387, 398, 404, 411, 457, 594, 595, 608, 609
33115 F	62, 63, 72, 266, 267, 277, 284, 320, 323, 325, 327, 329, 331, 334, 345, 346, 347, 348, 387, 399, 404, 411, 457, 592, 594, 602, 605, 608, 609
33116 F	57, 64, 73, 74, 79, 194, 196, 201, 204, 306, 309, 312, 321, 323, 329, 332, 335, 337, 344, 387, 399, 404, 411, 457, 594, 595, 602, 605, 609
33117 F	54, 57, 59, 64, 72, 73, 74, 77, 78, 80, 191, 193, 194, 196, 198, 201, 204, 299, 300, 302, 304, 306, 309, 312, 314, 317, 321, 323, 329, 332, 339, 342, 344, 345, 346, 348, 387, 399, 404, 411, 458, 592, 594, 602, 605, 608, 609
33205 F	17, 75, 81, 157, 158, 209, 211, 279, 286, 291, 292, 387, 394, 400, 404, 410, 458, 459, 594, 602, 605, 609
33207 F	76, 336, 351, 387, 395, 404, 410, 459, 592, 594, 602, 605, 609
33208 F	52, 54, 56, 59, 64, 91, 92, 94, 97, 190, 191, 192, 194, 196, 198, 201, 203, 252, 255, 295, 297, 299, 300, 302, 304, 306, 309, 311, 314, 317, 320, 323, 329, 331, 337, 339, 342, 343, 354, 358, 360, 364, 366, 368, 381, 387, 395, 404, 410, 459, 460, 589, 594, 595, 597, 600, 602, 605, 608, 609
33209 F	53, 54, 192, 301, 302, 303, 304, 332, 333, 337, 338, 341, 343, 387, 396, 402, 410, 460, 592, 594, 602, 605, 608, 609
33210 F	53, 54, 57, 64, 82, 191, 192, 194, 196, 201, 204, 209, 211, 265, 266, 267, 277, 278, 279, 280, 281, 282, 283, 284, 285, 286, 288, 289, 290, 298, 299, 301, 303, 306, 309, 311, 320, 323, 329, 331, 332, 333, 335, 337, 338, 341, 343, 387, 397, 404, 410, 460, 461, 592, 594, 602, 605, 608, 609
33212 F	43, 95, 102, 192, 301, 303, 332, 338, 341, 343, 357, 359, 362, 380, 382, 387, 398, 404, 411, 461, 462, 592, 594, 597, 600, 602, 605, 608, 609
33213 F	52, 54, 57, 59, 64, 190, 191, 193, 194, 196, 198, 201, 204, 211, 278, 284, 291, 295, 297, 299, 300, 302, 304, 306, 309, 311, 314, 317, 320, 323, 329, 331, 337, 339, 342, 343, 387, 398, 404, 411, 462, 463, 592, 594, 602, 605, 608, 609
33214 F	54, 57, 64, 81, 193, 194, 196, 201, 204, 283, 288, 302, 304, 306, 309, 311, 320, 323, 329, 331, 333, 335, 344, 387, 398, 404, 411, 463, 594, 602, 605, 608, 609

Fersa®	Pag.
33215 F	52, 54, 57, 59, 64, 67, 68, 70, 71, 72, 80, 190, 191, 193, 195, 196, 198, 201, 204, 295, 297, 299, 300, 302, 304, 307, 309, 312, 314, 317, 321, 323, 329, 332, 333, 335, 337, 339, 342, 344, 387, 399, 404, 411, 463, 464, 592, 594, 595, 602, 605, 608, 609
33275 / 33472	43, 217, 219, 244, 387, 398, 404, 411, 464, 582, 583, 587, 602, 606, 609
33281 / 33462	42, 225, 243, 372, 387, 398, 404, 411, 464, 581, 584, 587, 599, 602, 606
33287 / 33462	18, 36, 204, 217, 225, 240, 244, 246, 248, 353, 370, 372, 387, 398, 404, 411, 464, 465, 582, 583, 586, 587, 588, 589, 595, 599, 602, 606
3382 / 3320	55, 81, 191, 193, 195, 264, 298, 299, 305, 307, 310, 387, 395, 404, 410, 465, 591, 595, 602, 606
33885 / 33822	58, 197, 200, 313, 316, 318, 321, 332, 334, 338, 341, 345, 346, 347, 387, 396, 404, 410, 465, 591, 595, 602, 606
33889 / 33822	58, 102, 105, 106, 107, 108, 197, 200, 313, 316, 319, 321, 334, 338, 341, 346, 347, 387, 397, 404, 410, 465, 591, 595, 602, 606
33895 / 33821	187, 220, 387, 397, 404, 410, 466, 583, 602, 606
33895 / 33822	75, 209, 279, 286, 292, 387, 397, 404, 410, 466, 592, 593, 594, 595, 602, 606
34274 / 34492 A	221, 387, 398, 404, 411, 466, 583, 602, 606
34306 / 34478	43, 248, 387, 399, 404, 411, 466, 583, 588, 602, 606
3585 / 3525	42, 217, 234, 236, 241, 372, 373, 387, 396, 404, 410, 466, 581, 582, 586, 599, 602, 606
3586 / 3525	25, 387, 396, 404, 410, 466, 602, 606
368 A / 362 A	42, 101, 144, 151, 216, 225, 230, 252, 375, 376, 387, 397, 404, 410, 466, 581, 583, 584, 585, 589, 599, 602, 606, 607, 609
368 A / 362 X	132, 147, 148, 387, 397, 404, 410, 466, 607, 609
368 S / 362	212, 387, 397, 404, 410, 466, 598, 602, 606, 609
37431 / 37625	387, 399, 404, 412, 413, 466, 609
37431 A / 37625	387, 399, 404, 412, 413, 466, 609
3775 / 3720	43, 387, 397, 404, 410, 466, 609
3780 / 3720	28, 29, 387, 397, 404, 410, 466, 602, 606, 609
3782 / 3720	24, 43, 44, 45, 46, 47, 49, 50, 78, 79, 83, 84, 99, 100, 102, 103, 104, 186, 187, 188, 204, 205, 206, 207, 208, 209, 210, 217, 218, 219, 220, 221, 222, 223, 224, 226, 227, 235, 237, 238, 245, 246, 247, 249, 250, 251, 252, 254, 256, 257, 259, 260, 261, 262, 263, 264, 265, 266, 267, 268, 269, 270, 271, 272, 273, 274, 275, 276, 286, 290, 370, 371, 373, 374, 375, 376, 377, 378, 379, 387, 396, 404, 410, 467, 468, 469, 470, 582, 584, 586, 587, 588, 589, 590, 591, 595, 598, 599, 600, 602, 606, 607, 609
387 / 382 A	225, 239, 242, 387, 397, 404, 411, 470, 583, 586, 587, 602, 606, 607, 609
387 A / 382 A	25, 100, 131, 133, 134, 135, 136, 137, 139, 140, 145, 148, 150, 151, 152, 212, 226, 252, 375, 376, 387, 397, 404, 411, 470, 471, 584, 589, 598, 602, 606, 607, 609
387 A / 382 S	218, 243, 387, 397, 404, 411, 471, 582, 586, 602, 606, 609
387 A / 383 A	387, 397, 404, 411, 413, 471, 609
387 AS / 382 A	243, 254, 387, 397, 404, 411, 471, 586, 587, 589, 602, 606, 609
388 A / 382	212, 387, 397, 404, 411, 471, 598, 602, 606, 609
39250 / 39412	243, 387, 398, 404, 411, 471, 587, 602, 606
395 A / 394 A	387, 398, 404, 411, 413, 471, 606
39580 / 39520	102, 106, 382, 387, 397, 404, 411, 471, 600, 602, 606
39581 / 39520	42, 217, 234, 372, 373, 387, 397, 405, 411, 471, 581, 582, 586, 587, 599, 602, 606

Fersa®	Pag.
39585 / 39520	122, 123, 387, 398, 405, 411, 471, 606
39590 / 39520	10, 26, 42, 43, 45, 47, 78, 79, 103, 186, 187, 188, 205, 206, 207, 208, 209, 210, 216, 217, 219, 220, 221, 224, 225, 227, 234, 236, 237, 240, 241, 242, 244, 245, 246, 247, 249, 250, 251, 252, 253, 254, 255, 256, 257, 259, 263, 264, 265, 269, 270, 271, 272, 273, 274, 275, 285, 290, 372, 373, 376, 377, 387, 398, 405, 411, 471, 472, 473, 581, 582, 583, 584, 586, 587, 588, 589, 590, 591, 595, 599, 602, 606
3982 / 3920	4, 15, 25, 27, 28, 29, 30, 32, 42, 99, 102, 134, 144, 151, 204, 216, 217, 225, 226, 230, 238, 239, 240, 244, 246, 248, 252, 270, 375, 376, 387, 398, 405, 411, 473, 474, 581, 582, 583, 584, 585, 586, 588, 589, 591, 592, 599, 602, 606
3984 / 3920	8, 9, 10, 23, 24, 25, 28, 29, 30, 31, 75, 76, 387, 398, 405, 411, 474, 602, 606
3994 / 3920	43, 220, 387, 398, 405, 411, 474, 582, 602, 606
42346 / 42584	50, 221, 387, 399, 405, 411, 474, 583, 602, 606
42350 / 42584	223, 387, 399, 405, 411, 474, 606
42368 / 42584	32, 33, 36, 387, 399, 405, 411, 474, 602, 606
42381 / 42584	17, 18, 35, 37, 43, 50, 219, 220, 223, 226, 234, 235, 236, 237, 248, 252, 270, 271, 372, 387, 399, 405, 412, 474, 475, 582, 583, 584, 586, 587, 588, 589, 591, 595, 599, 602, 606
42688 / 42620	225, 240, 387, 399, 405, 411, 475, 584, 586, 587, 602, 606
45284 / 45220	5, 103, 186, 208, 217, 219, 224, 225, 237, 240, 241, 242, 244, 245, 250, 253, 254, 259, 262, 275, 377, 387, 397, 405, 410, 475, 582, 583, 584, 587, 588, 589, 590, 591, 595, 599, 602, 606
45291 / 45220	122, 123, 124, 212, 387, 397, 405, 511, 476, 598, 602, 606
469 / 453	216, 243, 387, 397, 405, 411, 476, 581, 586, 587, 602, 606
469 / 453 X	243, 387, 397, 405, 411, 476, 586, 587, 602, 606
47487 / 47420 A	52, 54, 56, 59, 62, 63, 66, 69, 70, 72, 295, 297, 298, 300, 302, 304, 306, 308, 311, 313, 316, 320, 323, 325, 329, 331, 333, 336, 339, 387, 398, 405, 411, 476, 595, 606
47490 / 47420	387, 398, 405, 411, 413, 476, 606
47686 / 47620	42, 43, 45, 79, 186, 187, 188, 205, 206, 207, 208, 209, 210, 216, 217, 219, 220, 221, 225, 227, 234, 240, 241, 242, 244, 246, 247, 249, 250, 253, 255, 263, 264, 265, 269, 271, 272, 273, 274, 275, 285, 290, 372, 373, 387, 399, 405, 411, 476, 477, 581, 582, 583, 584, 586, 587, 588, 589, 595, 599, 602, 606
47890 / 47820	43, 45, 46, 49, 222, 223, 226, 250, 257, 259, 261, 387, 399, 405, 411, 478, 582, 583, 584, 588, 590, 591, 602, 606
482 / 472	364, 366, 368, 387, 398, 405, 411, 478, 596, 597, 608
495 A / 493	43, 219, 220, 221, 387, 399, 405, 411, 478, 582, 602, 606, 608
495 AX / 493	186, 244, 387, 399, 405, 411, 478, 582, 586, 587, 602, 606, 608
496 / 493	217, 219, 222, 223, 244, 387, 399, 405, 411, 478, 582, 586, 587, 602, 606
497 / 492 A	
497 / 493	26, 43, 47, 79, 88, 89, 90, 93, 217, 218, 219, 220, 221, 223, 226, 227, 244, 252, 254, 256, 257, 259, 263, 264, 265, 266, 267, 268, 269, 271, 272, 273, 274, 275, 285, 387, 399, 405, 411, 479, 480, 582, 584, 586, 589, 590, 591, 602, 606, 608, 609
498 / 492 A	59, 198, 278, 281, 284, 314, 317, 333, 337, 339, 387, 399, 405, 411, 480, 591, 592, 602, 606, 609
498 / 493	43, 217, 219, 244, 387, 399, 405, 411, 480, 582, 583, 586, 587, 602, 606, 609

Fersa*	Pag.
498 A / 492 A	387, 399, 405, 411, 480, 602, 606, 609
52400 / 52618	103, 104, 237, 248, 260, 387, 399, 405, 412, 480, 587, 588, 590, 591, 602, 606, 609
53178 / 53377	105, 109, 387, 396, 405, 410, 480, 609
537 / 532 X	378, 387, 397, 405, 410, 480, 600, 601, 602, 606, 609
55200 C / 55437	43, 47, 79, 103, 217, 218, 219, 220, 221, 227, 238, 244, 245, 248, 249, 254, 256, 257, 260, 263, 264, 265, 266, 267, 268, 269, 270, 271, 272, 273, 274, 275, 285, 387, 397, 405, 410, 480, 481, 582, 583, 584, 587, 588, 589, 590, 595, 602, 606, 609
55206 C / 55437	99, 104, 218, 245, 247, 248, 249, 251, 257, 387, 397, 405, 410, 481, 582, 587, 588, 590, 602, 606, 609
555 S / 552 A	245, 247, 248, 257, 261, 262, 370, 371, 378, 379, 387, 397, 405, 411, 481, 586, 587, 588, 590, 591, 598, 600, 601, 602, 606, 609
559 / 552 A	57, 59, 67, 68, 70, 71, 77, 81, 194, 196, 198, 270, 280, 306, 309, 311, 314, 317, 337, 339, 387, 398, 405, 411, 481, 482, 591, 593, 602, 606, 609
56425 / 56650	43, 47, 90, 93, 217, 219, 220, 221, 227, 244, 252, 254, 263, 264, 265, 266, 267, 268, 269, 271, 272, 273, 285, 387, 399, 405, 412, 482, 582, 583, 584, 587, 589, 590, 595, 602, 606, 608, 609, 610
567 / 563	43, 220, 221, 257, 260, 387, 398, 405, 411, 482, 582, 590, 602, 606, 610
580 / 572	18, 19, 26, 43, 44, 45, 46, 47, 49, 50, 51, 59, 79, 83, 84, 99, 100, 103, 104, 186, 188, 198, 207, 208, 212, 218, 219, 220, 221, 222, 223, 224, 226, 234, 235, 236, 238, 245, 246, 247, 248, 249, 250, 252, 255, 256, 257, 258, 259, 260, 261, 262, 264, 265, 266, 267, 268, 269, 273, 274, 276, 314, 317, 351, 370, 371, 373, 374, 375, 378, 379, 383, 387, 399, 405, 411, 482, 483, 484, 485, 582, 584, 586, 587, 588, 589, 590, 591, 592, 598, 609, 600, 602, 606, 608, 609, 610
580 / 572 F	458
581 / 572	223, 387, 399, 405, 411, 485, 582, 583, 602, 606
59162 / 59412	242, 387, 396, 405, 410, 485, 586, 587, 602, 606
59175 / 59412	239, 240, 242, 387, 396, 405, 410, 485, 587, 602, 606
594 / 592	23, 100, 107, 109, 228, 232, 235, 238, 241, 252, 373, 374, 380, 381, 383, 387, 399, 405, 412, 485, 585, 589, 599, 600, 602, 606, 608, 609
594 / 592 A	100, 107, 109, 228, 232, 235, 238, 241, 252, 373, 374, 380, 381, 383, 387, 399, 405, 412, 485, 585, 589, 599, 600, 602, 606, 608, 610
594 A / 592 A	26, 43, 44, 45, 46, 47, 49, 50, 51, 79, 83, 84, 99, 100, 103, 104, 212, 218, 219, 220, 222, 223, 224, 234, 236, 237, 245, 246, 247, 248, 249, 250, 251, 255, 256, 257, 258, 259, 260, 261, 262, 264, 265, 266, 267, 268, 269, 273, 275, 276, 370, 371, 374, 375, 378, 379, 387, 399, 405, 412, 485, 486, 487, 582, 586, 587, 588, 589, 590, 591, 598, 599, 600, 602, 606, 608, 610
598 A / 592 A	50, 79, 221, 222, 223, 260, 274, 275, 388, 399, 405, 411, 487, 582, 583, 590, 602, 606
598 A / 593 X	54, 57, 59, 65, 66, 67, 68, 70, 71, 77, 198, 281, 283, 284, 288, 289, 302, 304, 307, 309, 312, 314, 317, 337, 339, 388, 399, 405, 411, 488, 591, 592, 602, 606
6000 2RS / C3	388, 393, 401, 407, 413, 488
6001	86, 129, 130, 145, 150, 178, 388, 393, 401, 407, 488, 608, 610
6001 2RS / C3	145, 150, 388, 393, 401, 407, 488, 607, 610
6001 C3	178, 388, 393, 401, 407, 488, 608, 610
6002 2RS / C3	388, 393, 401, 407, 413, 488
6003 2RS	130, 137, 139, 140, 144, 147, 152, 174, 178, 180, 388, 393, 401, 407, 413, 488, 608, 610

Fersa*	Pag.
6003 2RS / C3	130, 137, 139, 140, 144, 147, 152, 174, 178, 180, 388, 393, 401, 407, 488, 608, 610
6004	6, 7, 12, 13, 20, 60, 65, 67, 74, 97, 98, 199, 315, 318, 334, 351, 354, 358, 359, 366, 388, 393, 401, 407, 413, 488, 489, 581, 591, 592, 593, 596, 603, 605, 608, 610
6004 2RS	6, 7, 20, 388, 393, 401, 407, 413, 489, 603, 605
6004 2RS / C3	388, 393, 401, 407, 413, 489
6004 Z	74, 388, 393, 401, 407, 413, 489
6004 ZZ / C3	388, 393, 401, 407, 413, 489
6005	105, 106, 107, 109, 128, 382, 388, 393, 394, 401, 407, 413, 489, 600, 603, 605, 608, 610
6005 2RS	105, 106, 107, 109, 128, 382, 388, 393, 394, 401, 407, 413, 489, 600, 603, 605, 608, 610
6005 2RS / C3	128, 388, 394, 401, 407, 489, 608, 610
6005 ZZ / C3	388, 394, 401, 407, 413, 489
6006	7, 13, 53, 105, 119, 164, 166, 296, 298, 381, 388, 394, 401, 407, 413, 489, 592, 593, 600, 601, 603, 605, 608, 610
6006 2RS	7, 119, 166, 381, 388, 394, 401, 407, 489, 600, 601, 603, 605, 608, 610
6006 2RS / C3	164, 388, 394, 401, 407, 489, 608, 610
6006 RS / C3	164, 388, 394, 401, 407, 489, 608, 610
6006 ZZ / C3	388, 394, 401, 407, 413, 489
6007	12, 13, 18, 19, 22, 53, 55, 58, 59, 62, 63, 65, 79, 87, 88, 89, 90, 91, 92, 93, 98, 108, 110, 197, 203, 207, 208, 293, 294, 296, 298, 299, 301, 303, 305, 307, 310, 312, 313, 314, 316, 317, 321, 324, 326, 328, 330, 332, 341, 342, 343, 349, 350, 355, 359, 366, 367, 369, 388, 395, 401, 407, 408, 413, 489, 490, 491, 581, 589, 591, 592, 593, 596, 603, 605, 608, 610
6007 2RS	22, 388, 395, 401, 407, 408, 413, 490, 603, 605
6007 2RS / C3	388, 395, 401, 408, 413, 490
6007 C3	87, 88, 89, 91, 93, 367, 369, 388, 395, 401, 408, 490, 596, 603, 605
6007 N	13, 53, 55, 58, 62, 63, 65, 197, 203, 296, 298, 299, 301, 303, 305, 307, 310, 312, 313, 316, 321, 324, 326, 328, 330, 332, 341, 342, 343, 388, 395, 401, 408, 490, 491, 581, 591, 593, 603, 605, 608, 610
6008	4, 7, 8, 9, 12, 13, 17, 23, 32, 35, 388, 395, 401, 408, 491, 492, 581, 603, 605
6008 2RS	4, 7, 9, 388, 395, 401, 408, 492, 603, 605
6008 Z	32, 35, 388, 395, 401, 408, 492, 603, 605
6009	6, 8, 9, 11, 19, 34, 63, 107, 108, 203, 228, 328, 330, 334, 336, 344, 345, 346, 347, 382, 388, 396, 401, 408, 492, 585, 591, 593, 600, 603, 605, 608, 610
6009 2RS	6, 8, 9, 388, 396, 401, 408, 492, 603, 605
6009 C3	63, 107, 203, 328, 330, 334, 336, 344, 345, 346, 347, 382, 388, 396, 401, 408, 492, 591, 593, 600, 603, 605, 608, 610
6009 NR	11, 388, 396, 401, 408, 492, 603, 605
6009 ZZ	107, 108, 388, 396, 401, 408, 492
6010	4, 10, 18, 19, 37, 108, 228, 388, 391, 396, 397, 398, 400, 401, 405, 408, 411, 413, 492, 493, 556, 558, 603, 605, 608, 610
6010 2RS	18, 19, 388, 397, 401, 408, 493, 603, 605
6010 C3	108, 388, 397, 401, 408, 493
6010 Z	10, 388, 397, 401, 408, 493, 603, 605

Fersa®	Pag.
6011	5, 7, 9, 34, 38, 60, 87, 89, 90, 91, 92, 93, 97, 199, 229, 231, 232, 233, 315, 318, 355, 356, 363, 363, 366, 367, 369, 388, 397, 401, 408, 493, 585, 591, 593, 595, 596, 603, 605, 608, 610
6011 C3	91, 93, 355, 356, 363, 364, 366, 367, 369, 388, 397, 401, 408, 493, 603, 605, 608, 610
6011 ZZ	7, 9, 388, 397, 401, 408, 493, 603, 605
6013	12, 23, 125, 126, 127, 128, 166, 167, 388, 390, 394, 398, 401, 402, 408, 493, 543, 581, 603, 605
6014	35, 37, 94, 95, 97, 333, 339, 340, 343, 354, 358, 360, 362, 365, 380, 381, 383, 388, 398, 401, 408, 413, 493, 494, 591, 593, 596, 597, 600, 601, 603, 605, 608, 610
6014 2RS	35, 37, 94, 95, 97, 354, 358, 360, 362, 365, 388, 398, 401, 408, 413, 494, 596, 597, 603, 605, 608, 610
6014 2RS / C3	35, 95, 388, 398, 401, 408, 413, 494, 596, 597
6014 C3	333, 339, 340, 343, 381, 383, 388, 389, 401, 408, 494, 591, 593, 600, 603, 605, 608, 610
6015 Z	96, 355, 361, 363, 364, 388, 398, 401, 408, 494, 596, 597, 608, 610
6016 2RS / C3	388, 399, 401, 408, 413, 494
608 2RS / C3	388, 401, 407, 413, 494
6017 NR	229, 388, 399, 401, 408, 494, 585, 608, 610
6200 2RS	129, 131, 135, 138, 139, 141, 142, 169, 225, 240, 388, 393, 401, 407, 494, 583, 584, 587, 603, 605, 608, 610
6200 2RS / C3	129, 131, 135, 138, 139, 141, 142, 169, 225, 388, 393, 401, 407, 494, 603, 605, 608, 610
6201	12, 17, 18, 32, 33, 35, 36, 37, 42, 53, 55, 60, 66, 68, 69, 71, 87, 89, 90, 91, 92, 93, 96, 100, 106, 107, 108, 149, 393, 401, 407, 494, 608, 610
6201 2RS	17, 18, 32, 33, 35, 36, 37, 42, 55, 60, 66, 68, 69, 71, 91, 96, 100, 107, 388, 393, 401, 407, 413, 494
6201 2RS / C3	32, 33, 35, 36, 37, 42, 55, 60, 66, 68, 69, 71, 91, 96, 100, 107, 109, 125, 126, 127, 128, 131, 135, 138, 139, 141, 143, 145, 147, 148, 149, 151, 152, 154, 155, 156, 157, 164, 171, 172, 174, 176, 177, 178, 179, 180, 181, 189, 193, 198, 216, 235, 236, 241, 242, 293, 294, 302, 304, 314, 317, 333, 335, 340, 346, 348, 362, 364, 372, 373, 374, 382, 388, 393, 401, 407, 494, 495, 496, 581, 586, 587, 592, 596, 597, 599, 600, 603, 605, 608, 610, 612
6201 N 2RS / C3	32, 149, 150, 388, 393, 401, 407, 496, 603, 605
6201 RS / C3	60, 198, 314, 317, 388, 393, 401, 407, 496, 592, 603, 605
6201 Z	12, 388, 393, 401, 407, 496, 581, 603, 605
6201 Z / C3	53, 87, 89, 90, 92, 93, 190, 295, 297, 356, 367, 368, 382, 597, 393, 401, 407, 496, 497, 592, 595, 596, 603, 605, 608, 610
6201 ZZ	35, 87, 90, 96, 231, 356, 362, 364, 388, 393, 401, 407, 497, 585, 596, 597, 608, 610
6201 ZZ / C3	106, 108, 110, 143, 149, 154, 175, 176, 178, 181, 337, 388, 393, 401, 407, 413, 494, 592, 600, 603, 605, 608, 610
6202	17, 18, 21, 22, 135, 139, 141, 388, 393, 401, 407, 497, 603, 608, 610
6202 2RS	4, 6, 7, 20, 22, 107, 109, 170, 174, 175, 178, 181, 233, 382, 388, 393, 401, 407, 497, 585, 600, 603, 605, 608, 610
6202 2RS / C3	91, 96, 129, 131, 147, 166, 167, 170, 172, 174, 176, 181, 362, 364, 388, 393, 401, 407, 497, 498, 596, 597, 603, 605, 608, 610
6202 C3	138, 388, 393, 401, 407, 498, 603, 605
6202 Z	12, 18, 388, 393, 401, 407, 498, 581, 585, 596, 603, 605, 608
6202 Z / C3	87, 88, 90, 92, 93, 356, 367, 368, 388, 393, 401, 407, 498, 596, 597, 603, 605, 608, 610

Fersa®	Pag.
6202 ZZ	23, 35, 169, 173, 175, 181, 229, 231, 232, 388, 393, 401, 407, 498, 585, 603, 605, 608, 610
6202 ZZ / C3	129, 131, 388, 393, 401, 407, 498, 603, 605
6203	17, 18, 32, 33, 57, 68, 69, 70, 71, 75, 76, 170, 189, 195, 197, 234, 235, 237, 238, 292, 293, 294, 307, 309, 312, 340, 372, 388, 393, 401, 407, 499, 586, 587, 592, 593, 599, 603, 605, 608, 610
6203 2RS / C3	114, 125, 126, 127, 128, 129, 130, 131, 132, 133, 134, 135, 137, 138, 139, 140, 141, 142, 143, 144, 146, 147, 148, 149, 150, 151, 152, 166, 167, 169, 170, 171, 172, 174, 175, 176, 178, 180, 181, 216, 235, 236, 240, 241, 335, 388, 393, 401, 407, 499, 500, 581, 586, 592, 603, 605, 606, 608, 610
6203 C3	53, 55, 57, 60, 62, 64, 73, 296, 297, 299, 300, 302, 304, 307, 309, 312, 315, 318, 321, 324, 326, 328, 330, 332, 337, 340, 342, 345, 388, 393, 401, 407, 500, 501, 592, 593, 603, 605, 608, 610
6203 Z	6, 23, 388, 393, 401, 407, 501, 603, 605
6203 ZZ	9, 10, 11, 19, 23, 32, 33, 35, 135, 141, 170, 229, 232, 240, 388, 393, 401, 407, 413, 502, 585, 586, 603, 605, 608, 610
6203 ZZ / C3	9, 134, 135, 139, 141, 146, 149, 388, 393, 401, 407, 413, 502
6204	53, 60, 65, 66, 67, 68, 96, 106, 108, 110, 132, 133, 134, 189, 190, 199, 293, 294, 295, 297, 315, 317, 318, 340, 349, 350, 351, 356, 362, 388, 393, 401, 407, 502, 592, 593, 596, 596, 603, 605, 608, 610
6204 2RS	4, 5, 6, 7, 30, 21, 22, 42, 53, 54, 55, 57, 58, 59, 60, 61, 62, 65, 68, 70, 71, 73, 75, 76, 191, 192, 193, 195, 197, 198, 199, 203, 204, 240, 296, 297, 299, 301, 302, 303, 304, 305, 307, 310, 312, 314, 315, 317, 318, 326, 328, 330, 332, 337, 340, 342, 345, 388, 393, 401, 407, 503, 504, 586, 587, 592, 593, 603, 605, 608, 610
6204 2RS / C3	42, 53, 55, 57, 60, 65, 68, 69, 70, 71, 75, 190, 192, 193, 195, 197, 198, 199, 201, 204, 216, 225, 240, 296, 297, 299, 301, 303, 305, 307, 309, 312, 314, 315, 317, 321, 324, 330, 332, 334, 337, 340, 342, 345, 388, 393, 401, 407, 504, 505, 581, 586, 587, 592, 593, 603, 605, 608, 610
6204 C3	126, 128, 388, 393, 401, 407, 505
6204 Z	6, 12, 17, 18, 388, 393, 401, 407, 505, 603, 605
6204 ZZ	9, 12, 388, 393, 401, 407, 413, 505, 581, 603, 605
6204 ZZ / C3	388, 393, 401, 407, 413, 505
6205	13, 19, 21, 60, 66, 93, 96, 105, 106, 107, 109, 153, 154, 164, 199, 232, 233, 314, 315, 318, 351, 362, 364, 388, 394, 401, 407, 505, 506, 581, 585, 592, 596, 597, 603, 605, 608, 610
6205 2RS	6, 7, 20, 21, 22, 32, 34, 35, 36, 37, 60, 61, 68, 69, 70, 71, 72, 73, 87, 89, 90, 91, 92, 93, 94, 97, 98, 189, 198, 199, 240, 293, 294, 314, 315, 317, 318, 334, 335, 336, 340, 345, 346, 348, 354, 355, 356, 357, 359, 360, 365, 366, 367, 388, 394, 401, 407, 506, 507, 592, 593, 596, 596, 597, 603, 605, 608, 610
6205 2RS / C3	87, 89, 90, 92, 93, 240, 354, 365, 367, 368, 388, 394, 401, 407, 507, 586, 587, 596, 597, 603, 605, 608, 610
6205 C3	93, 367, 368, 388, 394, 401, 407, 508, 596, 603, 605, 608, 610
6205 RS	92, 97, 363, 364, 388, 394, 401, 407, 508, 596, 597, 608, 610
6205 RS / C3	105, 106, 388, 394, 401, 407, 508
6205 Z	6, 20, 21, 32, 33, 34, 35, 36, 144, 148, 228, 230, 253, 388, 394, 401, 407, 508, 585, 589, 603, 605, 608, 610
6205 ZZ	12, 170, 253, 388, 394, 401, 407, 508, 581, 589, 603, 608
6205 ZZ / C3	388, 394, 401, 407, 413, 508

Fersa®	Pag.
6206	12, 17, 18, 19, 20, 21, 53, 57, 67, 68, 69, 70, 71, 75, 76, 105, 106, 108, 109, 195, 197, 292, 293, 294, 296, 298, 307, 309, 312, 334, 346, 347, 348, 349, 350, 381, 382, 388, 394, 401, 407, 508, 509, 581, 592, 593, 600, 603, 605, 606, 608, 610
6206 2RS	4, 5, 6, 7, 8, 20, 21, 22, 336, 340, 345, 381, 382, 383, 388, 394, 401, 407, 509, 510, 592, 593, 600, 603, 605, 608, 610
6206 2RS / C3	114, 145, 150, 240, 241, 388, 394, 401, 407, 510, 586, 603, 605, 608, 610
6206 C3	53, 55, 60, 62, 64, 73, 129, 130, 135, 138, 141, 190, 191, 193, 199, 201, 203, 204, 296, 297, 299, 300, 302, 304, 315, 318, 321, 324, 326, 328, 330, 332, 333, 335, 336, 337, 340, 342, 345, 388, 394, 401, 407, 510, 511, 592, 603, 606, 608, 610
6206 NR	145, 146, 147, 148, 388, 394, 401, 497, 511, 603, 608, 610
6206 NR 2RS	145, 146, 388, 394, 401, 407, 511, 603, 605
6206 Z	10, 36, 388, 394, 401, 407, 511, 603, 605, 606, 610
6206 ZZ	12, 170, 388, 394, 401, 407, 511, 581, 603, 605, 606, 608, 610
6206 ZZ / C3	230, 388, 394, 401, 407, 511, 585, 603, 605, 606, 608, 610
6207	13, 23, 35, 36, 37, 108, 109, 229, 232, 233, 388, 395, 401, 408, 511, 581, 585, 603, 605, 606, 608, 610
6207 2RS	6, 7, 8, 21, 22, 388, 395, 401, 408, 512, 603, 605, 606
6207 2RS / C3	388, 395, 401, 408, 413, 512
6207 C3	87, 89, 90, 91, 92, 93, 94, 97, 98, 176, 233, 354, 355, 356, 357, 359, 363, 364, 366, 367, 369, 388, 395, 401, 408, 512, 585, 596, 603, 605, 606, 608, 610
6207 NR	97, 356, 363, 364, 388, 395, 401, 408, 512, 596, 603, 605, 606, 608, 610
6207 NR 2RS	145, 146, 388, 395, 401, 408, 512, 603, 605, 606
6207 Z	21, 388, 395, 401, 408, 512, 603, 605, 606
6207 ZN / C3	151, 388, 395, 401, 408, 512, 608, 610
6207 ZNR	142, 389, 395, 401, 408, 512, 608, 610
6207 ZZ	32, 33, 35, 37, 389, 395, 401, 408, 512, 603, 605, 606
6208	4, 20, 21, 97, 189, 293, 294, 348, 350, 351, 363, 364, 389, 395, 401, 408, 513, 592, 593, 596, 603, 608
6208 2RS	6, 7, 20, 114, 389, 395, 401, 408, 413, 513, 603, 605, 606, 608
6208 2RS / C3	389, 395, 401, 408, 413, 513
6208 N	56, 58, 61, 63, 191, 194, 196, 197, 200, 201, 202, 203, 298, 300, 306, 307, 308, 310, 311, 312, 313, 316, 319, 321, 322, 324, 326, 328, 330, 331, 334, 336, 341, 345, 346, 382, 389, 395, 401, 408, 513, 514, 592, 593, 600, 603, 605, 606, 608, 610
6208 ZZ	10, 12, 13, 35, 114, 389, 395, 401, 408, 514, 581, 603, 605, 606
6209	19, 23, 107, 108, 154, 229, 231, 232, 233, 389, 396, 401, 408, 514, 585, 603, 605, 606, 608, 610
6209 2RS	4, 6, 7, 17, 19, 389, 396, 401, 408, 514, 515, 603, 605, 606
6209 C3	58, 62, 197, 313, 315, 321, 324, 326, 328, 341, 342, 343, 389, 396, 401, 408, 515, 592, 593, 603, 605, 606, 608, 610
6209 NR	154, 389, 396, 401, 408, 515, 603, 605, 606, 608, 610
6209 NR / C3	169, 389, 396, 401, 408, 515, 603, 605, 606, 608, 610
6209 ZZ	105, 106, 107, 108, 389, 396, 401, 408, 515

Fersa®	Pag.
6210	12, 19, 23, 32, 34, 35, 37, 38, 59, 61, 198, 201, 202, 313, 316, 319, 322, 325, 327, 350, 389, 397, 401, 408, 515, 516, 581, 592, 593, 603, 606, 608, 610
6210 2RS	5, 6, 21, 389, 397, 401, 408, 516, 603, 605, 606
6210 Z	8, 389, 397, 401, 408, 516, 603, 605, 606
6210 ZZ	21, 389, 397, 402, 408, 516, 603, 605, 606
6210 ZZ NR	389, 397, 402, 408, 413, 516
6211	12, 22, 87, 88, 89, 90, 91, 92, 96, 97, 354, 356, 358, 361, 363, 365, 366, 368, 389, 397, 402, 408, 416, 581, 596, 603, 605, 606, 608, 610
6211 2RS	7, 389, 397, 402, 408, 516, 603, 605, 606
6211 C3	107, 109, 333, 339, 340, 342, 344, 389, 397, 402, 408, 516, 517, 592, 593, 603, 605, 606, 608, 610
6211 N / C3	53, 54, 192, 301, 303, 332, 333, 338, 341, 343, 389, 397, 402, 408, 517, 592, 603, 605, 606, 608, 610
6211 Z	8, 10, 389, 397, 402, 408, 517, 584, 603, 605, 606, 608, 610
6211 ZNR	4, 10, 18, 225, 238, 239, 253, 389, 397, 402, 408, 517, 584, 586, 589, 603, 605, 606, 608, 610
6212	22, 92, 93, 231, 232, 354, 365, 366, 367, 368, 389, 397, 402, 408, 517, 585, 596, 603, 605, 606, 608, 610
6212 2RS	8, 389, 397, 402, 408, 517, 603, 605, 606
6212 NR	17, 18, 19, 389, 397, 402, 408, 517, 603, 605, 606
6212 ZNR	229, 389, 397, 402, 408, 517, 585, 608, 610
6213 C3	62, 203, 328, 330, 334, 346, 389, 398, 402, 408, 517, 518, 592, 595, 608, 610
6214	228, 230, 389, 398, 402, 408, 518, 585, 608, 610
6215 C3	368, 389, 399, 402, 408, 518, 596, 597, 608, 610
6215 NR / C3	88, 89, 90, 92, 365, 366, 389, 399, 402, 408, 518, 596, 598, 608, 610
6216 C3	347, 389, 399, 402, 408, 518, 592, 595, 608, 610
6218 C3	61, 63, 201, 202, 203, 319, 322, 325, 327, 328, 334, 344, 389, 399, 402, 408, 518, 592, 595, 608, 610
62201 2RS / C3	53, 55, 57, 60, 62, 64, 68, 69, 70, 71, 72, 74, 75, 76, 99, 102, 105, 106, 107, 109, 125, 126, 127, 128, 190, 191, 193, 195, 197, 199, 201, 202, 204, 234, 235, 236, 238, 242, 292, 295, 297, 299, 300, 302, 304, 307, 309, 312, 315, 317, 321, 324, 326, 327, 330, 332, 333, 335, 337, 340, 342, 345, 346, 347, 348, 354, 365, 367, 381, 382, 389, 393, 402, 407, 518, 519, 520, 586, 587, 592, 593, 594, 596, 598, 600, 603, 605, 606, 609, 610
62202 2RS / C3	125, 126, 127, 128, 154, 389, 393, 402, 407, 520, 603, 605, 606, 609, 610
62204 2RS	53, 55, 57, 60, 64, 68, 69, 70, 71, 75, 76, 190, 191, 192, 193, 195, 197, 199, 201, 204, 292, 296, 297, 299, 300, 301, 303, 305, 307, 309, 312, 315, 318, 321, 324, 330, 332, 337, 342, 345, 389, 393, 402, 407, 520, 521, 592, 603, 605, 606, 609, 610
62205 2RS	154, 389, 394, 402, 407, 521, 609, 610
62206 2RS	114, 389, 394, 402, 407, 521, 609, 610
62302 2RS / C3	125, 126, 127, 128, 603, 605, 606, 609, 610
6300 2RS / C3	389, 393, 402, 407, 413, 521
6301 2RS / C3	389, 393, 402, 407, 413, 521
6302	66, 67, 68, 69, 70, 71, 105, 106, 107, 109, 229, 231, 233, 349, 350, 389, 393, 402, 407, 521, 585, 592, 593, 603, 605, 606, 608, 610
6302 2RS	116, 389, 393, 402, 407, 521, 608
6302 2RS / C3	154, 155, 389, 393, 402, 407, 521, 603, 605, 606, 608, 610

Fersa®	Pag.
6302 Z	6, 10, 23, 389, 393, 402, 407, 521, 603, 605, 606
6302 ZZ / C3	389, 393, 402, 407, 413, 521
6303	12, 35, 55, 71, 114, 189, 193, 293, 294, 303, 305, 389, 393, 402, 521, 522, 581, 592, 593, 603, 605, 606, 608, 610
6303 2RS	20, 114, 389, 393, 402, 407, 522, 603, 605, 606, 608
6303 2RS / C3	32, 33, 35, 36, 37, 42, 53, 55, 57, 60, 62, 72, 74, 75, 76, 93, 100, 105, 106, 107, 109, 114, 128, 130, 131, 137, 139, 144, 149, 150, 152, 156, 157, 177, 179, 180, 189, 190, 193, 195, 197, 198, 201, 202, 292, 293, 294, 295, 297, 302, 304, 307, 309, 312, 314, 317, 321, 324, 325, 327, 337, 340, 345, 346, 354, 365, 367, 368, 372, 373, 374, 382, 389, 393, 402, 407, 413, 522, 523, 581, 592, 593, 594, 596, 597, 599, 600, 603, 605, 606, 608, 610
6303 C3	107, 109, 389, 393, 402, 407, 523
6303 RS / C3	9, 60, 314, 317, 321, 324, 348, 389, 393, 402, 407, 523, 524, 592, 593, 603, 605, 606, 608, 610
6303 RSR / C3	198, 201, 389, 393, 402, 407, 524
6303 Z	6, 11, 12, 389, 393, 402, 407, 524, 581, 603, 605, 606
6303 Z / C3	292, 389, 393, 402, 407, 524, 592, 593, 603, 605, 606
6303 ZZ	32, 33, 35, 389, 393, 402, 407, 524, 603, 605, 606
6303 ZZ / C3	64, 75, 204, 330, 332, 337, 340, 342, 344, 389, 393, 402, 407, 524, 592, 593, 603, 605, 606, 608, 610
6304	12, 33, 35, 37, 38, 66, 67, 71, 87, 89, 90, 92, 93, 98, 105, 107, 109, 189, 229, 231, 232, 233, 293, 294, 354, 356, 359, 366, 367, 368, 369, 381, 389, 393, 402, 407, 524, 525, 581, 585, 592, 595, 596, 596, 597, 600, 603, 606, 608, 610
6304 2RS	6, 33, 34, 35, 36, 37, 114, 230, 380, 381, 383, 389, 393, 402, 407, 525, 585, 600, 603, 606, 608, 610
6304 2RS / C3	57, 174, 177, 189, 197, 307, 309, 312, 389, 393, 402, 407, 525, 592, 603, 606
6304 C3	32, 53, 55, 68, 69, 70, 71, 73, 91, 94, 96, 191, 193, 296, 298, 303, 305, 389, 393, 402, 407, 525, 592, 593, 597, 598, 603, 606, 608, 610
6304 ZZ	10, 33, 153, 389, 393, 402, 407, 526, 603, 606, 608, 610
6304 ZZ / C3	389, 393, 402, 407, 413, 526
6305	12, 13, 23, 60, 66, 67, 92, 94, 96, 154, 199, 204, 205, 249, 256, 257, 259, 263, 270, 271, 315, 318, 348, 351, 360, 362, 364, 389, 394, 402, 407, 526, 581, 592, 593, 597, 598, 603, 606, 608, 610
6305 2RS	5, 6, 21, 87, 88, 89, 90, 92, 93, 96, 98, 240, 242, 354, 355, 356, 359, 360, 362, 364, 365, 366, 367, 368, 389, 394, 402, 407, 526, 527, 586, 587, 596, 587, 603, 606, 608, 610
6305 2RS / C3	91, 92, 94, 97, 354, 359, 360, 366, 389, 394, 402, 407, 413, 527, 597, 603, 606, 608, 610
6305 C3	12, 93, 145, 146, 147, 176, 367, 368, 389, 394, 402, 407, 527, 581, 596, 597, 603, 606, 608, 610
6305 ZZ / C3	389, 394, 402, 407, 413, 527
6306	12, 20, 23, 32, 34, 35, 389, 394, 402, 407, 413, 527, 581, 603, 606
6306 2RS	6, 7, 9, 229, 231, 232, 389, 394, 402, 407, 527, 585, 603, 606, 608
6306 2RS / C3	6, 7, 9, 229, 321, 232, 389, 394, 402, 407, 527, 585, 603, 606, 608, 610
6306 C3	171, 172, 173, 176, 181, 389, 394, 402, 407, 528, 603, 606, 608, 610
6306 D25 2RS / C3	389, 394, 402, 407, 413, 528
6306 NR	17, 145, 151, 154, 389, 394, 402, 407, 528, 603, 606, 608, 610

Fersa®	Pag.
6306 NR 2RS / C3	145, 146, 389, 394, 402, 407, 528, 608, 610
6306 ZNR	153, 389, 394, 402, 407, 528, 608, 610
6306 ZNR / C3	145, 389, 394, 402, 407, 528, 608, 610
6306 ZZ	108, 110, 169, 389, 394, 402, 407, 528, 603, 606, 608, 610
6306 ZZ / C3	181, 389, 394, 402, 407, 413, 528
6307	10, 11, 19, 20, 32, 34, 35, 37, 94, 367, 369, 389, 395, 402, 408, 528, 596, 597, 606, 608
6307 2RS	9, 22, 389, 395, 402, 408, 528, 603, 606
6307 2RS / C3	389, 395, 402, 408, 413, 528
6307 C3	33, 34, 389, 395, 402, 408, 529, 603, 606
6307 NR	4, 20, 389, 395, 402, 408, 529, 603, 606, 608, 610
6307 NR 2RS	389, 395, 402, 408, 608, 610
6307 RS	5, 8, 389, 395, 402, 408, 529, 603, 606
6307 Z	169, 389, 395, 402, 408, 529, 603, 606
6307 ZNR	225, 239, 253, 389, 395, 402, 408, 529, 584, 586, 587, 589, 603, 606, 608, 610
6308	20, 22, 34, 38, 228, 231, 389, 395, 402, 408, 529, 585, 603, 606, 608, 610
6308 2RS	4, 20, 389, 395, 402, 408, 529, 603, 606
6308 N	132, 133, 134, 147, 148, 225, 238, 239, 253, 289, 395, 402, 408, 529, 584, 586, 589, 603, 606, 608, 610
6308 NR	132, 133, 134, 147, 148, 238, 239, 253, 389, 395, 402, 408, 529, 586, 589, 603, 606, 608, 610
6308 NR / C3	169, 529
6308 ZNR	225, 253, 389, 395, 402, 408, 529, 584, 589, 603, 608, 610
6308 ZNR / C3	52, 54, 192, 295, 296, 301, 303, 338, 350, 389, 395, 402, 408, 530, 592, 593, 603, 606
6309	4, 20, 34, 37, 389, 396, 402, 408, 530, 603, 606
6309 2RS	4, 5, 6, 7, 8, 20, 389, 396, 402, 408, 530, 603, 606
6309 NR	88, 96, 238, 239, 253, 389, 396, 402, 408, 530, 586, 587, 589, 603, 606, 608, 610
6309 NR / C3	88, 96, 361, 363, 389, 396, 402, 408, 530, 597, 598, 608, 610
6309 Z / C3	65, 349, 389, 396, 402, 408, 530, 592, 595, 608, 610
6309 ZNR / C3	87, 88, 89, 91, 355, 389, 396, 402, 408, 530, 596, 597, 603, 606, 608, 610
6310	5, 20, 228, 231, 232, 381, 389, 397, 402, 408, 530, 531, 585, 600, 603, 606, 608, 610
6310 2RS	4, 230, 389, 397, 402, 408, 531, 585, 603, 606, 608
6310 C3	350, 389, 397, 402, 408, 531, 593, 603, 606, 609, 610
6311	96, 228, 231, 232, 355, 361, 363, 365, 389, 397, 402, 408, 531, 585, 597, 598, 609, 610
6311 C3	5, 8, 20, 350, 389, 397, 402, 408, 531, 593, 595, 603, 606, 609, 610
6311 NR / C3	88, 95, 96, 355, 361, 363, 389, 397, 402, 408, 531, 597, 598, 609, 610
6312 C3	94, 333, 339, 340, 342, 344, 348, 357, 359, 361, 389, 398, 402, 408, 531, 593, 597, 603, 606, 609, 610
6312 NR / C3	88, 89, 389, 398, 402, 408, 531
6313 C3	347, 389, 398, 402, 408, 531, 593, 595, 609, 610
6314	58, 63, 198, 203, 313, 316, 328, 331, 389, 398, 402, 408, 531, 593, 595, 609, 610
6314 C3	61, 63, 72, 200, 202, 203, 319, 322, 325, 326, 328, 331, 333, 334, 389, 398, 402, 408, 532, 593, 603, 606, 609, 610

Fersa®	Pag.
6314 N / C3	58, 105, 108, 313, 316, 333, 339, 389, 398, 402, 408, 532, 603, 606
6314 NR / C3	88, 89, 90, 92, 198, 231, 233, 389, 398, 402, 408, 532, 585, 593, 594, 609, 610
6386 / 6320	107, 109, 378, 381, 390, 398, 405, 411, 532, 600, 601, 603, 606, 607
6403 2RS / C3	53, 55, 57, 60, 62, 64, 66, 68, 69, 190, 191, 193, 195, 197, 198, 199, 202, 204, 234, 235, 236, 238, 241, 295, 297, 299, 300, 302, 304, 307, 309, 312, 314, 315, 317, 325, 327, 330, 332, 340, 342, 344, 354, 390, 393, 402, 407, 532, 533, 586, 587, 592, 593, 594, 595, 597, 598, 603, 606, 609, 610
6403 C3	70, 71, 201, 321, 324, 390, 393, 402, 407, 533, 592, 593, 603, 606
6407 C3	88, 95, 355, 361, 363, 390, 395, 402, 408, 533, 597, 598, 609, 610
6408	228, 229, 231, 232, 390, 396, 402, 408, 533, 585, 603, 606, 609, 610
6408 NR / C3	88, 91, 390, 396, 402, 408, 533
6409	231, 232, 390, 396, 402, 408, 533, 585, 609, 610
6409 C3	95, 355, 361, 363, 390, 396, 402, 408, 534, 597, 598, 609, 610
6409 NR / C3	95, 96, 355, 361, 363, 390, 396, 402, 408, 534, 597, 598, 609, 610
641 / 632	226, 390, 398, 405, 411, 534, 584, 602, 606
6411 NR / C3	87, 88, 91, 95, 96, 355, 360, 361, 363, 534, 597, 589, 609, 610
6413 NR / C3	87, 88, 89, 91, 534
64450 / 64700	102, 370, 390, 399, 405, 412, 534, 598, 603, 606
6461A / 6420	102, 370, 390, 399, 405, 412, 534, 598, 603, 606
65237 / 65500	45, 46, 222, 223, 226, 245, 250, 259, 260, 261, 390, 398, 405, 411, 534, 582, 583, 584, 587, 588, 590, 603, 606
66225 / 66462	222, 390, 397, 405, 411, 534, 583, 603, 606
663 / 652	50, 390, 399, 405, 411, 534
663 / 653	102, 105, 106, 107, 109, 378, 381, 382, 383, 390, 399, 405, 411, 534, 535, 600, 603, 606
665 / 652	50, 390, 399, 405, 411, 535
665 / 653	50, 390, 399, 405, 411, 535
681 A / 672	50, 226, 390, 399, 405, 411, 535, 584, 603, 606
683 / 672	102, 105, 106, 107, 109, 378, 381, 382, 383, 390, 399, 405, 412, 535, 600, 603, 606
68450 / 68712	50, 221, 390, 399, 405, 412, 535, 583, 603, 606
68462 / 68712	238, 390, 399, 405, 412, 535, 587, 603, 606
687 / 672	102, 105, 106, 107, 109, 380, 381, 383, 390, 399, 405, 412, 535, 600, 603, 606, 608, 610
7210 B	390, 397, 402, 408, 413, 535
72188 C / 72487	217, 222, 223, 244, 268, 390, 396, 405, 410, 535, 582, 583, 587, 588, 595, 603, 606
72200 C / 72487	47, 217, 219, 221, 222, 223, 227, 244, 245, 254, 263, 264, 265, 266, 267, 268, 269, 271, 272, 273, 274, 275, 285, 390, 397, 405, 410, 535, 536, 582, 583, 584, 587, 588, 589, 595, 603, 606
72212 C / 72487	44, 46, 50, 104, 219, 221, 227, 246, 247, 251, 257, 260, 390, 397, 405, 410, 536, 583, 584, 588, 590, 591, 603, 606
72218 C / 72487	269, 390, 397, 405, 411, 536, 595, 596, 603, 607
749 / 742	226, 390, 399, 405, 411, 536, 584, 603, 607
760 / 752	226, 390, 399, 405, 411, 536, 584, 603, 607
78215 C / 78551	50, 219, 390, 397, 405, 410, 536, 583, 603, 607
9278 / 9220	43, 50, 83, 84, 103, 104, 223, 370, 390, 398, 405, 411, 536, 582, 583, 598, 603, 607
9285 / 9220	102, 105, 106, 109, 390, 399, 405, 411, 536

Fersa®	Pag.
A 6075 / A 6157	390, 393, 405, 409, 413, 536
F 15029	130, 137, 138, 139, 390, 394, 400, 406, 412, 536
F 15036	131, 142, 171, 390, 395, 400, 406, 412, 537, 603, 605
F 15041	119, 160, 161, 162, 164, 166, 390, 394, 406, 412, 537, 603, 605
F 15043	157, 390, 394, 406, 412, 537, 603, 606
F 15044	390, 395, 406, 412, 413, 537
F 15046	86, 87, 88, 89, 91, 92, 93, 94, 97, 354, 358, 360, 365, 367, 368, 390, 398, 406, 412, 537, 597, 603, 605, 609
F 15047	48, 49, 61, 63, 71, 73, 77, 78, 105, 108, 200, 202, 203, 258, 268, 318, 321, 324, 326, 328, 330, 334, 338, 344, 345, 347, 358, 380, 381, 382, 390, 397, 406, 412, 537, 538, 590, 591, 595, 597, 600, 603, 605, 609
F 15048	95, 97, 358, 359, 362, 390, 399, 406, 412, 538, 597, 598, 603, 605
F 15051 C	64, 72, 73, 74, 77, 78, 80, 201, 204, 210, 211, 266, 267, 268, 277, 278, 284, 285, 288, 289, 290, 291, 320, 323, 329, 331, 335, 337, 346, 347, 350, 390, 398, 406, 412, 538, 539, 592, 594, 595, 603, 605
F 15058	390, 398, 406, 412, 413, 539
F 15067	390, 394, 406, 412, 413, 539, 609, 610
F 15071	380, 390, 399, 406, 412, 539, 600, 601, 609, 610
F 15076	348, 390, 399, 406, 412, 539, 595, 596, 609
F 15082	79, 81, 207, 210, 211, 263, 264, 265, 266, 267, 269, 270, 273, 277, 278, 280, 282, 283, 284, 285, 287, 288, 289, 290, 291, 390, 398, 406, 412, 539, 540, 594, 595, 603, 605
F 15083	54, 56, 59, 62, 64, 81, 277, 278, 280, 281, 282, 283, 284, 285, 287, 288, 289, 290, 291, 298, 300, 302, 304, 306, 309, 311, 314, 316, 317, 320, 323, 325, 327, 329, 331, 343, 390, 398, 406, 412, 540, 541, 594, 595, 603, 605, 609
F 15097	367, 390, 398, 403, 409, 413, 541, 598,
F 15116	380, 390, 398, 406, 412, 541, 601, 609, 610
F 15128	147, 390, 394, 406, 412, 541, 603, 607
F 15139	390, 397, 403, 409, 413, 541
F 15140	390, 397, 403, 409, 413, 541
F 15141	32, 34, 36, 37, 390, 397, 403, 409, 413, 541, 603, 605
F 15151	163, 390, 394, 406, 412, 413, 541
F 15156	99, 212, 383, 390, 399, 406, 412, 541, 601, 603, 606
F 15158	81, 264, 274, 280, 281, 283, 287, 288, 289, 390, 398, 406, 412, 541, 595, 603, 605
F 15159	77, 78, 80, 81, 207, 210, 211, 263, 266, 267, 268, 274, 277, 278, 280, 281, 282, 284, 285, 287, 288, 289, 290, 291, 336, 339, 343, 390, 398, 406, 412, 542, 543, 595, 603, 605
F 15165	23, 36, 390, 399, 406, 412, 413, 543, 603, 605
F 15173	167, 390, 395, 406, 412, 543
F 15175	166, 390, 394, 406, 412, 543, 603, 607
F 15183	302, 316, 323, 343, 390, 398, 406, 412, 413, 543, 603, 605
F 16013	125, 126, 127, 128, 166, 167, 390, 394, 402, 408, 543, 603, 605
F 16019	120, 144, 165, 171, 172, 390, 394, 402, 408, 543, 603, 605
F 16020	147, 152, 390, 394, 402, 408, 543
F 16021	390, 395, 402, 408, 413, 543

Fersa®	Pag.
F 16023	179, 390, 395, 402, 408, 543, 603, 605
F 16026	119, 128, 164, 290, 395, 402, 408, 543, 603, 605
F 16028	179, 390, 395, 402, 408, 543, 603, 605
F 16029	119, 164, 390, 395, 400, 402, 408, 413, 544, 609, 610
F 16030	390, 395, 402, 408, 413, 544, 609, 610
F 16032	390, 395, 402, 408, 413, 544, 609, 610
F 16034	161, 162, 163, 390, 395, 402, 408, 544
F 16035	390, 395, 402, 408, 413, 544, 609, 610
F 16036	130, 137, 138, 139, 173, 177, 179, 180, 181, 390, 395, 402, 408, 413, 544, 609, 610
F 16037	149, 390, 395, 402, 409, 544, 609, 610
F 16038	115, 178, 390, 395, 402, 409, 544
F 16039	168, 172, 173, 175, 178, 179, 182, 390, 395, 402, 409, 544, 603, 605
F 16040	115, 168, 171, 175, 177, 390, 395, 402, 409, 544, 603, 606
F 16044	390, 395, 402, 408, 413, 544
F 16048	390, 396, 402, 409, 413, 544, 609, 610
F 16051	390, 396, 402, 409, 413, 544, 609, 610
F 16052	153, 390, 396, 402, 409, 413, 544, 609, 611
F 16054	115, 177, 178, 390, 396, 402, 409, 544
F 16055	129, 131, 158, 390, 396, 402, 409, 544
F 16057	121, 164, 390, 396, 402, 408, 544, 545
F 16058	160, 163, 390, 396, 402, 409, 545
F 16059	116, 390, 396, 402, 409, 545
F 16065	175, 177, 390, 394, 403, 408, 545, 603, 606
F 16078	170, 390, 396, 403, 409, 545, 603, 607
F 16081	160, 161, 360, 396, 403, 409, 545, 603, 607
F 16083	147, 149, 152, 390, 394, 403, 408, 545, 603, 606
F 16088	137, 155, 390, 396, 403, 409, 545
F 16097	390, 395, 403, 408, 413, 545
F 16098	390, 394, 403, 408, 413, 545
F 16099	390, 395, 403, 408, 413, 545
F 16100	390, 395, 403, 408, 413, 545
F 16101	390, 395, 403, 408, 413, 545
F 16102	390, 395, 403, 409, 413, 545
F 16103	390, 395, 403, 409, 413, 545
F 16104	390, 394, 403, 408, 413, 545
F 16110	180, 390, 395, 403, 409, 545
F 16194	118, 130, 142, 143, 390, 396, 403, 409, 545
F 16195	116, 117, 118, 390, 396, 403, 409, 545
F 16196	160, 161, 390, 396, 403, 409, 545, 603, 607
F 16197	122, 390, 396, 403, 409, 545, 603, 607
F 16198	122, 390, 395, 403, 409, 545, 603, 607
F 16199	162, 390, 396, 403, 409, 545, 603, 607
F 18018	390, 394, 403, 409, 413, 545
F 18021	157, 390, 394, 403, 409, 545, 603, 605
F 18024	115, 131, 137, 168, 171, 175, 179, 390, 394, 403, 409, 546, 604, 605
F 18031	390, 398, 403, 409, 413, 546
F 18039	391, 395, 403, 409, 413, 546

Fersa®	Pag.
F 18040	391, 398, 403, 409, 413, 546
F 18041	391, 397, 403, 409, 413, 546
F 19001	95, 357, 359, 362, 391, 396, 403, 409, 546, 597, 598, 604, 606
F 19002	391, 396, 403, 409, 413, 546
F 19008	345, 391, 399, 403, 409, 413, 546, 604, 605
F 19009	391, 398, 403, 409, 413, 546, 604, 605
F 19010	212, 258, 358, 380, 381, 382, 391, 398, 403, 409, 546, 590, 597, 598, 601, 604, 606
F 19011	52, 54, 56, 58, 61, 63, 66, 69, 70, 72, 80, 189, 191, 192, 194, 196, 197, 200, 202, 203, 295, 296, 298, 300, 301, 303, 305, 308, 310, 313, 316, 319, 322, 324, 326, 328, 330, 336, 338, 341, 344, 391, 397, 403, 409, 546, 547, 595, 596, 609
F 19012	391, 395, 403, 409, 413, 547, 604, 605
F 19013	77, 78, 391, 396, 403, 409, 547
F 19015	208, 275, 391, 396, 403, 409, 547, 594, 595, 604, 606
F 19016	391, 398, 403, 409, 413, 547
F 19019	58, 63, 198, 200, 203, 313, 316, 319, 322, 328, 331, 391, 394, 403, 409, 547, 592, 595, 604, 605
F 19020	391, 395, 403, 413, 547
F 19029	391, 394, 403, 409, 413, 547
F 19033	83, 84, 102, 391, 395, 403, 409, 547
F 19034	49, 50, 222, 223, 250, 257, 259, 361, 391, 395, 403, 409, 548, 583, 588, 590, 591, 604, 607
F 19039	212, 258, 358, 380, 381, 382, 391, 399, 403, 409, 548, 590, 597, 598, 601, 604, 606
F 19042	391, 398, 403, 409, 413, 548, 604, 606
F 19043	80, 391, 395, 403, 409, 548
F 19044	80, 391, 396, 403, 409, 548
F 19046	56, 61, 63, 191, 194, 196, 200, 202, 203, 298, 300, 306, 308, 311, 319, 322, 325, 326, 328, 331, 341, 391, 397, 403, 409, 548, 595, 596, 609, 610
F 19047	55, 61, 63, 194, 195, 200, 202, 203, 305, 308, 310, 319, 322, 324, 326, 328, 330, 341, 391, 398, 403, 409, 548, 549, 595, 596, 609, 610
F 19048	391, 395, 403, 409, 413, 549
F 19075	391, 394, 403, 409, 413, 549
F 19076	95, 357, 359, 362, 391, 395, 403, 409, 549, 597, 598, 604
F 200001 A	378, 380, 383, 391, 398, 403, 409, 549, 600, 601, 604, 605
F 200002 A	381, 383, 391, 399, 403, 409, 549, 600, 601, 604, 605
F 200003	380, 383, 391, 397, 403, 409, 549
F 200004	48, 391, 399, 403, 409, 549
F 300006	258, 391, 396, 403, 409, 549, 590, 609, 610
H 715334 / H 715311	43, 44, 46, 49, 50, 226, 246, 248, 249, 250, 257, 259, 261, 391, 398, 405, 411, 459, 582, 583, 584, 588, 590, 591, 604, 607
H 715343 / H 715311	43, 45, 46, 49, 222, 223, 245, 246, 249, 250, 257, 259, 261, 391, 398, 405, 411, 549, 550, 582, 583, 586, 587, 588, 590, 591, 604, 607
H 715345 / H 715311	81, 198, 210, 226, 287, 290, 314, 317, 391, 398, 405, 411, 550, 584, 591, 592, 595, 604, 607
H 913842 / H 913810	102, 105, 106, 107, 109, 357, 365, 368, 380, 381, 383, 391, 398, 405, 411, 550, 597, 598, 600, 601, 604, 607
H 914841 / H 914811	260, 275, 391, 398, 405, 411, 550, 591, 595, 596, 604, 607
HM 212044 / HM 212011	50, 187, 221, 226, 391, 398, 405, 411, 550, 583, 584, 604, 607

Fersa*	Pag.
HM 212047 / HM 212011	32, 43, 44, 46, 49, 50, 103, 104, 188, 220, 221, 222, 224, 227, 235, 238, 245, 246, 247, 249, 251, 258, 259, 260, 261, 262, 370, 371, 378, 391, 398, 405, 411, 550, 551, 582, 583, 584, 587, 588, 590, 591, 598, 600, 601, 604, 607
HM 212049 / HM 212011	43, 44, 45, 46, 47, 49, 50, 51, 79, 83, 84, 99, 100, 102, 103, 104, 186, 187, 188, 205, 206, 207, 208, 209, 210, 212, 217, 218, 219, 220, 221, 222, 223, 224, 234, 236, 245, 249, 248, 249, 250, 251, 256, 257, 258, 259, 270, 272, 273, 274, 275, 276, 286, 290, 370, 371, 373, 374, 375, 378, 379, 391, 398, 405, 411, 551, 552, 553, 582, 583, 587, 588, 590, 591, 595, 596, 598, 599, 601, 604, 607
HM 218248 / HM 218210	19, 26, 33, 34, 35, 36, 37, 38, 85, 86, 95, 212, 352, 353, 354, 357, 358, 360, 362, 365, 369, 378, 382, 391, 399, 405, 411, 553, 554, 597, 598, 600, 601, 604, 607
HM 220149 / HM 220110	382, 391, 399, 405, 412, 554, 601, 607
HM 516449 / HM 516410	391, 399, 405, 411, 554, 584, 604, 607
HM 518445 / HM 518410	212, 391, 399, 405, 411, 554, 598, 604, 607
HM 803145 / HM 803110	239, 240, 242, 391, 396, 405, 410, 554, 586, 587, 607
HM 803146 / HM 803110	13, 133, 134, 156, 157, 391, 396, 405, 410, 554, 581, 604, 607, 609, 610
HM 803149 / HM 803110	243, 391, 396, 405, 410, 554, 587, 588, 604, 607
HM 804843 / HM 804810	241, 391, 396, 405, 410, 554, 587, 604, 607
HM 804846 / HM 804810	103, 235, 238, 248, 249, 260, 391, 396, 405, 410, 554, 583, 587, 588, 591, 604, 607
HM 807040 / HM 807010	226, 230, 239, 240, 241, 243, 244, 253, 376, 377, 391, 396, 405, 410, 554, 584, 586, 587, 589, 599, 604, 607, 609, 610
HM 807046 / HM 807010	59, 99, 101, 133, 134, 148, 226, 228, 230, 238, 239, 240, 241, 242, 252, 253, 314, 316, 351, 372, 376, 377, 391, 397, 405, 410, 555, 583, 584, 586, 587, 589, 595, 599, 604, 607, 609, 610
HM 807046 / HM 807011	243, 391, 397, 405, 410, 555, 587, 604, 607
HM 807049 / HM 807010	369, 391, 397, 405, 410, 555, 595, 596, 604, 607
HM 813841 / HM 813810	275, 391, 398, 405, 411, 555, 595, 596, 604, 607
HM 813842 / HM 813810	239, 241, 391, 398, 405, 411, 555, 587, 607
HM 813843 / HM 813810	50, 83, 103, 104, 223, 246, 391, 398, 405, 411, 555, 583, 588, 604, 607
HM 813849 / HM 813810	391, 398, 405, 411, 555
HM 88542 / HM 88510	133, 134, 142, 218, 230, 243, 391, 394, 405, 410, 555, 582, 586, 588, 604, 607, 609, 610
HM 88649 / HM 88610	116, 132, 140, 146, 391, 394, 405, 410, 556, 609, 610
HM 88649 / HM 88610	116, 132, 140, 146, 391, 394, 405, 410, 556, 609, 610
HM 89443 / HM 89411	243, 391, 394, 405, 410, 556, 588, 604, 607
HM 89449 / HM 89410	13, 149, 159, 391, 395, 405, 410, 556, 581, 609, 610
HM 903249 / HM 903210	43, 187, 217, 219, 220, 254, 391, 396, 405, 410, 413, 556, 582, 583, 586, 588, 589, 604, 607
HM 905843 / HM 905810	391, 396, 405, 410, 556
HM 911245 / HM 911210	106, 107, 109, 380, 381, 383, 391, 398, 405, 411, 556, 600, 601, 607
JD 6549 / JD 6510	357, 391, 398, 405, 411, 556, 597, 598, 604, 607
JF 10049 / JF 10010	357, 391, 399, 405, 412, 556, 598, 604, 607
JF 4049 / JF 4010	357, 391, 395, 405, 410, 556, 597, 598, 604, 607

Fersa*	Pag.
JF 4549 / JF 4510	102, 391, 396, 405, 410, 556
JF 5049 / JF 5010	357, 391, 397, 405, 410, 556, 597, 598, 604, 607
JF 6049 / JF 6010	391, 398, 405, 411, 413, 556
JH 211749 / JH 211710	45, 46, 222, 223, 249, 250, 259, 260, 261, 391, 398, 405, 411, 556, 582, 583, 588, 590, 591, 604, 607
JHM 522649 / JHM 522610	95, 97, 357, 359, 362, 391, 399, 405, 412, 557, 597, 598, 607
JHM 720249 / JHM 720210	370, 391, 399, 405, 412, 557, 598, 604, 607
JL 26749 F / JL 26710	117, 118, 391, 394, 405, 410, 557
JL 69349 / JL 69310	121, 122, 124, 132, 135, 138, 144, 148, 152, 391, 395, 405, 410, 557, 609, 610
JL 69349 X / JL 69310	391, 395, 405, 410, 557
JL 819349 / JL 819310	391, 399, 405, 411, 413, 557
JLM 104946 / JLM 104911 A	243, 391, 397, 405, 410, 557, 588, 604, 607
JLM 104948 / JLM 104910	391, 397, 405, 410, 413, 557
JLM 506849 A / JLM 506811	391, 397, 405, 410, 413, 557
JLM 508748 / LM 508710	90, 365, 368, 391, 397, 405, 411, 557, 598, 609, 610
JLM 710949 / JLM 710910	44, 46, 246, 391, 398, 405, 411, 557, 583, 588, 604, 607
JLM 710949 C / JLM 710910	247, 391, 398, 405, 411, 557, 588, 604, 607
JLM 714149 / JLM 714110	45, 46, 222, 223, 248, 250, 259, 260, 261, 270, 271, 391, 399, 405, 411, 557, 582, 583, 588, 590, 591, 594, 595, 604, 607
JM 205149 / JM 205110	391, 397, 405, 410, 413, 558
JM 207049 / JM 207010	44, 204, 221, 224, 270, 391, 397, 405, 410, 558, 583, 595, 596, 604, 607
JM 207049 A / JM 207010	43, 186, 187, 205, 219, 247, 248, 251, 271, 391, 397, 405, 410, 558, 583, 588, 595, 596, 604, 607
JM 511946 / JM 511910	44, 46, 246, 391, 398, 405, 411, 558, 583, 588, 604, 607
JM 714249 / JM 714210	225, 240, 391, 399, 405, 411, 558, 584, 587, 588, 607
JM 716649 / JM 716610	44, 46, 99, 100, 103, 218, 234, 235, 236, 237, 240, 241, 245, 246, 247, 248, 251, 257, 260, 365, 368, 373, 374, 377, 391, 399, 405, 411, 558, 559, 582, 583, 588, 589, 590, 591, 598, 599, 604, 607, 610
JM 720249 / JM 720210	85, 86, 95, 352, 353, 359, 362, 392, 399, 405, 412, 559, 598, 604, 607
JP 12049 / JP 12010	234, 235, 236, 237, 240, 241, 392, 399, 405, 412, 559, 588, 609, 610
JP 12049 A / JP 12010	392, 399, 405, 412, 413, 559
JW 7049 / JW 7010	392, 398, 405, 411, 413, 559
KA 019	131, 142, 171, 400, 559, 604, 607
KA 021	131, 137, 139, 177, 179, 400, 559, 604, 607
KA 038	146, 149, 400, 559, 604, 607
KA 040	146, 400, 559, 604, 607
KA 069	140, 143, 174, 175, 178, 180, 400, 559, 604, 607
KA 075	131, 143, 171, 400, 560, 604, 607
KA 273	157, 400, 560, 604, 607
KF 145	119, 164, 400, 560, 604, 606, 609, 611
KV 164	114, 125, 126, 127, 128, 400, 560, 604, 607
N 307 FM	392, 395, 403, 409, 413, 560, 572
L 44649 / L 44610	14, 15, 16, 116, 121, 129, 130, 141, 146, 160, 171, 392, 394, 400, 405, 410, 560, 604, 607

Fersa®	Pag.
L 45449 / L 45410	115, 120, 124, 131, 138, 140, 142, 143, 144, 146, 147, 149, 152, 153, 162, 168, 171, 172, 173, 174, 175, 176, 177, 178, 179, 180, 181, 182, 392, 394, 400, 405, 410, 560, 561, 604, 605, 609, 610
L 68149 / L 68110	135, 392, 395, 405, 410, 561
L 68149 / L 68111	116, 117, 121, 130, 140, 165, 392, 395, 405, 410, 561
LM 102949 / LM 102910	135, 136, 139, 243, 392, 396, 405, 410, 561, 588, 604, 607
LM 104949 / LM 104910	25, 43, 44, 45, 46, 222, 223, 246, 249, 250, 259, 260, 261, 392, 397, 405, 410, 562, 583, 589, 591, 604, 607
LM 104949 / LM 104911	25, 121, 122, 123, 124, 132, 135, 136, 137, 139, 140, 145, 148, 150, 151, 152, 212, 243, 254, 392, 397, 405, 410, 562, 588, 589, 598, 604, 607
LM 104949 / LM 104912	25, 392, 397, 405, 410, 562, 604, 607
LM 11749 / LM 11710	120, 121, 130, 131, 137, 139, 140, 143, 144, 146, 147, 149, 152, 153, 160, 168, 171, 172, 173, 174, 175, 176, 178, 179, 180, 181, 182, 392, 393, 400, 405, 409, 562, 563, 607, 610
LM 11949 / LM 11910	5, 8, 9, 10, 11, 23, 115, 116, 117, 118, 124, 129, 130, 132, 133, 138, 139, 140, 141, 144, 145, 146, 150, 154, 161, 163, 172, 176, 177, 392, 393, 400, 405, 409, 563, 564, 604, 607
LM 12748 / LM 12710	150, 392, 393, 406, 409, 564
LM 12749 / LM 12710	116, 117, 118, 130, 132, 135, 138, 140, 142, 143, 392, 393, 406, 409, 564
LM 12749 / LM 12711	121, 122, 124, 392, 393, 406, 409, 565
LM 29749 / LM 29710	131, 142, 162, 171, 177, 178, 179, 180, 392, 395, 406, 410, 565, 607, 609, 610
LM 29749 / LM 29711	146, 392, 395, 406, 410, 565, 604, 607
LM 300849 / LM 300811	130, 131, 143, 145, 160, 161, 162, 163, 173, 174, 175, 176, 177, 178, 179, 180, 392, 396, 406, 410, 565, 604, 607, 609, 610
LM 48548 / LM 48510	5, 8, 9, 10, 18, 19, 20, 23, 27, 28, 30, 31, 33, 116, 122, 123, 132, 133, 138, 139, 140, 142, 144, 145, 148, 153, 159, 160, 163, 170, 392, 394, 406, 410, 566, 599, 604, 607, 609, 610
LM 501349 / LM 501310	5, 9, 20, 22, 23, 24, 36, 116, 121, 122, 123, 124, 133, 134, 144, 145, 150, 151, 157, 158, 225, 240, 243, 244, 252, 254, 392, 396, 400, 406, 410, 567, 583, 584, 586, 588, 589, 604, 607, 609, 610
LM 501349 / LM 501314	13, 17, 27, 132, 133, 142, 146, 392, 396, 406, 410, 567, 581, 604, 607, 609, 610
LM 501349 / LM 501510	18, 568
LM 503349 A / LM 503310	392, 396, 406, 410, 568, 604, 607
LM 506849 / LM 506810	122, 123, 392, 397, 406, 410, 568
LM 603049 / LM 603011	8, 9, 10, 11, 18, 19, 25, 33, 132, 133, 134, 155, 160, 161, 162, 163, 222, 392, 396, 406, 410, 568, 583
LM 603049 / LM 603012	116, 140, 151, 392, 396, 406, 410, 568, 609, 610
LM 67048 / LM 67010	4, 7, 24, 25, 27, 30, 116, 117, 132, 140, 142, 143, 145, 146, 150, 151, 160, 172, 176, 177, 392, 394, 406, 410, 568, 569, 604, 607
LM 78349 / LM 78310 A	129, 130, 141, 145, 171, 392, 395, 406, 410, 569
LM 806649 / LM 806610	156, 157, 392, 397, 406, 410, 569, 604, 607, 609, 610
M 12649 / M 12610	19, 20, 21, 22, 23, 25, 122, 124, 133, 144, 145, 148, 151, 153, 159, 160, 170, 392, 393, 406, 409, 569, 599, 604, 607, 609, 610
M 802048 / M 802011	9, 13, 17, 18, 23, 24, 25, 36, 100, 101, 132, 133, 140, 144, 147, 148, 151, 234, 235, 236, 237, 238, 239, 243, 248, 250, 252, 253, 254, 256, 372, 373, 375, 376, 392, 396, 406, 410, 570, 571, 581, 586, 588, 589, 590, 599, 607, 609, 611

Fersa®	Pag.
M 804049 / M 804010	186, 187, 205, 206, 207, 217, 219, 244, 248, 249, 250, 254, 256, 263, 264, 265, 266, 268, 269, 270, 271, 272, 274, 283, 392, 396, 406, 410, 571, 582, 583, 588, 589, 590, 595, 604, 607
M 84548 / M 84510	146, 149, 392, 394, 406, 410, 571, 609, 610
M 86647 / M 86610	146, 392, 394, 406, 410, 571, 609, 611
M 86649 / M 86610	151, 180, 392, 394, 406, 410, 571, 609, 611
M 88043 / M 88010	157, 392, 394, 406, 410, 571, 604, 607
M 88048 / M 88010	25, 132, 133, 140, 144, 146, 147, 148, 149, 392, 394, 406, 410, 571, 572, 604, 607, 609, 611
N 207 / C3	176, 392, 395, 403, 409, 572, 604, 607
N 307 FM	392, 395, 403, 409, 413, 560, 572
N 309 FM	348, 392, 396, 403, 409, 572, 595, 596, 604, 607
NJ 205 / C3	392, 394, 403, 409, 572, 604, 607
NJ 206	114, 392, 394, 403, 409, 572, 604, 607
NJ 2206 FM	292, 392, 394, 403, 409, 572, 594, 595, 604, 607
NJ 2211 FM	52, 54, 56, 190, 192, 194, 196, 295, 296, 301, 303, 305, 308, 310, 338, 350, 392, 397, 403, 409, 572, 593, 595, 604, 607
NJ 2309 F / C3	380, 381, 383, 392, 396, 403, 409, 572, 600, 601
NJ 304 FM	75, 292, 349, 392, 393, 403, 409, 572, 594, 595, 604, 607
NJ 304 FMN	75, 349, 392, 393, 403, 409, 572, 594, 595, 604, 607
NJ 305 C3	60, 67, 70, 71, 199, 315, 318, 340, 347, 392, 394, 403, 409, 572, 595, 596, 609, 611
NJ 305 FM / C3	60, 66, 67, 68, 69, 70, 71, 199, 315, 318, 334, 336, 340, 346, 347, 348, 392, 394, 403, 409, 573, 594, 595, 604, 607, 609, 611
NJ 307 F	229, 392, 395, 403, 409, 573, 609
NJ 309 F	4, 37, 392, 396, 403, 409, 413, 573, 581, 604, 607
NJ 309 C3	12, 392, 396, 403, 409, 573
NJ 309 FM	4, 37, 392, 396, 403, 409, 413, 573, 604, 607
NJ 309 FM / C3	4, 37, 392, 396, 403, 409, 573, 604, 607
NU 1011 FM	392, 397, 403, 409, 413, 573
NU 206 FM	382, 392, 394, 403, 409, 573, 600, 601, 604, 607
NU 208 FM	74, 75, 292, 392, 395, 403, 409, 573, 594, 595, 604, 607
NU 209 FMN	52, 58, 65, 66, 67, 68, 69, 70, 295, 296, 313, 316, 319, 322, 336, 338, 339, 348, 350, 392, 396, 403, 409, 413, 573, 574, 591, 593, 595, 604, 607
NU 209 FMN / C3	392, 396, 403, 409, 413, 574
NU 2205	166, 392, 394, 403, 409, 574, 609, 611
NU 303 FM	60, 65, 67, 68, 69, 70, 71, 73, 199, 315, 318, 333, 335, 340, 346, 347, 348, 392, 393, 403, 409, 574, 592, 595, 596, 604, 607, 609, 611
NU 303 FM / C3	346, 392, 393, 403, 409, 574, 592, 596
NU 303 FMN	73, 392, 393, 403, 409, 574
NU 310 FM	32, 33, 34, 392, 397, 403, 409, 413, 574, 604, 607
NU 310 FM / C3	32, 33, 34, 392, 397, 403, 409, 574, 604, 607
NUP 206 FM	60, 199, 315, 318, 392, 394, 403, 409, 574, 594, 596, 604, 607
NUP 212 FM	350, 392, 398, 403, 409, 574, 596, 609, 611
NUP 2205	114, 392, 394, 403, 409, 574, 604, 607
NUP 2212 F	55, 62, 107, 109, 191, 193, 195, 199, 203, 298, 299, 305, 307, 310, 318, 321, 328, 330, 381, 392, 398, 403, 409, 574, 575, 596, 600, 601, 604, 607

Fersa*	Pag.
NUP 2212 FMN	55, 62, 191, 193, 195, 199, 203, 298, 299, 305, 307, 320, 318, 321, 328, 330, 392, 398, 403, 409, 575, 596, 604, 607
NUP 304 FM	73, 392, 393, 403, 409, 575
NUP 308 FM	229, 392, 395, 403, 409, 575
NUP 309 C3	12, 392, 396, 403, 409, 575
NUP 309 FM	37, 105, 106, 107, 109, 392, 396, 403, 409, 413, 575, 581, 604, 607
NUP 309 FM / C3	105, 106, 107, 109, 392, 396, 403, 409, 575, 581, 604, 607
NUP 310 FM / C3	392, 397, 403, 409, 413, 575
NUP 310 FMN / C3	56, 63, 191, 194, 196, 199, 200, 203, 298, 300, 305, 308, 311, 318, 319, 321, 322, 328, 331, 392, 397, 403, 409, 575, 596, 604, 607
NUP 311 FM	61, 63, 200, 202, 350, 392, 397, 403, 409, 575, 596, 609, 611
NUP 311 FM / C3	338, 392, 397, 403, 409, 575, 592, 596, 604, 607, 609, 611
NUP 311 FMNR / C3	61, 63, 200, 202, 203, 319, 322, 324, 326, 328, 331, 334, 341, 344, 346, 392, 397, 403, 409, 575, 576, 596, 609, 611
NUP 314 FM	58, 198, 316, 392, 398, 403, 409, 576, 596, 609, 611
NUP 314 FM / C3	58, 73, 74, 198, 200, 313, 316, 319, 322, 333, 334, 338, 392, 398, 403, 409, 576, 591, 592, 596, 604, 607
NUP 314 FMN / C3	105, 108, 392, 398, 403, 409, 576
NUP 314 FMNR	230, 392, 398, 403, 409, 576, 586, 609, 611
NUP 314 FMNR / C3	48, 49, 58, 61, 63, 73, 78, 197, 200, 202, 203, 233, 268, 313, 316, 319, 322, 324, 325, 326, 327, 328, 330, 333, 392, 398, 403, 409, 576, 577, 586, 594, 596, 604, 607, 609, 611
QJ 208 FM	74, 75, 292, 392, 395, 402, 408, 577, 591, 596, 604, 607
QJ 209 FM	52, 58, 65, 66, 67, 68, 69, 70, 189, 197, 293, 294, 296, 313, 316, 336, 338, 348, 349, 350, 392, 396, 402, 408, 413, 577, 593, 596, 604, 607
QJ 212 FM	52, 54, 56, 58, 61, 63, 65, 66, 67, 68, 69, 70, 72, 74, 189, 191, 192, 194, 196, 197, 200, 202, 203, 292, 294, 296, 298, 299, 301, 303, 305, 308, 310, 313, 316, 319, 322, 324, 326, 328, 330, 336, 338, 341, 344, 392, 398, 402, 408, 577, 578, 594, 596, 604, 607
QJ 309 FM	52, 54, 56, 58, 61, 63, 65, 66, 67, 68, 69, 70, 72, 74, 75, 189, 190, 191, 192, 194, 196, 198, 200, 201, 202, 203, 292, 293, 294, 295, 296, 298, 300, 302, 304, 306, 308, 311, 313, 316, 319, 322, 325, 327, 328, 331, 336, 339, 341, 344, 349, 350, 392, 396, 402, 408, 578, 579, 591, 595, 596, 604, 607
RMS 9 2RS / C3	579
T 163	50, 186, 220, 221, 226, 392, 396, 406, 412, 580, 582, 583, 584, 604, 606
T 182	44, 46, 49, 50, 186, 188, 222, 223, 224, 227, 246, 250, 260, 261, 392, 396, 406, 412, 580, 582, 583, 584, 588, 589, 590, 591, 604, 606
U 298 / U 261 L	116, 160, 161, 392, 395, 406, 412, 580
U 399 / U 360 L	116, 117, 122, 145, 153, 160, 162, 163, 392, 395, 406, 412, 580
U 497 / U 460 L	160, 392, 396, 406, 412, 580

Introduction

Introdução

Introducción

04

Fersa Bearings

During these last forty five years Fersa Bearings has been able to strengthen its image as an innovative European manufacturing company. Our product and market experience, our R&D capabilities, our access to the latest manufacturing technologies and the efficient management of our supply chain, has positioned Fersa as one of the top suppliers in the global bearing market.

Fersa is present in five continents thanks to an excellent customer service, constant product innovation and the effort to exceed our customers' expectations.

A key element to our global expansion has been the commitment made by our distributors in increasing every year our penetration in the various markets, establishing Fersa as a top brand name in the industry.

Thanks to this joint effort in developing new products and to the constant improvement of our processes we have been able to increase the number of references featured in this catalog.

Innovation, customer support and 40 years of experience are the underlying forces that guarantee the quality of our bearings and of our service; but it is a **passion for quality** that drives Fersa Bearings for constant improvement and customer satisfaction.

It is with this in mind that we hope the information contained in this catalog will be of interest and use to you.

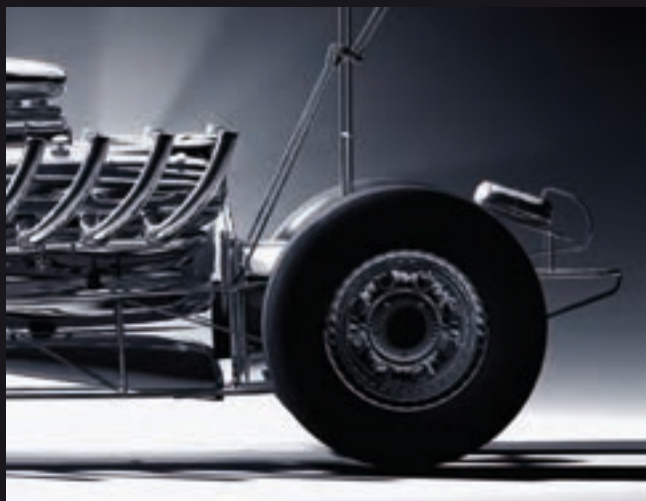

Ao longo dos últimos quarenta e cinco anos, na Fersa Bearings reforçamos a nossa imagem de empresa europeia com carácter inovador, onde a nossa experiência em produto, capacidade de engenharia, acesso às mais altas tecnologias de fabricação e eficiente gestão da cadeia de fornecimento, nos permitiram ocupar atualmente um destacado lugar entre os principais fornecedores deste tipo de produto.

Atualmente estamos presentes nos cinco continentes, graças ao esforço e à dedicação de toda a equipe Fersa, em que o serviço ao cliente, a inovação constante e o esforço diário para excedermos as expectativas em nós depositadas são o nosso principal elemento distintivo.

Um fator fundamental na nossa expansão foi o compromisso adquirido por parte dos nossos distribuidores para potenciar a nossa presença nos diferentes mercados, fazendo da Fersa uma marca de prestígio.

Graças a esta estreita colaboração no desenvolvimento de novos produtos e ao constante melhoramento dos nossos processos, fomos aumentando o número de referências que estão registadas neste catálogo.

A inovação, a assistência aos clientes e a nossa experiência são os nossos principais motores para que possamos garantir a qualidade dos nossos rolamentos e do nosso serviço, sem nos esquecermos de que a **paixão pela qualidade** faz com que na Fersa tenhamos sempre novos desafios a enfrentar.

Por esta razão esperamos que as informações registadas neste catálogo sejam do seu interesse.

A lo largo de los últimos cuarenta y cinco años, en Fersa Bearings hemos potenciado nuestra imagen de fabricante europea con carácter innovador, donde nuestra experiencia en el producto, la capacidad de I+D+i, el acceso a las más altas tecnologías de fabricación y la eficiente gestión de la cadena de suministro, nos han permitido ocupar en la actualidad un destacado lugar entre los principales proveedores de rodamientos.

Actualmente, estamos presentes en los cinco continentes gracias al esfuerzo y la dedicación de todo el equipo Fersa, en el que el servicio al cliente, la innovación constante y el esfuerzo diario por superar las expectativas depositadas en nosotros, son nuestro principal elemento distintivo.

Un factor clave en nuestra expansión ha sido el compromiso adquirido por parte de nuestros distribuidores para potenciar nuestra presencia en los diferentes mercados, haciendo de Fersa, una marca de prestigio.

Gracias a esta estrecha colaboración en el desarrollo de nuevos productos y a la constante mejora de nuestros procesos hemos ido aumentando el número de referencias que quedan recogidas en este catálogo.

La innovación, la asistencia al cliente y nuestros 40 años de experiencia son nuestros principales motores para garantizar la calidad de nuestros rodamientos y de nuestro servicio, sin olvidar que la **pasión por la calidad** hace que en Fersa tengamos siempre nuevos retos que acometer.

Por esta razón esperamos que la información recogida en este catálogo sea útil y de su interés.



- Fersa Bearings is a European bearings manufacturer with more than 45 years experience dedicated to the design, manufacture and distribution of bearings worldwide.
- The headquarters of the company, as well as the central manufacturing plant for Europe is located in Zaragoza, Spain.

Fersa also has a sales/engineering office in Brazil and a distribution network that covers more than 67 countries.
- Because innovation is a constant mainstay of Fersa Bearings, the product catalogs incorporates year after year the new references developed at CBE *Center for Bearings Excellence*.

6% of our sales are invested in R&D every year to provide customers with the latest technological innovations.

- A Fersa Bearings é um fabricante europeu de rolamentos com uma longa experiência de mais de 45 anos de dedicação à inovação, fabricação e distribuição de rolamentos em todo o mundo.
- Os seus escritórios centrais situam-se em Zaragoza, (Espanha) onde se encontra o seu centro de fabricação na Europa.

A Fersa conta, além disso, com um escritório técnico-comercial no Brasil e uma vasta rede de distribuição em mais de 67 países.
- Para a Fersa Bearings a inovação é uma constante e, por isso, o catálogo de produtos vai incorporando, ano após ano, as novas referências desenvolvidas a partir do Centro de excelência de rolamentos, (CBE).

6% das vendas são reinvestidas todos os anos na colocação da nossa capacidade tecnológica inovadora a serviço de nossos clientes.



- *Fersa Bearings es un fabricante europeo de rodamientos con más de 45 años de experiencia dedicado al diseño, la fabricación y distribución de los rodamientos en todo el mundo.*
- *Sus oficinas centrales se localizan en Zaragoza, España, donde se encuentra su centro de fabricación en Europa.*

Fersa cuenta además con una oficina comercial y de ingeniería en Brasil y una extensa red de distribución que cubre mas de 67 países.

- *La innovación es una constante para Fersa Bearings y por ello el catálogo de productos va incorporando año tras año las nuevas referencias desarrolladas desde el Centro de excelencia del rodamiento, (CBE).*

Cada año el 6% de la facturación va dirigido a actividades de I+D para poner al servicio de los clientes los productos de última generación.

05

Bearings for Agricultural Applications

Rolamentos para Aplicações Agrícolas
Rodamientos para Aplicaciones Agrícolas





	OUT	IN		Fersa®	Nº OEM	
---	-----	----	---	---------------	--------	---

AGCO MAXION

Colheitadeira Combinada MF1130 - Arrozadeira * 5650 - Arrozadeira

Eixo Dianteiro / Eje Delantero / Front Axle

Mancal / Cojinete / Bearing			MR * MRO 243 0 1.5/8"	3982 / 3920		TRB
Roda / Rueda / Wheel	•			387A / 382A		TRB

Colheitadeira Combinada Automotriz (1170DS * 1175DS) * 1630 Arrozadeira * 3640 Arrozadeira * 5650 * MF 220A * 220CBD * 220STD * MF 310CBD * 310STD * 210 * 210S * 220 * 310

Batedor Traseiro / Bastidor Trasero / Rear Chassis

Acionador / Accionador / Drive				6309 2RS	391069X1	BB
Direito / Derecho / Right				6309 2RS	880006254312	BB

Eixo Dianteiro / Eje Delantero / Front Axle

Roda / Rueda / Wheel				6309 2RS	391968X1	BB
----------------------	--	--	--	-----------------	----------	----

Eixo Traseiro / Eje Trasero / Rear Axle

Roda / Rueda / Wheel				6209 2RS	339601X1	BB
Esquerdo / (izq.) / Left				6310 2RS	880006254313	BB
Tração / Tracción / Traction				6206 2RS	880006254208	BB
Variador / Variador / Drive				6202 2RS	1440487X1	BB
				6309 2RS	391968X1	BB
				6008 2RS		BB
				6308 2RS		BB

Câmbio / Cambio / Gearbox

			ZF 3MD30/3MD30V	6211 ZNR		BB
				6206 2RS		BB
				6308 2RS		BB
Eixo intermediário (dianteiro) / Eje intermedio (delantero) / Intermediate shaft (front)			ZF 3MD30/3MD30V	6307 NR	880006250310	BB
Eixo intermediário (esq.) / Eje intermedio (izq.) / Intermediate shaft (left)			ZF 3MD30/3MD30V	NJ 309 FM / C3	3175306M1	CR
Eixo oco (dianteiro/traseiro) / Eje hueco (delantero/traseiro) / Hollow shaft (front/rear)			ZF 3MD30/3MD30V	6010	1440551X1	BB
Eixo primário (dianteiro) / Eje primario (delantero) / Primary shaft (front)			ZF 3MD30/3MD30V	6307 NR	317423M1	BB
			ZF 3MD30/3MD30V	NJ 309 FM	3175306M1	CR
Eixo primário (dir./esq.) / Eje primario (der./izq.) / Primary shaft (left/right)			ZF 3MD30/3MD30V	6307 NR	880006250310	BB
Eixo primário (traseiro) / Eje primario (trasero) / Primary shaft (rear)			ZF 3MD30/3MD30V	6211 / C3	352983X1 / ZF635333039	BB
Eixo secundário (traseiro) / Eje secundario (trasero) / Secondary shaft (rear)			ZF 3MD30/3MD30V	LM 67048 / LM 67010		TRB
Eixo variador - (dianteiro/traseiro) / Eje variador (delantero/traseiro) / Drive shaft (front/rear)			ZF 3MD30/3MD30V	6309	3275088M1	BB
Engr. planetária - flange (dir./esq.) / Engr. Planetario - brida (der./izq.) / Planetary gear - flange (right/left)			ZF 3MD30/3MD30V	6208	339818M1	BB
Lateral da coroa (dir.) / Lateral de corona (der.) / Crown gear (right)			ZF 3MD30/3MD30V	6208	339818M1	BB
Lateral da coroa (esq.) / Lateral de corona (izq.) / Crown gear (left)			ZF 3MD30/3MD30V	6311 / C3	1440561X1	BB

Canal de Descarga / Canal de Descarga / Discharge Channel

Conjunto de engrenagem / Conjunto de engranaje / Gear assembly				6204 2RS	88-000625-4.204	BB
--	--	--	--	-----------------	-----------------	----

	OUT	IN		Fersa [®]	N° OEM	
---	-----	----	---	---------------------------	--------	---

AGCO MAXION

Colheteira Combinada Automotriz (1170DS * 1175DS) * 1630 Arrozadeira * 3640 Arrozadeira * 5650 * MF 220A * 220CBD * 220STD * MF 310CBD * 310STD * 210 * 210S * 220 * 310

Canal Elevador de Grãos / Canal Elevador de Granos / Grain Elevator Channel

Conjunto tensor - eixo inferior / Conjunto tensor - eje inferior / Tensor assembly - lower shaft				6204 2RS	88-000625-4.204	BB
--	--	--	--	-----------------	-----------------	----

Cilindro da Trilha / Cilindro de Camino / Trail Cylinder

Tração / Tracción / Traction				6305 2RS	880006254306	BB
------------------------------	--	--	--	-----------------	--------------	----

Cilindro de Dentes / Cilindro de Dientes

Eixo / Eje / Shaft				6309 2RS	880006254312	BB
--------------------	--	--	--	-----------------	--------------	----

Conjunto da Trilha / Conjunto de Camino / Trail group

				6309 2RS	880006254312	BB
--	--	--	--	-----------------	--------------	----

Conjunto Saca-palha / Conjunto Saca-Paja / Straw Extractor

Eixo de tração / Eje de tracción / Traction shaft				6011	880006250314	BB
---	--	--	--	-------------	--------------	----

Eixo do rotor / Eje de rotor / Rotor shaft				6307 RS	1441561X1	BB
--	--	--	--	----------------	-----------	----

Eixo polia - sup. Embreagem conj. tensor / Eje polea - sup. embrague conj. tensor / Pulley shaft - clutch tensor assembly upper				6206 2RS	880006254208	BB
---	--	--	--	-----------------	--------------	----

Filtro rotat. - eixo hélice / Filtro rotat. - eje hélice / Filter - propshaft				6204 2RS	88-000625-4.204	BB
---	--	--	--	-----------------	-----------------	----

Tensor de corrente / Tensor de corriente / Current tensor				6204 2RS	88-000625-4.204	BB
---	--	--	--	-----------------	-----------------	----

Corpo Principal / Cuerpo Principal						
------------------------------------	--	--	--	--	--	--

Polias esticadoras / Polea tensora / Tensioner pulley				6203 2RS	1440487X1	BB
---	--	--	--	-----------------	-----------	----

Diferencial / Diferencial / Differential						
--	--	--	--	--	--	--

Coroa (dir./esq.) / Corona (der./izq.) / Crown (left/right)				6210 2RS	1440572X1	BB
---	--	--	--	-----------------	-----------	----

Engr. planetária - coroa (esq.) / Engr. Planetario - corona (izquierda) / Planetary gear - crown (left)				6311/C3		BB
---	--	--	--	----------------	--	----

Eixo Dianteiro / Eje Delantero / Front Axle

Roda / Rueda / Wheel				LM 501349 / LM 501310		TRB
	•	•		45284 / 45220		TRB
				6310	880006250313	BB

Eixo Traseiro / Eje Trasero / Rear Axle

Roda / Rueda / Wheel	•			30208 F	880007200119	TRB
	•			LM 11949 / LM 11910		TRB
		•		32210 F	880007200321	TRB
		•		LM 48548 / LM 48510		TRB

Elevador de Descarga / Elevador de Descarga / Discharge Elevator

Embreagem - conjunto engr. / Embrague - conjunto engr. / Clutch - gear assembly				6204 2RS	88-000625-4.204	BB
---	--	--	--	-----------------	-----------------	----

Embreagem - conjunto tensor / Embrague - conjunto tensor / Clutch - tensor assembly				6206 2RS	880006254208	BB
---	--	--	--	-----------------	--------------	----

Elevador de Grãos / Elevador de Granos / Grain Elevator

Acionamento / Accionamiento / Drive				6203 2RS	1440487X1	BB
				6204 2RS	1440487X1	BB

	OUT	IN		Fersa®	N° OEM	
---	-----	----	---	---------------	--------	---

AGCO MAXION

Colhedeira Combinada Automotriz (1170DS * 1175DS) * 1630 Arroeira * 3640 Arroeira * 5650 * MF 220A * 220CBD * 220STD * MF 310CBD * 310STD * 210 * 210S * 220 * 310

Elevador de Retilha / Elevador de Trilla

Conjunto suporte / Conjunto soporte / Support assembly				6206 2RS	880006254208	BB
				6204 2RS		BB

Embreagem / Embrague / Clutch

				6304 2RS		BB
				6210 2RS	880006253312	BB
Carcaça / Carcasa / Housing				6309 2RS	880006253312	BB
Polia / Polea / Pulley				6207 2RS		BB
Tampa / Cubierta / Cover				6009 2RS	3315033M1	BB

Espalhador de Palha / Esparcidor de Paja / Straw Spreader

Eixo da polia / Eje de polea / Pulley shaft				6204 Z	1440489X1	BB
Eixo do funil / Eje de tolva / Hopper shaft				6205 Z	1440491X1	BB
Polia da correia / Polea de correia / Belt pulley				6204 Z	1440489X1	BB

Limpeza / Limpieza / Cleaning

Acionador das peneiras / Accionador de tamices / Sieves drive				6204 2RS		BB
				6205 2RS		BB
Acionador das peneiras - suporte biela / Accionador de tamices - soporte biela / Sieves drive - rod support				6206 2RS	339583X1	BB
Acionador peneiras - eixo polia / Accionador de tamices - eje polea / Sieves drive - pulley shaft				6206 2RS	339583X1	BB
Conjunto tensor / Conjunto tensor / Tensor assembly				6206 2RS	880006254208	BB
Ventilador- eixo polia / Ventilador- eje polea / Fan - pulley shaft				6203 2RS	1483635M1	BB

Motor / Motor / Engine

Bomba d'água / Bomba de agua / Water pump				6302 Z		BB
				6305 2RS		BB
Dinamo / Dinamo / Dinamo				6203 Z	488952M2	BB
Dinamo (dianteiro) / Dinamo (delantero) / Dinamo (front)				6303 Z		BB
Eixo - polia menor / Eje - polea menor / Shaft - smaller pulley				6206 2RS	880006254208	BB
Radiador / Radiador / Radiator				6004 2RS		BB
Variador do ventilador / Variador de ventilador / Fan drive				6208 2RS	880006254211	BB

Plataforma de Milho / Plataforma de Maiz / Corn Platform

Caixa transm. - engrenagem / Caja transm. - engranaje / Transfer case - gear				6209 2RS	MF339601X1	BB
Caixa transm. - pinhão / Caja transm. - piñón / Transmission box - pinion				6206 2RS	880006254208	BB

Plataforma Dianteira / Plataforma Delantera / Front Platform

				6306 2RS		BB
				6210 2RS	1440572X1	BB
				6202 2RS	339932X1	BB
Acionam. facas - eixo garfo / Accionamiento de palanca - eje palanca / Lever drive - lever shaft				6205 2RS	22258X	BB
Acionamento da descarga do tanque / Accionamiento de descarga de tanque / Tank discharge drive				6205 2RS	22258X	BB



OUT IN



Fersa®

N° OEM



AGCO MAXION

Colhetadeira Combinada Automotriz (1170DS * 1175DS) * 1630 Arroeira * 3640 Arroeira * 5650 * MF 220A * 220CBD * 220STD * MF 310CBD * 310STD * 210 * 210S * 220 * 310

Plataforma Dianteira / Plataforma Delantera / Front Platform

Molinete acionado por correia - eixo polia (dianteira) / Molinete accionado por correia - eje polea (delantera) / Belt-driven windlass (front) pulley shaft				6202 2RS	339932X1	BB
				6006 2RS	320291X1	BB
Molinete acionado por corrente - eixo polia (dianteira) / Molinete accionado por corriente - eje polea (delantera) / Power - driven windlass pulley shaft (front)				6004 2RS	391057X1	BB
Molinete acionado por corrente - suporte (dianteiro) / Molinete accionado por corriente - soporte (delantera) / Power - driven windlass support (front)				6203 2RS	1440487X1	BB
Molinete acionado por corrente - suporte (traseira) / Molinete accionado por corriente - soporte (trasera) / Power - driven windlass support (rear)				6004 2RS	391057X1	BB

Plataforma Flexível / Plataforma Flexível / Flexivel Platform

Conj. eixo comando (dir.) / Conj. eje comando (der.) / Command shaft assembly - right				32210 F	880007200321	TRB
Conj. eixo comando (esq.) / Conj. eje comando (izq.) / Command shaft assembly - left				32210 F	880007200321	TRB
Conj. engr. - lim. de toque / Conj. engr. - limitador de par / Gear assembly - torque limiter				6204 2RS	88-000625-4.204	BB
Eixo de comando (esquerdo / direito) / Eje de comando ((izq.) / derecho) / Command shaft (left/right)				30205 F	880007200116/ MF339482X1	TRB

Tanque de Grãos / Tanque de Granos / Grain Tank

Acionam. descarga tanque / Accionam. descarga tanque / Tank discharge drive				6208 2RS		BB
Acionam. descarga tanque - eixo polia / Accionam. descarga tanque - eje polea / Tank discharge drive - pulley shaft				6209 2RS	339601X1	BB
Eixo (dianteiro) / Eje (delantera) / Shaft (front)				6207 2RS	88-000625-4.210	BB
Eixo (traseiro) / Eje (trasero) / Shaft (rear)				6207 2RS	88-000625-4.210	BB
Embreagem - eixo mancal / Embrague - eje cojinete / Clutch - bearing shaft				6008 2RS	339780X1	BB
Embreagem - eixo polia / Embrague - eje polea / Clutch - pulley shaft				6306 2RS	390384X1	BB
Transm. tubo desc. - eixo sup. / Transm. tubo desc. - eje sup. / Discharge tube transmission - upper shaft				6204 2RS	339599X1	BB
Transm. tubo desc. - pinhão flange / Transm. tubo desc. - piñón brida / Discharge tube transmission - flange pinion				6206 2RS	339583X1	BB
Transm. tubo descarga - eixo inf. / Transm. tubo descarga - eje inf. / Discharge tube transmission - low shaft				6205 2RS	22258X	BB
Transm. tubo descarga - eixo superior / Transm. tubo descarga - eje superior / Discharge tube transmission - upper shaft				6204 2RS	339599X1	BB

Tomada de Potência / Toma de Potencia / Power Take-off

Acionamento (traseiro) / Accionamiento (trasero) / Drive (rear)		13830		6011 ZZ	834218M1	BB
Eixo alavanca da correia / Eje palanca de correia / Belt lever shaft				6309 2RS	391069X1	BB
Eixo da polia / Eje de polea / Pulley shaft				6206 2RS	339583X1	BB
Eixo primário (dianteiro/traseiro) / Eje primario (delantera/trasero) / Primary shaft (front/rear)		MWM * Perkins		LM 67048 / LM 67010	880008950020	TRB
Eixo secundário (traseiro) / Eje secundario (trasero) / Secondary shaft (rear)		MWM * Perkins		LM 67048 / LM 67010	880008950020	TRB
				6204 2RS		BB
				6211 2RS		BB
				6306 2RS		BB

	OUT	IN		Fersa®	Nº OEM	
---	-----	----	---	---------------	--------	---

AGCO MAXION

Colhedeira Combinada Automotriz 1170DS * 1175DS * 1630 Arroeira * 3640 Arroeira * 5650 * MF 220A * 220CBD * 220STD * MF 310CBD * 310STD * 210 * 210S * 220 * 310

Tração do Carregador / Tracción de Cargador / Traction Charger

Embreagem - conjunto tensor / Embrague - conjunto tensor / Clutch - tensor assembly				6206 2RS	880006254208	BB
Guia do eixo / Guía de eje / Guide shaft				6206 2RS	339583X1	BB
				6207 2RS		BB
				6309 2RS	391968X11	BB
				6212 2RS		BB

Diversos

Câmbio / Cambio / Gearbox

Tomada de força / Toma de fuerza / Power take-off				6210 Z		BB
---	--	--	--	---------------	--	----

Tanque de Grãos / Tanque de Granos / Grain Tank

Acionam. descarga tanque / Accionam. descarga tanque / Tank discharge drive				6009 2RS		BB
---	--	--	--	-----------------	--	----

Roçadeira MF 880

Motor / Motor / Engine

Eixo do rotor (superior/inferior) / Eje de rotor (superior/inferior) / Rotor shaft (upper/lower)				25590 / 25522		TRB
Roda guia (interno/externo) / Rueda guía (externo/interno) / Idler wheel (outer/inner)				LM 11949 / LM 11910		TRB

Tratores MF 235 (4 x 4) antigo * MF235 Moderno * 250 * 265 * MF 265 RD * 270 * 274 * 275 * 285 * 290 * MF 292 (4 x 4) * 295 * 296 * 299

Acionador da Polia / Accionador de Polea / Drive Pulley

				LM 48548 / LM 48510		TRB
				LM 603049 / LM 603011		TRB
Lateral da coroa / Lateral de corona / Crown gear				LM 11949 / LM 11910	831054M1 / 831055M1 / 895322M91	TRB

Câmbio / Cambio / Gearbox

				6008	390985X1	BB
Carretel (dianteiro) / Carrete (delantero) / Reel (front)				6211 Z		BB
Eixo Intermediário (traseiro) / Eje intermedio (trasero) / Intermediate shaft (rear)				LM 48548 / LM 48510		TRB
Eixo principal (traseiro) / Eje principal (trasero) / Main shaft (rear)				LM 11949 / LM 11910		TRB
Pinhão da polia (traseiro) / Piñón de polea (trasero) / Pulley pinion (rear)				LM 48548 / LM 48510		TRB

Canal Elevador de grãos / Canal Elevador de Granos / Grain Elevator Channel

				6203 2RS		BB
--	--	--	--	-----------------	--	----

Conjunto Sacapalha / Conjunto Sacapaja / Straw Extractor

Acionamento do eixo / Accionamiento de eje / Shaft drive				6307 RS	1441561X1	BB
--	--	--	--	----------------	-----------	----

Diferencial / Diferencial / Differential

Diferencial - lateral da coroa (dir./esq.) / Diferencial - lateral de corona (der./izq.) / Differential - crown gear (left/right)				3984 / 3920		TRB
Engrenagem planetária - lateral coroa (esq.) / Engranaje planetaria - lateral corona (izq.) / Planetary gear - crown gear (left)				6311 C3		BB

	OUT	IN		Fersa [®]	N° OEM	
---	-----	----	---	---------------------------	--------	---

AGCO MAXION

Tratores MF 235 (4 x 4) antigo * MF235 Moderno * 250 * 265 * MF 265 RD * 270 * 274 * 275 * 285 * 290 * MF 292 (4 x 4) * 295 * 296 * 299

Eixo Dianteiro / Eje Delantero / Front Axle

Diferencial - lateral da coroa (dir./esq.) / Diferencial - lateral corona (der./izq.) / Differential - crown gear (left/right)			MF235 * 265	LM 501349 / LM 501310		TRB
(Dir./esq.) / (Der./izq.) / (Right/left)			MF 265 4x4 * MF 274 4x4 * MF290 * MF292 4x4	30210 F		TRB
Pinhão (dianteiro) / Piñón (delantero) / Pinion (front)				M 802048 / M 802011		TRB
Roda / Rueda / Wheel	•			LM 11949 / LM 11910	831054M1 / 831055M1 / 895322M91	TRB
		•		LM 48548 / LM 48510	831077M1 / 831078M1 / 1851800M91	TRB

Eixo Traseiro / Eje Trasero / Rear Axle

Diferencial - lateral da coroa (dir./esq.) / Diferencial - lateral corona (der./izq.) / Differential - crown gear (left/right)			MF 235 4x4	3984 / 3920		TRB
Diferencial - lateral da coroa (esq.) / Diferencial - lateral corona (izq.) / Differential - crown gear (left)				3984 / 3920		TRB

Embreagem / Embrague / Clutch

				6203 ZZ		BB
Polia / Polea / Pulley				6306 2RS	390384X1	BB
				6307 2RS	354920X1	BB
				6009 2RS	3315033M1	BB
Tampa / Cubierta / Cover				6009 2RS	3315033M1	BB

Motor / Motor / Engine

Alternador (dianteiro) / Alternador (delantero) / Alternator (front)				6303 RS / C3		BB
Árvore de manivela - ponta / Cigüeñal - punta / Crankshaft - tip				6203 ZZ	488952M2	BB
Bomba d'água (dianteiro/traseiro) / Bomba de agua (delantero/trasero) / Water pump - (front/rear)				6204 ZZ		BB
Dinamo (dianteiro/traseiro) / Dinamo (delantero/trasero) / Dinamo (front/rear)				6203 ZZ	488952M2	BB

Tomada de Potência / Toma de Potencia / Power Take-off

				6008 2RS		BB
Coroa da polia (dianteiro) / Corona de polea (delantero) / Pulley crown (front)				LM 603049 / LM 603011		TRB
Coroa da polia (traseiro) / Corona de polea (trasero) / Pulley crown (rear)				LM 11949 / LM 11910		TRB
Pinhão da polia (traseiro) / Piñón de polea (trasero) / Pulley pinion (rear)				LM 48548 / LM 48510		TRB
Acionamento (traseiro) / Accionamiento (trasero) / Drive (rear)				6011 ZZ	834218M1	BB
Coroa da polia (dianteiro) / Corona de polea (delantero) / Pulley crown (front)				LM 603049 / LM 603011		TRB
Coroa da polia (traseiro) / Corona de polea (trasero) / Pulley crown (rear)				LM 11949 / LM 11910		TRB
Eixo principal (traseiro) / Eje principal (trasero) / Main shaft (rear)				LM 11949 / LM 11910		TRB

	OUT	IN		Fersa®	Nº OEM	
---	-----	----	---	---------------	--------	---

AGCO MAXION

Tratores MF 235 (4 x 4) antigo * MF235 Moderno * 250 * 265 * MF 265 RD * 270 * 274 * 275 * 285 * 290 * MF 292 (4 x 4) * 295 * 296 * 299

Tração Dianteira / Tracción Delantera / Front Traction

Coroa (dir./esq.) / Corona (der./izq.) / Crown (left/right)			4 x 4	30210 F		TRB
Eixo variador / Eje variador / Drive shaft			4 x 4	6307		BB

Tratores MF (50X * 55X * 65R * 65X * 85 * 85X * 95 * 95X)

Acionador da Polia / Accionador de Polea / Drive Pulley

				6206 Z		BB
Coroa da polia (dianteiro) / Corona de polea (delantero) / Pulley crown (front)				LM 603049 / LM 603011		TRB
Coroa da polia (traseiro) / Corona de polea (trasero) / Pulley crown (rear)				LM 11949 / LM 11910	831054M1 / 831055M1 / 895322M91	TRB
Pinhão da polia (traseiro) / Piñón de polea trasero / Rear pulley pinion				LM 48548 / LM 48510		TRB

Câmbio / Cambio / Gearbox

				6211 ZNR		BB
				6203 ZZ		BB
Carretel (dianteiro) / Carrete (delantero) / Reel (front)				6211 Z		BB
Eixo intermediário (traseiro) / Eje intermedio (trasero) / Intermediate shaft (rear)				LM 48548 / LM 48510		TRB
Eixo principal (traseiro) / Eje principal (trasero) / Main shaft (rear)				LM 11949 / LM 11910		TRB
Eixo secundário (dianteiro/traseiro) / Eje secundario (delantero/trasero) / Secondary shaft (front/rear)				6208 ZZ	195592M2	BB
Eixo tomada potência (dianteira / traseira) / Eje toma potencia (delantera / trasera) / Power take-off shaft (front/rear)				6010 Z	195494M1	BB

Eixo Dianteiro / Eje Delantero / Front Axle

Roda / Rueda / Wheel	•			LM 11949 / LM 11910	831054M1 / 831055M1 / 895322M91	TRB
		•		LM 48548 / LM 48510	831077M1 / 831078M1 / 1851800M91	TRB

Eixo traseiro / Eje Trasero / Rear Axle

Diferencial - lateral da coroa (dir.) / Diferencial - lateral de corona (der.) / Differential - crown gear (right)				39590 / 39520		TRB
Diferencial - lateral da coroa (esq.) / Diferencial - lateral de corona (izq.) / Differential - crown gear (left)				3984 / 3920		TRB
Diferencial - lateral da coroa (dir./esq.) / Diferencial - lateral de corona (der./izq.) / Differential - crown gear (left/right)			MF 50X	3984 / 3920		TRB

Embreagem / Embrague / Clutch

				6203 ZZ		BB
--	--	--	--	----------------	--	----

Motor / Motor / Engine

Árvore de manivela - ponta / Cigüeñal - punta / Crankshaft - tip				6203 ZZ	488952M2	BB
Bomba d'água (dianteiro/traseiro) / Bomba de agua (delantero/trasero) / Water pump - (front/rear)				6302 Z		BB
			85 * 95	6304 ZZ		BB
Bomba d'água - polia / Bomba de agua - polea / Water pump - pulley				6203 ZZ	488952M2	BB

	OUT	IN		Fersa®	Nº OEM	
---	-----	----	---	---------------	--------	---

AGRALE

Diversos

Motor / Motor / Engine

Virabrequim (dianteiro) / Cigüeñal (delantero) / Crankshaft (front)			M80 * M85 * M90	NJ 309 C3	4001038009007	CR
Virabrequim (traseiro) / Cigüeñal (trasero) / Crankshaft (rear)			M80 * M85 * M90	NUP 309 C3	4001038010025	CR

M80 * M85 * M90

Embreagem / Embrague / Clutch

				6204 ZZ		BB
--	--	--	--	----------------	--	----

Tratores 4100 * 4200 * 4300 * T145 * T146 * T415 * T420

Câmbio / Cambio / Gearbox

			4100/T415/416	6007	4001018002000	BB
Carretel (dianteiro) / Carrete (delantero) / Reel (front)				6305	4001019020000	BB
Carretel (traseiro) / Carrete (trasero) / Reel (rear)				6303	4001019018005	BB
Coroa (dir./esq.) / Corona (der./izq.) / Crown (left/right)			4100/T415/416	6013		BB
			4200/4300	30208 F	4001032057006	TRB
Coroa (direito) / Corona (derecho) / Crown (right)				6206 ZZ	4001018054001	BB
Pinhão / Piñón / Pinion			4100/T415/416	30203 F	4001032052007	TRB
Pinhão (dianteiro) / Piñón (delantero) / Pinion (front)				6004		BB
				6305 C3	4001019020001	BB
				30203 F	4001032052007	TRB
Pinhão / Piñón / Pinion			4100/T415/416	30305 F	4001033054002	TRB

Eixo Cardan / Eje Cardan / Cardan Shaft

			4100/T415	6204 ZZ		BB
Suporte / Soporte / Support			4200/4300	6205 ZZ	4001018052021	BB
Traseiro / Trasero / Rear			T415/416	6304		BB

Eixo Dianteiro / Eje Delantero / Front Axle

Diferencial - pinhão (dianteiro) / Diferencial - piñón (delantero) / Differential - pinion (front)				30203 F		TRB
Diferencial - pinhão (traseiro) / Diferencial - piñón (trasero) / Differential - pinion (rear)				30205 F		TRB
Roda / Rueda / Wheel	•			30205 F	4001032054003	TRB
		•		30207 F	4001032056008	TRB

Eixo Traseiro / Eje Trasero / Rear Axle

Roda / Rueda / Wheel	•		4200/4300	6211	4001018059000	BB
	•	•	4100/T415/416	6210	4001018058002	BB

Embreagem / Embrague / Clutch

				6205 ZZ		BB
Tubo guia / Tubo guía / Guide tube				6206		BB

Motor / Motor / Engine

Dinamo (dianteiro) / Dinamo (delantero) / Dinamo (front)				6303 Z		BB
Dinamo (dianteiro/traseiro) / Dinamo (delantero/trasero) / Dinamo (front/rear)				6202 Z		BB
Dinamo (traseiro) / Dinamo (trasero) / Dinamo (rear)				6201 Z		BB
Virabrequim / Cigüeñal / Crankshaft			M90	6304	4001019019003	BB
			M790	6305 C3	4001019020001	BB

Redução / Reducción / Reduction

				6208 ZZ	4001018057004	BB
				6306	4001019021009	BB

	OUT	IN		Fersa®	Nº OEM	
---	-----	----	---	---------------	--------	---

BALDAN

Arado Escarificador AETC * AETH

Arado / Arado / Plow

Roda / Rueda / Wheel	•			30207 F		TRB
		•		32210 F		TRB
Seção de discos - mancal a graxa (ext./int.) / Sección de discos - cojinetea grasa (ext./int.) / Disc tension - grease bearing (outboard/inboard)				30210 F		TRB
Seção de discos - mancal a óleo (ext./int.) / Sección de discos - cojinete a Aceite (ext./int.) / Disc section - Oil bearing (outboard/inboard)				30210 F		TRB

Arado Fixo AF

Arado / Arado / Plow

Roda de profundidade (externo) / Rueda de profundidad (externo) / Depth wheel (outer)				30206 F		TRB
				32210 F		TRB
Roda de profundidade (interno) / Rueda de profundidad interno / Depth wheel (inner)				32207 F		TRB
				32212 F		TRB
Roda guia (externo) / Rueda guía (externo) / Wheel guide (outer)				32206 F		TRB

Arado Fixo de AIVECAS AAFL * AAFT

Arado / Arado / Plow

Roda guia (interno) / Rueda guía (interno) / Idler wheel (inner)				30207 F		TRB
Roda de profundidade (externo) / Rueda de profundidad (externo) / Depth wheel (outer)				30206 F		TRB
Roda de profundidade (interno) / Rueda de profundidad interno / Depth wheel (inner)				32207 F		TRB

Arado Reversível ARH

Arado / Arado / Plow

Roda de profundidade (externo) / Rueda de profundidad (externo) / Depth wheel (outer)				30206 F		TRB
Roda de profundidade (interno) / Rueda de profundidad interno / Depth wheel (inner)				30207 F		TRB
Roda guia (externo) / Rueda guía (externo) / Wheel guide (outer)				32206 F		TRB
Roda guia (interno) / Rueda guía (interno) / Idler wheel (inner)				30207 F		TRB
Roda guia / Rueda guía / Guide wheel				32212 F		TRB

Arado Subsolador ASDACR * ASDADR * ASDAH

Arado / Arado / Plow

Mancal (externo/interno) / Cojinete (externo/interno) / Bearing (outboard/inboard)				30210 F		TRB
Roda de profundidade (interno/externo) / Rueda de profundidad (interno/externo) / Depth wheel (inner/outer)				30207 F		TRB
Roda / Rueda / Wheel	•			30207 F		TRB
		•		32210 F		TRB
Suporte de disco de corte (externo/interno) / Soporte de disco de corte (externo/interno) / Cutting disc support (outer/inner)				L 44649 / L 44610		TRB

Arado Subsolador ASTH

Arado / Arado / Plow

Roda de profundidade (interno/externo) / Rueda de profundidad (interno/externo) / Depth wheel (inner/outer)				30207 F		TRB
---	--	--	--	---------	--	-----

	OUT	IN		Fersa®	Nº OEM	
---	-----	----	---	---------------	--------	---

BALDAN

Carpideira CED Tandem * Carpideira Fixa Leve

Arado / Arado / Plow

				32210 F		TRB
Roda / Rueda / Wheel	•			32206 F		TRB
				30207 F		TRB
Roda (externo/interno) / Rueda (externo/interno) / Wheel (outboard/inboard)		•		L 44649 / L 44610		TRB

Grade Aradora GRSG * GTCR * GCRTI * GR * GRI * GRPI * GSPA * GRP * CRI

Arado / Arado / Plow

Mancal a graxa (externo/interno) / Cojinete de graxa (externo/interno) / Grease bearing (outboard/inboard)			GTCR	32212 F		TRB
			GSPA	32216 F		TRB
				32218 F		TRB
Mancal a óleo (externo/interno) / Cojinete de aceite (externo/interno) / Oil bearing (outboard/inboard)			GTCR	32212 F		TRB
			GSPA	32216 F		TRB
				32218 F		TRB
Roda / Rueda / Wheel	•			30207 F		TRB
		•		32210 F		TRB

Grade Laranjeira GLCRL

Grade / Gradeador / Harrows

Roda / Rueda / Wheel	•			30206 F		TRB
		•		30207 F		TRB

Grade Niveladora NVAM * NIVAP * NVCR * SNVAM * SNVAP * SP

Nivelador / Nivelador / Leveler

Mancal a graxa (externo/interno) / Cojinete de graxa (externo/interno) / Grease bearing (outboard/inboard)				30210 F		TRB
Mancal a óleo (externo/interno) / Cojinete de aceite (externo/interno) / Oil bearing (outboard/inboard)				30210 F		TRB
Roda / Rueda / Wheel	•			30206 F		TRB
Roda / Rueda / Wheel		•		30207 F		TRB

Grade super pesada GSPCR

Arado / Arado / Plow

Mancal a graxa (externo/interno) / Cojinete de graxa (externo/interno) / Grease bearing (outboard/inboard)				32218 F		TRB
Mancal a óleo (externo/interno) / Cojinete de aceite (externo/interno) / Oil bearing (outboard/inboard)				32218 F		TRB
Roda / Rueda / Wheel	•			3982 / 3920		TRB

Roçadeira CPL * RD1300 * RD1500 * RD1700 * RPU 1700 * RP1300 * RPP * RPD 3000 * RDU 1500 * RDU1700 * RP 1500 * RP 1700 * RPU 1300 * RPU 1500 * RPD 2700 * RPD 2250

Caixa de Distribuição / Caja de Distribución / Distribution Box

Caixa de distribuição - caixa redutora (externo) / Caja de distribución - caja reductora (externo) / Distribution box - external reduction box				32210 F		TRB
Caixa de distribuição - caixa redutora (interno) / Caja de distribución - caja reductora (interno) / Distribution box - internal reduction box				30207 F		TRB
Pinhão / Piñón / Pinion				32210 F		TRB

Roçadeira / Desbrozadora / Weed Eating

Esticador correia (int. / ext.) / Tensor correia (int. / ext.) / Belt tensioner (inner/outer)				30207 F		TRB
---	--	--	--	----------------	--	-----

	OUT	IN		Fersa [®]	N° OEM	
---	-----	----	---	---------------------------	--------	---

CBT

2070 * 2080 * 2100 * 2105 4 x 2 * 2400 * 24004 x 4 * 2500 * 2600

Câmbio / Cambio / Gearbox

Caixa de redução / Caja de reducción / Reduction box				33205 F		TRB
Caixa intermediária - contra eixo / Caja intermedia contraeje / Countershaft intermediate box				32012 XF		TRB
Diferencial - coroa (dir./esq.) / Diferencial - corona (der./izq.) / Differential - crown (left/right)				42381 / 42584		TRB
Diferencial - pinhão (dianteiro) / Diferencial - piñón (delantero) / Differential - pinion (front)				30203 F		TRB
Eixo acionador (traseiro) / Eje accionador (trasero) / Drive shaft (rear)				32210 F		TRB

Eixo Dianteiro / Eje Delantero / Front Axle

Diferencial - coroa (dir./esq.) / Diferencial - corona (der./izq.) / Differential - crown (left/right)				LM 501349 / LM 501314		TRB
Diferencial - pinhão (dianteiro) / Diferencial - piñón (delantero) / Differential - pinion (front)				M 802048 / M 802011		TRB
Roda / Rueda / Wheel	●		2500 * 2600	32210 F		TRB

Eixo Traseiro / Eje Trasero / Rear Axle

Diferencial - pinhão (dianteiro) / Diferencial - piñón (delantero) / Differential - pinion (front)				M 802048 / M 802011		TRB
Espelho do freio (dir.) / Panel de freno (der.) / Brake panel (right)				6209 2RS	100004061	BB
			2500 * 2600	30312 F		TRB

Motor / Motor / Engine

Alternador (dianteiro) / Alternador (delantero) / Alternator (front)				6303 2RS/C3		BB
Alternador (traseiro) / Alternador (trasero) / Alternator (rear)				6201 2RS/C3		BB
Bomba d'água / Bomba de agua / Water pump				30302 F		TRB
Bomba hidráulica (dianteiro) / Bomba hidráulica (delantero) / Hydraulic pump (front)				6203		BB
Bomba hidráulica (externo) / Bomba hidráulica (externo) / Hydraulic pump (our board)				6204 Z		BB
Bomba hidráulica (interno) / Bomba hidráulica (interno) / Hydraulic pump (inboard)				6202		BB
Bomba hidráulica - acionamento / Bomba hidráulica - accionamiento / Hydraulic pump - drive				6206		BB
Bomba injetora (dianteiro) / Bomba inyectora (delantero) / Injection pump (front)				30203 F		TRB
Bomba injetora (traseiro) / Bomba inyectora (trasero) / Injection pump (rear)				30204 F		TRB
Ventilador / Ventilador / Fan				30302 F		TRB

Tomada de Potência / Toma de Potencia / Power Take-off

Acionador / Accionador / Drive				6212 NR	601203015	BB
--------------------------------	--	--	--	----------------	-----------	----

Todos / Todos / All



Tomada de Potência / Toma de Potencia / Power Take-off

Eixo interno / Eje interno / Internal shaft				6306 NR	601201027	BB
Polia / Polea / Pulley				6008	601201044	BB

Tratores 1000 * 1000 (4 x 4) * 1020 * 1020 (4 x 4) * 1065 * 1065 (4 x 4) * 1090 * 1105

Câmbio / Cambio / Gearbox

Caixa de redução / Caja de reducción / Reduction box				33205 F		TRB
Caixa intermediária - contra eixo / Caja intermedia contraeje / Countershaft intermediate box				32012 XF		TRB
Caixa intermediária saída / Caja intermedia salida / Output intermediate box				32011 XF		TRB

	OUT	IN		Fersa [®]	N° OEM	
---	-----	----	---	---------------------------	--------	---

CBT

Tratores 1000 * 1000 (4 x 4) * 1020 * 1020 (4 x 4) * 1065 * 1065 (4 x 4) * 1090 * 1105

Câmbio / Cambio / Gearbox

Diferencial - coroa (dir./esq.) / Diferencial - corona (der./izq.) / Differential - crown (left/right)				42381 / 42584		TRB
--	--	--	--	----------------------	--	-----

Eixo Dianteiro / Eje Delantero / Front Axle

Diferencial - coroa (dir./esq.) / Diferencial - corona (der./izq.) / Differential - crown (left/right)				30210 F		TRB
			1020 4 x 4	LM 501349 / LM 501510		TRB
Pinhão (dianteiro) / Piñón (delantero) / Pinion (front)				M 802048 / M 802011		TRB
Roda / Rueda / Wheel	•			LM 48548 / LM 48510	900902006	TRB
		•		LM 603049 / LM 603011		TRB

Eixo Traseiro / Eje Trasero / Rear Axle

Diferencial - coroa (dir./esq.) / Diferencial - corona (der./izq.) / Differential - crown (left/right)				33287 / 33462		TRB
				580 / 572	600704011	TRB
Diferencial - pinhão (dianteiro) / Diferencial - piñón (delantero) / Differential - pinion (front)				M 802048 / M 802011		TRB

Motor / Motor / Engine

Alternador (dianteiro) / Alternador (delantero) / Alternator (front)				6303 2RS/C3		BB
Alternador (traseiro) / Alternador (trasero) / Alternator (rear)				6201 2RS/C3		BB
Bomba d'água / Bomba de agua / Water pump				30302 F		TRB
Bomba hidráulica (dianteiro) / Bomba hidráulica (delantero) / Hydraulic pump (front)				6203		BB
Bomba hidráulica (externo) / Bomba hidráulica (externo) / Hydraulic pump (outboard)				6204 Z		BB
Bomba hidráulica (interno) / Bomba hidráulica (interno) / Hydraulic pump (inboard)				6202		BB
Bomba hidráulica - acionamento / Bomba hidráulica - accionamiento / Hydraulic pump - drive				6206	30302A	BB
Bomba injetora (dianteiro) / Bomba inyectora (delantero) / Injection pump (front)				6203		BB
				30203 F		TRB
Bomba injetora (traseiro) / Bomba inyectora (trasero) / Injection pump (rear)				30204 F		TRB
Dinamo / Dinamo / Dinamo				6202 Z		BB
Ventilador / Ventilador / Fan				30302 F		TRB

Plataforma Flexível / Plataforma Flexível / Flexível Platform

Conjunto eixo de comando (esq.) / Conjunto eje de comando (izq.) / Command shaft assembly (left)				32210 F	601201022	TRB
Eixo de comando (dir.) / Eje de comando (der.) / Command shaft (right)				30205 F	601203015	TRB

Tomada de Potência / Toma de Potencia / Power Take-off

Acionador / Accionador / Drive				6212 NR	601203015	BB
Eixo principal / Eje principal / Main shaft				6010 2RS	601201022	BB
				6211 ZNR	601201019	BB
				30208 F		TRB
Polia (dir./esq.) / Polea (der./izq.) / Pulley (right / left)				30208 F		TRB
Traseiro / Trasero / Rear				32210 F		TRB

	OUT	IN		Fersa [®]	N° OEM	
---	-----	----	---	---------------------------	--------	---

CBT

Tratores 8060 (4 x 2) * 8060 (4 x 4) * 8240 * 8240A * 8260 * 8440 * 8450

Câmbio / Cambio / Gearbox

Blindagem (dir./esq.) / Escudo (der./izq.) / Shield (left/right)				HM 218248 / HM 218210		TRB
Caixa de mudanças - acionador (traseiro) / Caja de cambios - accionador (traseiro) / Gearbox - drive (rear)				32210 F		TRB
				32019 XF		TRB
Eixo cônico / Eje cónico / Tapered shaft				31312 F		TRB
Eixo da polia (dir./esq.) / Eje de polea (izq./der.) / Pulley shaft (left/right)				30208 F		TRB

Eixo Dianteiro / Eje Delantero / Front Axle

Diferencial - coroa (dir./esq.) / Diferencial - corona (der./izq.) / Differential - crown (left/right)			4 x 4	30210 F		TRB
Diferencial - pinhão (traseiro) / Diferencial - piñón (traseiro) / Differential - pinion (rear)			4 x 4	6307	2501201054	BB
Manga de eixo / Mango de eje / Stub axle				32208 F		TRB
Roda / Rueda / Wheel	•			LM 48548 / LM 48510	900902006	TRB
		•		LM 603049 / LM 603011		TRB

Eixo Traseiro / Eje Trasero / Rear Axle

Diferencial - coroa (dir./esq.) / Diferencial - corona (der./izq.) / Differential - crown (left/right)				580 / 572	600704011	TRB
Espelho do freio (dir.) / Panel de freno (der.) / Brake panel (right)				6209 2RS	100004061	BB

Limitador de Torque / Limitador de Par / Torque Limiter

Eixo da engrenagem (traseiro) / Eje de engranaje (traseiro) / Gear shaft (rear)			4 x 4	6009	101201027	BB
Eixo prolongador (traseiro) / Eje prolongador (traseiro) / Extension shaft (rear)			4 x 4	6212 NR	601203015	BB

Motor / Motor / Engine

Bomba hidráulica - acionamento / Bomba hidráulica - accionamiento / Hydraulic pump - drive				6206		BB
Bomba hidráulica - acoplamento / Bomba hidráulica - acoplamiento / Hydraulic pump - coupler				6010 2RS	601201022	BB
Bomba hidráulica (traseiro) / Bomba hidráulica (traseiro) / Hydraulic pump (rear)			4 x 4	6206	901201042	BB
Bomba hidráulica - virabrequim / Bomba hidráulica - cigüeñal / Hydraulic pump - crackshaft				6205	901102003	BB
Polia tensora / Polea tensora / Tensioner pulley				6203 ZZ	3200305026	BB

Tomada de Potência / Toma de Potencia / Power Take-off

Acionador / Accionador / Drive				6209	901203041	BB
Eixo de saída / Eje de salida / Output shaft				6210	901203015	BB
Eixo secundário / Eje Secundario / Secondary shaft				6307	250120154	BB
Polia (dir./esq.) / Polea (der./izq.) / Pulley (right / left)				30208 F	901203022	TRB
Traseiro / Trasero / Rear				32210 F	2501201022	TRB



	OUT	IN		Fersa [®]	N° OEM	
---	-----	----	---	---------------------------	--------	---

FNH

923-4

Boca de Milho / Boca de Maiz

6306 BB

Colheitadeiras 4040 * 5030 * 5050 * 8040 * 8055 * TC55 * TC57 * CA1530

Acionamento da Plataforma / Accionamiento de Plataforma / Drive Platform

Satélite (dir.) / Satélite (der.) / Satellite (right) 6205 2RS BB

Batedor / Bastidor / Chassis

Acionamento / Accionamiento / Drive 6205 2RS BB

Dianteiro / Delantero / Front 6309 2RS BB

Eixo / Eje / Shaft 6206 2RS BB

Polia / Polea / Pulley 6205 Z BB

Polia (dianteiro) / Polea (delantero) / Pulley (front) 6206 BB

Polia (traseiro) / Polea (trasero) / Pulley (rear) 6204 2RS BB

Traseiro / Trasero / Rear 6202 2RS BB

Câmbio / Cambio / Gearbox

6307 NR BB

Carretel (dianteiro) / Carrete (delantero) / Reel (front) NJ 309 CR

Carretel (traseiro) / Carrete (trasero) / Reel (rear) 6307 BB

Coroa (dir./esq.) / Corona (der./izq.) / Crown (left/right) 6208 BB

Eixo da polia / Eje de polea / Pulley shaft 30208 F TRB

Eixo secundário (traseiro) / Eje secundario (trasero) / Secondary shaft (rear) 30205 F TRB

Engrenagem (traseiro) / Engranaje (trasero) / Gear (rear) LM 501349 / LM 501310 TRB

Pinhão (dianteiro/traseiro) / Piñón (delantero/trasero) / Pinion (front/rear) 6310 20229990N BB

Satélite (dir.) / Satélite (der.) / Satellite (right) 6205 2RS BB

6311/C3 BB

6308 BB

Variador / Variador / Drive 6309 BB

Cilindro Côncavo de Barras / Cilindro Cóncavo de Barras / Bars Concave Cylinder

6208 2RS BB

6308 2RS BB

6309 2RS BB

Classificador / Clasificador / Sorter Unit

6205 2RS BB

6206 2RS BB

Direção / Dirección / Steering

Coluna / Columna / Column 6004 2RS BB

Roda (int./ext.) / Rueda (int./ext.) / Wheel (inner/outer) 30208 F TRB

Volante / Volante / Steering wheel 6303 2RS BB

6203 2RS BB

Eixo Dianteiro / Eje Delantero / Front Axle

Roda / Rueda / Wheel 8040 32020 XF TRB

• LM 501349 / LM 501310 TRB

• M 12649 / M 12610 TRB

Eixo Traseiro / Eje Trasero / Rear Axle

Roda / Rueda / Wheel • LM 48548 / LM 48510 TRB

	OUT	IN		Fersa [®]	N° OEM	
---	-----	----	---	---------------------------	--------	---

FNH

Colheitadeiras 4040 * 5030 * 5050 * 8040 * 8055 * TC55 * TC57 * CA1530

Eixo Traseiro / Eje Trasero / Rear Axle

Roda / Rueda / Wheel	•	•		30208 F		TRB
----------------------	---	---	--	----------------	--	-----

Elevador de Grãos / Elevador de Granos / Grain Elevator

				6205 2RS		BB
				6206		BB
				6206 2RS		BB

Elevador de Palha / Elevador de Paja / Straw Elevator

				6205 2RS		BB
				6206 2RS		BB

Elevador de Retilha / Elevador de Trilla

				6204 2RS		BB
				6205		BB
				6205 2RS		BB
				6206 2RS		BB

Embreagem / Embrague / Clutch

Disco / Disco / Disc				6203 2RS		BB
Polia / Polea / Pulley				6210 2RS	84995634N	BB
				6210 ZZ		BB

Molinete / Cojinete / Bearing

				6205 2RS		BB
--	--	--	--	-----------------	--	----

Motor / Motor / Engine

Compressor - polia / Compresor - polea / Compressor - pulley				6205 2RS		BB
Compressor de ar (dianteiro) / Compresor de aire (delantero) / Air compressor (front)				6206		BB
Compressor de ar (traseiro) / Compresor de aire (trasero) / Air compressor (rear)				6208		BB
Ventilador / Ventilador / Fan				6205 2RS		BB
Virabrequim (dianteiro) / Cigüeñal (delantero) / Crankshaft (front)				6206		BB
Virabrequim (traseiro) / Cigüeñal (trasero) / Crankshaft (rear)				6208		BB
				6207 2RS		BB

Picador de Palha / Picador de Paja / Straw Chopper



				6202		BB
				6203 2RS		BB
				6205 2RS		BB
				6205 Z		BB
				6206 2RS		BB
				6207 Z		BB
				6305 2RS		BB

Saca-Palhas / Empacadora / Packing

				6205 2RS		BB
				6207 2RS		BB
				6305 2RS		BB

Sem Fim de Descarga / Sinfin de Descarga / Discharge Worm

				6206 2RS		BB
--	--	--	--	-----------------	--	----

	OUT	IN		Fersa®	Nº OEM	
FNH						
Colheitadeiras 4040 * 5030 * 5050 * 8040 * 8055 * TC55 * TC57 * CA1530						
Sistema Neumático / Sistema Neumático / Neumatic System						
				6202		BB
Sobretanque / Sobretanque						
				6206 2RS		BB
Tomada de Ar / Entrada de Aire / Air inlet						
				6007 2RS		BB
				6202 2RS		BB
				6203 2RS		BB
				6205 2RS		BB
				6207 2RS		BB
Tubo de Descarga / Tubo de Descarga / Discharge Tube						
				6205 2RS		BB
				6206 2RS		BB
Variador / Variador / Variable drive						
				6205 2RS		BB
				6207 2RS		BB
Variador de Tração / Variador de Tracción / Traction Variable Drive						
				6206 2RS		BB
Diversos						
Embreagem / Embrague / Clutch						
				30020 XF	412284N	TRB
				6307 2RS	320557N	BB
Todos						
Câmbio / Cambio / Gearbox						
Carretel (dianteiro) / Carrete (delantero) / Reel (front)				6212		BB
Carretel (traseiro) / Carrete (trasero) / Reel (rear)				6211		BB
Engrenagem saída / Engranaje salida / Output gear				LM 501349 / LM 501310		TRB
Entalhado (traseiro) / Palanca (trasera) / Rear lever				30205 F		TRB
Tampa / Cubierta / Cover				6207 2RS		BB
Eixo Dianteiro / Eje Delantero / Front Axle						
Roda / Rueda / Wheel	•			LM 501349 / LM 501310		TRB
		•		M 12649 / M 12610		TRB
Motor / Motor / Engine						
Alternador (dianteiro) / Alternador (delantero) / Alternator (front)				6204 2RS/C3		BB
Tratores 4600 * 4610 * 4630 * 5600 * 5610 * 5630 * 6600 * 6610 * 6630 * 7610 * 7630 * 7810 * 7830 * 8030 * 8BR						
Câmbio / Cambio / Gearbox						
				6308		BB
Eixo da polia (esq.) / Eje de polea (izq.) / Pulley shaft (left)				30208 F		TRB
Eixo motriz / Eje motriz / Drive shaft				498A / 492A		TRB
Eixo secundário / Eje Secundario / Secondary shaft				30205 F		TRB
Eixo secundário (traseiro) / Eje secundario (trasero) / Secondary shaft (rear)				LM 501349 / LM 501310		TRB
Engrenagem / Engranaje / Gear				LM 501349 / LM 501310		TRB

	OUT	IN		Fersa [®]	N° OEM	
---	-----	----	---	---------------------------	--------	---

FNH

Tratores 4600 * 4610 * 4630 * 5600 * 5610 * 5630 * 6600 * 6610 * 6630 * 7610 * 7630 * 7810 * 7830 * 8030 * 8BR

Câmbio / Cambio / Gearbox

Entalhado (dianteiro) / Palanca (delantera) / Lever (front)				6013		BB
Flange / Brida / Flange				6210		BB
Placa superior / Placa superior / Top plate				6305		BB
				6306		BB

Diferencial / Diferencial / Differential

				F 15165	0735370232 / 0735370145	TRBS
--	--	--	--	----------------	----------------------------	------

Eixo Dianteiro / Eje Delantero / Front Axle

Diferencial - lateral da coroa (dir./esq.) / Diferencial - lateral de corona (der./izq.) / Differential - crown gear (left/right)				LM 501349 / LM 501310		TRB
Eixo motriz / Eje motriz / Drive shaft				498A / 492A		TRB
Roda / Rueda / Wheel	•			LM 11949 / LM 11910		TRB
	•			LM 501349 / LM 501310		TRB
		•		30207 F		TRB
		•		LM 48548 / LM 48510	321207N	TRB
		•		M 12649 / M 12610		TRB

Eixo Traseiro / Eje Trasero / Rear Axle

Diferencial - lateral da coroa (esq.) / Diferencial - lateral de corona (izq.) / Differential - crown gear (left)				3984 / 3920		TRB
Roda / Rueda / Wheel		•		594 / 592A		TRB

Embreagem / Embrague / Clutch

				6203 Z		BB
--	--	--	--	---------------	--	----

Motor / Motor / Engine

Bomba d'água (dianteiro/traseiro) / Bomba de agua (delantero/trasero) / Water pump - (front/rear)				6302 Z		BB
Bomba injetora (traseiro) / Bomba inyectora trasero / Injection pump (rear)				30203 F		TRB
Dinamo (dianteiro) / Dinamo (delantero) / Dinamo (front)				6203 ZZ		BB
Dinamo (traseiro) / Dinamo (trasero) / Dinamo (rear)				6202 ZZ		BB

Tomada de Força / Toma de Fuerza / Power Take-off



Caixa planetária (dir./esq.) / Caja planetaria (der./izq.) / Planetary box (left/right)				594 / 592A		TRB
Eixo principal (externo) / Eje principal (externo) / Main shaft (output)				6207		BB
				6209		BB
				6306		BB
				LM 501349 / LM 501310		TRB

Tração Dianteira / Tracción Delantera / Front Traction

Coroa (dir./esq.) / Corona (der./izq.) / Crown (left/right)				LM 501349 / LM 501310		TRB
Pinhão (dianteiro) / Piñón (delantero) / Pinion (front)				M 802048 / M 802011		TRB

Transmissão de Força Dupla / Transmisión de Fuerza Doble / Double Transmission

				6008		BB
				6013		BB

	OUT	IN		Fersa®	Nº OEM	
JOHN DEERE						
Colheiteiras CA1165 * CA1175 * CA1185 * CA1450 * CA1550-02 * CA1550-03						
Carro de Transporte 22 / Carro de Transporte 22						
Roda / Rueda / Wheel	•			30206 F		TRB
		•		30209 F		TRB
Eixo Traseiro / Eje Trasero / Rear Axle						
Roda / Rueda / Wheel	•			30205 F		TRB
	•		CA 1175 / CA1450	30206 F		TRB
		•		30207 F		TRB
		•	CA 1175	30209 F		TRB
		•	CA 1175 / CA1450	30210 F		TRB
Motor de Acionamento Hidrostático / Motor de Accionamiento Hidrostático / Hydrostatic Drive Engine						
Eixo da placa deslizante / Eje de placa deslizante / Sliding plate shaft				3782 / 3720		TRB
Redução / Reducción / Reduction						
Pinhão (dianteiro/traseiro) / Piñón (delantero/trasero) / Pinion (front/rear)				30210 F		TRB
Tomada de Força / Toma de Fuerza / Power Take-off						
Eixo de entrada (dianteiro) / Eje de entrada (delantero) / Input shaft (front)				LM 501349 / LM 501310		TRB
Transmissão / Transmisión / Transmission						
				30308 F		TRB
				30210 F		TRB
Unidade de Separação e Limpeza / Unidad de Separación y Limpeza / Separation and Cleaning Unit						
Polia tensora da trilha / Polea tensora de pista / Track tensor pulley				30204 F		TRB
Unidade de Separação e Limpeza / Unidad de Separación y Limpeza / Separation and Cleaning Unit						
Polia tensora da trilha / Polea tensora de pista / Track tensor pulley				30206 F		TRB
Colheiteiras CA9650 * CA9750 STS						
Caixa de Engrenagens de 2 Velocidades / Caja de Engranajes de 2 Velocidades / 2 Speed Gearbox						
Eixo de acionamento (dianteiro/traseiro) / Eje de accionamiento (delantero/trasero) / Drive shaft (front/rear)				3984 / 3920		TRB
Caixa de Mudanças / Caja de Cambios / Gearbox						
Eixo primário (dianteiro) / Eje primario (delantero) / Primary shaft (front)				3984 / 3920		TRB
Eixo Traseiro / Eje Trasero / Rear Axle						
Ponta de eixo / Punta de eje / Axle tip				M 802048 / M 802011		TRB
Motor de Acionamento Hidrostático / Motor de Accionamiento Hidrostático / Hydrostatic Drive Engine						
Eixo da placa deslizante / Eje de placa deslizante / Sliding plate shaft				3782 / 3720		TRB
Tomada de Força / Toma de Fuerza / Power Take-off						
Eixo de entrada (dianteiro) / Eje de entrada (delantero) / Input shaft (front)				LM 501349 / LM 501310		TRB
Plantadeiras PL 803 * PL805						
Transmissão / Transmisión / Transmission						
Roda (interno/externo) / Rueda (interno/externo) / Wheel (inner/outer)				LM 67048 / LM 67010		TRB
Plantadeiras PL 9200 * PL 9209 * PL9211						
Transmissão / Transmisión / Transmission						
Roda / Rueda / Wheel	•			32206 F		TRB
	•			30206 F		TRB

	OUT	IN		Fersa [®]	N° OEM	
---	-----	----	---	---------------------------	--------	---

JOHN DEERE

Plantadeiras PL 9200 * PL 9209 * PL9211

Transmissão / Transmisión / Transmission

		•		30210 F		TRB
	•	•		LM 67048 / LM 67010		TRB

Unidade de Adubo / Unidad de Fertilizante / Fertilizer Unit

Coulter paralinha curta / Línea corta Coulter / Coulter short line				LM 67048 / LM 67010		TRB
Sulcador de adubo - simples (dir./esq.) / Arado de fertilizante - simples (der./izq.) / Fertilizer plow - simples (left/right)				LM 67048 / LM 67010		TRB

Tratores 5403 * 5600 Aeroportuário * 5605 * 5705 * 6605 * 7500 Aeroportuário * 7505

Eixo Dianteiro / Eje Delantero / Front Axle

Diferencial - lateral da coroa (dir./esq.) / Diferencial - lateral de coroa (der./izq.) / Differential - crown gear (left/right)				30210 F		TRB
Diferencial - pinhão (dianteiro/traseiro) / Diferencial - piñón (delantero/traseiro) / Differential - pinion (front/rear)				32210 F		TRB

Eixo Traseiro / Eje Trasero / Rear Axle

Diferencial - lateral da coroa (dir./esq.) / Diferencial - lateral de coroa (der./izq.) / Differential - crown gear (left/right)				30210 F		TRB
Diferencial - pinhão (dianteiro/traseiro) / Diferencial - piñón (delantero/traseiro) / Differential - pinion (front/rear)				32210 F		TRB
Forquilha de entrada (traseiro) / Palanca de entrada (trasera) / Input lever (rear)				M 802048 / M 802011		TRB

Embreagem / Embrague / Clutch

Engrenagem propulsora (traseira) / Engranaje propulsora (trasera) / Drive gear (rear)				LM 603049 / LM 603011		TRB
Traseiro / Trasero / Rear				387 A / 382 A		TRB

Sistema Hidráulico / Sistema Hidráulico / Hydraulic System

Acionamento da bomba hidráulica pinhão (sup./inf.) / Accionamiento de bomba hidráulica piñón (sup./inf.) / Hydraulic pump drive - pinion (upper/lower)				LM 603049 / LM 603011		TRB
Bomba hidráulica - carcaça (esq.) / Bomba hidráulica carcasa (izq.) / Hydraulic pump - housing (left)				M 12649 / M 12610		TRB

Tomada de Força / Toma de Fuerza / Power Take-off

Caixa do eixo (dir./esq.) / Caja de eje (der./izq.) / Shaft box (left/right)				3984 / 3920		TRB
Coroa / Corona / Crown				3982 / 3920		TRB
Eixo curto porta planetário / Eje corto - planetario / Short shaft - planetary				387A / 382A		TRB
Eixo (dianteiro) / Eje (delantero) / Shaft (front)				3984 / 3920		TRB
Eixo extra longo - porta planetário / Eje extra largo - planetario / Extra-long shaft - planetary				387 A / 382 A		TRB

Diversos

Eixo / Eje / Axle

				M 88048 / M 88010		TRB
				29685 / 29620		TRB
				3586 / 3525		TRB
				LM 104949 / LM 104910		TRB
				LM 104949 / LM 104911		TRB
				LM 104949 / LM 104912		TRB

	OUT	IN		Fersa®	N° OEM	
---	-----	----	---	---------------	--------	---

MARCHESAN

Arado de Aivecas Helicoidais AAH

Embreagem / Embrague / Clutch

Suporte do disco (interno/externo) / Soporte de disco (interno/externo) / Disc support (outer/inner)				30205 F		TRB
--	--	--	--	---------	--	-----

Arado de Aivecas Reversível AAR

Embreagem / Embrague / Clutch

Roda da guia (interno/externo) / Rueda de guía (interno/externo) / Guide wheel (inner/outer)				LM 67048 / LM 67010		TRB
--	--	--	--	---------------------	--	-----

Arado de Aivecas Reversível Pesado AARP

Eixo Traseiro / Eje Trasero / Rear Axle

Roda / Rueda / Wheel		•		32210 F		TRB
	•			30207 F		TRB

Arado Fixo AF * Arado Fixo Canavieiro AFC * Arado Fixo Leve AFL

Eixo Traseiro / Eje Trasero / Rear Axle

				LM 67048 / LM 67010		TRB
				LM 48548 / LM 48510		TRB
Pedestal suporte disco central / traseiro (interno) / Pedestal soporte disco central / trasero (interno) / Central and rear disc support (inner)				3982 / 3920		TRB
Roda da guia (externo) / Rueda de guía (externo) / Guide wheel (outer)				LM 48548 / LM 48510		TRB
Roda da guia (interno) / Rueda de guía (interno) / Guide wheel (inner)				LM 501349 / LM 501314		TRB
Suporte do disco (externo) / Soporte de disco (externo) / Disc support (outer)				32210 F		TRB
				3982 / 3920		TRB
Suporte do disco (interno) / Soporte de disco (interno) / Disc support (inner)				32212 F		TRB

Arado Reversível AR * Arado Reversível com Pistão de Reversão ARPR

Eixo Traseiro / Eje Trasero / Rear Axle

Suporte do disco dianteiro / traseiro (externo) / Soporte de disco delantero / trasero (externo) / Front and rear disc support (outer)				32210 F		TRB
--	--	--	--	---------	--	-----

Arado Reversível AR * Arado Reversível com Pistão de Reversão ARPR

Eixo Traseiro / Eje Trasero / Rear Axle

Suporte do disco dianteiro / traseiro (externo) / Soporte de disco delantero / trasero (externo) / Front and rear disc support (outer)				32212 F		TRB
--	--	--	--	---------	--	-----

Arado Subsolador com Desarme Automático AST * MATIC E 500

Eixo Traseiro / Eje Trasero / Rear Axle						
Mancal (externo/interno) / Cojinete (interno/externo) / Bearing (outboard/inboard)				30210 F		TRB
Roda / Rueda / Wheel	•			30207 F		TRB
		•		32210 F		TRB

Arado Subsolador Hidráulico Tatu AST * Arado Subsolador Mecânico Tatu AST



Eixo Traseiro / Eje Trasero / Rear Axle

Roda / Rueda / Wheel		•		3982 / 3920		TRB
----------------------	--	---	--	-------------	--	-----

Cobertura para Plantio Direto CPD * CPD2

Eixo Traseiro / Eje Trasero / Rear Axle

Roda guia (interno/externo) / Rueda guía (externo/interno) / Idler wheel (outer/inner)				30204 F		TRB
--	--	--	--	---------	--	-----

	OUT	IN		Fersa®	N° OEM	
---	-----	----	---	---------------	--------	---

MARCHESAN

Distribuidor de Calcário & Adubo DCA 2 2500 * DCA 2 5500 * DCA 2 7500 * DCA DC 5500 * DCA DC 7500 * DCA DC 2500

Caixa de Redução / Caja de Reducción / Reduction Box

Eixo sem fim (dianteiro) / Eje sin fin (delantero) / Worm shaft (front)				LM 48548 / LM 48510		TRB
---	--	--	--	----------------------------	--	-----

Eixo Traseiro / Eje Trasero / Rear Axle

Roda / Rueda / Wheel	•			30207 F		TRB
		•		32210 F		TRB

Distribuidor de Calcário & Composto Orgânico DCC0 10500 * DCC0 2500 * DCC0 5550 * DCC0 7500

Caixa de Redução / Caja de Reducción / Reduction Box

Roda / Rueda / Wheel	•			30207 F		TRB
		•		32210 F		TRB

Eixo sem fim (dianteiro) / Eje sin fin (delantero) / Worm shaft (front)				LM 48548 / LM 48510		TRB
---	--	--	--	----------------------------	--	-----

Grade Aradora Controle Remoto GACM

Caixa de Redução / Caja de Reducción / Reduction Box

Mancal MR 225 / Cojinete MR 225 / MR 225 bearing				368A / 362A		TRB
Mancal MRO 243 / Cojinete MRO 243 / MRO 243 bearing				3984 / 3920		TRB

Grade Aradora Controle Remoto Offset

Caixa de Redução / Caja de Reducción / Reduction Box

Roda / Rueda / Wheel	•			2780 / 2720		TRB
Roda / Rueda / Wheel		•		3780 / 3720		TRB
Seção de discos (dianteiro/traseiro) / Sección de discos (delantero/trasero) / Disc section - (front/rear)				32212 F		TRB

Grade Aradora GA

Caixa de Redução / Caja de Reducción / Reduction Box

Mancal CM GX 225 (dianteiro/traseiro) / Cojinete CM GX 225 (delantero/trasero) / CM GX 225 bearing (front/rear)				30212 F		TRB
Mancal DM OL / Cojinete DM OL / DM OL bearing				3982 / 3920		TRB

Grade Aradora Hidráulica GAH

Caixa de Redução / Caja de Reducción / Reduction Box

Mancal MRO 243 / Cojinete MRO 243 / MRO 243 bearing				3984 / 3920		TRB
---	--	--	--	--------------------	--	-----

Grade Aradora Intermediária Controle Remoto GAICR * GAICR 300

Caixa de Redução / Caja de Reducción / Reduction Box

Roda / Rueda / Wheel	•			30207 F		TRB
	•			3780 / 3720		TRB
		•		3780 / 3720		TRB
		•		32210 F		TRB
Mancal CM GX 262, DM OL 262 (dianteiro/traseiro) / Cojinete CM GX 262, DM OL 262 (delantero/trasero) / CM GX 262, DM OL 262 bearing (front/rear)				32212 F		TRB
Roda / Rueda / Wheel	•			30207 F		TRB
		•		32210 F		TRB
Mancal CM GX 262, DM OL 262 (dianteiro/traseiro) / Cojinete CM GX 262, DM OL 262 (delantero/trasero) / CM GX 262, DM OL 262 bearing (front/rear)				32212 F		TRB

Grade Aradora Intermediária GAI

Caixa de Redução / Caja de Reducción / Reduction Box

Mancal CM GX 262, DM OL 262 (dianteiro/traseiro) / Cojinete CM GX 262, DM OL 262 (delantero/trasero) / CM GX 262, DM OL 262 bearing (front/rear)				32212 F		TRB
--	--	--	--	----------------	--	-----

	OUT	IN		Fersa [®]	N° OEM	
---	-----	----	---	---------------------------	--------	---

MARCHESAN

Grade Aradora Mecânica GAM * GATCR

Caixa de Redução / Caja de Reducción / Reduction Box

Roda / Rueda / Wheel	●			30207 F		TRB
		●		32210 F		TRB
Mancal CM GX 225 (dianteiro/traseiro) / Cojinete CM GX 225 (delantero/trasero) / CM GX 225 bearing (front/rear)				30212 F		TRB
Mancal DM OL225 (dianteiro/traseiro) / Cojinete DM OL225 (delantero/traseiro) / DM OL225 bearing (front/rear)				3982 / 3920		TRB
Mancal MRO 243 / Cojinete MRO 243 / MRO 243 bearing				3984 / 3920		TRB

Grade Aradora Pesada com Pneus GAPCW

Caixa de Redução / Caja de Reducción / Reduction Box

Roda / Rueda / Wheel	●			2780 / 2720		TRB
		●		3780 / 3720		TRB
Seção de discos (dianteiro/traseiro) / Sección de discos (delantero/trasero) / Disc section (front/rear)				32216 F		TRB

Grade Aradora Pesada Controle Remoto GAPCR * GAPM

Caixa de Redução / Caja de Reducción / Reduction Box

Roda / Rueda / Wheel	●			32210 F		TRB
		●		32212 F		TRB
Seção de discos (dianteiro/traseiro) / Sección de discos (delantero/trasero) / Disc section (front/rear)				32216 F		TRB

Grade Aradora Pesada GAP * GAPC

Caixa de Redução / Caja de Reducción / Reduction Box

Seção de discos (dianteiro/traseiro) / Sección de discos (delantero/trasero) / Disc section (front/rear)				32216 F		TRB
--	--	--	--	---------	--	-----

Grade Aradora Super Pesada com Pneus GASPCW

Caixa de Redução / Caja de Reducción / Reduction Box

Seção de discos (dianteiro/traseiro) / Sección de discos (delantero/trasero) / Disc section (front/rear)				32218 F		TRB
Roda / Rueda / Wheel	●			2780 / 2720		TRB
		●		3780 / 3720		TRB

Grade Aradora Super Pesada Controle Remoto GASPCR * GAPM

Caixa de Redução / Caja de Reducción / Reduction Box

Roda / Rueda / Wheel	●			32210 F		TRB
----------------------	---	--	--	---------	--	-----

Caixa de Redução / Caja de Reducción / Reduction Box

Roda / Rueda / Wheel				32212 F		TRB
Seção de discos (dianteiro/traseiro) / Sección de discos (delantero/trasero) / Disc section (front/rear)				32218 F		TRB

Grade Hidráulica * Grade Niveladora * Grade Niveladora Flutuante * GNL

Caixa de Redução / Caja de Reducción / Reduction Box



Seção de discos (dianteiro/traseiro) / Sección de discos (delantero/trasero) / Disc section (front/rear)				30210 F		TRB
--	--	--	--	---------	--	-----



Grade Niveladora Controle Remoto GNCR * GND * GNDH * GNLCR * Grade Niveladora Flutuante Mecânica GNFM * GNM

Caixa de Redução / Caja de Reducción / Reduction Box

Roda / Rueda / Wheel	●			30207 F		TRB
		●		32210 F		TRB
Mancal CM GX 225 (dianteiro/traseiro) / Cojinete CM GX 225 (delantero/trasero) / CM GX 225 bearing (front/rear)				30210 F		TRB

		OUT	IN		Fersa®	Nº OEM	
MARCHESAN							
Guincho Agrícola Tatu Giratório GAT G * GATR							
Caixa de Redução / Caja de Reducción / Reduction Box							
Roda / Rueda / Wheel	•				30207 F		TRB
		•			32210 F		TRB
Perfurador de Solo PS							
Caixa de Redução / Caja de Reducción / Reduction Box							
Roda / Rueda / Wheel					3984 / 3920		TRB
		•			32210 F		TRB
Plantadeira Direta de Cereais & Pastagem PDCP							
Caixa de Redução / Caja de Reducción / Reduction Box							
Roda / Rueda / Wheel	•	•			30207 F		TRB
Roda compactadora (interno/externo) / Rueda compactadora (interno/externo) / Compactor wheel (outer/inner)					30204 F		TRB
Plantadeira Hidráulica Tatu PHT * PHT Suprema							
Caixa de Redução / Caja de Reducción / Reduction Box							
Roda externo / Rueda externo / Wheel (outboard)					LM 67048 / LM 67010		TRB
Roda / Rueda / Wheel		•			LM 48548 / LM 48510		TRB
Suporte do disco (interno/externo) / Soporte de disco (externo/interno) / Disc support (outer/inner)					30205 F		TRB
Suporte de disco duplo (interno/externo) / Soporte de disco doble (interno/externo) / Double disc support (inner/outer)					30204 F		TRB
Plantadeira Ultra FLEX * Ultra Flex Suprema							
Caixa de Redução / Caja de Reducción / Reduction Box							
Suporte do disco duplo (int. / ext.) / Soporte de disco doble (int / ext.) / Double disc support (inner/outer)					30204 F		TRB
Raspadeira Agrícola STA * STA 3 RT							
Caixa de Redução / Caja de Reducción / Reduction Box							
Roda externo / Rueda externo / Wheel (outboard)					3982 / 3920		TRB
Roçadeira RC 2 1300 * RC 2 1500 * RC 2 1700							
Caixa de Redução / Caja de Reducción / Reduction Box							
Eixo principal (dianteiro) / Eje principal (delantero) / Main shaft (front)					30207 F		TRB
Eixo principal (traseiro) / Eje principal (trasero) / Main shaft (rear)					32210 F		TRB
Pedestal suporte disco central / traseiro (interno) / Pedestal soporte disco central / trasero (interno) / Central and rear disc support (inner)					3982 / 3920		TRB
Roçadeira RC 2 2600 CL * LSL * RC 2 3100							
Caixa de Distribuição / Caja de Distribución / Distribution Box							
Eixo (dianteiro) / Eje (delantero) / Shaft (front)					368A / 362A		TRB
Eixo principal (dianteiro) / Eje principal (delantero) / Main shaft (front)					30207 F		TRB
Eixo principal (traseiro) / Eje principal (trasero) / Main shaft (rear)					32210 F		TRB
Roçadeira RC 2 4500 * Roçadeira de Arrasto RCA 3100 * RCA E 3400							
Caixa de Distribuição / Caja de Distribución / Distribution Box							
Roda guia (externo) / Rueda guía externo / Wheel guide (outer)					LM 67048 / LM 67010		TRB

	OUT	IN		Fersa®	Nº OEM	
VALTRA - VALMET						
Tratores 60 * 60 ID * 62 * 65 * 65 Cafeeiro * 68 * 68 Cafeeiro * 78 * 80 * M80 * 85 * 85ID * 86 * 86 ID * 88 * 88 ID						
Motor / Motor / Engine						
Alternador - acionamento / Alternador - accionamiento / Alternator - drive				6304 C3	LA1205	BB
Alternador (dianteiro) / Alternador (delantero) / Alternator (front)				6303 2RS / C3		BB
Alternador (traseiro) / Alternador (trasero) / Alternator (rear)				6201 2RS / C3		BB
Bomba hidráulica / Bomba hidráulica / Hydraulic pump				6008 Z		BB
Bomba injetora (dianteiro) / Bomba injetora (delantero) / Injection pump (front)				6203		BB
Bomba injetora (traseiro) / Bomba injetora (trasero) / Injection pump (rear)				30204 F		TRB
Dinamo (dianteiro) / Dinamo (delantero) / Dinamo (front)				6303 ZZ		BB
Dinamo (traseiro) / Dinamo (trasero) / Dinamo (rear)				6203 ZZ		BB
Embreagem / Embrague / Clutch						
Desengate / Desembrague / Clutch				F 15141	164481	TRBS
Eixo Traseiro / Eje Trasero / Rear Axle						
Diferencial - lateral coroa (traseiro) / Diferencial - lateral corona (trasero) / Differential - lateral crown (rear)				42368 / 42584	LA2226	TRB
Diferencial - pinhão / Diferencial - piñón / Differential - pinion				NU 310 FM / C3	LA3315	CRB
Eixo cônico - pinhão / Eje cónico - piñón / Tapered shaft - pinion				NU 310 FM / C3	LA3315	CRB
				HM 212047 / HM 212011		TRB
Pinhão / Piñón / Pinion				31308 F	LA5313	TRB
Eixo Dianteiro / Eje Delantero / Front Axle						
Roda / Rueda / Wheel				32208 F	LA5113	TRB
	•			30208 F	LA5103	TRB
		•		32210 F		TRB
Direção / Dirección / Steering						
Coluna / Columna / Column				6205 2RS		BB
Conjunto da Polia / Conjunto de Polea / Pulley Assembly						
Desengate / Desembrague / Clutch				6207 ZZ	LA1111	BB
Mancal / Cojinete / Bearing				6210	LA1115	BB
Ponta eixo acionamento / Punta eje accionamiento / Drive shaft tip acion.				6205 Z		BB
Câmbio / Cambio / Gearbox						
Coroa (dir./esq.) / Corona (der./izq.) / Crown (left/right)				42368 / 42584	LA2226	TRB
				32019 XF		TRB
Diferencial - pinhão / Diferencial - piñón / Differential - pinion				NU 310 FM / C3	LA3315	CRB
Eixo acionador (dianteiro) / Eje accionador (delantero) / Drive shaft (front)				6307	LA1211	BB
Eixo cônico - pinhão / Eje cónico - piñón / Tapered shaft - pinion				NU 310 FM / C3	LA3315	CRB
				31312 F	LA5318	TRB
Eixo de saída / Eje de salida / Output shaft				3982 / 3920		TRB
Eixo primário (dianteiro) / Eje primario (delantero) / Primary shaft (front)				6306	LA1209	BB

	OUT	IN		Fersa [®]	N° OEM	
---	-----	----	---	---------------------------	--------	---

VALTRA - VALMET

Tratores 60 * 60 ID * 62 * 65 * 65 Cafeeiro * 68 * 68 Cafeeiro * 78 * 80 * M80 * 85 * 85ID * 86 * 86 ID * 88 * 88 ID

Motor / Motor / Engine

Eixo primário (traseiro) / Eje primario (trasero) / Primary shaft (rear)				30208 F	LA5013	TRB
Eixo secundário (traseiro) / Eje secundario (trasero) / Secondary shaft (rear)			Cafeeiro	6307 C3	LA12111	BB
Pinhão / Piñón / Pinion				31308 F	LA5313	TRB
Ponta eixo acionamento / Punta eje accionamiento / Drive shaft tip				6205 Z		BB
Embreagem / Embrague / Clutch						
Desengate / Desembrague / Clutch				6207 ZZ		BB
Ponta eixo acionamento / Punta eje accionamiento / Drive shaft tip acion.				6304 2RS	LA1291	BB
Ponta eixo acionamento / Punta eje accionamiento / Drive shaft tip acion. - embr. dupla				6304 ZZ		BB
Ponta eixo acionamento / Punta eje accionamiento / Drive shaft tip acion. - embr. simples				6205 Z		BB

Tratores 110 ID * 110ID II * 118 * 118 (4 x 4) * 128 * 128 (4 x 4)

Motor / Motor / Engine

Alternador - acionamento / Alternador - accionamiento / Alternator - drive				6304		BB
Alternador (dianteiro) / Alternador (delantero) / Alternator (front)				6303 2RS / C3		BB
Alternador (traseiro) / Alternador (trasero) / Alternator (rear)				6201 2RS / C3		BB
Bomba d'água / Bomba de agua / Water pump				30302 F		TRB
Bomba injetora (dianteiro) / Bomba inyectora (delantero) / Injection pump (front)				6203		BB
Dínamo (dianteiro) / Dinamo (delantero) / Dinamo (front)				6303 ZZ		BB
Dínamo (traseiro) / Dinamo (trasero) / Dinamo (rear)				6203 ZZ		BB
Ventilador / Ventilador / Fan				30302 F		TRB

Eixo Dianteiro / Eje Delantero / Front Axle

Roda / Rueda / Wheel				32208 F	LA5113	TRB
				32210 F		TRB
	•		118 E 118 4 x 4	LM 48548 / LM 48510		TRB
	•			30208 F	LA5103	TRB
		•	118 E 118 4 x 4	LM 603049 / LM 603011		TRB
		•		32210 F		TRB

Eixo Traseiro / Eje Trasero / Rear Axle

Diferencial - lateral coroa (traseiro) / Diferencial - lateral corona (trasero) / Differential - lateral crown (rear)				42368 / 42584	LA2226	TRB
Diferencial - pinhão / Diferencial - piñón / Differential - pinion				NU 310 FM / C3	LA3315	CRB
Pinhão / Piñón / Pinion				31308 F	LA5313	TRB
				30312 F	LA5218	TRB
Transmissão / Transmisión / Transmission			4 x 4	30312 F	LA5218	TRB
Transmissão / Transmisión / Transmission				HM 218248 / HM 218210	291060/ 1524625	TRB
Ponta eixo acionamento / Punta eje accionamiento / Drive shaft tip acion. - embr. dupla				6304 ZZ		BB

	OUT	IN		Fersa®	Nº OEM	
---	-----	----	---	---------------	--------	---

VALTRA - VALMET

Tratores 110 ID * 110ID II * 118 * 118 (4 x 4) * 128 * 128 (4 x 4)

Ponta eixo acionamento / Punta eje accionamiento / Drive shaft tip acion.				6205 Z		BB
---	--	--	--	---------------	--	----

Conjunto da Polia / Conjunto de Polea / Pulley Assembly

Mancal / Cojinete / Bearing				6210	LA1115	BB
-----------------------------	--	--	--	-------------	--------	----

Câmbio / Cambio / Gearbox

				30312 F	164481	TRBS
--	--	--	--	----------------	--------	------

Blindagem (dir./esq.) / Escudo (der./izq.) / Shield (left/right)				HM 218248 / HM 218210	291060/ 1524625	TRB
--	--	--	--	------------------------------	-----------------	-----

Desengate / Desembrague / Clutch				F 15141	164481	TRBS
----------------------------------	--	--	--	----------------	--------	------

Coroa (dir./esq.) / Corona (der./izq.) / Crown (left/right)				32019 XF		TRB
---	--	--	--	-----------------	--	-----

Eixo cônico - pinhão / Eje cónico - piñón / Tapered shaft - pinion				NU 310 FM / C3	LA3315	CRB
--	--	--	--	-----------------------	--------	-----

				31312 F	LA5318	TRB
--	--	--	--	----------------	--------	-----

Eixo primário (dianteiro) / Eje primario (delantero) / Primary shaft (front)				6306	LA1209	BB
--	--	--	--	-------------	--------	----

Eixo primário (traseiro) / Eje primario (trasero) / Primary shaft (rear)				30208 F	LA5013	TRB
--	--	--	--	----------------	--------	-----

Eixo secundário (traseiro) / Eje secundario (trasero) / Secondary shaft (rear)			Cafeeiro	6307 C3	LA12111	BB
--	--	--	----------	----------------	---------	----

				6309		BB
--	--	--	--	-------------	--	----

				6205 Z		BB
--	--	--	--	---------------	--	----

Ponta eixo acionamento / Punta eje accionamiento / Drive shaft tip acion.				6205 2RS	LA11074	BB
---	--	--	--	-----------------	---------	----

				6304 2RS	LA1291	BB
--	--	--	--	-----------------	--------	----

Super - Redução / Super - Reducción / Super - Reduction

				6210	LA1115	BB
--	--	--	--	-------------	--------	----

				6009		BB
--	--	--	--	-------------	--	----

Tomada de Potência / Toma de Potencia / Power Take-off

Eixo da Tomada de Potência (dianteiro) / Toma de Potencia (delantero) / Power Take-off - (front)				30208 F	LA5013	TRB
--	--	--	--	----------------	--------	-----

				6308	LA1213	BB
--	--	--	--	-------------	--------	----

Eixo da Tomada de Potência / Toma de Potencia / Power Take-off - traseiro				6210	LA1115	BB
---	--	--	--	-------------	--------	----

Eixo estriado - na carcaça / Eje estriado - carcasa / Spline shaft - housing				32208 F	LA5113	TRB
--	--	--	--	----------------	--------	-----

				6011	LA1016	BB
--	--	--	--	-------------	--------	----

				6307		BB
--	--	--	--	-------------	--	----

Tratores 870 CN/CK

Tomada de Potência / Toma de Potencia / Power Take-off

Eixo da Tomada de Potência / Toma de Potencia / Power Take-off - dianteiro				6308	LA1213	BB
--	--	--	--	-------------	--------	----

Eixo da Tomada de Potência / Toma de Potencia / Power Take-off - traseiro				6210	LA1115	BB
---	--	--	--	-------------	--------	----

Eixo estriado - na carcaça / Eje estriado - carcasa / Spline shaft - housing				6011	LA1016	BB
--	--	--	--	-------------	--------	----

--	--	--	--	--	--	--

Eixo Dianteiro / Eje Delantero / Front Axle

Roda / Rueda / Wheel		•		32210 F	LA5115	TRB
----------------------	--	---	--	----------------	--------	-----

Eixo Traseiro / Eje Trasero / Rear Axle

				30312 F	LA5218	TRB
--	--	--	--	----------------	--------	-----

Transmissão / Transmisión / Transmission				30312 F	LA5218	TRB
--	--	--	--	----------------	--------	-----

Transmissão / Transmisión / Transmission			4 x 4	HM 218248 / HM 218210	291060/ 1524625	TRB
--	--	--	-------	------------------------------	-----------------	-----

	OUT	IN		Fersa [®]	N° OEM	
---	-----	----	---	---------------------------	--------	---

VALTRA - VALMET

Tratores 870 CN * CK

Câmbio / Cambio / Gearbox

Blindagem (dir.) / Escudo (der.) / Shield (right)				HM 218248 / HM 218210	291060/ 1524625	TRB
Blindagem / Escudo / Shield				30312 F		TRB
Coroa (dir./esq.) / Corona (der./izq.) / Crown (left/right)				42381 / 42584	265150	TRB
Eixo acionador (traseiro) / Eje accionador (trasero) / Drive shaft (rear)				6207	LA1111	BB

Motor / Motor / Engine

Alternador (dianteiro) / Alternador (delantero) / Alternator (front)				6303 2RS / C3		BB
Alternador (traseiro) / Alternador (trasero) / Alternator (rear)				6201 2RS / C3		BB

Embreagem / Embrague / Clutch

Mancal / Cojinete / Bearing				6014 2RS / C3	LA1986	BB
Ponta eixo acionamento / Punta eje accionamiento / Drive shaft tip acion.				6304 2RS	LA1291	BB
				6205 2RS	LA11074	BB

Super - Redução / Super - Reducción / Super - Reduction

				6210	LA1115	BB
--	--	--	--	-------------	--------	----

Tração Dianteira / Tracción Delantera / Front Traction

		•	4 x 4	42381 / 42584	265150	TRB
--	--	---	-------	----------------------	--------	-----

Tratores 360 D * 600 D * 621 ID

Câmbio / Cambio / Gearbox

Eixo acionador (dianteiro) / Eje accionador (delantero) / Drive shaft (front)				6208 ZZ		BB
				6307	LA1211	BB
Eixo primário (dianteiro) / Eje primario (delantero) / Primary shaft (front)				6306	LA1209	BB

Embreagem / Embrague / Clutch

Desengate / Desembrague / Clutch				6207 ZZ	LA1111	BB
Ponta eixo acionamento / Punta eje accionamiento / Drive shaft tip acion.				6205 Z		BB

Eixo Dianteiro / Eje Delantero / Front Axle

				30208 F		TRB
Roda / Rueda / Wheel	•			30208 F		TRB
		•		32210 F	LA5115	TRB

Motor / Motor / Engine

Bomba d'água / Bomba de agua / Water pump				6303		BB
Bomba hidráulica / Bomba hidráulica / Hydraulic pump				6008 Z		BB
Dínamo (dianteiro) / Dinamo (delantero) / Dinamo (front)				6202 ZZ		BB
				6303 ZZ		BB
				6201 ZZ		BB
Dínamo (traseiro) / Dinamo (trasero) / Dinamo (rear)				6202 ZZ		BB
				6203 ZZ		BB
Virabrequim / Cigüeñal / Crankshaft				6304		BB

	OUT	IN		Fersa®	N° OEM	
---	-----	----	---	---------------	--------	---

VALTRA - VALMET

Tratores 360 D * 600 D * 621 ID

Tomada de Potência / Toma de Potencia / Power Take-off

				6206 Z		BB
--	--	--	--	---------------	--	----

Direção / Dirección / Steering

Coluna / Columna / Column				6205 2RS		BB
---------------------------	--	--	--	-----------------	--	----

Tratores 685 * 685C 4 x 4 * 785 * 785C 4 x 4 * 880 Cafeeiro * 880 4 x 4 * 885 * 980 4 x 4 * 985 * 985F * 1180 * 1184

Motor / Motor / Engine

Alternador (dianteiro) / Alternador (delantero) / Alternator (front)				6303 2RS / C3		BB
Alternador (traseiro) / Alternador (trasero) / Alternator (rear)				6201 2RS / C3		BB
Bomba injetora (dianteiro) / Bomba inyectora (delantero) / Injection pump (front)				30203 F		TRB
Bomba injetora (traseiro) / Bomba inyectora (trasero) / Injection pump (rear)				30204 F		TRB

Câmbio / Cambio / Gearbox

Blindagem (esq.) / Escudo (izq.) / Shield (left)				HM 218248 / HM 218210	291060/ 1524625	TRB
Diferencial - lateral coroa (traseiro) / Diferencial - lateral corona (trasero) / Differential - lateral crown (rear)			Cafeeiro	42368 / 42584	LA2226	TRB
Eixo primário (traseiro) / Eje primario (trasero) / Primary shaft (rear)				30208 F	LA5013	TRB
Eixo acionador (traseiro) / Eje accionador (trasero) / Drive shaft (rear)				6207	LA1111	BB
Pinhão / Piñón / Pinion				31308 F	LA5313	TRB

Diferencial / Diferencial / Differential

				F 15165	0735370232 / 0735370145	TRBS
--	--	--	--	----------------	-------------------------	------

Direção / Dirección / Steering

Volante / Volante / Steering wheel			Fruteiro	6205 Z		BB
------------------------------------	--	--	----------	---------------	--	----

Eixo Cardan / Eje Cardan / Cardan Shaft

			4x4	6207		BB
--	--	--	-----	-------------	--	----

Eixo Traseiro / Eje Trasero / Rear Axle

Coroa (dir./esq.) / Corona (der./izq.) / Crown (left/right)				32019 XF		TRB
Eixo cônico - pinhão / Eje cónico - piñón / Tapered shaft - pinion				31312 F	LA5318	TRB
Transmissão / Transmisión / Transmission				33287 / 33462	LA5987/LA5988	TRB

Tração Dianteira / Tracción Delantera / Front Traction

Diferencial (dir./esq.)				LM 501349 / LM 501310		TRB
Pinhão (dianteiro) / Piñón (delantero) / Pinion (front)				M 802048 / M 802011		TRB
				31308 F		TRB
				32208 F	LA5113	TRB
Roda / Rueda / Wheel	●			32210 F	LA5115	TRB
		●		30208 F	LA5103	TRB

Embreagem / Embrague / Clutch

Ponta eixo acionamento / Punta eje accionamiento / Drive shaft tip acion.				6304 2RS	LA1291	BB
				6205 2RS	LA11074	BB
Desengate / Desembrague / Clutch				F 15141	164481	TRBS

	OUT	IN		Fersa [®]	N° OEM	
---	-----	----	---	---------------------------	--------	---

VALTRA - VALMET

Tratores 685 * 685C 4 x 4 * 785 * 785C 4 x 4 * 880 Cafeeiro * 880 4 x 4 * 885 * 980 4 x 4 * 985 * 985F * 1180 * 1184

Tomada de Potência / Toma de Potencia / Power Take-off

Eixo da Tomada de Potência / Toma de Potencia / Power Take-off - dianteiro				30208 F	LA5013	TRB
Eixo da Tomada de Potência / Toma de Potencia / Power Take-off - traseiro				6210	LA1115	BB
Eixo estriado - na carcaça / Eje estriado - carcasa / Spline shaft - housing				32208 F	LA5113	TRB
Eixo estriado / Eje estriado / Spline shaft				6210	LA1115	BB
			4 x 4	6307		BB
				30207 F		TRB
				6304		BB
				6010		BB

Redução / Reducción / Reduction

				6207 ZZ		BB
--	--	--	--	----------------	--	----

Conjunto da Polia / Conjunto de Polea / Pulley Assembly

Mancal / Cojinete / Bearing				6210	LA1115	BB
-----------------------------	--	--	--	-------------	--------	----

Tratores 1280 * 1284 * 1580 * 1780 * 1780 4x4 * 1380 * 1680 * 1880 * 118 * 128 * 138 * 148 * 148 4x4

Embreagem / Embrague / Clutch

Desengate / Desembrague / Clutch				F 15141	164481	TRBS
----------------------------------	--	--	--	----------------	--------	------

Eixo Traseiro / Eje Trasero / Rear Axle

Coroa (dir./esq.) / Corona (der./izq.) / Crown (left/right)				42381 / 42584	265150	TRB
			4 x 4	30312 F	LA5218	TRB
Transmissão / Transmisión / Transmission				30312 F	LA5218	TRB
			4 x 4	HM 218248 / HM 218210	291060/ 1524625	TRB
			1780 4 x 4	33018 F		TRB

Motor / Motor / Engine

Alternador (dianteiro) / Alternador (delantero) / Alternator (front)				6303 2RS / C3		BB
Alternador (traseiro) / Alternador (trasero) / Alternator (rear)				6201 2RS / C3		BB

Tração Dianteira / Tracción Delantera / Front Traction

Roda / Rueda / Wheel	●			32210 F		TRB
		●		42381 / 42584	265150	TRB

Câmbio / Cambio / Gearbox

Blindagem (dir.) / Escudo (der.) / Shield (right)				HM 218248 / HM 218210	291060/ 1524625	TRB
Eixo acionador (traseiro) / Eje accionador (trasero) / Drive shaft (rear)				6207	LA1111	BB
Eixo primário (traseiro) / Eje primario (trasero) / Primary shaft (rear)				NJ 309 FM / C3	LA3976	CRB
				NUP 309 FM		CRB
Mancal / Cojinete / Bearing				6014 2RS / C3	LA1986	BB
Ponta eixo acionamento / Punta eje accionamiento / Drive shaft tip acion.				6304 2RS	LA1291	BB
				6205 2RS	LA11074	BB

Tomada de Potência / Toma de Potencia / Power Take-off

				6309		BB
				NUP 309 FM		CRB

	OUT	IN		Fersa®	N° OEM	
---	-----	----	---	---------------	--------	---

VALTRA - VALMET

Tratores 1280 * 1284 * 1580 * 1780 * 1780 4x4 * 1380 * 1680 * 1880 * 118 * 128 * 138 * 148 * 148 4x4

Tomada de Potência / Toma de Potencia / Power Take-off

Eixo estriado - na carcaça / Eje estriado - carcasa / Spline shaft - housing				6011	LA1016	BB
Eixo da Tomada de Potência / Toma de Potencia / Power Take-off - dianteiro				6308	LA1213	BB
Eixo da Tomada de Potência / Toma de Potencia / Power Take-off - traseiro				6210	LA1115	BB

Redução / Reducción / Reduction

				6210	LA1115	BB
--	--	--	--	-------------	--------	----

Empilhadeira - 7000

Câmbio / Cambio / Gearbox

Blindagem (dir.) / Escudo (der.) / Shield (right) e (esq.)				HM 218248 / HM 218210	291060/ 1524625	TRB
--	--	--	--	------------------------------	-----------------	-----

Todos

Direção / Dirección / Steering

Coluna / Column / Column				6304	LA1205	BB
--------------------------	--	--	--	-------------	--------	----



06

Bearings for Bus Applications

Rolamentos para Aplicações de Ônibus
Rodamientos para Aplicaciones de Autobús







DINA

300 Serie

Eixo Traseiro / Eje Trasero / Rear Axle

Diferencial - flecha de entrada / Diferencial - flecha de entrada / Differential - input shaft				3775 / 3720		TRB
Diferencial - (dir. / esq.) / Diferencial - (der. / izq.) / Differential (right / left)				47890 / 47820	181608 / 590762	TRB
Diferencial - pinhão cabeça / Diferencial - piñón cabeça / Differential - pinion head				H 715343 / H 715311	500588901	TRB
Diferencial - pinhão cola / Diferencial - piñón cola / Differential - rear pinion				H 715334 / H 715311	500587901	TRB

Eixo Dianteiro / Eje Delantero / Front Axle

Roda / Rueda / Wheel	•			3782 / 3720	807949	TRB
		•		HM 212047 / HM 212011	C4TA1215B	TRB

Eixo Traseiro / Eje Trasero / Rear Axle

Roda / Rueda / Wheel	•			580 / 572	39811405	TRB
		•		594 A / 592 A	183704	TRB

434 17570 Shuttle Bus

Eixo Traseiro / Eje Trasero / Rear Axle

Diferencial - eixo de saída / Diferencial - eje de salida / Differential - output shaft				LM 104949 / LM 104910		TRB
Diferencial (dir.) / Diferencial (der.) / Differential (right)				34306 / 34478		TRB
Diferencial - (dir. / esq.) / Diferencial - (der. / izq.) / Differential (right / left)			Rockwell 23,000 lb.	594 A / 592 A	183704	TRB
			Rockwell 23,000 lb.	32021 XF		TRB
Diferencial - pinhão (cabeza - cola) / Diferencial - piñón (cabeza / cola) / Differential - pinion (head / rear)			Rockwell 23,000 lb.	9278 / 9220		TRB
			Rockwell 23,000 lb.	HM 813849 / HM813810		TRB

Eixo Dianteiro / Eje Delantero / Front Axle

Roda / Rueda / Wheel	•			25877 / 25820		TRB
		•		JM 207049 A / JM 207010		TRB



Eixo Traseiro / Eje Trasero / Rear Axle

Roda / Rueda / Wheel	•		Eaton RS12110, 12,000lb.	39590 / 39520	1240A / 2986843	TRB
		•	Eaton RS12110, 12,000lb.	47686 / 47620		TRB
Eixo auxiliar (traseiro) / Eje auxiliar (trasero) / Auxiliar axle (rear)	•			3782 / 3720	807949	TRB
		•		HM 212049 / HM 212011		TRB

500 Serie

Eixo Traseiro / Eje Trasero / Rear Axle

Diferencial (dir.) / Diferencial (der.) / Differential (right)			Eaton 17,500 lb.	33275 / 33472		TRB
			Eaton 17,500 lb.	3994 / 3920	06.32499.0145	TRB
			Eaton 17,500 / 18,500	495 A / 493		TRB
			Eaton 18,500 lb.	497 / 493	81.93420.0195	TRB
Diferencial (esq.) / Diferencial (izq.) / Differential (left)			Eaton 17,500 lb.	42381 / 42584		TRB
			Eaton 17,500 lb.	498 / 493		TRB
			Eaton 17,500 / 18,500 lb.	567 / 563	354821	TRB
			Eaton 18,500 lb.	56425 / 56650		TRB
Diferencial - pinhão (cabeza - cola) / Diferencial - piñón (cabeza / cola) / Differential - pinion (head / rear)			Eaton 17,500 lb.	HM 903249 / HM 903210	931482	TRB
			Eaton 18,500 lb.	55200 C / 55437		TRB

	OUT	IN		Fersa®	Nº OEM	
---	-----	----	---	---------------	--------	---

DINA

500 Serie

Eixo Dianteiro / Eje Delantero / Front Axle

Roda / Rueda / Wheel	•			3782 / 3720	807949	TRB
		•		HM 212049 / HM 212011		TRB
Eixo Traseiro / Eje Trasero / Rear Axle						
Roda / Rueda / Wheel	•			594 A / 592 A	183704	TRB
		•		580 / 572	39811405	TRB

Citus 11000 * 9500

Eixo Dianteiro / Eje Delantero / Front Axle

Roda / Rueda / Wheel	•			25877 / 25820		TRB
		•		JM 207049 / JM 207010		TRB
	•		...91	3782 / 3720	807949	TRB
		•	...91	HM 212047 / HM 212011	C4TA1215B	TRB
	•		92...94	3782 / 3720	807949	TRB
		•	92...94	HM 212049 / HM 212011		TRB

Eixo Traseiro / Eje Trasero / Rear Axle

Roda / Rueda / Wheel	•			580 / 572	39811405	TRB
		•		594 A / 592 A	183704	TRB

D-Avante Plus * D-Dorado

Eixo Traseiro / Eje Trasero / Rear Axle

Diferencial - eixo de entrada (dianteiro) / Diferencial - eje de entrada (delantero) / Differential - input shaft (front)			Meritor RT40-145 * Rockwell	JM 511946 / JM 511910		TRB
Diferencial - eixo de entrada (traseiro) / Diferencial - eje de entrada (trasero) / Differential - input shaft (rear)			Meritor RT40-145 * Rockwell	JLM 710949 / JLM 710910		TRB
Diferencial - eixo de saída / Diferencial - eje de salida / Differential - output shaft			Meritor RT40-145 * Rockwell	LM 104949 / LM 104910		TRB
Diferencial - (dir. / esq.) / Diferencial - (der. / izq.) / Differential (right / left)			Meritor RT40-145 * Rockwell	JM 716649 / JM 716610		TRB
Diferencial - pinhão cabeça / Diferencial - piñón cabeza / Differential - pinion head			Meritor RT40-145 * Rockwell	H 715334 / H 715311	500587901	TRB
Diferencial - pinhão cola / Diferencial - piñón cola / Differential - rear pinion			Meritor RT40-145 * Rockwell	72212 C / 72487		TRB

Direção / Dirección / Steering

Perno de direção / Perno de dirección / Pintle direction				T 182	DIHA 3123 A2A	TRBT
--	--	--	--	--------------	---------------	------

Eixo Dianteiro / Eje Delantero / Front Axle

Roda / Rueda / Wheel	•		Dirona R-140	3782 / 3720	807949	TRB
		•	Dirona R-140	HM 212047 / HM 212011	C4TA1215B	TRB
	•			3782 / 3720	807949	TRB
		•		HM 212049 / HM 212011		TRB

Eixo Traseiro / Eje Trasero / Rear Axle

Roda / Rueda / Wheel	•			580 / 572	39811405	TRB
		•		594 A / 592 A	183704	TRB

DPC311774 * DPT231770 * DPC311970 * DPT311770 * DPT351970 * DPT352171 * DPT352172 * DPX281770

Direção / Dirección / Steering

Perno de direção / Perno de dirección / Pintle direction				T 182	DIHA 3123 A2A	TRBT
--	--	--	--	--------------	---------------	------

Eixo Dianteiro / Eje Delantero / Front Axle

Roda / Rueda / Wheel	•			3782 / 3720	807949	TRB
		•		HM 212049 / HM 212011		TRB

	OUT	IN		Fersa®	N° OEM	
---	-----	----	---	---------------	--------	---

DINA

DPC311774 * DPT231770 * DPC311970 * DPT311770 * DPT351970 * DPT352171 * DPT352172 * DPX281770

Eixo Traseiro / Eje Trasero / Rear Axle

Roda / Rueda / Wheel	•			580 / 572	39811405	TRB
		•		594 A / 592 A	183704	TRB

DPX311970

Eixo Dianteiro / Eje Delantero / Front Axle

Roda / Rueda / Wheel	•			3782 / 3720	807949	TRB
		•		HM 212049 / HM 212011		TRB

Eixo Traseiro / Eje Trasero / Rear Axle

Roda / Rueda / Wheel	•			39590 / 39520	1240A / 2986843	TRB
		•		47686 / 47620		TRB

F11 * F12 * F14

Eixo Traseiro / Eje Trasero / Rear Axle

Diferencial - eixo de entrada / Diferencial - eje de entrada / Differential - input shaft				JH 211749 / JH 211710	183844	TRB
Diferencial - eixo de saída / Diferencial - eje de salida / Differential - output shaft				LM 104949 / LM 104910		TRB
Diferencial - interdiferencial / Diferencial - interdiferencial / Differential - interdifferential				JLM 714149 / JLM 714110	183345	TRB
Diferencial - (dir. / esq.) / Diferencial - (der. / izq.) / Differential (right / left)				47890 / 47820	181608 / 590762	TRB
Diferencial - pinhão cabeça / Diferencial - piñón cabeza / Differential - pinion head				H 715343 / H 715311	500588901	TRB
Diferencial - pinhão cola / Diferencial - piñón cola / Differential - rear pinion				65237 / 65500	32230	TRB

Eixo Dianteiro / Eje Delantero / Front Axle

Roda / Rueda / Wheel	•			3782 / 3720	807949	TRB
		•		HM 212049 / HM 212011		TRB

Eixo Traseiro / Eje Trasero / Rear Axle

Roda / Rueda / Wheel	•			580 / 572	39811405	TRB
		•		594 A / 592 A	183704	TRB

Marco Polo

Eixo Traseiro / Eje Trasero / Rear Axle

Diferencial - eixo de entrada / Diferencial - eje de entrada / Differential - input shaft				JH 211749 / JH 211710	183844	TRB
Diferencial - eixo de saída / Diferencial - eje de salida / Differential - output shaft				LM 104949 / LM 104910		TRB
Diferencial - interdiferencial / Diferencial - interdiferencial / Differential - interdifferential				JLM 714149 / JLM 714410	183345	TRB
Diferencial - (dir. / esq.) / Diferencial - (der. / izq.) / Differential (right / left)				47890 / 47820	181608 / 590762	TRB
Diferencial - pinhão cabeça / Diferencial - piñón cabeza / Differential - pinion head				H 715343 / H 715311	500588901	TRB
Diferencial - pinhão cola / Diferencial - piñón cola / Differential - rear pinion				65237 / 65500	32230	TRB

Eixo Dianteiro / Eje Delantero / Front Axle

Roda / Rueda / Wheel	•			3782 / 3720	807949	TRB
		•		HM 212049 / HM 212011		TRB

Eixo Traseiro / Eje Trasero / Rear Axle

Roda / Rueda / Wheel	•			580 / 572	39811405	TRB
		•		594 A / 592 A	183704	TRB

	OUT	IN		Fersa ®	N° OEM	
---	-----	----	---	----------------	--------	---

DINA

Paradiso * Quadro

Direção / Dirección / Steering

Perno de direção / Perno de dirección / Pintle direction				T 182	DIHA 3123 A2A	TRBT
--	--	--	--	--------------	---------------	------

Eixo Dianteiro / Eje Delantero / Front Axle

Roda / Rueda / Wheel	•		...91	3782 / 3720	807949	TRB
		•	...91	HM 212047 / HM 212011	C4TA1215B	TRB
	•			3782 / 3720	807949	TRB
		•		HM 212049 / HM 212011		TRB

Eixo Traseiro / Eje Trasero / Rear Axle

Roda / Rueda / Wheel	•			580 / 572	39811405	TRB
		•		594 A / 592 A	183704	TRB

Viaggio

Eixo Traseiro / Eje Trasero / Rear Axle

Diferencial - eixo de entrada / Diferencial - eje de entrada / Differential - input shaft			Rockwell SSHD 46,000 lb.	JH 211749 / JH 211710	183844	TRB
Diferencial - eixo de entrada (dianteiro) / Diferencial - eje de entrada (delantero) / Differential - input shaft (front)			Rockwell 40,000 lb.	JM 511946 / JM 511910		TRB
Diferencial - eixo de entrada (traseiro) / Diferencial - eje de entrada (trasero) / Differential - input shaft (rear)			Rockwell 40,000 lb. RT40-145	JLM 710949 / JLM 710910		TRB
Diferencial - eixo de saída / Diferencial - eje de salida / Differential - output shaft			Rockwell 40,000 lb. RT40-145	LM 104949 / LM 104910		TRB
Diferencial - interdiferencial / Diferencial - interdiferencial / Differential - interdifferential			Rockwell SSHD 46,000 lb.	JLM 714149 / JLM 714110	183345	TRB
Diferencial - (dir. / esq.) / Diferencial - (der. / izq.) / Differential (right / left)			Rockwell 40,000 lb.	JM 716649 / JM 716610		TRB
			Rockwell SSHD 46,000	47890 / 47820	181608 / 590762	TRB
Diferencial - pinhão cabeça / Diferencial - piñón cabeza / Differential - pinion head			Rockwell 40,000 lb. RT40-145	H 715334 / H 715311	500587901	TRB
			Rockwell SSHD 46,000 lb.	H 715343 / H 715311	500588901	TRB
Diferencial - pinhão cola / Diferencial - piñón cola / Differential - rear pinion			Rockwell RT-40-145 40,000 lb.	72212 C / 72487		TRB
			Rockwell SSHD 46,000 lb.	65237 / 65500	32230	TRB

Eixo Dianteiro / Eje Delantero / Front Axle

Roda / Rueda / Wheel	•			3782 / 3720	807949	TRB
		•		HM 212049 / HM 212011		TRB

Eixo Traseiro / Eje Trasero / Rear Axle

Roda / Rueda / Wheel	•			580 / 572	39811405	TRB
		•		594 A / 592 A	183704	TRB



	OUT	IN		Fersa®	N° OEM	
---	-----	----	---	---------------	--------	---

FORD

B-800

Eixo Traseiro / Eje Trasero / Rear Axle

Diferencial (dir.) / Diferencial (der.) / Differential (right)				497 / 493	620244	TRB
Diferencial (esq.) / Diferencial (izq.) / Differential (left)				56425 / 56650		TRB
Diferencial - pinhão cabeça / Diferencial - piñón cabeza / Differential - pinion head				72200 C / 72487		TRB
Diferencial - pinhão cola / Diferencial - piñón cola / Differential - rear pinion				55200 C / 55437		TRB

Eixo Dianteiro / Eje Delantero / Front Axle

Roda / Rueda / Wheel	•			3782 / 3720	807949	TRB
		•		HM 212049 / HM 212011		TRB

Eixo Traseiro / Eje Trasero / Rear Axle

Roda / Rueda / Wheel	•			580 / 572		TRB
		•		594 A / 592 A	183704	TRB

INTERNATIONAL

3000 RE

Caixa de Mudanças / Caja de Cambios / Gearbox

			Fuller FS5406	25590 / 25522		TRB
			Fuller FS5406	39590 / 39520		TRB
			Fuller FS5406	31594 / 31520		TRB
			Fuller FS5406	3782 / 3720	807949	TRB

Eixo Dianteiro / Eje Delantero / Front Axle

Roda / Rueda / Wheel	•			3782 / 3720	807949	TRB
		•		HM 212049 / HM 212011		TRB

Eixo Traseiro / Eje Trasero / Rear Axle

Roda / Rueda / Wheel	•			580 / 572		TRB
		•		594 A / 592 A	0039811405 / 183704	TRB

4700 FBC * 4700 FE (4X2) * 4700 SCD * 4700 SCD (444 * 466)



Eixo Dianteiro / Eje Delantero / Front Axle

Roda / Rueda / Wheel	•			3782 / 3720	807949	TRB
		•		HM 212049 / HM 212011		TRB

Eixo Traseiro / Eje Trasero / Rear Axle

Roda / Rueda / Wheel	•			580 / 572		TRB
		•		594 A / 592 A	0039811405 / 183704	TRB



	OUT	IN		Fersa®	N° OEM	
---	-----	----	---	---------------	--------	---

MASA

502 UX

Eixo Traseiro / Eje Trasero / Rear Axle

Diferencial - (dir. / esq.) / Diferencial - (der. / izq.) / Differential (right / left)				47890 / 47820		TRB
Diferencial - nariz pinhão / Diferencial - nariz piñón / Differential - pinion				F 19034		CRBS
Diferencial - pinhão cabeça / Diferencial - piñón cabeça / Differential - pinion head				H 715343 / H 715311	500588901	TRB
Diferencial - pinhão cola / Diferencial - piñón cola / Differential - rear pinion				H 715334 / H 715311	500587901	TRB

Direção / Dirección / Steering

Perno de direção / Perno de dirección / Pintle direction				T 182	DIHA 3123 A2A	TRBT
--	--	--	--	--------------	---------------	------

Eixo Dianteiro / Eje Delantero / Front Axle

Roda / Rueda / Wheel	•		12,000 lb.	3782 / 3720	807949	TRB
		•	12,000 lb.	HM 212047 / HM 212011	C4TA1215B	TRB
	•		13,200 lb.	3782 / 3720	807949	TRB
		•	13,200 lb.	HM 212049 / HM 212011		TRB

Eixo Traseiro / Eje Trasero / Rear Axle

Roda / Rueda / Wheel	•		R140	580 / 572		TRB
		•	R140	594 A / 592 A		TRB

Jaguar * Condor * Géminis * Halcón * Strada * Premier 2030F

Caixa de Mudanças / Caja de Cambios / Gearbox

			ZF 105	F 15047		STB
			ZF 105	NUP 314 FMNR / C3		CRB

Eixo Traseiro / Eje Trasero / Rear Axle

Diferencial - (dir. / esq.) / Diferencial - (der. / izq.) / Differential (right / left)				47890 / 47820		TRB
Diferencial - nariz pinhão / Diferencial - nariz piñón / Differential - pinion				F 19034		CRBS
Diferencial - pinhão cabeça / Diferencial - piñón cabeça / Differential - pinion head				H 715343 / H 715311	500588901	TRB
Diferencial - pinhão cola / Diferencial - piñón cola / Differential - rear pinion				H 715334 / H 715311	500587901	TRB

Direção / Dirección / Steering

Perno de direção / Perno de dirección / Pintle direction				T 182	DIHA 3123 A2A	TRBT
--	--	--	--	--------------	---------------	------

Eixo Dianteiro / Eje Delantero / Front Axle

Roda / Rueda / Wheel	•		12,000 lb.	3782 / 3720	807949	TRB
		•	12,000 lb.	HM 212047 / HM 212011	C4TA1215B	TRB
	•		13,200 lb.	3782 / 3720	807949	TRB
		•	13,200 lb.	HM 212049 / H 212011		TRB

Eixo Traseiro / Eje Trasero / Rear Axle

Roda / Rueda / Wheel	•		23,000 lb.	580 / 572		TRB
		•	23,000 lb.	594 A / 592 A		TRB

S 5000 * S 5002 * S 2030

Eixo Traseiro / Eje Trasero / Rear Axle

Diferencial - (dir. / esq.) / Diferencial - (der. / izq.) / Differential (right / left)				47890 / 47820		TRB
Diferencial - nariz pinhão / Diferencial - nariz piñón / Differential - pinion				F 19034		CRBS
Diferencial - pinhão cabeça / Diferencial - piñón cabeça / Differential - pinion head				H 715343 / H 715311	500588901	TRB

	OUT	IN		Fersa®	Nº OEM	
---	-----	----	---	---------------	--------	---

MASA

S 5000 * S 5002 * S 2030

Diferencial - pinhão cola / Diferencial - piñón cola / Differential - rear pinion				H 715334 / H 715311	500587901	TRB
--	--	--	--	------------------------	-----------	-----

Direção / Dirección / Steering

Perno de direção / Perno de dirección / Pintle direction				T 163	DIHA 3123 B2A	TRBT
				T 182	DIHA 3123 A2A	TRBT

Eixo Dianteiro / Eje Delantero / Front Axle

Roda / Rueda / Wheel	•		FE-900 Px200	3782 / 3720	807949	TRB
		•	FE-900 Px200	HM 212044 / HM 212011		TRB
	•			3782 / 3720	807949	TRB
		•		HM 212049 / HM 212011		TRB

Eixo Traseiro / Eje Trasero / Rear Axle

Roda / Rueda / Wheel	•		R140	580 / 572		TRB
		•	R140	598 A / 592 A		TRB
	•		R143	580 / 572		TRB
		•	R143	681 A / 672		TRB

S500T * S500U * S501U

Eixo Traseiro / Eje Trasero / Rear Axle

Diferencial (dir.) / Diferencial (der.) / Differential (right)				42381 / 42584	7451400	TRB
			Eaton 20223	42346 / 42584		TRB
Diferencial (esq.) / Diferencial (izq.) / Differential (left)				665 / 653		TRB
				68450 / 68712		TRB
Diferencial - nariz pinhão / Diferencial - nariz piñón / Differential - pinion			Eaton 20223	F 19034		CRBS
Diferencial - pinhão (cabeza - cola, direito) / Diferencial - piñón (cabeza / cola, derecho) / Differential - pinion (head - rear shaft, right)				72212 C / 72487		TRB
				78215 C / 78551		TRB

Direção / Dirección / Steering

Perno de direção / Perno de dirección / Pintle direction				T 163	DIHA 3123 B2A	TRBT
--	--	--	--	-------	---------------	------

Eixo Dianteiro / Eje Delantero / Front Axle

Roda / Rueda / Wheel	•			3782 / 3720	807949	TRB
		•		HM 212047 / HM 212011	C4TA1215B	TRB

Eixo Traseiro / Eje Trasero / Rear Axle

Roda / Rueda / Wheel	•			580 / 572		TRB
		•		594 A / 592 A		TRB
	•		Eaton 20223	665 / 652		TRB
		•	Eaton 20223	663 / 652		TRB

Ursus

Eixo Traseiro / Eje Trasero / Rear Axle

Diferencial - (dir. / esq.) / Diferencial - (der. / izq.) / Differential (right / left)				32021 XF		TRB
Diferencial - pinhão cabeça / Diferencial - piñón cabeça / Differential - pinion head				9278 / 9220		TRB
Diferencial - pinhão cola / Diferencial - piñón cola / Differential - rear pinion				HM 813843 / HM 813810		TRB

Eixo Dianteiro / Eje Delantero / Front Axle

Roda / Rueda / Wheel	•		12,000 lb.	3782 / 3720	807949	TRB
		•	12,000 lb.	HM 212047 / HM 212011	C4TA1215B	TRB

	OUT	IN		Fersa®	Nº OEM	
---	-----	----	---	---------------	--------	---

MERCEDES BENZ (SA)

1113 (LPO*OH) * 1114 LPO * 1115 L (OH) * 1118 LPO

Caixa de Mudanças / Caja de Cambios / Gearbox

Eixo de entrada (traseiro) / Eje de entrada (trasero) / Input shaft (rear)			G 3 / 36-5 / 8,98 * G 3 / 40-5 / 7,5	30309 F		TRB
Eixo intermediário / Eje intermedio / Intermediate shaft				30308 F	0019813105 / 0019815005	TRB
Eixo intermediário (dianteiro / traseiro) / Eje Intermedio (delantero / trasero) / Intermediate shaft (front / rear)				30309 F	00198113705	TRB
			G 3 / 36-5 / 8,98 * G 3 / 40-5 / 7,5	30309 F		TRB
Eixo primário (dianteiro) / Eje primario (delantero) / Primary shaft (front)			G 3 / 36-5 / 8,98 * G 3 / 40-5 / 7,5	QJ 209 FM	3459817027	BB4PAC
			G 3 / 50-5 / 8,5 * G 3 / 60-5 / 7,5 G 3 / 50-5 / 8,5 + NA 3 / 60-1B * G 3 / 60-5 / 7,5 + NA 3 / 60-1B	QJ 212 FM	3459817627	BB4PAC
Eixo primário (traseiro) / Eje primario (trasero) / Primary shaft (rear)			G 3 / 50-5 / 8 * G 3 / 60-5 / 7,5 G 3 / 50-5 / 8,5 + NA 3 / 60-1B * G 3 / 60-5 / 7,5 + NA 3 / 60-1B	F 19011		CRBS
				NU 209 FMN	3449817101	CRB
Eixo primário inf. (dianteiro / traseiro) / Eje primario inf. (delantero / trasero) / Primary shaft (front / rear)				6308 ZNR / C3	3129811325	BB
Eixo primário inf. (traseiro) / Eje primario inf. (trasero) / Primary shaft (rear)				NJ 2211 FM	000628000339	CRB
Eixo primário sup. (dianteiro / traseiro) / Eje primario sup. (delantero / trasero) / Upper primary shaft (front / rear)				30308 F	0019813105 / 0019815005	TRB
Eixo secundário (dianteiro) / Eje secundario (delantero) / Secondary shaft (front)				QJ 309 FM	3459817127 / 3459817727	BB4PAC

Eixo Traseiro / Eje Trasero / Rear Axle

Diferencial - coroa lateral (dir. / esq.) / Diferencial - corona lateral (der. / izq.) / Differential - crown gear (right / left)			HL 4 / 25 D-7,6 / 40:7 * HL 4 / 25 D-7,6 / 43:7 * HL 4 / 25 D-7,6 / 48:7 * HL 4 / 7,6 / 48:7 * HL 4 / 26 D-8,8 / 43:7	47487 / 47420 A		TRB
Diferencial - pinhão - apoio / Diferencial - piñón - apoyo / Differential - pinion support			733004	33111 F		TRB

Direção / Dirección / Steering



Direção hidráulica - alav. interna (inf.) / Dirección hidráulica - palanca interna (inf.) / Hydraulic direction - inner lever (lower)			LS	30205 F	000720030205	TRB
Direção hidráulica - alav. interna (sup.) / Dirección hidráulica - palanca interna (sup.) / Hydraulic direction - inner lever (upper)			LS	30206 F	000720030206	TRB

Eixo Dianteiro / Eje Delantero / Front Axle

Roda / Rueda / Wheel		•		30312 F	0019819705	TRB
			VL 2 / 13 C-2.9 1114	32306 F		TRB
		•		32307 F	0039816405	TRB
			VL 2 / 13 C-2.9 1114	33111 F		TRB
		•		33208 F	3849817605 / 0089810105	TRB
		•		33213 F	0089810005	TRB
		•		497 / 492 A	0009816105	TRB

Eixo Traseiro / Eje Trasero / Rear Axle

Roda / Rueda / Wheel		•		32216 F	0009817205	TRB
		•		33019 F	00298190 (77...)05 / 0039818605	TRB
		•		33215 F	0029818905 / 0029818605	TRB

	OUT	IN		Fersa [®]	N° OEM	
---	-----	----	---	---------------------------	--------	---

MERCEDES BENZ (SA)

1113 (LPO*OH) * 1114 (LPO) * 1115 L (OH) * 1118 (LPO)

Embreagem / Embrague / Clutch

Apoio / Apoyo / Support				6204	000625006204	BB
-------------------------	--	--	--	-------------	--------------	----

Motor / Motor / Engine

Alternador (dianteiro) / Alternador (delantero) / Alternator (front)			OM 366 * 352 * M 352 O	6303 2RS / C3		BB
				6403 2RS / C3	0049812425	BB
Alternador (traseiro) / Alternador (trasero) / Alternator (rear)			M 352 O * OM 352	6201 Z / C3		BB
			OM 366 * OM 352 * OM 364 LA	62201 2RS / C3		BB
Bomba d'água / Bomba de agua / Water pump				30302 F	000720030202	TRB
Bomba d'água (dianteiro) / Bomba de agua (delantero) / Water pump (front)				6203 C3	000625900208	BB
			OM 366 * OM 364 LA	6206 C3		BB
Bomba d'água (traseiro) / Bomba de agua (trasero) / Water pump (rear)			OM 366 * OM 364 LA	6203 C3		BB
				6206 C3	000625006206	BB
Bomba hidráulica / Bomba hidráulica / Hydraulic pump				62204 2RS	0049819625	BB
Bomba injetora (dianteiro) / Bomba inyectora (delantero) / Injection pump (front)				30203 F	000720030203	TRB
Bomba servo (dianteira) / Bomba servo (delantero) / Servopump (front)			OM 364 LA	62204 2RS		BB
Virabrequim / Cigüeñal / Crankshaft				6204 2RS / C3	000625406204	BB
Ventilador - comando da ventoinha (esq.) / Ventilador - control del ventilador (izd.) / Fan fan control (left)			OH 1115 L	6304 C3		BB
Virabrequim - ponta / Cigüeñal - punta / Crankshaft spindle			OM 366 * OM 352 / A / AI * M352 O	6204 2RS		BB

Tomada de Força / Toma de Fuerza / Power Take-off

Eixo de saída (traseiro) / Eje de salida (trasero) / Output shaft (rear)			G 3 / 60-5 / 7,5 + NA 3 / 60-1B G 3 / 50-5 / 7,5 + NA 3 / 60-1B	6007 N		BB
--	--	--	---	---------------	--	----

Tomada de Potência / Toma de Potencia / Power Take-off

Eixo primário (dianteiro) / Eje primario (delantero) / Primary shaft (front)				6206	000625006006	BB
Eixo primário (traseiro) / Eje primario (trasero) / Primary shaft (rear)				6007 N	000625506007	BB

1313 OH * 1314 OH * 1315 OH * 1316 (OH*OHL) * 1316 G (OH*OHL) * 1317 OH * 1318 OH * 1319 OH * 1320 (OH*OHL)

Caixa de Mudanças / Caja de Cambios / Gearbox

Eixo de entrada (traseiro) / Eje de entrada (trasero) / Input shaft (rear)			ZG 500-3 M / 1,64 * VG 500-3 W / 1,64	33209 F		TRB
Eixo de saída (dianteiro / traseiro) / Eje de salida (delantero / trasero) / Output shaft (front / rear)			ZG 500-3 M / 1,64 * VG 500-3 W / 1,64	33011 F		TRB
			ZG 500-3 M / 1,64 * VG 500-3 W / 1,64	33113 F		TRB
Eixo de saída (traseiro) / Eje de salida (trasero) / Output shaft (rear)			ZG 500-3 M / 1,64 * VG 500-3 W / 1,64	6211 N / C3		BB
Eixo intermediário (dianteiro) / Eje intermedio (delantero) / Intermediate shaft (front)				33210 F	0039818305	TRB
Eixo intermediário (dianteiro / traseiro) / Eje Intermedio (delantero / trasero) / Intermediate shaft (front / rear)				30309 F	00198113705	TRB
			G 3 / 40-5 / 7,5 * G 3 / 36-5 / 8,98 G 3 / 60-5 / 7,5 + NA 3 / 60-1B * G 3 / 60-5 / 8,5 + NA 3 / 60-1B	30308 F	0019813105 / 0019815005	TRB
Eixo intermediário (traseiro) / Eje intermedio (trasero) / Intermediate shaft (rear)				33212 F	0059812805	TRB

	OUT	IN		Fersa®	Nº OEM	
---	-----	----	---	---------------	--------	---

MERCEDES BENZ (SA)

1313 OH * 1314 OH * 1315 OH * 1316 (OH*OHL) * 1316 G (OH*OHL) * 1317 OH * 1318 OH * 1319 OH * 1320 (OH*OHL)

Eixo primário (dianteiro) / Eje primario (delantero) / Primary shaft (front)				QJ 212 FM	3459817627	BB4PAC
Eixo primário (traseiro) / Eje primario (trasero) / Primary shaft (rear)			G 3 / 60-5 / 7,5 + NA 3 / 60-1B G 3 / 60-5 / 8,5 + NA 3 / 60-1B * G 3 / 60-5 / 7,5	F 19011		CRBS
Eixo primário inf. dianteiro / Eje primario inf. (delantero) / Primary shaft (front)				6308 ZNR / C3	3129811325	BB
Eixo primário inf. (dianteiro / traseiro) / Eje primario inf. (delantero / trasero) / Primary shaft (front / rear)				6211 N / C3	0019819125	BB
				33112 F		TRB
Eixo primário inf. (traseiro) / Eje primario inf. (trasero) / Primary shaft (rear)				33011 F	0029819305	TRB
				NJ 2211 FM	000628000339	CRB
Eixo primário sup. (dianteiro) / Eje primario sup. (delantero) / Upper primary shaft (front)				30309 F	00198113705	TRB
				33210 F	0039818305	TRB
Eixo primário sup. (traseiro) / Eje primario sup. (trasero) / Upper primary shaft (rear)				30308 F	0019813105 / 0019815005	TRB
				33209 F	0039815705	TRB
Eixo secundário (traseiro) / Eje secundario (trasero) / Secondary shaft (rear)				QJ 309 FM	3459817127 / 3459817727	BB4PAC

Eixo Traseiro / Eje Trasero / Rear Axle

Diferencial - coroa lateral (dir. / esq.) / Diferencial - corona lateral (der. / izq.) / Differential - crown gear (right / left)			HH O5 D-10 / 43:10	32018 XF		TRB
			745004 / 007 / 012 / 033 / 035 / 036	32020 XF		TRB
			HH 4 / 12 D-10 / 40:7 * HL 4 / 26 D-9,2 / 48:7 * HL 4 / 26 D-9,2 / 43:7 * HL 4 / 14-8,8 / 43:7 * HL 4 / 27 D-10 / 43:7	47487 / 47420 A		TRB
Diferencial - pinhão (traseiro) / Diferencial - piñón (trasero) / Differential - pinion (rear)			745004 / 007 / 012 / 033 / 035 / 036	F 15083		TRBS
				F 15083	003981190 (77...) ⁵	TRBS

Eixo Dianteiro / Eje Delantero / Front Axle

Roda / Rueda / Wheel	•		AL 4 / 50-4,3 / 48:7	30214 F		TRB	
	•			32307 F	0039816405	TRB	
	•			33208 F	3849817605 / 0089810105	TRB	
	•			33209 F	0039815705	TRB	
		•		VL 3 / 7 D-5	33213 F	0089810005	TRB
		•		VL 3 / 7 D-5	33214 F		TRB
		•			33214 F	0039815605 / 0039815205	TRB
		•		AL 4 / 50-4,3 / 48:7	497 / 492 A	0009816105	TRB

Eixo Traseiro / Eje Trasero / Rear Axle

Roda / Rueda / Wheel		•		33019 F	00298190 (77...) ⁰⁵ / 0039818605	TRB
		•		33020 F	0059818505	TRB
		•		33117 F	0059818605	TRB
		•		33215 F	0029818905 / 0029818605	TRB
		•			598 A / 593 X	0039811405

Embreagem / Embrague / Clutch

Desengate / Desembrague / Clutch				6204 2RS	000625406104	BB
----------------------------------	--	--	--	-----------------	--------------	----

	OUT	IN		Fersa [®]	N° OEM	
---	-----	----	---	---------------------------	--------	---

MERCEDES BENZ (SA)

1313 OH * 1314 *OH * 1315 OH * 1316 (OH*OHL) * 1316 G (OH*OHL) * 1317 OH * 1318 OH * 1319 OH * 1320 (OH*OHL)

Motor / Motor / Engine

Alternador (dianteiro) / Alternador (delantero) / Alternator (front)		OM 366 A / G * OM 366 * OM 352 I	6303 2RS / C3	000625406303	BB
			6403 2RS / C3		BB
Alternador (traseiro) / Alternador (trasero) / Alternator (rear)			6201 2RS / C3	0049812425	BB
			62201 2RS / C3	000625406303	BB
Bomba d'água (dianteiro) / Bomba de agua (delantero) / Water pump (front)		OM 352 * OM 352 A * OM 352 I	6203 C3		BB
			6206 C3	000625900209	BB
Bomba d'água (dianteiro / traseiro) / Bomba de agua (delantero / trasero) / Water pump (front / rear)			6203 C3	000625900208	BB
Bomba d'água (traseiro) / Bomba de agua (trasero) / Water pump (rear)		OM 366 * OM 366 A * OM 366 G * OM 366 LA	6203 C3		BB
		OM 352 * OM 352 A * OM 352 I	6206 C3		BB
Bomba hidráulica / Bomba hidráulica / Hydraulic pump			62204 2RS	0049819625	BB
Bomba injetora (dianteiro) / Bomba inyectora (delantero) / Injection pump (front)			30203 F	000720030203	TRB
			30205 F	000720030205	TRB
Bomba injetora (traseiro) / Bomba inyectora (trasero) / Injection pump (rear)			30204 F	000720030204	TRB
		OM 366	30205 F		TRB
		OM 366 LA	30206 F		TRB
Virabrequim / Cigüeñal / Crankshaft			6204 2RS / C3	000625406204	BB
Polia tensora / Polea tensora / Tensioner pulley			6303	000635006303	BB
Ventilador (traseiro) / Ventilador (trasero) / Fan (rear)			6304 C3	000635006303	BB
Virabrequim - ponta / Cigüeñal - punta / Crankshaft spindle		OM 366 / A * OM 352 / A / I * OM 366 G * OM 366 LA	6204 2RS		BB

Tomada de Força / Toma de Fuerza / Power Take-off

Eixo de saída (traseiro) / Eje de salida (trasero) / Output shaft (rear)		G 3 / 60-5 / 7,5 + NA 3 / 60-1B * G 3 / 60-5 / 8,5 + NA 3 / 60-1B	6007 N		BB
--	--	--	---------------	--	----



Tomada de Potência / Toma de Potencia / Power Take-off

Eixo primário (traseiro) / Eje primario (trasero) / Primary shaft (rear)			6007 N	000625506007	BB
--	--	--	---------------	--------------	----

1418 OH * 1419 OH * 1420 (OH*OHL) * 1421 OHL

Caixa de Mudanças / Caja de Cambios / Gearbox

Eixo de acionamento / Eje de accionamiento / Drive shaft			NUP 2212 FMN		CRB
Eixo intermediário / Eje intermedio / Intermediate shaft			2789 / 2720		TRB
			3382 / 3320		TRB
Eixo intermediário (dianteiro / traseiro) / Eje Intermedio (delantero / trasero) / Intermediate shaft (front / rear)			30309 F	00198113705	TRB
			30308 F	0019813105 / 0019815005	TRB
			32208 F	A0159813405	TRB
		G 3 / 61-5 / 6,1 * G 3 / 60-5 / 7,5 * G 3 / 50-5 / 8,5 * G 3 / 60-5 / 7,5 + NA 3 / 60-1B * G 3 / 50-5 / 8,5 + NA 3 / 60-1B * G 3 / 60-5 / 8,5 + NA 3 / 60-1B	30308 F		TRB
Eixo primário / Eje primario / Primary shaft		G 3 / 55-6 / 8,5	F 19047		CRBS

	OUT	IN		Fersa®	N° OEM	
MERCEDES BENZ (SA)						
1418 OH * 1419 OH * 1420 (OH*OHL) * 1421 OHL						
Eixo primário (dianteiro) / Eje primario (delantero) / Primary shaft (front)			G 3 / 61-5 / 6,1 * G 3 / 60-5 / 7,5 * G 3 / 50-5 / 8,5 * G 3 / 50-5 / 8,5 + NA 3 / 60-1B * G 3 / 60-5 / 8,5 + NA 3 / 60-1B * G 3 / 5-5 / 8,5	QJ 212 FM		BB4PAC
				QJ 212 FM	3459817627	BB4PAC
Eixo primário (traseiro) / Eje primario (trasero) / Primary shaft (rear)			G 3 / 61-5 / 6,1 * G 3 / 60-5 / 7,5 * G 3 / 50-5 / 8,5 * G 3 / 50-5 / 8,5 + NA 3 / 60-1B * G 3 / 60-5 / 8,5 + NA 3 / 60-1B * G 3 / 5-5 / 8,5	F 19011		CRBS
Eixo primário inf. (traseiro) / Eje primario inf. (trasero) / Primary shaft (rear)				NJ 2211 FM	000628000339	CRB
Eixo primário sup. (dianteiro) / Eje primario sup. (delantero) / Upper primary shaft (front)				30309 F	00198113705	TRB
Eixo primário sup. (traseiro) / Eje primario sup. (trasero) / Upper primary shaft (rear)				30308 F	0019813105 / 0019815005	TRB
Eixo principal / Eje principal / Main shaft				NUP 310 FMN / C3		CRB
Eixo principal (entrada / saída) / Eje principal (entrada / salida) / Main shaft (input / output)				32210 F	A0159815005	TRB
Eixo secundário / Eje secundario / Secondary shaft			G 3 / 55-6 / 8,5	F 19046		CRBS
Eixo secundário (traseiro) / Eje secundario (trasero) / Secondary shaft (rear)			G 3 / 55-6 / 8,5	F 19046		CRBS
				QJ 309 FM	3459817127 / 3459817727	BB4PAC
Tomada de força / Toma de fuerza / Power take-off				6208 N		BB
Eixo Traseiro / Eje Trasero / Rear Axle						
Diferencial - caixa sat.lat. (dir.) / Diferencial - caja sat.lat. (der.) / Differential - satellit box (right)				32014 XF	005 981 6605	TRB
				32022 XF	002 981 5005	TRB
Diferencial - caixa sat.lat (esq.) / Diferencial - caja sat.lat. (izq.) / Differential - satellit box (left)				32017 XF	005 981 1405	TRB
Diferencial - coroa lateral (dir. / esq.) / Diferencial - corona lateral (der. / izq.) / Differential - crown gear (right / left)			HL 4 / 60 D-10 * HL 4 / 061 D-11,5 * HH 4 / 05 D-10 / 43:10 * HH 4 / 07 DL-10 / 41:7 * HH 4 / 07 DL-10 / 47:9	32018 XF		TRB
			HL 5 / 60 DZ-10 * HL 5 / 60 DZ-10 / 39:8	32020 XF		TRB
			HH 4 / 12-10 / 41:11 * HH 4 / 12D-10 / 40:7 * HL 4 / 26 D-9,2 / 43:7 * HH 4 / 12 D-10 / 41:11 * HL 4 / 26 D-9,2 / 40:7	47487 / 47420 A		TRB
Diferencial - pinhão (traseiro) / Diferencial - piñón (trasero) / Differential - pinion (rear)			HL 5 / 2 DZ-10 / 48:7 * HH 4 / 12 D-10 / 41:11 * HL 4 / 26 D-9,2 / 40:7 * HL 5 / 2 DZ-10 / 43:7 * HL 5 / 60 DZ-10 * HL 5 / 60 DZ-10 / 39:8	F 15083		TRBS
				F 15083	003981190 (77...)5	TRBS
Diferencial (traseiro) / Diferencial (trasero) / Differential - differential (rear)			HL 5 / 2 DZ 10 / 48:7	32020 XF		TRB
Direção / Dirección / Steering						
Inferior / Inferior / Lower				30205 F	000720030205	TRB
Braço superior / Brazo superior / Upper arm				30206 F	000720030206	TRB
Eixo Dianteiro / Eje Delantero / Front Axle						
Roda / Rueda / Wheel	•			33208 F	3849817605 / 0089810105	TRB

	OUT	IN		Fersa®	N° OEM	
---	-----	----	---	---------------	--------	---

MERCEDES BENZ (SA)

1418 OH * 1419 OH * 1420 (OH*OHL) * 1421 OHL

Roda / Rueda / Wheel	•			33210 F	003 981 8305	TRB
		•		33213 F	0089810005	TRB
		•		33214 F	003 981 5205	TRB
		•		559 / 552 A	3449817005	TRB
	•		VL 3 / 7 D-5 (504304 38 / 39 / 40 / 41 / 44 / 45 / 46 / 47 / 50 / 51) * VL 3 / 8 D-6,5	33210 F		TRB

Eixo Traseiro / Eje Trasero / Rear Axle

Roda / Rueda / Wheel		•	HL 4 / D2-8 / 46:7	32216 F		TRB
		•		33019 F	00298190 (77...)05 / 0039818605	TRB
		•		33020 F	0059818505	TRB
		•		33020 F	014 981 3205	TRB
		•		33116 F	012 981 4005	TRB
	•		HH 4 / 05 D-10 / 43:10 * HH 4 / 07 DL-10 / 41:7 * HH 4 / 07 DL-10 / 47:9	33117 F		TRB
		•		33117 F	0059818605	TRB
		•		33215 F	0029818905 / 0029818605	TRB
		•		598 A / 593 X	0039811405	TRB

Motor / Motor / Engine

Alternador (dianteiro) / Alternador (delantero) / Alternator (front)				6303 2RS / C3	000625406303 / 000625900193	BB
				6304 2RS / C3	0049812425	BB
			OM 366 * OM 366 A (Bosch / Valeo 14V 55 A) * OM 366 LA II / 23	6403 2RS / C3		BB
Alternador (traseiro) / Alternador (trasero) / Alternator (rear)				62201 2RS / C3	00298190 (77...)95	BB
Bomba d'água (dianteiro) / Bomba de agua (delantero) / Water pump (front)				6203	000625900208	BB
Bomba d'água (traseiro) / Bomba de agua (trasero) / Water pump (rear)				6206	000625006206	BB
			OM 366 * OM 366 A * OM 366 LA	6203 C3		BB
Bomba hidráulica / Bomba hidráulica / Hydraulic pump				62204 2RS	0049819625	BB
Bomba injetora (dianteiro) / Bomba inyectora (delantero) / Injection pump (front)				30203 F	000720030203	TRB
				30204 F	000720030204	TRB
Virabrequim / Cigüeñal / Crankshaft				6204 2RS / C3	000625406204	BB
Polia tensora (dianteiro) / Polea tensora (delantero) / Tensioner pulley (front)				30205 F	000720030205	TRB
Polia tensora (traseiro) / Polea tensora (trasero) / Tensioner pulley (rear)				30204 F	000720030204	TRB
Polia tensora - rodam (dianteiro) / Polea tensora - rodam. delantero / Tensioner pulley - bearing (front)			OM 355 / 5 * OH-1419 / 1420	30205 F		TRB
Polia tensora - rodam (traseiro) / Polea tensora - rodam. trasero / Tensioner pulley - bearing (rear)			OM 355 / 5 * OH-1419 / 1420	30204 F		TRB
Ventilador (dianteiro) / Ventilador (delantero) / Fan (front)				30205 F	000720030205	TRB
Ventilador (traseiro) / Ventilador (trasero) / Fan (rear)				30204 F	000720030204	TRB
Virabrequim - ponta / Cigüeñal - punta / Crankshaft spindle			OM 366 / A * OM 355 / 5	6204 2RS		BB

	OUT	IN		Fersa®	Nº OEM	
---	-----	----	---	---------------	--------	---

MERCEDES BENZ (SA)

1418 OH * 1419 OH * 1420 (OH*OHL) * 1421 OHL

Vírbrequim - ponta / Cigüeñal - punta / Crankshaft spindle			OM 366 * OM 366 A * OM 366 LA * OM 366 LA II / 23	6204 2RS		BB
---	--	--	---	-----------------	--	----

Tomada de Força / Toma de Fuerza / Power Take-off

Eixo de saída (traseiro) / Eje de salida (trasero) / Output shaft (rear)			G 3 / 60-5 / 7,5 + NA 3 / 60-1B * G 3 / 60-5 / 8,5 + NA 3 / 60-1B * G 3 / 50-5 / 8,5 + NA 3 / 60-1B	6007 N		BB
---	--	--	---	---------------	--	----



Tomada de Potência / Toma de Potencia / Power Take-off

Eixo primário (dianteiro) / Eje primario (delantero) / Primary shaft (front)				6208 N	000625506208	BB
Eixo primário (traseiro) / Eje primario (trasero) / Primary shaft (rear)				6007 N	000625506007	BB

1517 OH * 1518 OH * 1519 OH * 1520 OH * 1521 OH

Caixa de Mudanças / Caja de Cambios / Gearbox

Eixo de entrada / Eje de entrada / Input shaft				6209 C3	000625036209	BB
			718052	6209 C3		BB
Eixo de saída (traseiro) / Eje de salida (trasero) / Output shaft (rear)				6007 N	000625506007	BB
				6208 N	000625506208	BB
Eixo intermediário / Eje intermedio / Intermediate shaft				6208 N	000625506208	BB
Eixo intermediário (dianteiro) / Eje intermedio (delantero) / Intermediate shaft (front)				33885 / 33822	0019809602	TRB
Eixo intermediário (dianteiro / traseiro) / Eje Intermedio (delantero / trasero) / Intermediate shaft (front / rear)				30308 F	0019813105 / 0019815005	TRB
				33889 / 33822	0019809502	TRB
Eixo primário / Eje primario / Primary shaft				6208 N	000625506208	BB
Eixo primário / Eje primario / Primary shaft			AK 6-80 / 9,0	NUP 314 FMNR / C3		CRB
Eixo primário (dianteiro) / Eje primario (delantero) / Primary shaft (front)				QJ 209 FM	3459817027	BB4PAC
				QJ 212 FM	3459817627	BB4PAC
Eixo primário (traseiro) / Eje primario (trasero) / Primary shaft (rear)			3 / 60-5 / 6,1 * G 3 / 61-5 / 6,1 * G 3 / 50-5 / 8,5 * G 3 / 60-5 / 7,5 * AK 6-80 / 9,0 * AK 6-80 / 9,0 GV 80 * G 3 / 60-5 / 7,5 + NA 3 / 60-1B * G 3 / 60-5 / 8	F 19011		CRBS
				NU 209 FMN	3449817101	CRB
Eixo secundário / Eje secundario / Secondary shaft				F 19019	49815801	CRBS
Eixo secundário (interm.) / Eje secundario (interm.) / Secondary shaft (interm.)			LP / LPK / LPS-1520	NUP 314 FM		CRB
Eixo secundário (traseiro) / Eje secundario (trasero) / Secondary shaft (rear)			LP / LPK / LPS-1520	6314		BB
				6314 N / C3	00198190 (77...)25	BB
			G 3 / 60-5 / 6,1 * G 3 / 36-5 / 8,98 * G 3 / 40-5 / 7,5 * G 3 / 61-5 / 6,1 * G 3 / 50-5 / 8,5 * G 3 / 60-5 / 7,5 * AK 6-80 / 9,0 * AK 6-80 / 9,0 GV 80 * G 3 / 60-5 / 7,5 + NA 3 / 60-1B	QJ 309 FM		BB4PAC
				QJ 309 FM	3459817127 / 3459817727	BB4PAC
Motora traseira / Motor trasero / Rear engine				NUP 314 FM / C3	0019809802	CRB

	OUT	IN		Fersa®	N° OEM	
---	-----	----	---	---------------	--------	---

MERCEDES BENZ (SA)

1517 OH * 1518 OH * 1519 OH * 1520 OH * 1521 OH

Cardan / Cardan / Cardan

Motora traseira / Motor trasero / Rear engine				6210	000625006210	BB
Suporte / Soporte / Support			LP / LPK / LPS-1520	6210		BB

Eixo Traseiro / Eje Trasero / Rear Axle

Diferencial - coroa lateral (dir. / esq.) / Diferencial - corona lateral (der. / izq.) / Differential - crown gear (right / left)			HL 4 / 01 D-10 / 38:8 * HL 4 / 01 D-10 * HL4 / 01 D-10 / 48:7 * HH 4 / 05 D-10 / 43:10	32018 XF		TRB
			HL 5 / 2 D-10 / 39:8 * HL 5 / 2 DZ-10 / 48:7 * HL 5 / 2 D-10 / 45:8 * HL 5 / 2-10 / 39:8	32020 XF		TRB
			HH 4 / 12-10 / 40:7 * HL 4 / 27 D-10 / 43:7 * HH 4 / 12-10 / 40:7 * HH 4 / 12-10 / 40:7	47487 / 47420 A		TRB
Diferencial - pinhão (dianteiro) / Diferencial - piñón (delantero) / Differential - pinion (front)			LP / LPK / LPS-1520	HM 807046 / HM 807010		TRB
Diferencial - pinhão apoio / Diferencial - piñón apoyo / Differential - support pinion				F 15083	003981190 (77...) ⁵	TRBS
Diferencial - pinhão (dianteiro) / Diferencial - piñón (delantero) / Differential - pinion (front)				HM 807046 / HM 807010	031981190 (77...) ⁵	TRB
Diferencial - pinhão (traseiro) / Diferencial - piñón (trasero) / Differential - pinion (rear)			HL 5 / 2D-10 / 39:8 * HL 5 / 2DZ-10 / 48:7 * HL 5 / 2D-10 / 45:8 * HL 5 / 2-10 / 39:8	F 15083		TRBS

Direção / Dirección / Steering

Direção hidráulica - árvore artic. (sup.) / Dirección hidráulica - árbol artic. (sup.) / Hydraulic direction - artic. shaft (upper)			LP / LPK / LPS-1520	6007		BB
---	--	--	---------------------	-------------	--	----

Eixo Dianteiro / Eje Delantero / Front Axle



Roda / Rueda / Wheel	•		LP / LPK / LPS-1520	30313 F		TRB
	•			32307 F	0039816405	TRB
	•		LP / LPK / LPS-1520	32309 F		TRB
	•			33208 F	3849817605 / 0089810105	TRB
	•			33213 F	0089810005	TRB
	•				559 / 552 A	3449817005



Eixo Traseiro / Eje Trasero / Rear Axle

Roda / Rueda / Wheel	•			32216 F	0009817205	TRB
		•		32218 F	000720032218	TRB
		•		33019 F	00298190 (77...) ⁰⁵ / 0039818605	TRB
		•		33020 F	0059818505	TRB
	•			33117 F	0059818605	TRB
	•			33215 F	0029818905 / 0029818605	TRB
				497 / 492 A	0009816105	TRB
				498 / 492 A	0039812005	TRB
	•		LP / LPK / LPS-1520	580 / 572		TRB
		•		598 A / 593 X	0039811405	TRB
				H 715345 / HM 715311	0319811805	TRB

Embreagem / Embrague / Clutch

Apoio / Apoyo / Support			344938 / 955 / 963	6204 2RS		BB
-------------------------	--	--	--------------------	-----------------	--	----

	OUT	IN		Fersa®	Nº OEM	
MERCEDES BENZ (SA)						
1517 OH * 1518 OH * 1519 OH * 1520 OH * 1521 OH						
Apoio / Apoyo / Support				6204 2RS / C3	000625406204	BB
				6205 2RS	000625406205	BB
Motor / Motor / Engine						
Alternador (dianteiro) / Alternador (delantero) / Alternator (front)				6303 2RS / C3	000625406303 / 000625900193	BB
				6303 RS / C3	000625900182	BB
Alternador (dianteiro / traseiro) / Alternador (delantero / traseiro) / Alternator (front / rear)				6403 2RS / C3	0049812425 / 0049811825	BB
Alternador (traseiro) / Alternador (traseiro) / Alternator (rear)				6201 2RS / C3	0089810705	BB
				6201 RS / C3	0049812425	BB
				6204 2RS / C3	000625406204	BB
				6205 2RS	000625406205	BB
				62201 2RS / C3	00298190 (77...)25	BB
				6403 2RS / C3		BB
Bomba d'água (dianteiro) / Bomba de agua (delantero) / Water pump (front)				6204	000625006204	BB
Bomba d'água (dianteiro / traseiro) / Bomba de agua (delantero / traseiro) / Water pump (front / rear)				6203 C3	000625900208	BB
Bomba d'água (traseiro) / Bomba de agua (traseiro) / Water pump (rear)				6004	000625006004	BB
		OM 366 A / LA		6203 C3		BB
				6206 C3	000625900209	BB
				NU 303 FM	0019819601	CRB
Bomba hidráulica / Bomba hidráulica / Hydraulic pump				62204 2RS	0049819625	BB
Bomba injetora (dianteiro) / Bomba inyectora (delantero) / Injection pump (front)				6305	000625006305	BB
				30203 F	000720030203	TRB
				32205 F	000720032205	TRB
Bomba injetora (dianteiro / traseiro) / Bomba inyectora (delantero / traseiro) / Injection pump (front / rear)		OM 355 / 5A		32205 BF		TRB
Bomba injetora (traseiro) / Bomba inyectora (traseiro) / Injection pump (rear)				6205	000625006205	BB
				30205 F	000720030205	TRB
Compressor / Compresor / Compressor		LP-1520		6011		BB
Compressor (dianteiro) / Compresor (delantero) / Compressor (front)		OM 355 / 5A		NJ 305 C3		CRB
Compressor de ar / Compresor de aire / Air compressor				6011	000625006011	BB
				6305	000625006305	BB
Compressor de ar (dianteiro) / Compresor de aire (delantero) / Air compressor (front)				NJ 305 FM / C3	005412400004	CRB
				NUP 206 FM	005412400004	CRB
Compressor - árvore / Compresor - eje de la turbina / Compressor shaft turbine		LP / LPK / LPS-1520		6305		BB
Dinamo Bosch (dianteiro) / Dinamo bosch (delantero) / Bosch dynamo (front)		LP / LPK / LPS-1520		6204		BB
Dinamo Bosch (traseiro) / Dinamo bosch (traseiro) / Bosch dynamo (rear)		LP / LPK / LPS-1520		6004		BB
Polia tensora (dianteiro) / Polea tensora (delantero) / Tensioner pulley (front)				30205 F	000720030205	TRB
Polia tensora (traseiro) / Polea tensora (traseiro) / Tensioner pulley (rear)				30204 F	000720030204	TRB
Ventilador (dianteiro) / Ventilador (delantero) / Fan (front)				30205 F	000720030205	TRB

	OUT	IN		Fersa®	N° OEM	
---	-----	----	---	---------------	--------	---

MERCEDES BENZ (SA)

1517 OH * 1518 OH * 1519 OH * 1520 OH * 1521 OH

Ventilador (traseiro) / Ventilador (trasero) / Fan (rear)				30204 F	000720030204	TRB
Virabrequim - ponta / Cigüeñal - punta / Crankshaft spindle			OM 352 A * OM 355 * OM 366 A / LA * OM 352	6204 2RS		BB
			OM 355 A / 5-I	6205 2RS		BB

1621 L (OH) * 1623 LG (OH) * 1625 (OH) * 1625 L (OH) * 1628 L (OH) * 1630 L (OH) * 1635 (OH) * 1636 L (OH)

Caixa de Mudanças / Caja de Cambios / Gearbox

Eixo intermediário (dianteiro) / Eje intermedio (delantero) / Intermediate shaft (front)			S 6-90 / 9,01 * 16 S-130 * S 6-90 / 9,01 + N 70 / 18 * S 6-90 / 6,98 * 8 S-1350 * S 6-1550 / 6,98 * S 6-1550 * S 6-105	F 15047		TRBS
Eixo intermediário (dianteiro / traseiro) / Eje Intermedio (delantero / trasero) / Intermediate shaft (front / rear)			G 3 / 60-5 / 7,5 * G 3 / 50-5 / 8,5 * G 3 / 55-6 / 8,5 * G 3 / 50-5 / 8,5 * G 3 / 60-5 / 7,5 + NA 3 / 60-1B * G 3 / 50-5 / 8,5 + NA 3 / 60-1B * 16 S-1650 * S 6-1550 / 6,98 + ESI	30308 F		TRB
Eixo intermediário (traseiro) / Eje intermedio (trasero) / Intermediate shaft (rear)			S 6-90 / 9,01 * S 6-90 / 9,0 + N 70 / 18 * S 6-90 / 6,98 * S 6-1550 / 6,98 * S 6-1550 * S 6-105 * S 6-1550 / 6,98 + ESI	32309 F		TRB
			16 S-130 * 8 S-1350 * 16 S-1650	32310 F		TRB
Eixo primário / Eje primario / Primary shaft			S 6-90 / 9,0 + N 70 / 18 (ZF)	6208 N		BB
			G 3 / 50-5 / 8,5	F 19047		CRBS
			S 6-90 / 9,01 (ZF) * S 6-1550 / 6,98 * S 6-90 / 6,98 * S 6-1550 *	NUP 314 FMNR / C3		CRB
Eixo primário (dianteiro) / Eje primario (delantero) / Primary shaft (front)			G 3 / 60-5 / 7,5 * G 3 / 50-5 / 8,5 * G 3 / 60-5 / 7,5 + NA 3 / 60-1B * G 3 / 50-5 / 8,5 + NA 3 / 60-1B	QJ 212 FM		BB4PAC
Eixo primário (traseiro) / Eje primario (trasero) / Primary shaft (rear)			G 3 / 60-5 / 7,5 * G 3 / 50-5 / 8,5 * G 3 / 60-5 / 7,5 + NA 3 / 60-1B * G 3 / 50-5 / 8,5 + NA 3 / 60-1B	F 19011		CRBS
Eixo secundário / Eje secundario / Secondary shaft			4 S-120 GP * 4 S-120 GP + N 70 / 18	NUP 311 FMNR / C3		CRB
Eixo secundário (traseiro) / Eje secundario (trasero) / Secondary shaft (rear)			S 6-1550 / 6,98 * S 6-90 / 6,98	6314 C3		BB
			G 3 / 55-6 / 8,5	F 19046		CRBS
			S 6-1550 * S 6-105 * S 6-1550 / 6,98 + ESI	NUP 314 FMNR / C3		CRB
			G 3 / 60-5 / 7,5 * G 3 / 50-5 / 8,5 * G 3 / 60-5 / 7,5 + NA 3 / 60-1B	QJ 309 FM		BB4PAC
Tampa (traseiro) / Cubierta (trasero) / Cover (rear)			16 S-130 * 8 S-1350 * 16 S-1650	6218 C3		BB

Cardan / Cardan / Cardan

Suporte / Soporte / Support			L-1614	6210		BB
-----------------------------	--	--	--------	-------------	--	----

Eixo Traseiro / Eje Trasero / Rear Axle

Diferencial - coroa lateral (dir. / esq.) / Diferencial - corona lateral (der. / izq.) / Differential - crown gear (right / left)			HL 4 / 01 D-10 / 43:10 * HL 4 / 01 D-10 / 43:10 * HL 4 / 01 D-10 / 41:7 * HL 4 / 01 D-10 / 47:9 * HL 4 / 01 D-10 / 43:7 * HH 4 / 07 DL-1	32018 XF		TRB
---	--	--	---	-----------------	--	-----

	OUT	IN		Fersa [®]	Nº OEM	
---	-----	----	---	---------------------------	--------	---

MERCEDES BENZ (SA)

1621 L (OH) * 1623 LG (OH) * 1625 (OH) * 1625 L (OH) * 1628 L (OH) * 1630 L (OH) * 1635 (OH) * 1636 L (OH)

Diferencial - coroa lateral (dir. / esq.) / Diferencial - coroa lateral (der. / izq.) / Differential - crown gear (right / left)			HL 5 / 2 DZ10:48:7 * HL 5 / 60 DZ-10 * HL 5 / 2 DZ-10 / 43:7 * HL 5 / 61 DZ-10 / 39:8 * HL 5 / 60 DZ-10 / 39:8 * HL 4 / 050 DC-11,5 * HL 4 / 061 D-11,5	32020 XF		TRB
			HL 7 / 021 D-10 / 26:24 * HL 7 / 021 D-10 / 29:25 * HL 7 / 021 D-10 / 3,77 * HL 7 / 022 D-12,3 / 3,43 * HL 7 / 021 D-10 / 3,83	33115 F		TRB
			HL 4 / 27 D-10 / 40:7 * HL 4 / 27 D-10 / 39:8 40:7 * HH 4 / 12-10 / 40:7	47487 / 47420 A		TRB
Diferencial - pinhão (dianteiro) / Diferencial - piñón (delantero) / Differential - pinion (front)			HL 7 / 02 D-10 / 29:25 * HL 7 / 021 D-10 / 26:24 * HL 7 / 021 D-10 / 3,77 * HL 7 / 022 D-12,3 / 3,43 * HL 7 / 021 D-10 / 3,83	31313 F		TRB
Diferencial - pinhão (traseiro) / Diferencial - piñón (traseiro) / Differential - pinion (rear)			HL 7 / 021 D-10 / 29:25 * HL 7 / 021 D-10 / 26:24 * HL 7 / 021 D-10 / 3,77 * HL 7 / 022 D-12,3 / 3,43 * HL 7 / 021 D-10 / 3,83	32314 BF		TRB
			HL 5 / 2 DZ10 / 48:7 * HL 5 / 60 DZ-10 * HL 5 / 2 DZ-10 / 43:7 * HL 5 / 61 DZ-10 / 39:8 * HL 5 / 60 DZ-10 / 39:8	F 15083		TRBS

Direção / Dirección / Steering

Alavanca intermediária / Palanca intermedia / Intermediate lever			OF-1618 / 1620	30205 F		TRB
			OF-1618 / 1620	30206 F		TRB

Motor / Motor / Engine

Alternador (dianteiro) / Alternador (delantero) / Alternator (front)			OM 366 A / LA * OM 449 A / LA	6303 2RS / C3		BB
			OM 449 A * OM 366 * OM 366 A * OM 366 LA II / 23	6403 2RS / C3		BB
Alternador (traseiro) / Alternador (traseiro) / Alternator (rear)			OM 449 A / LA * OM 366 A / LA (28V * 35A / 28 A * 14V * 55 A-Bosch) * OM 366 LA II / 23	62201 2RS / C3		BB
Bomba d'água (dianteiro) / Bomba de agua (delantero) / Water pump (front)			OM 366 * OM 366 A / LA * OM 366 LAG	6206 C3		BB
Bomba d'água (traseiro) / Bomba de agua (traseiro) / Water pump (rear)			OM 366 * OM 366 A / LA * M 366 LAG	6203 C3		BB
Virabrequim - ponta / Cigüeñal - punta / Crankshaft spindle			OM 366 A / LA * M 366 LAG	6204 2RS		BB

Tomada de Força / Toma de Fuerza / Power Take-off

Eixo de saída (traseiro) / Eje de salida (traseiro) / Output shaft (rear)			G 3 / 60-5 / 7,5 + NA 3 / 60-1B * G 3 / 50-5 / 8,5 + NA 3 / 60-1B	6007 N		BB
			S 6-90 / 9,0 + N 70 / 18	6208 N		BB
Eixo intermediário / Eje intermedio / Intermediate shaft			4 S-120 GP + N 70 / 18	6209 C3		BB

1721 L (OH)

Caixa de Mudanças / Caja de Cambios / Gearbox

Corpo sincronizador (traseiro) / Cuerpo sincronizador (traseiro) / Synchronizer (rear)			4S-120 GP	6213 C3		BB
Eixo de acionamento / Eje de accionamiento / Drive shaft				NUP 2212 FMN		CRB

	OUT	IN		Fersa [®]	N° OEM	
---	-----	----	---	---------------------------	--------	---

MERCEDES BENZ (SA)

1721 L (OH)						
Eixo de saída (traseiro) / Eje de salida (trasero) / Output shaft (rear)			G 3 / 50-5 / 8,5 + NA 3 / 60-1B * G 3 / 60-5 / 7,5 + NA 3 / 60-1B	6007 N		BB
Eixo de saída (traseiro) / Eje de salida (trasero) / Output shaft (rear)			S 6-90 / 9.01 + N 70 / 1B	6208 N		BB
Eixo intermediário (dianteiro) / Eje intermedio (delantero) / Intermediate shaft (front)			S 6-90 * S 6-90 / 9,01 * S 6-90 / 9.01 + N 70 / 1B * 8S-1350	F 15047		TRBS
Eixo intermediário (dianteiro / traseiro) / Eje Intermedio (delantero / trasero) / Intermediate shaft (front / rear)				30308 F	0019813105 / 0019815005	TRB
			G 3 / 50-5 / 8,5 + NA 3 / 60-1B * G 3 / 60-5 / 7,5 * G 3 / 50-5 / 8,5 * G 3 / 55-6 / 8,5 * G 3 / 60-5 / 7,5 + NA 3 / 60-1B	30308 F		TRB
Eixo intermediário (traseiro) / Eje intermedio (trasero) / Intermediate shaft (rear)				32309 F	0049811305	TRB
			8S-1350	32310 F		TRB
			S 6-90 / 9.01 + N 70 / 1B	6009 C3		BB
Eixo primário / Eje primario / Primary shaft			G 3 / 55-6 / 8,5	F 19047		CRBS
			S 6-90 * S 6-90 / 9.01 + N 70 / 1B	NUP 314 FMNR / C3		CRB
Eixo primário (dianteiro) / Eje primario (delantero) / Primary shaft (front)				QJ 212 FM	3459817627	BB4PAC
Eixo primário (traseiro) / Eje primario (trasero) / Primary shaft (rear)			G 3 / 50-5 / 8,5 + NA 3 / 60-1B * G 3 / 50-5 / 8,5	F 19011		CRBS
Eixo principal (saída) / Eje principal (salida) / Main shaft (output)				NUP 310 FMN / C3		CRB
Eixo secundário / Eje secundario / Secondary shaft				F 19019	49815801	CRBS
Eixo secundário (traseiro) / Eje secundario (trasero) / Secondary shaft (rear)			S 6-90	6314		BB
			S 6-90 / 9.01 + N 70 / 1B	6314 C3		BB
			G 3 / 55-6 / 8,5	F 19046		CRBS
			4S-120 GP	NUP 311 FMNR / C3		CRB
			G 3 / 50-5 / 8,5 + NA 3 / 60-1B * G 3 / 60-5 / 7,5 * G 3 / 50	QJ 309 FM		BB4PAC
				QJ 309 FM FM	0009813105	BB4PAC
Tampa (traseiro) / Cubierta (trasero) / Cover (rear)			8S-1350	6218 C3		BB
Tomada de força / Toma de fuerza / Power take-off				6208 N	000625506208	BB

Eixo Traseiro / Eje Trasero / Rear Axle

Diferencial - coroa lateral (dir. / esq.) / Diferencial - corona lateral (der. / izq.) / Differential - crown gear (right / left)			HL 4 / 10 D-10 / 43:7 * HL 4 / 10 D-10 / 41:7 * HL 4 / 10 D-10 / 47:9 * HL 4 / 01 D-10 / 41:7 * HL 4 / 01 D-10 / 43:7 * HL 4 / 01 D	32018 XF		TRB
			HL 5 / 2 DZ-10 / 43:7 * HL 5 / 2 DZ-10 / 48:7 * HL 5 / 60 DZ-10 / 39:8 * HL 5 / 60 DZ-10 * HL 5 / 61 DZ-10 / 39:8	32020 XF		TRB
			HL 7 / 021 D-10 / 3,77	33115 F		TRB
			HL 4 / 27 D-10 / 40:7 * HL 4 / 27 D-10 / 42:8 * HL 4 / 27 D-10 / 43:7 * HL 4 / 27 D-10 / 39:8	47487 / 47420 A		TRB

	OUT	IN		Fersa®	Nº OEM	
---	-----	----	---	---------------	--------	---

MERCEDES BENZ (SA)

1721 L (OH)

Diferencial - coroa lateral (dir.) / Diferencial - corona lateral (der.) / Differential - crown gear (right)			AL 4 / 6 DS-6 / 43:7	47487 / 47420 A		TRB
Diferencial - pinhão (dianteiro) / Diferencial - piñón (delantero) / Differential - pinion (front)			HL 7 / 021 D-10 / 3,77	31313 F		TRB
Diferencial - pinhão (traseiro) / Diferencial - piñón (trasero) / Differential - pinion (rear)			HL 7 / 021 D-10 / 3,77	32314 BF		TRB
			HL 5 / 2 DZ-10 / 43:7 * HL 5 / 2 DZ 10 / 48:7 * HL 5 / 60 DZ-10 / 39:8 * HL 5 / 60 DZ-10 * HL 5 / 61 DZ-10 / 39:8	F 15083		TRBS

Eixo Dianteiro / Eje Delantero / Front Axle



Roda / Rueda / Wheel	•		AL 4 / 6 DS-6 / 43:7	32017 XF		TRB
		•		32310 F	0019817405	TRB
		•	AL 4 / 6 DS-6 / 43:7	33019 F		TRB
	•			33208 F	3849817605 / 0089810105	TRB
	•			33210 F	0039818305	TRB
		•	VL 3 / 7 D-5	33213 F		TRB
		•		33213 F	0089810005	TRB
		•		33214 F	0039815605 / 0039815205	TRB
	•			F 15051 C	0059813105	TRBS

Eixo Traseiro / Eje Trasero / Rear Axle

Roda / Rueda / Wheel	•		HL 7 / 021 D-10 / 3,77	33019 F		TRB
		•		33019 F	00298190 (77...)05 / 0039818605	TRB
		•		33020 F	0059818505	TRB
		•		33020 F	014 981 3205	TRB
		•	HL 7 / 021 D-10 / 3,77	33021 F		TRB
	•			33116 F	012 981 4005	TRB
	•			33117 F	0059818605	TRB
	•			33215 F	0029818905 / 0029818605	TRB

Motor / Motor / Engine

Alternador (dianteiro) / Alternador (delantero) / Alternator (front)				6303 ZZ / C3	000625900182	BB
				6303 ZZ / C3	000625900193	BB
			OM 366 * OM 366 A / LA (Bosch 14V 55 A) * OM 366 LA II / 23	6403 2RS / C3		BB
Alternador (traseiro) / Alternador (trasero) / Alternator (rear)				62201 2RS / C3	00298190 (77...)95	BB
Bomba d'água (dianteiro) / Bomba de agua (delantero) / Water pump (front)				6206 C3	000625900209	BB
			OM 366 * OM 366 A / LA	6206 C3		BB
Bomba d'água (traseiro) / Bomba de agua (trasero) / Water pump (rear)			OM 366 * OM 366 A / LA	6203 C3		BB
				6203 C3	000625900208	BB
Bomba hidráulica / Bomba hidráulica / Hydraulic pump				62204 2RS	0049819625	BB
Bomba injetora (dianteiro) / Bomba inyectora (delantero) / Injection pump (front)				30203 F	000720030203	TRB
Bomba injetora (traseiro) / Bomba inyectora (trasero) / Injection pump (rear)				30204 F	000720030204	TRB

	OUT	IN		Fersa®	Nº OEM	
---	-----	----	---	---------------	--------	---

MERCEDES BENZ (SA)

1721 L (OH)

Virabrequim / Cigüenhal / Crankshaft				6204 2RS / C3	000625406204	BB
Virabrequim - ponta / Cigüenhal - punta / Crankshaft spindle			OM 366 * OM 366 A / LA * OM 366 LA II / 23 * OM 449 LA	6204 2RS		BB

Tomada de Potência / Toma de Potencia / Power Take-off

Eixo de saída (traseiro) / Eje de salida (trasero) / Output shaft (rear)				6007 N	000625506007	BB
--	--	--	--	---------------	--------------	----

321 H (O) * 321 HL (O) (58...71)

Caixa de Mudanças / Caja de Cambios / Gearbox

Eixo de entrada (dianteiro) / Eje de entrada (delantero) / Input shaft (front)				30308 F		TRB
Eixo de entrada (traseiro) / Eje de entrada (trasero) / Input shaft (rear)				30309 F		TRB
				6309 Z / C3		BB
Eixo de saída (traseiro) / Eje de salida (trasero) / Output shaft (rear)				6309 Z / C3		BB
Eixo intermediário / Eje intermedio / Intermediate shaft				30309 F		TRB
				30308 F	0019813105 / 0019815005	TRB
Eixo primário / Eje primario / Primary shaft				NU 209 FMN	3449817101	CRB
				QJ 209 FM	3459817027	BB4PAC
Eixo primário (dianteiro) / Eje primario (delantero) / Primary shaft (front)				QJ 212 FM	3459817627	BB4PAC
Eixo secundário (traseiro) / Eje secundario (trasero) / Secondary shaft (rear)				QJ 309 FM	3459817127 / 3459817727	BB4PAC
				QJ 309 FM	0009813105	BB4PAC

Direção / Dirección / Steering

Alavanca (inf.) / Palanca (inf.) / Lever (lower)				30205 F	000720030205	TRB
Alavanca (sup.) / Palanca (sup.) / Lever (upper)				30206 F	000720030206	TRB

Eixo Dianteiro / Eje Delantero / Front Axle

Roda / Rueda / Wheel		•		30312 F	0019819705	TRB
	•			32307 F	0039816405	TRB

Eixo Traseiro / Eje Trasero / Rear Axle



Roda / Rueda / Wheel	•			32212 F	3129810101	TRB
		•		32214 F	3129810001	TRB
	•			32216 F		TRB
		•		32216 F	0009817205	TRB
		•		598 A / 593 X	0039811405	TRB



Embreagem / Embrague / Clutch

Apoio / Apoyo / Support				6204		BB
				6204	000625006204	BB

Motor / Motor / Engine

Bomba d'água / Bomba de agua / Water pump				30302 F	000720030202	TRB
Bomba d'água (dianteiro) / Bomba de agua (delantero) / Water pump (front)				6204	000625006204	BB
				6206	000625006206	BB
Bomba d'água - rodam / Bomba de agua - rodam. / Water pump - bearing				30302 F		TRB
Bomba d'água (traseiro) / Bomba de agua (trasero) / Water pump (rear)				6004	000625006004	BB
				NU 303 FM	0019819601	CRB

	OUT	IN		Fersa®	Nº OEM	
MERCEDES BENZ (SA)						
321 H (O) * 321 HL (O) (58...71)						
Bomba injetora (dianteiro) / Bomba inyectora (delantero) / Injection pump (front)				30203 F	000720030203	TRB
Compressor de ar / Compresor de aire / Air compressor				6305	000625006305	BB
				NJ 305 FM / C3	005412400004	CRB
Polia tensora / Polea tensora / Tensioner pulley				6302	000625006302	BB
Polia tensora (dianteiro) / Polea tensora (delantero) / Tensioner pulley (front)				30204 F	000720030204	TRB
Polia tensora (traseiro) / Polea tensora (trasero) / Tensioner pulley (rear)				30205 F	000720030205	TRB
Polia tensora - rolam. / Polea tensora - rodam. / Tensioner pulley - bearing				6302		BB
Ventilador (traseiro) / Ventilador (trasero) / Fan (rear)				6304		BB
				6304	000625006304	BB
326 O						
Caixa de Mudanças / Caja de Cambios / Gearbox						
Eixo intermediário / Eje intermedio / Intermediate shaft				30308 F	0019813105 / 0019815005	TRB
				30308 F		TRB
Eixo primário / Eje primario / Primary shaft				F 19011		CRBS
				NU 209 FMN	3449817101	CRB
				QJ 209 FM	3459817027	BB4PAC
			QJ 212 FM		BB4PAC	
Eixo primário (dianteiro) / Eje primario (delantero) / Primary shaft (front)				QJ 212 FM	3459817627	BB4PAC
Eixo secundário (traseiro) / Eje secundario (trasero) / Secondary shaft (rear)				QJ 309 FM	3459817127 / 3459817727	BB4PAC
				QJ 309 FM	0009813105	BB4PAC
Eixo Traseiro / Eje Trasero / Rear Axle						
Diferencial - coroa lateral (dir. / esq.) / Diferencial - coroa lateral (der. / izq.) / Differential - crown gear (right / left)			71...	47487 / 47420 A		TRB
Direção / Dirección / Steering						
Alavanca (inf.) / Palanca (inf.) / Lever (lower)				30205 F	000720030205	TRB
Alavanca (sup.) / Palanca (sup.) / Lever (upper)				30206 F	000720030206	TRB
Eixo Dianteiro / Eje Delantero / Front Axle						
Roda / Rueda / Wheel		•		30312 F	0019819705	TRB
	•			32307 F	0039816405	TRB
Eixo Traseiro / Eje Trasero / Rear Axle						
Roda / Rueda / Wheel	•			32212 F	3129810101	TRB
		•		32214 F	3129810001	TRB
		•		32216 F	0009817205	TRB
		•		598 A / 593 X	0039811405	TRB
Embreagem / Embrague / Clutch						
Apoio / Apoyo / Support				6205		BB
				6204	000625006204	BB
Motor / Motor / Engine						
Alternador (dianteiro) / Alternador (delantero) / Alternator (front)			71...	6403 2RS / C3		BB
Alternador (traseiro) / Alternador (trasero) / Alternator (rear)			71...	6201 2RS / C3		BB
Bomba d'água / Bomba de agua / Water pump				30302 F	000720030202	TRB

	OUT	IN		Fersa®	N° OEM	
---	-----	----	---	---------------	--------	---

MERCEDES BENZ (SA)

326 (O)

Bomba d'água (dianteiro) / Bomba de agua (delantero) / Water pump (front)				6204	000625006204	BB
				6206	000625006206	BB
Bomba d'água (traseiro) / Bomba de agua (traseiro) / Water pump (rear)				6004	000625006004	BB
				NU 303 FM	0019819601	CRB
Bomba injetora (dianteiro) / Bomba inyectora (delantero) / Injection pump (front)				30203 F	000720030203	TRB
Compressor / Compresor / Compressor			...71	6305		BB
Compressor (traseiro) / Compresor (traseiro) / Compressor (rear)			71...	NJ 305 C3		CRB
Compressor de ar / Compresor de aire / Air compressor				6305	000625006305	BB
				NJ 305 FM / C3	005412400004	CRB
Polia tensora / Polea tensora / Tensioner pulley				6302	000625006302	BB
Polia tensora (dianteiro) / Polea tensora (delantero) / Tensioner pulley (front)				30204 F	000720030204	TRB
Polia tensora (traseiro) / Polea tensora (traseiro) / Tensioner pulley (rear)				30205 F	000720030205	TRB
Ventilador (traseiro) / Ventilador (traseiro) / Fan (rear)				6304	000625006304	BB

352 HL (O) (...74)

Caixa de Mudanças / Caja de Cambios / Gearbox

Eixo intermediário / Eje intermedio / Intermediate shaft				30308 F	0019813105 / 0019815005	TRB
				30308 F		TRB
Eixo primário / Eje primario / Primary shaft				QJ 209 FM		BB4PAC
				QJ 209 FM	3459817027	BB4PAC
Eixo primário (dianteiro) / Eje primario (delantero) / Primary shaft (front)				QJ 212 FM	3459817627	BB4PAC
				QJ 309 FM	3459817127 / 3459817727	BB4PAC
Eixo primário (traseiro) / Eje primario (traseiro) / Primary shaft (rear)				NU 209 FMN	3449817101	CRB
Eixo secundário (traseiro) / Eje secundario (traseiro) / Secondary shaft (rear)				QJ 309 FM	3459817127 / 3459817727	BB4PAC

Direção / Dirección / Steering

Alavanca (inf.) / Palanca (inf.) / Lever (lower)				30205 F	000720030205	TRB
Alavanca (sup.) / Palanca (sup.) / Lever (upper)				30206 F	000720030206	TRB

Eixo Dianteiro / Eje Delantero / Front Axle



Roda / Rueda / Wheel		•		30312 F	0019819705	TRB
	•			32307 F	0039816405	TRB
		•		559 / 552 A	3449817005	TRB

Eixo Traseiro / Eje Trasero / Rear Axle

Roda / Rueda / Wheel		•		32215 F		TRB
		•		32216 F	0009817205	TRB
	•			33019 F	00298190 (77...)05 / 0039818605	TRB
	•			33215 F	0029818905 / 0029818605	TRB
		•		598 A / 593 X	0039811405	TRB

Embreagem / Embrague / Clutch

Apóio / Apoyo / Support				6204	000625006204	BB
-------------------------	--	--	--	-------------	--------------	----

	OUT	IN		Fersa®	Nº OEM	
MERCEDES BENZ (SA)						
352 HL (O) (...74)						
Apoio / Apoyo / Support				6204 2RS	000625406204	BB
				6205 2RS	000625406205	BB
Motor / Motor / Engine						
Alternador (dianteiro) / Alternador (delantero) / Alternator (front)				6403 2RS / C3	0049812425	BB
Alternador (traseiro) / Alternador (trasero) / Alternator (rear)				6201 2RS / C3	0049812425	BB
				62201 2RS / C3	000625406303	BB
Bomba d'água (dianteiro) / Bomba de agua (delantero) / Water pump (front)				6203	000625900208	BB
Bomba d'água (traseiro) / Bomba de agua (trasero) / Water pump (rear)				6206	000625006206	BB
				NU 303 FM	0019819601	CRB
Bomba hidráulica / Bomba hidráulica / Hydraulic pump				62204 2RS	0049819625	BB
Bomba injetora (dianteiro) / Bomba inyectora (delantero) / Injection pump (front)				30203 F	000720030203	TRB
Bomba injetora (traseiro) / Bomba inyectora (trasero) / Injection pump (rear)				30204 F	000720030204	TRB
Virabrequim / Cigüeñal / Crankshaft				6204 2RS / C3	000625406204	BB
Compressor de ar / Compresor de aire / Air compressor				NJ 305 FM / C3	005412400004	CRB
Polia tensora / Polea tensora / Tensioner pulley				6302	000625006302	BB
Ventilador (dianteiro) / Ventilador (delantero) / Fan (front)				6304 C3	000625006304	BB
355 O						
Caixa de Mudanças / Caja de Cambios / Gearbox						
Eixo intermediário / Eje intermedio / Intermediate shaft				30308 F	0019813105 / 0019815005	TRB
Eixo primário / Eje primario / Primary shaft				QJ 209 FM	3459817027	BB4PAC
Eixo primário (dianteiro) / Eje primario (delantero) / Primary shaft (front)				QJ 212 FM	3459817627	BB4PAC
				QJ 309 FM	3459817127 / 3459817727	BB4PAC
Eixo primário (traseiro) / Eje primario (trasero) / Primary shaft (rear)				NU 209 FMN	3449817101	CRB
Eixo secundário (traseiro) / Eje secundario (trasero) / Secondary shaft (rear)				QJ 309 FM	3459817127 / 3459817727	BB4PAC
Direção / Dirección / Steering						
Alavanca (inf.) / Palanca (inf.) / Lever (lower)				30205 F	000720030205	TRB
Alavanca (sup.) / Palanca (sup.) / Lever (upper)				30206 F	000720030206	TRB
Eixo Dianteiro / Eje Delantero / Front Axle						
Roda / Rueda / Wheel		•		30312 F	0019819705	TRB
	•			32307 F	0039816405	TRB
		•		559 / 552 A	3449817005	TRB
Eixo Traseiro / Eje Trasero / Rear Axle						
Roda / Rueda / Wheel		•		32216 F	0009817205	TRB
	•			33019 F	00298190 (77...)05 / 0039818605	TRB
	•			33215 F	0029818905 / 0029818605	TRB
		•		598 A / 593 X	0039811405	TRB
Embreagem / Embrague / Clutch						
Apoio / Apoyo / Support				6204	000625006204	BB
				6204 2RS	000625406204	BB

	OUT	IN		Fersa®	N° OEM	
---	-----	----	---	---------------	--------	---

MERCEDES BENZ (SA)

355 O

Apoio / Apoyo / Support				6205 2RS	000625406205	BB
Motor / Motor / Engine						
Alternador (dianteiro) / Alternador (delantero) / Alternator (front)				6403 2RS / C3	0049812425	BB
Alternador (traseiro) / Alternador (trasero) / Alternator (rear)				6201 2RS / C3	0049812425	BB
				62201 2RS / C3	000625406303	BB
Bomba d'água (dianteiro) / Bomba de agua (delantero) / Water pump (front)				6203	000625900208	BB
Bomba d'água (traseiro) / Bomba de agua (trasero) / Water pump (rear)				6206	000625006206	BB
				NU 303 FM	0019819601	CRB
Bomba hidráulica / Bomba hidráulica / Hydraulic pump				62204 2RS	0049819625	BB
Bomba injetora (dianteiro) / Bomba inyectora (delantero) / Injection pump (front)				30203 F	000720030203	TRB
Bomba injetora (traseiro) / Bomba inyectora (trasero) / Injection pump (rear)				30204 F	000720030204	TRB
Virabrequim / Cigüeñal / Crankshaft				6204 2RS / C3	000625406204	BB
Compressor de ar / Compresor de aire / Air compressor				NJ 305 FM / C3	005412400004	CRB
Polia tensora / Polea tensora / Tensioner pulley				6302	000625006302	BB
Ventilador (dianteiro) / Ventilador (delantero) / Fan (front)				6304 C3	000625006304	BB

355 HL (O) (...74)

Caixa de Mudanças / Caja de Cambios / Gearbox

Eixo secundário (traseiro) / Eje secundario (trasero) / Secondary shaft (rear)				QJ 309 FM		BB4PAC
--	--	--	--	------------------	--	--------

Direção / Dirección / Steering

Alavanca intermediária (inf.) / Palanca intermedia (inf.) / Intermediate lever (lower)				30205 F		TRB
Alavanca intermediária (sup.) / Palanca intermedia (sup.) / Intermediate lever (upper)				30206 F		TRB

362 O

Caixa de Mudanças / Caja de Cambios / Gearbox

Eixo intermediário / Eje intermedio / Intermediate shaft				30308 F	0019813105 / 0019815005	TRB
			713301 / 407	30308 F		TRB
Eixo primário (dianteiro) / Eje primario (delantero) / Primary shaft (front)			713407	QJ 209 FM		BB4PAC
				QJ 212 FM	3459817627	BB4PAC
				QJ 309 FM	3459817127 / 3459817727	BB4PAC
Eixo primário (traseiro) / Eje primario (trasero) / Primary shaft (rear)			713301	F 19011		CRBS
				NU 209 FMN	3449817101	CRB
Eixo secundário (traseiro) / Eje secundario (trasero) / Secondary shaft (rear)			713301 / 407	QJ 309 FM		BB4PAC
				QJ 309 FM	3459817127 / 3459817727	BB4PAC

Eixo Traseiro / Eje Trasero / Rear Axle

Diferencial - coroa lateral (dir. / esq.) / Diferencial - corona lateral (der. / izq.) / Differential - crown gear (right / left)			321423 / 24 / 26 / 427	47487 / 47420 A		TRB
---	--	--	------------------------	------------------------	--	-----

Direção / Dirección / Steering

Alavanca (inf.) / Palanca (inf.) / Lever (lower)				30205 F	000720030205	TRB
Alavanca (sup.) / Palanca (sup.) / Lever (upper)				30206 F	000720030206	TRB

	OUT	IN		Fersa®	Nº OEM	
---	-----	----	---	---------------	--------	---

MERCEDES BENZ (SA)

362 O

Eixo Dianteiro / Eje Delantero / Front Axle

Roda / Rueda / Wheel		•		559 / 552 A	3449817005	TRB
----------------------	--	---	--	--------------------	------------	-----

Eixo Traseiro / Eje Trasero / Rear Axle

Roda / Rueda / Wheel	•			33019 F	00298190 (77...)05 / 0039818605	TRB
	•			33215 F	0029818905 / 0029818605	TRB
		•		598 A / 593 X	0039811405	TRB

Embreagem / Embrague / Clutch

Apoio / Apoyo / Support				6204 2RS	000625406204	BB
				6205 2RS	000625406205	BB

Motor / Motor / Engine

Alternador (dianteiro) / Alternador (delantero) / Alternator (front)				6403 C3	0049812425	BB
Alternador (traseiro) / Alternador (trasero) / Alternator (rear)				62201 2RS / C3	000625406303	BB
Bomba d'água (dianteiro) / Bomba de agua (delantero) / Water pump (front)				6206	000625006206	BB
Bomba d'água (traseiro) / Bomba de agua (trasero) / Water pump (rear)				6203	000625900208	BB
				NU 303 FM	0019819601	CRB
Bomba hidráulica / Bomba hidráulica / Hydraulic pump				62204 2RS	0049819625	BB
Bomba injetora (dianteiro) / Bomba inyectora (delantero) / Injection pump (front)				30203 F	000720030203	TRB
Bomba injetora (traseiro) / Bomba inyectora (trasero) / Injection pump (rear)				30204 F	000720030204	TRB
Virabrequim / Cigüeñal / Crankshaft				6204 2RS / C3	000625406204	BB
Compressor (dianteiro) / Compresor (delantero) / Compressor (front)			345932	NJ 305 C3		CRB
Compressor de ar / Compresor de aire / Air compressor				NJ 305 FM / C3	005412400004	CRB
Polia tensora / Polea tensora / Tensioner pulley				6302	000635006302	BB
Ventilador (traseiro) / Ventilador (trasero) / Fan (rear)				6304 C3	000635006303	BB

364 O

Caixa de Mudanças / Caja de Cambios / Gearbox

Eixo de saída (traseiro) / Eje de salida (trasero) / Output shaft (rear)			713301 / 401 / 511 / 530	QJ 309 FM		BB4PAC
Eixo intermediário / Eje intermedio / Intermediate shaft				30308 F	0019813105 / 0019815005	TRB
Eixo primário (dianteiro) / Eje primario (delantero) / Primary shaft (front)			713401	QJ 209 FM		BB4PAC
			713301 / 511 / 530	QJ 212 FM		BB4PAC
				QJ 212 FM	3459817627	BB4PAC
				QJ 309 FM	3459817127 / 3459817727	BB4PAC
Eixo primário (traseiro) / Eje primario (trasero) / Primary shaft (rear)			713301 / 511 / 530	F 19011		CRBS
				NU 209 FMN	3449817101	CRB
Eixo secundário (traseiro) / Eje secundario (trasero) / Secondary shaft (rear)				QJ 309 FM	3459817127 / 3459817727	BB4PAC

Eixo Traseiro / Eje Trasero / Rear Axle

Diferencial - coroa lateral (dir. / esq.) / Diferencial - corona lateral (der. / izq.) / Differential - crown gear (right / left)			743206 / 230 / 231 / 232 / 297 / 299	47487 / 47420 A		TRB
---	--	--	--------------------------------------	------------------------	--	-----

	OUT	IN		Fersa®	N° OEM	
---	-----	----	---	---------------	--------	---

MERCEDES BENZ (SA)

364 O

Direção / Dirección / Steering

Alavanca (inf.) / Palanca (inf.) / Lever (lower)				30205 F	000720030205	TRB
Alavanca (sup.) / Palanca (sup.) / Lever (upper)				30206 F	000720030206	TRB

Eixo Dianteiro / Eje Delantero / Front Axle

Roda / Rueda / Wheel		•		33019 F		TRB
	•			33215 F		TRB
		•		559 / 552 A	3449817005	TRB

Eixo Traseiro / Eje Trasero / Rear Axle

Roda / Rueda / Wheel	•			33019 F	00298190 (77...)05 / 0039818605	TRB
	•			33215 F	0029818905 / 0029818605	TRB
		•		598 A / 593 X	0039811405	TRB

Embreagem / Embrague / Clutch

Apio / Apoyo / Support			344944	6204 2RS	000625406204	BB
			345936 / 945 / 946	6205 2RS	000625406205	BB

Motor / Motor / Engine

Alternador (dianteiro) / Alternador (delantero) / Alternator (front)				6403 C3	0049812425	BB
Alternador (traseiro) / Alternador (trasero) / Alternator (rear)				62201 2RS / C3	000625406303	BB
Bomba d'água (dianteiro) / Bomba de agua (delantero) / Water pump (front)				6206	000625006206	BB
Bomba d'água (traseiro) / Bomba de agua (trasero) / Water pump (rear)				6203	000625900208	BB
				NU 303 FM	0019819601	CRB
Bomba hidráulica / Bomba hidráulica / Hydraulic pump				62204 2RS	0049819625	BB
Bomba injetora (dianteiro) / Bomba inyectora (delantero) / Injection pump (front)				30203 F	000720030203	TRB
Bomba injetora (traseiro) / Bomba inyectora (trasero) / Injection pump (rear)				30204 F	000720030204	TRB
Virabrequim / Cigüeñal / Crankshaft				6204 2RS / C3	000625406204	BB
Compressor (dianteiro) / Compresor (delantero) / Compressor (front)			345936 / 945 / 946	NJ 305 C3		CRB
Compressor de ar / Compresor de aire / Air compressor				NJ 305 FM / C3	005412400004	CRB
Polia tensora / Polea tensora / Tensioner pulley				6302	000635006302	BB
Polia tensora - rolam. / Polea tensora - rodam. / Tensioner pulley - bearing			364101 / 152	6303		BB
Ventilador (traseiro) / Ventilador (trasero) / Fan (rear)				6304 C3	000635006303	BB

364 HL (O) (...74)

Motor / Motor / Engine

Alternador (traseiro) / Alternador (trasero) / Alternator (rear)			70...	6201 2RS / C3		BB
Bomba d'água (dianteiro) / Bomba de agua (delantero) / Water pump (front)				6203		BB
Bomba d'água (traseiro) / Bomba de agua (trasero) / Water pump (rear)				6206		BB
Polia tensora - rolam. / Polea tensora - rodam. / Tensioner pulley - bearing				6302		BB
Ventilador (dianteiro) / Ventilador (delantero) / Fan (front)				6304		BB

370 * 371 (RS * RSD * RST * ST * U * UP) (O)

Caixa de Mudanças / Caja de Cambios / Gearbox

Eixo intermediário (dianteiro) / Eje intermedio (delantero) / Intermediate shaft (front)				F 15047		TRBS
--	--	--	--	----------------	--	------

	OUT	IN		Fersa®	Nº OEM	
---	-----	----	---	---------------	--------	---

MERCEDES BENZ (SA)

370 * 371 (RS*RSD*RST*ST*U*UP) (O)

Eixo intermediário (dianteiro / traseiro) / Eje Intermedio (delantero / trasero) / Intermediate shaft (front / rear)				30308 F	0019813105 / 0019815005	TRB
Eixo intermediário (traseiro) / Eje intermedio (trasero) / Intermediate shaft (rear)				32309 F	0049811305	TRB
Eixo primário (dianteiro) / Eje primario (delantero) / Primary shaft (front)				QJ 212 FM	3459817627	BB4PAC
Eixo primário (traseiro) / Eje primario (trasero) / Primary shaft (rear)			G 3 / 60-5 / 7,5 * G 3 / 61-5 / 6,1	F 19011		CRBS
Eixo secundário (traseiro) / Eje secundario (trasero) / Secondary shaft (rear)			718250	6314 C3		BB
				QJ 309 FM	3459817127 / 3459817727	BB4PAC

Eixo Traseiro / Eje Trasero / Rear Axle

Diferencial - coroa lateral (dir. / esq.) / Diferencial - corona lateral (der. / izq.) / Differential - crown gear (right / left)				32018 XF		TRB
			HO 7 / 01 DL-10 * HO 7 / 01 DL-10 / 4,64	33115 F		TRB
			HO 4 / 23D-10 / 43:7 * HO 4 / 23D-10 / 42:8 * HO 4 / 23DL-10 / 42:8	47487 / 47420 A		TRB
Diferencial - pinhão (dianteiro) / Diferencial - piñón (delantero) / Differential - pinion (front)			HO 7 / 01 DL-10 * HO 7 / 01 DL-10 / 4,64	31313 F		TRB
Diferencial - pinhão (traseiro) / Diferencial - piñón (trasero) / Differential - pinion (rear)			HO 7 / 01 DL-10 * HO 7 / 01 DL-10 / 4,64	32314 BF		TRB

Direção / Dirección / Steering

Inferior / Inferior / Lower				30205 F	000720030205	TRB
Braço superior / Brazo superior / Upper arm				30206 F	000720030206	TRB

Eixo Dianteiro / Eje Delantero / Front Axle

Roda / Rueda / Wheel	•			32310 F	0019817405	TRB
		•		F 15051 C	0059813105	TRBS

Eixo Traseiro / Eje Trasero / Rear Axle



Roda / Rueda / Wheel	•			32019 XF	0029815405	TRB
	•			32310 F	0019817405	TRB
		•		33019 F	00298190 (77...)05 / 0039818605	TRB
		•		33020 F	0059818505	TRB
		•		33021 F	0039812605	TRB
		•		33022 F	0049810905	TRB
	•			33117 F	0059818605	TRB
	•			33215 F	0029818905 / 0029818605	TRB
	•		F 15051 C	0059813105	TRBS	

Embreagem / Embrague / Clutch

Apoio / Apoyo / Support			345937 / 949 / 952 / 960 / 972 / 974 / 975 / 976	6205 2RS		BB
				6205 2RS	000625406205	BB

Motor / Motor / Engine

Alternador (dianteiro) / Alternador (delantero) / Alternator (front)				6303 2RS / C3	000625406303	BB
Alternador (traseiro) / Alternador (trasero) / Alternator (rear)				62201 2RS / C3	00298190 (77...)25	BB
Avanço automático / Avance automático / Automatic advance				30203 F	000720030203	TRB
				30204 F	000720030204	TRB

	OUT	IN		Fersa®	Nº OEM	
---	-----	----	---	---------------	--------	---

MERCEDES BENZ (SA)

370 * 371 (RS*RSD*RST*ST*U*UP) (O)

Bomba d'água (dianteiro) / Bomba de agua (delantero) / Water pump (front)				6206 C3	000625006206	BB
Bomba d'água (traseiro) / Bomba de agua (traseiro) / Water pump (rear)				6203 C3	000625900208	BB
				NU 303 FMN	0019819601	CRB
Bomba injetora (dianteiro) / Bomba inyectora (delantero) / Injection pump (front)				30204 F	000720030204	TRB
Bomba injetora (dianteiro / traseiro) / Bomba inyectora (delantero / traseiro) / Injection pump (front / rear)				30203 F	000720030203	TRB
				32205 F	000720032205	TRB
Virabrequim / Cigüeñal / Crankshaft				6204 2RS	000625406204	BB
				6205 2RS	000625406205	BB
Compressor de ar / Compresor de aire / Air compressor				NJ 305 FM C3	005412400004	CRB
Polia tensora / Polea tensora / Tensioner pulley				6304 C3	3449817025	BB
Ventilador (dianteiro) / Ventilador (delantero) / Fan (front)				NUP 304 FM	005412600304	CRB
Ventilador (traseiro) / Ventilador (traseiro) / Fan (rear)				6304 C3	3449817025	BB
Virabrequim - ponta / Cigüeñal - punta / Crankshaft spindle			OM 366 G / A / LA * OM 366 * OM 355 A	6204 2RS		BB
			OM 355 / 5	6205 2RS		BB

400 (R*RS*RSD*RSL) (O)

Caixa de Mudanças / Caja de Cambios / Gearbox

Eixo de acionamento / Eje de accionamiento / Drive shaft				NUP 314 FM / C3	0019819802	CRB
Eixo intermediário (dianteiro) / Eje intermedio (delantero) / Intermediate shaft (front)			S 6-90 / 6,98 * S 6-1550 / 6,98	F 15047		TRBS
				NUP 314 FM / C3	0019819802	CRB
Eixo intermediário (saída) / Eje intermedio (salida) / Intermediate shaft (output)				32309 F	0049811305	TRB
Eixo intermediário (traseiro) / Eje intermedio (traseiro) / Intermediate shaft (rear)				32309 F	0049811305	TRB
Eixo primário / Eje primario / Primary shaft			S 6-90 / 6,98 * S 6-1550 / 6,98	NUP 314 FMNR / C3	0019819802	CRB
Eixo principal (saída) / Eje principal (salida) / Main shaft (output)				NUP 314 FM / C3	0019819802	CRB
Eixo secundário (traseiro) / Eje secundario (traseiro) / Secondary shaft (rear)			S 6-90 / 6,98 * S 6-1550 / 6,98	NUP 314 FMNR / C3		CRB

Direção / Dirección / Steering

Mancal - alavanca interna (inf.) / Cojinete palanca interna (inf.) / Bearing inner lever lower			O 400 R / RS / RSD / RSL	30205 F		TRB
Mancal - alavanca interna (sup.) / Cojinete palanca interna (sup.) / Bearing inner lever (upper)			O 400 R / RS / RSD / RSL	30206 F		TRB

Eixo Dianteiro / Eje Delantero / Front Axle

Roda / Rueda / Wheel	•			32310 F	0019817405	TRB
		•		F 15051 C	0059813105	TRBS

Eixo Traseiro / Eje Trasero / Rear Axle

Roda / Rueda / Wheel		•		32019 XF	0029815405	TRB
		•		33020 F	0059818505	TRB
	•			33020 F	0059818505	TRB
	•			33021 F	0039812805	TRB
	•			33116 F	012 981 4005	TRB
		•		33117 F	0059818605	TRB
	•			33117 F	0059818605	TRB

	OUT	IN		Fersa®	N° OEM	
---	-----	----	---	---------------	--------	---

MERCEDES BENZ (SA)

400 (R*RS*RSD*RSL) (O)

Motor / Motor / Engine

Alternador (dianteiro) / Alternador (delantero) / Alternator (front)				6303 2RS / C3	000625406303	BB
Alternador (traseiro) / Alternador (trasero) / Alternator (rear)			O 447 LA	62201 2RS / C3	00298190 (77...)25	BB
Ventilador / Ventilador / Fan			O 400 R / RS / RSD / RSL	6004 Z		BB

500 (O*M*R)

Caixa de Mudanças / Caja de Cambios / Gearbox

Eixo de acionamento / Eje de accionamiento / Drive shaft				NUP 314 FM / C3	0019819802	CRB
Eixo intermediário (dianteiro) / Eje intermedio (delantero) / Intermediate shaft (front)				NUP 314 FM / C3	0019819802	CRB
Eixo intermediário (saída) / Eje intermedio (salida) / Intermediate shaft (output)				32309 F	0049811305	TRB
Eixo intermediário (traseiro) / Eje intermedio (trasero) / Intermediate shaft (rear)				32309 F	0049811305	TRB
Eixo primário / Eje primario / Primary shaft				NUP 314 FM / C3	0019819802	CRB
Eixo principal (saída) / Eje principal (salida) / Main shaft (output)				NUP 314 FM / C3	0019819802	CRB

Eixo Dianteiro / Eje Delantero / Front Axle

Roda / Rueda / Wheel	•			32310 F	0019817405	TRB
		•		F 15051 C	0059813105	TRBS

Eixo Traseiro / Eje Trasero / Rear Axle

Roda / Rueda / Wheel		•		32019 XF	0029815405	TRB
		•		33020 F	0059818505	TRB
	•			33020 F	0059818505	TRB
	•			33021 F	0039812805	TRB
	•			33116 F	012 981 4005	TRB
		•		33117 F	0059818605	TRB
	•			33117 F	0059818605	TRB

Motor / Motor / Engine

Alternador (dianteiro) / Alternador (delantero) / Alternator (front)				6303 2RS / C3	000625406303	BB
Alternador (traseiro) / Alternador (trasero) / Alternator (rear)				62201 2RS / C3	00298190 (77...)25	BB

608 D * E (L*LO) * 708 D * E (L*LO) * 709 L * 710 L * 712 L

Caixa de Mudanças / Caja de Cambios / Gearbox

Eixo intermediário (dianteiro / traseiro) / Eje Intermedio (delantero / trasero) / Intermediate shaft (front / rear)				30306 F	0019815705	TRB
				30308 F	0019813105 / 0019815005	TRB
Eixo primário (dianteiro) / Eje primario (delantero) / Primary shaft (front)				QJ 208 FM	0009813427	BB4PAC
				QJ 212 FM	3459817627	BB4PAC
Eixo primário (traseiro) / Eje primario (trasero) / Primary shaft (rear)				NU 208 FM	3459817101	CRB
Eixo principal (entrada / saída) / Eje principal (entrada / salida) / Main shaft (input / output)				32210 F	A0159815005	TRB
Eixo secundário (dianteiro) / Eje secundario (delantero) / Secondary shaft (front)				QJ 208 FM	0009813427	BB4PAC
				QJ 309 FM	3459817127 / 3459817727	BB4PAC

	OUT	IN		Fersa®	Nº OEM	
---	-----	----	---	---------------	--------	---

MERCEDES BENZ (SA)

608 D * E (L*LO) * 708 D * E (L*LO) * 709 L * 710 L * 712 L

Eixo secundário (traseiro) / Eje secundario (trasero) / Secondary shaft (rear)				NU 208 FM	3459817101	CRB
			712100	QJ 208 FM		BB4PAC
			G 3 / 60-5 / 7,5	QJ 309 FM		BB4PAC

Eixo Dianteiro / Eje Delantero / Front Axle

Roda / Rueda / Wheel	•			32306 F	0019818705	TRB
		•		33109 F	0039811605	TRB
		•		33111 F	0069807205 / 0009807502	TRB
	•			33205 F	6889817005	TRB

Eixo Traseiro / Eje Trasero / Rear Axle

Roda / Rueda / Wheel	•			33011 F	0029819305	TRB
		•		33895 / 33822	0029810505	TRB
		•	HL 2 / 5-4,5 / 43:10 * HL 2 / 16-4,7 / 43:10 * HL 2 / 16-4,7 / 40:11	3984 / 3920		TRB

Motor / Motor / Engine

Alternador (dianteiro) / Alternador (delantero) / Alternator (front)				6303 2RS / C3	000625406303	BB
				6303 ZZ / C3	000625900182	BB
				6303 ZZ / C3	000625900193	BB
Alternador (traseiro) / Alternador (trasero) / Alternator (rear)				62201 2RS / C3	00298190 (77...)95	BB
Bomba d'água (dianteiro) / Bomba de agua (delantero) / Water pump (front)				6203	000625006203	BB
Bomba d'água (traseiro) / Bomba de agua (trasero) / Water pump (rear)				6206	000625006206	BB
Bomba hidráulica / Bomba hidráulica / Hydraulic pump				62204 2RS	0049819625	BB
Bomba injetora (dianteiro) / Bomba inyectora (delantero) / Injection pump (front)				30203 F	000720030203	TRB
Bomba injetora (traseiro) / Bomba inyectora (trasero) / Injection pump (rear)				30204 F	000720030204	TRB
Virabrequim / Cigüeñal / Crankshaft				6204 2RS / C3	000625406204	BB
Virabrequim - ponta / Cigüeñal - punta / Crankshaft spindle			OM 364 A * OM 314 I	6204 2RS		BB

Tomada de Potência / Toma de Potencia / Power Take-off

Eixo intermediário (dianteiro) / Eje intermedio (delantero) / Intermediate shaft (front)				NJ 304 FMN	005412400304	CRB
Eixo primário (dianteiro) / Eje primario (delantero) / Primary shaft (front)				32304 F	00198190 (77...)05	TRB
Eixo primário (traseiro) / Eje primario (trasero) / Primary shaft (rear)				32306 F	3129810205	TRB
Eixo secundário (dianteiro) / Eje secundario (delantero) / Secondary shaft (front)				32305 F	007200032305	TRB
Eixo secundário (traseiro) / Eje secundario (trasero) / Secondary shaft (rear)				32306 F	3129810205	TRB

812 LO * 912 L

Caixa de Mudanças / Caja de Cambios / Gearbox

Eixo intermediário (dianteiro / traseiro) / Eje Intermedio (delantero / trasero) / Intermediate shaft (front / rear)			G 3 / 60-5 / 7,5 * G 3 / 50-5 / 8,5	30308 F		TRB
Eixo secundário (dianteiro) / Eje secundario (delantero) / Secondary shaft (front)			G 3 / 60-5 / 7,5 * G 3 / 50-5 / 8,5	32211 F		TRB
Eixo secundário (traseiro) / Eje secundario (trasero) / Secondary shaft (rear)			G 3 / 60-5 / 7,5 * G 3 / 50-5 / 8,5	QJ 309 FM		BB4PAC

	OUT	IN		Fersa [®]	N° OEM	
---	-----	----	---	---------------------------	--------	---

MERCEDES BENZ (NA)

Multego IBC 1842 * IBC 2242 * OC 500

Caixa de Mudanças / Caja de Cambios / Gearbox

		ZF 105	F 15047	073 537 00 55	TRBS
		ZF 105	NUP 314 FMNR / C3	001 981 98 02	CRB
			32309 F	004 981 13 05	TRB

Eixo Traseiro / Eje Trasero / Rear Axle

Diferencial / Diferencial / Differential			32020 XF	001 981 64 05	TRB
Diferencial - eixo (traseiro) / Diferencial - eje (trasero) / Differential - shaft (rear)			F 15159	006 981 35 05	TRBS
Diferencial (dir. / esq.) / Diferencial (der. / izq.) / Differential (right / left)			32018 XF	004 981 43 05	TRB
Diferencial - pinhão / Diferencial - piñón / Differential - pinion			F 19013	007 981 79 01	CRBS
Diferencial - pinhão cabeça / Diferencial - piñón cabeça / Differential - pinion head			30313 F	072 003 03 13	TRB

Eixo Dianteiro / Eje Delantero / Front Axle

Roda / Rueda / Wheel	•		MB VO4 / 13 DL7 / 16,600 lb.	32310 F	001 981 74 05	TRB
		•	MB VO4 / 13 DL7 16,600	F 15051 C	005 981 30 05	TRBS

Eixo Traseiro / Eje Trasero / Rear Axle

Espiga cônica / Espiga cónica / Rear shaft	•			33117 F	001 980 67 02	TRB
		•		33020 F	005 981 84 05	TRB

O 355

Eixo Traseiro / Eje Trasero / Rear Axle

Diferencial - eixo (traseiro) / Diferencial - eje (trasero) / Differential - shaft (rear)				32212 F	3129810101	TRB
---	--	--	--	----------------	------------	-----

Eixo Dianteiro / Eje Delantero / Front Axle

Roda / Rueda / Wheel				30312 F	001 981 97 05	TRB
				559 / 552 A	3449817005	TRB

Eixo Traseiro / Eje Trasero / Rear Axle

Roda / Rueda / Wheel				598 A / 593 X	0039811405	TRB
				32214 F	3129810001	TRB

O371R * O371RS * O371RSD

Caixa de Mudanças / Caja de Cambios / Gearbox



		ZF 105	F 15047	073 537 00 55	TRBS
		ZF 105	NUP 314 FMNR / C3	001 981 98 02	CRB
		ZF 105	32309 F	004 981 13 05	TRB

Eixo Traseiro / Eje Trasero / Rear Axle

Diferencial / Diferencial / Differential			32020 XF	001 981 64 05	TRB
Diferencial - eixo (traseiro) / Diferencial - eje (trasero) / Differential - shaft (rear)			F 15159	006 981 35 05	TRBS
Diferencial (dir. / esq.) / Diferencial (der. / izq.) / Differential (right / left)			32018 XF	004 981 43 05	TRB
Diferencial - pinhão / Diferencial - piñón / Differential - pinion			F 19013	007 981 79 01	CRBS
Diferencial - pinhão cabeça / Diferencial - piñón cabeça / Differential - pinion head			30313 F	072 003 03 13	TRB

Direção / Dirección / Steering

Alavanca (sup. e inf.) / Palanca (sup. e inf.) / Lever (upper / lower)			30206 F	072 003 02 06	TRB
--	--	--	----------------	---------------	-----

	OUT	IN		Fersa®	Nº OEM	
---	-----	----	---	---------------	--------	---

MERCEDES BENZ (NA)

O 371 R * O 371 RS * O 371 RSD

Eixo Dianteiro / Eje Delantero / Front Axle

Roda / Rueda / Wheel	•			32310 F	001 981 74 05	TRB
		•		F 15051 C	005 981 30 05	TRBS

Eixo Traseiro / Eje Trasero / Rear Axle

Roda / Rueda / Wheel	•			33117 F	001 980 67 02	TRB
		•		33020 F	005 981 84 05	TRB

Motor / Motor / Engine

Bomba injetora y ventilador / Bomba de inyección y ventilador / Injection pump & fan				30204 F	072 003 02 04	TRB
--	--	--	--	----------------	---------------	-----

O 400 R * O 400 RS * O 400 RSD * O 400 RSE * O 400 RSL * MP 105 * MP 108 DD * MP 120 * MP 180 DD MP120 * MP 180 DD

Caixa de Mudanças / Caja de Cambios / Gearbox

			ZF 105	F 15047	073 537 00 55	TRBS
			ZF 105	NUP 314 FMNR / C3	001 981 98 02	CRB
			ZF 105	32309 F	004 981 13 05	TRB

Eixo Traseiro / Eje Trasero / Rear Axle

Diferencial - eixo (traseiro) / Diferencial - eje (trasero) / Differential - shaft (rear)				F 15159	006 981 35 05	TRBS
Diferencial (dir. / esq.) / Diferencial (der. / izq.) / Differential (right / left)				32018 XF	004 981 43 05	TRB
Diferencial - pinhão / Diferencial - piñón / Differential - pinion				F 19013	007 981 79 01	CRBS
Diferencial - pinhão cabeça / Diferencial - piñón cabeça / Differential - pinion head				30313 F	072 003 03 13	TRB

Eixo Dianteiro / Eje Delantero / Front Axle

Roda / Rueda / Wheel		•		F 15051 C	005 981 30 05	TRBS
	•			32310 F	001 981 74 05	TRB

Eixo Traseiro / Eje Trasero / Rear Axle

Roda / Rueda / Wheel	•			33117 F	001 980 67 02	TRB
		•		33020 F	005 981 84 05	TRB

O 500 M 1728 * O 500 R 1735

Caixa de Mudanças / Caja de Cambios / Gearbox

			Fuller FS 8406 A No. Fuller 1313645 / 791943	25590 / 25522	B7T1201A / E7HZ7K228A	TRB
			Fuller FS 8406 A No. Fuller 658981 / 660181	3782 / 3720	B5QM1216A / 9N4222	TRB
			Fuller FS 8406 A No. Fuller 675250 / 742259	39590 / 39520	2986843	TRB
			Fuller FS 8406 A	31594 / 31520	477080	TRB

Eixo Traseiro / Eje Trasero / Rear Axle

Diferencial / Diferencial / Differential				32314 BF	003 981 31 05	TRB
Diferencial - eixo (dianteiro) / Diferencial - eje (delantero) / Differential - axle (front)				31313 F	003 981 06 05	TRB
Diferencial - eixo (traseiro) / Diferencial - eje (trasero) / Differential - shaft (rear)				32018 XF	004 981 43 05	TRB
				F 15159	006 981 35 05	TRBS

Eixo Dianteiro / Eje Delantero / Front Axle

Roda / Rueda / Wheel		•	MBV04 / 13DL-7	F 15051 C	005 981 30 05	TRBS
	•		MBV04 / 13DL-7	32310 F	001 981 74 05	TRB

	OUT	IN		Fersa [®]	N° OEM	
---	-----	----	---	---------------------------	--------	---

MERCEDES BENZ (NA)

O 500 M 1728 * O 500 R 1735

Eixo Traseiro / Eje Trasero / Rear Axle

Roda / Rueda / Wheel	•			33116 F	A 012 981 40 05	TRB
		•		33020 F	005 981 84 05	TRB

OH 1417 * OH 1418

Caixa de Mudanças / Caja de Cambios / Gearbox

				32208 F	LA5113	TRB
				2789 / 2720	501398228	TRB

Eixo Traseiro / Eje Trasero / Rear Axle

Diferencial - eixo (traseiro) / Diferencial - eje (trasero) / Differential - shaft (rear)				32017 XF	184623	TRB
				32018 XF	004 981 43 05	TRB
				32020 XF	001 981 64 05	TRB
				F 15082	001 981 99 05	TRBS
Diferencial (dir.) / Diferencial (der.) / Differential (right)				497 / 493	7451380	TRB
Diferencial (esq.) / Diferencial (izq.) / Differential (left)				598 A / 592 A		TRB
Diferencial - pinhão (cabeza - cola) / Diferencial - piñón (cabeza / cola) / Differential - pinion head (rear)				55200 C / 55437		TRB

Eixo Dianteiro / Eje Delantero / Front Axle

Roda / Rueda / Wheel	•			3782 / 3720	B5QM1216A / 9N4222	TRB
		•		HM 212049 / 11		TRB

Eixo Traseiro / Eje Trasero / Rear Axle

Roda / Rueda / Wheel	•			39590 / 39520	2986843	TRB
		•		47686 / 47620	7EQH1238	TRB

OMC 1628 58 Andare

Caixa de Mudanças / Caja de Cambios / Gearbox

			Fuller FS 8406 A No. Fuller 1313645 / 791943	25590 / 25522	B7T1201A / E7HZ7K228A	TRB
			Fuller FS 8406 A No. Fuller 658981 / 660181	3782 / 3720	B5QM1216A / 9N4222	TRB
			Fuller FS 8406 A No. Fuller 675250 / 742259	39590 / 39520	2986843	TRB
			Fuller FS 8406 A No. Fuller 710787	31594 / 31520	477080	TRB

Eixo Dianteiro / Eje Delantero / Front Axle

Roda / Rueda / Wheel	•		Rockwell Dirona FF-945, 13,200 lb.	3782 / 3720	B5QM1216A / 9N4222	TRB
		•	Rockwell Dirona FF-945, 13,200 lb.	HM 212049 / HM 212011		TRB

Eixo Traseiro / Eje Trasero / Rear Axle

Roda / Rueda / Wheel	•		Rockwell RS 23-158, 23,000 LB.	580 / 572	600704011	TRB
		•	Rockwell RS 23-158, 23,000 LB.	594 A / 592 A	183704	TRB



	OUT	IN		Fersa [®]	Nº OEM	
---	-----	----	---	---------------------------	--------	---

MERCEDES BENZ (CA)

O 1835

Eixo Traseiro / Eje Trasero / Rear Axle

Diferencial - eixo (traseiro) / Diferencial - eje (trasero) / Differential - shaft (rear)				32017 XF	184623	TRB
				32020 XF	001 981 64 05	TRB

O 362HL

Eixo Traseiro / Eje Trasero / Rear Axle

Diferencial / Diferencial / Differential				32314 BF	003 981 31 05	TRB
--	--	--	--	-----------------	---------------	-----

O 370 R * O 370 RS * O 370 RSD

Caixa de Mudanças / Caja de Cambios / Gearbox

				30206 F	072 003 02 06	TRB
--	--	--	--	----------------	---------------	-----

Direção / Dirección / Steering

Suporte inferior / Soporte inferior / Lower support				30205 F	072 003 02 05	TRB
---	--	--	--	----------------	---------------	-----

O 370 U

Eixo Traseiro / Eje Trasero / Rear Axle

Diferencial - eixo (traseiro) / Diferencial - eje (trasero) / Differential - shaft (rear)				32018 XF	004 981 43 05	TRB
				F 15159	006 981 35 05	TRBS

Eixo Dianteiro / Eje Delantero / Front Axle

Roda / Rueda / Wheel				F 15051 C	005 981 30 05	TRBS
----------------------	--	--	--	------------------	---------------	------

O 371 U * O 371 UL * O 371 UP

Caixa de Mudanças / Caja de Cambios / Gearbox

				F 19011	3459818101	CRBS
Eixo secundário / Eje secundario / Secondary shaft				F 19044	3449817001	CRBS

Eixo Traseiro / Eje Trasero / Rear Axle

Diferencial / Diferencial / Differential				32314 BF	003 981 31 05	TRB
Diferencial - eixo (traseiro) / Diferencial - eje (trasero) / Differential - shaft (rear)				32018 XF	004 981 43 05	TRB
				F 15159	006 981 35 05	TRBS
Diferencial - eixo (traseiro, pinhão de apoio) / Diferencial - (eje trasero, piñón de apoyo) / Differential - rear shaft support pinion			HO4 / 23	F 19043	3459817301	CRBS

Eixo Traseiro / Eje Trasero / Rear Axle

Roda / Rueda / Wheel	•			33117 F	001 980 67 02	TRB
		•		33019 F	000 980 96 02	TRB
				33215 F	002 981 86 05	TRB

Eixo Dianteiro / Eje Delantero / Front Axle

Roda / Rueda / Wheel				F 15051 C	005 981 30 05	TRBS
----------------------	--	--	--	------------------	---------------	------

Motor / Motor / Engine

Bomba injetora y ventilador / Bomba de inyección y ventilador / Injection pump & fan				30204 F	072 003 02 04	TRB
--	--	--	--	----------------	---------------	-----



O 817

Caixa de Mudanças / Caja de Cambios / Gearbox

				30306 F	001 981 57 05	TRB
				32208 F	LA5113	TRB
				32210 F	LA5115	TRB

Eixo Dianteiro y Traseiro / Eje Delantero y Trasero / Front and Rear Axle

				33111 F	000 980 75 02	TRB
--	--	--	--	----------------	---------------	-----

	OUT	IN		Fersa [®]	Nº OEM	
---	-----	----	---	---------------------------	--------	---

MERCEDES BENZ (CA)

O 817

Eixo Dianteiro / Eje Delantero / Front Axle

Roda / Rueda / Wheel				33109 F	003 981 16 05	TRB
				33205 F	006 981 58 05	TRB
				32306 F	3129810205	TRB

OH 1113

Eixo Traseiro / Eje Trasero / Rear Axle

Diferencial / Diferencial / Differential				F 15083	003 981 19 05	TRBS
Diferencial - eixo (traseiro) / Diferencial - eje (trasero) / Differential - shaft (rear)				32018 XF	004 981 43 05	TRB
				32020 XF	001 981 64 05	TRB
				F 15082	001 981 99 05	TRBS
				F 15159	006 981 35 05	TRBS
Diferencial - pinhão (eixo dianteiro / traseiro) / Diferencial - piñón - eje (delantero / trasero) / Differential - pinion (front / rear)				F 15158	012 981 85 05	TRBS

Eixo Dianteiro / Eje Delantero / Front Axle

Roda / Rueda / Wheel				497 / 492 A	000 981 61 05	TRB
				33214 F	003 981 52 05	TRB

OH 1419 * OH 1420 * OH 1421

Caixa de Mudanças / Caja de Cambios / Gearbox

				32208 F	LA5113	TRB
				2789 / 2720	501398228	TRB
				3382 / 3320	050 139 82 17	TRB

Eixo Traseiro / Eje Trasero / Rear Axle

Diferencial / Diferencial / Differential				F 15083	003 981 19 05	TRBS
Diferencial - eixo (traseiro) / Diferencial - eje (trasero) / Differential - shaft (rear)				32017 XF	184623	TRB
				32018 XF	004 981 43 05	TRB
				32020 XF	001 981 64 05	TRB
				F 15082	001 981 99 05	TRBS

Eixo Dianteiro / Eje Delantero / Front Axle

Roda / Rueda / Wheel				559 / 552 A	3449817005	TRB
----------------------	--	--	--	--------------------	------------	-----

OH 1517 * OH 1518 * OH 1519 * OH 1520 * OH 1521

Eixo Traseiro / Eje Trasero / Rear Axle

Diferencial / Diferencial / Differential				F 15083	003 981 19 05	TRBS
Diferencial - eixo (traseiro) / Diferencial - eje (trasero) / Differential - shaft (rear)				32017 XF	184623	TRB
				32018 XF	004 981 43 05	TRB
				32020 XF	001 981 64 05	TRB
				F 15082	001 981 99 05	TRBS
				F 15159	006 981 35 05	TRBS
				H 715345 / H 715311	181342	TRB
Roda / Rueda / Wheel	•			32307 F	003 981 64 05	TRB
		•		32218 F	072 003 22 18	TRB

OH 1524 * OH 1525

Eixo Traseiro / Eje Trasero / Rear Axle

Diferencial - eixo (traseiro) / Diferencial - eje (trasero) / Differential - shaft (rear)				F 15159	006 981 35 05	TRBS
				H 715345 / H 715311	181342	TRB
Roda / Rueda / Wheel		•		32218 F	072 003 22 18	TRB

	OUT	IN		Fersa [®]	Nº OEM	
---	-----	----	---	---------------------------	--------	---

MOTOR COACH

F11 * F11A

Eixo Dianteiro / Eje Delantero / Front Axle

Roda / Rueda / Wheel	•		HM 212049 / HM 212011		TRB
	•		3782 / 3720	807949	TRB

Eixo Traseiro / Eje Trasero / Rear Axle

Roda / Rueda / Wheel	•		580 / 572	39811405	TRB
		•	594 A / 592 A	183704	TRB

F12

Eixo Traseiro / Eje Trasero / Rear Axle

Diferencial - (dir. / esq.) / Diferencial - (der. / izq.) / Differential (right / left)			Rockwell RC-23-160: 1511 / 1560 / 1658 / 1660	32021 XF	TRB
			Rockwell RC-23-160: 1706 / 1708 / 1712 / 1823 / 1825 / 1892 / 1897 / 1928 / 1929	594 A / 592 A	183704
Diferencial - pinhão cabeça / Diferencial - piñón cabeza / Differential - pinion head			Rockwell RC-23-160: 1511 / 1560 / 1658 / 1660 / 1706 / 1708 / 1712 / 1823 / 1825 / 1892 / 1897 / 1928 / 1929	9278 / 9220	TRB
			Rockwell RC-23-160: 1511 / 1560 / 1658 / 1 660 / 1706 / 1708 / 1712 / 1823 / 1825 / 1892 / 1897 / 1928 / 1929	HM 813843 / HM 813810	TRB
			Rockwell RC-23-160: 1511 / 1560 / 1658 / 1660 / 1706 / 1708 / 1712 / 1823 / 1825 / 1892 / 1897 / 1928 / 1929	F 19033	CRBS

Eixo Dianteiro / Eje Delantero / Front Axle

Roda / Rueda / Wheel	•		3782 / 3720	807949	TRB
		•	HM 212049 / HM 212011		TRB

Eixo Traseiro / Eje Trasero / Rear Axle

Roda / Rueda / Wheel	•		580 / 572	39811405	TRB
		•	594 A / 592 A	183704	TRB

F14

Eixo Dianteiro / Eje Delantero / Front Axle

Roda / Rueda / Wheel	•		3782 / 3720	807949	TRB
		•	HM 212049 / HM 212011		TRB

Eixo Traseiro / Eje Trasero / Rear Axle

Roda / Rueda / Wheel	•		580 / 572	39811405	TRB
		•	594 A / 592 A	183704	TRB

P11 * P12

Eixo Dianteiro / Eje Delantero / Front Axle

Roda / Rueda / Wheel	•		3782 / 3720	807949	TRB
		•	HM 212049 / HM 212011		TRB

Eixo Traseiro / Eje Trasero / Rear Axle

Roda / Rueda / Wheel	•		580 / 572	39811405	TRB
		•	594 A / 592 A	183704	TRB



	OUT	IN		Fersa [®]	Nº OEM	
---	-----	----	---	---------------------------	--------	---

SCANIA (NA & CA)

K 113 IB (4X2) Busscar

Eixo Traseiro / Eje Trasero / Rear Axle

Diferencial - eixo (traseiro) / Diferencial - eje (trasero) / Differential - shaft (rear)				31312 F	7181609	TRB
				32020 XF	720032020	TRB

K 114 IB (4X2) Busscar

Eixo Traseiro / Eje Trasero / Rear Axle

Diferencial - (dir. / esq.) / Diferencial - (der. / izq.) / Differential (right / left)				33017 F		TRB
				JM 720249 / JM 720210		TRB
Diferencial - flecha intermediária (dir.) / Diferencial - flecha intermedia (der.) / Differential - intermediate shaft (right)				30312 F	1523056	TRB
Diferencial - flecha primaria e secundária (dir.) / Diferencial - flecha primaria y secundaria (der.) / Differential - primary / secondary shaft (right)				30314 F		TRB
Diferencial - pinhão cola / Diferencial - piñón cola / Differential - rear pinion				30312 F	1523056	TRB
				31312 F	7181609	TRB

K 114 IB (4X2) LB 340 Irizar

Eixo Traseiro / Eje Trasero / Rear Axle

Diferencial - (dir. / esq.) / Diferencial - (der. / izq.) / Differential (right / left)				33017 F		TRB
				JM 720249 / JM 720210		TRB
Diferencial - flecha intermediária (dir.) / Diferencial - flecha intermedia (der.) / Differential - intermediate shaft (right)				30312 F	1523056	TRB
Diferencial - flecha primaria e secundária (dir.) / Diferencial - flecha primaria y secundaria (der.) / Differential - primary / secondary shaft (right)				30314 F		TRB
Diferencial - pinhão cola / Diferencial - piñón cola / Differential - rear pinion				31312 F	7181609	TRB
				30312 F	1523056	TRB

K 114 IB (4X2) NB 340 K

Eixo Traseiro / Eje Trasero / Rear Axle

Diferencial (esq.) / Diferencial (izq.) / Differential (left)				33017 F		TRB
Diferencial - flecha intermediária (dir.) / Diferencial - flecha intermedia (der.) / Differential - intermediate shaft (right)				30312 F	1523056	TRB
Diferencial - pinhão cola / Diferencial - piñón cola / Differential - rear pinion				31312 F	7181609	TRB
Diferencial (dir.) / Diferencial (der.) / Differential (right)				JM 720249 / JM 720210		TRB
Diferencial / Diferencial / Differential				30314 F		TRB

K 124 CA (4x2) NB 340K

Eixo Dianteiro / Eje Delantero / Front Axle

Roda / Rueda / Wheel	•			32308 F		TRB
----------------------	---	--	--	----------------	--	-----

Eixo Traseiro / Eje Trasero / Rear Axle

Diferencial - eixo (traseiro) / Diferencial - eje (trasero) / Differential - shaft (rear)				33018 F		TRB
				31312 F	7181609	TRB
Roda / Rueda / Wheel	•			HM 218248 / HM 218210	291060	TRB
		•		HM 218248 / HM 218210	291060	TRB

	OUT	IN		Fersa [®]	N° OEM	
---	-----	----	---	---------------------------	--------	---

SCANIA (NA & CA)

K 124 IB (4x2) Vissta Bus

Eixo Traseiro / Eje Trasero / Rear Axle

Diferencial - pinhão cabeça / Diferencial - piñón cabeza / Differential - pinion head				JM 720249 / JM 720210		TRB
Diferencial - pinhão cola / Diferencial - piñón cola / Differential - rear pinion				33017 F		TRB

L 114 IB (4x2) LB 340 Urbanuss

Eixo Traseiro / Eje Trasero / Rear Axle

Diferencial (esq.) / Diferencial (izq.) / Differential (left)				33017 F		TRB
Diferencial - pinhão cabeça / Diferencial - piñón cabeza / Differential - pinion head				31312 F	7181609	TRB
Diferencial (dir.) / Diferencial (der.) / Differential (right)				JM 720249 / JM 720210		TRB

L 94 VB (4x2) 220HP Urbanuss

Eixo Traseiro / Eje Trasero / Rear Axle

Diferencial (esq.) / Diferencial (izq.) / Differential (left)				33017 F		TRB
Diferencial - pinhão cola / Diferencial - piñón cola / Differential - rear pinion				31312 F	7181609	TRB
Diferencial (dir.) / Diferencial (der.) / Differential (right)				JM 720249 / JM 720210		TRB

T 113 H (4x2) Paradiso



Eixo Dianteiro / Eje Delantero / Front Axle

Roda / Rueda / Wheel	●		95...00	32308 F		TRB
----------------------	---	--	---------	----------------	--	-----

Eixo Traseiro / Eje Trasero / Rear Axle

Diferencial - eixo (traseiro) / Diferencial - eje (trasero) / Differential - shaft (rear)				31312 F	7181609	TRB
				32020 XF	720032020	TRB
Diferencial - pinhão eixo (traseiro) / Diferencial - piñón eje (trasero) / Differential - shaft pinion (rear)				F 15046		TRBS
Diferencial (dir.) / Diferencial (der.) / Differential (right)				30207 F	6600169	TRB
Roda / Rueda / Wheel	●		95...00	HM 218248 / HM 218210	291060	TRB
		●	95...00	HM 218248 / HM 218210	291060	TRB
		●	ASA 604-95	32309 F		TRB
		●	ASA 604-95	32312 F		TRB



	OUT	IN		Fersa®	Nº OEM	
---	-----	----	---	---------------	--------	---

SCANIA (SA)

101 (L*LS) * 111 (B) * 111 Articulado (B)

Caixa de Mudanças / Caja de Cambios / Gearbox

Eixo de ré (dianteiro / traseiro) / Eje inverso (delantero / trasero) / Reverse shaft (front / rear)				6007 C3	174668	BB
Eixo intermediário (traseiro) / Eje intermedio (trasero) / Intermediate shaft (rear)				6309 ZNR / C3	14096	BB
Eixo primário (traseiro) / Eje primario (trasero) / Primary shaft (rear)				6413 NR / C3		BB
Eixo secundário (traseiro) / Eje secundario (trasero) / Secondary shaft (rear)				6411 NR / C3		BB

Cardan / Cardan / Cardan

Suporte / Soporte / Support				6211	14093	BB
-----------------------------	--	--	--	-------------	-------	----

Eixo Dianteiro / Eje Delantero / Front Axle

Roda / Rueda / Wheel				31308 F	14613	TRB
				31309 F	14834	TRB
	•			32308 F	14698	TRB
		•		32311 F	179427	TRB

Eixo Traseiro / Eje Trasero / Rear Axle

Diferencial - coroa lateral (dir. / esq.) / Diferencial - corona lateral (der. / izq.) / Differential - crown gear (right / left)			101 L / LS R 653 * 111 B * artic.R 651	30217 F	174631	TRB
Diferencial - pinhão (dianteiro) / Diferencial - piñón (delantero) / Differential - pinion (front)				31312 F	174716	TRB
Diferencial - pinhão (traseiro) / Diferencial - piñón (trasero) / Differential - pinion (rear)				32315 BF	194137	TRB
			101 L / LS R 653 * 111 B * artic.R 651	F 15046		TRBS
				F 15046	194050	TRBS
Roda / Rueda / Wheel				32218 F	14835	TRB

Embreagem / Embrague / Clutch

Alavanca de acionamento / Palanca de accionamiento / Drive lever				6201 ZZ		BB
Apoio / Apoyo / Support				6305 2RS	168248	BB

Motor / Motor / Engine

Alternador (dianteiro) / Alternador (delantero) / Alternator (front)				6202 Z / C3		BB
Alternador (traseiro) / Alternador (trasero) / Alternator (rear)				6201 Z / C3		BB
Bomba d'água (dianteiro) / Bomba de agua (delantero) / Water pump (front)				6305 2RS	2288365	BB
Bomba d'água (traseiro) / Bomba de agua (trasero) / Water pump (rear)				6205 2RS / C3	14090	BB
Bomba de óleo / Bomba de aceite / Oil pump				6304	152897	BB
				6304 C4		BB
Bomba injetora (dianteiro) / Bomba inyectora (delantero) / Injection pump (front)				6207 C3	14091	BB
Bomba injetora (traseiro) / Bomba inyectora (trasero) / Injection pump (rear)				6007	140180	BB
Compressor (dianteiro) / Compresor (delantero) / Compressor (front)				6207 C3		BB
Compressor (traseiro) / Compresor (trasero) / Compressor (rear)				6011 / C3		BB
Compressor de ar (dianteiro) / Compresor de aire (delantero) / Air compressor (front)				6207 C3	14091	BB
Compressor de ar (traseiro) / Compresor de aire (trasero) / Air compressor (rear)				6011 / C3	141930	BB
Polia tensora / Polea tensora / Tensioner pulley				6205 2RS	139246	BB

	OUT	IN		Fersa [®]	Nº OEM	
---	-----	----	---	---------------------------	--------	---

SCANIA (SA)

101 (L*LS) * 111 (B) * 111 Articulado (B)

Tomada de Força / Toma de Fuerza / Power Take-off

Eixo de saída (dianteiro) / Eje de salida (delantero) / Output shaft (front)				32306 F	14614	TRB
Eixo de saída (traseiro) / Eje de salida (traseiro) / Output shaft (rear)				32208 F	214104	TRB

110 (B)

Caixa de Mudanças / Caja de Cambios / Gearbox

Eixo de ré (dianteiro / traseiro) / Eje inverso (delantero / traseiro) / Reverse shaft (front / rear)				6007 C3	174668	BB
Eixo intermediário (dianteiro) / Eje intermedio (delantero) / Intermediate shaft (front)				6312 NR / C3		BB
				6407 C3		BB
				6408 NR / C3		BB
Eixo intermediário (traseiro) / Eje intermedio (traseiro) / Intermediate shaft (rear)				6309 NR / C3		BB
				6309 ZNR / C3	14096	BB
Eixo primário (traseiro) / Eje primario (traseiro) / Primary shaft (rear)				6311 NR / C3		BB
				6413 NR / C3		BB
Eixo primário / Eje primario / Primary shaft				6413 NR / C3		BB
Eixo secundário (traseiro) / Eje secundario (traseiro) / Secondary shaft (rear)				6311 NR / C3		BB
				6314 NR / C3		BB
				6411 NR / C3		BB
Planetário - eixo secundário (traseiro) / Planetario - eje secundario (traseiro) / Planetary - secondary shaft (rear)				6215 NR / C3		BB

Cardan / Cardan / Cardan

Suporte / Soporte / Support			EGR 86	6211	14093	BB
-----------------------------	--	--	--------	-------------	-------	----

Eixo Dianteiro / Eje Delantero / Front Axle

Roda / Rueda / Wheel				31308 F	14613	TRB
				31309 F	14834	TRB
	•			32308 F	14698	TRB
		•		32311 F	179427	TRB

Eixo Traseiro / Eje Trasero / Rear Axle



Diferencial - coroa lateral (dir. / esq.) / Diferencial - corona lateral (der. / izq.) / Differential - crown gear (right / left)			R 651	30217 F	174631	TRB
Diferencial - coroa lateral (dir.) / Diferencial - corona lateral (der.) / Differential - crown gear (right)			R 751	497 / 493		TRB
Diferencial - pinhão (dianteiro) / Diferencial - piñón (delantero) / Differential - pinion (front)			R 651	31312 F	174716	TRB
Diferencial - pinhão (traseiro) / Diferencial - piñón (traseiro) / Differential - pinion (rear)			R 751	32315 BF		TRB
				32315 BF	194137	TRB
			R 651	F 15046		TRBS
				F 15046	194050	TRBS
Roda / Rueda / Wheel				32218 F	14835	TRB

Embreagem / Embrague / Clutch

Apoio / Apoyo / Support				6305 2RS	168248	BB
-------------------------	--	--	--	-----------------	--------	----

Motor / Motor / Engine

Alternador (dianteiro) / Alternador (delantero) / Alternator (front)				6202 Z / C3		BB
--	--	--	--	--------------------	--	----

	OUT	IN		Fersa®	Nº OEM	
---	-----	----	---	---------------	--------	---

SCANIA (SA)

110 (B)

Alternador (traseiro) / Alternador (trasero) / Alternator (rear)				6201 Z / C3		BB
Bomba d'água (dianteiro) / Bomba de agua (delantero) / Water pump (front)				6305 2RS	2288365	BB
Bomba d'água (traseiro) / Bomba de agua (trasero) / Water pump (rear)				6205 2RS / C3	14090	BB
Bomba de óleo / Bomba de aceite / Oil pump				6304	152897	BB
Bomba injetora (dianteiro) / Bomba inyectora (delantero) / Injection pump (front)				6207 C3	14091	BB
Bomba injetora (traseiro) / Bomba inyectora (trasero) / Injection pump (rear)				6007	140180	BB
Compressor de ar (dianteiro) / Compresor de aire (delantero) / Air compressor (front)				6207 C3	14091	BB
Compressor de ar (traseiro) / Compresor de aire (trasero) / Air compressor (rear)				6011 / C3	141930	BB
Polia tensora / Polea tensora / Tensioner pulley				6205 2RS	139246	BB

Tomada de Força / Toma de Fuerza / Power Take-off

Eixo de saída (dianteiro) / Eje de salida (delantero) / Output shaft (front)			EGR 86	32306 F	14614	TRB
Eixo de saída (traseiro) / Eje de salida (trasero) / Output shaft (rear)			EGR 86	32208 F	214104	TRB

110 (L*LS)

Caixa de Mudanças / Caja de Cambios / Gearbox

Eixo de ré (dianteiro / traseiro) / Eje inverso (delantero / trasero) / Reverse shaft (front / rear)				6007 C3	174668	BB
Eixo intermediário (dianteiro) / Eje intermedio (delantero) / Intermediate shaft (front)				6312 NR / C3		BB
Eixo intermediário (traseiro) / Eje intermedio (trasero) / Intermediate shaft (rear)				6309 ZNR / C3	14096	BB
Eixo primário / Eje primario / Primary shaft				6413 NR / C3		BB
Eixo secundário (traseiro) / Eje secundario (trasero) / Secondary shaft (rear)				6314 NR / C3		BB
Planetário - eixo secundário (traseiro) / Planetario - eje secundario (trasero) / Planetary - secondary shaft (rear)				6215 NR / C3		BB

Cardan / Cardan / Cardan

Suporte / Soporte / Support			EGR 86	6211	14093	BB
-----------------------------	--	--	--------	-------------	-------	----

Eixo Dianteiro / Eje Delantero / Front Axle

Roda / Rueda / Wheel				31308 F	14613	TRB
				31309 F	14834	TRB
	•			32308 F	14698	TRB
		•		32311 F	179427	TRB

Eixo Traseiro / Eje Trasero / Rear Axle

Diferencial - coroa lateral (dir. / esq.) / Diferencial - corona lateral (der. / izq.) / Differential - crown gear (right / left)				30217 F	174631	TRB
Diferencial - coroa lateral (dir.) / Diferencial - corona lateral (der.) / Differential - crown gear (right)			R 751	497 / 493		TRB
Diferencial - pinhão (dianteiro) / Diferencial - piñón (delantero) / Differential - pinion (front)				31312 F	174716	TRB
Diferencial - pinhão (traseiro) / Diferencial - piñón (trasero) / Differential - pinion (rear)			R 751	32315 BF	194137	TRB
				F 15046	194050	TRBS
Roda / Rueda / Wheel				32218 F	14835	TRB
Terceiro eixo - balanc. (externo) / Tercer eje - balanc. (externo) / Third axle (outer)				32316 F		TRB

	OUT	IN		Fersa [®]	Nº OEM	
---	-----	----	---	---------------------------	--------	---

SCANIA (SA)

110 (L*LS)

Terceiro eixo - balanc. (interno) / Tercer eje - balanc. (interno) / Third axle (inner)				32220 F		TRB
Terceiro eixo - jumelo (dir. / esq.) / Tercer eje - jumel (der. / izq.) / Third axle jumel (right / left)				32207 F		TRB

Embreagem / Embrague / Clutch

Alavanca de acionamento / Palanca de accionamiento / Drive lever				6201 ZZ		BB
Apoio / Apoyo / Support				6305 2RS	168248	BB

Motor / Motor / Engine

Alternador (dianteiro) / Alternador (delantero) / Alternator (front)				6202 Z / C3		BB
Alternador (traseiro) / Alternador (trasero) / Alternator (rear)				6201 Z / C3		BB
Bomba d'água (dianteiro) / Bomba de agua (delantero) / Water pump (front)				6305 2RS	2288365	BB
Bomba d'água (traseiro) / Bomba de agua (trasero) / Water pump (rear)				6205 2RS / C3	14090	BB
Bomba de óleo / Bomba de aceite / Oil pump				6304	152897	BB
Bomba injetora (dianteiro) / Bomba inyectora (delantero) / Injection pump (front)				6207 C3	14091	BB
Bomba injetora (traseiro) / Bomba inyectora (trasero) / Injection pump (rear)				6007	140180	BB
Compressor de ar (dianteiro) / Compresor de aire (delantero) / Air compressor (front)				6207 C3	14091	BB
Compressor de ar (traseiro) / Compresor de aire (trasero) / Air compressor (rear)				6011 / C3	141930	BB
Polia tensora / Polea tensora / Tensioner pulley				6205 2RS	139246	BB

Tomada de Força / Toma de Fuerza / Power Take-off

Eixo de saída (dianteiro) / Eje de salida (delantero) / Output shaft (front)				32306 F	14614	TRB
			EGR 86	32306 F		TRB
Eixo de saída (traseiro) / Eje de salida (trasero) / Output shaft (rear)				32208 F	214104	TRB
			EGR 86	32208 F		TRB

111 (L*LS*LT)

Caixa de Mudanças / Caja de Cambios / Gearbox

Eixo secundário (traseiro) / Eje secundario (trasero) / Secondary shaft (rear)			GR 860	6314 NR / C3		BB
Planetário - eixo secundário (traseiro) / Planetario - eje secundario (trasero) / Planetary - secondary shaft (rear)			GR 860	6215 NR / C3		BB

Cardan / Cardan / Cardan

Suporte / Soporte / Support				6211		BB
-----------------------------	--	--	--	-------------	--	----

Eixo Traseiro / Eje Trasero / Rear Axle

Diferencial - coroa lateral (dir. / esq.) / Diferencial - corona lateral (der. / izq.) / Differential - crown gear (right / left)			RB 651 * RB 652 * R 651	30217 F		TRB
Diferencial - coroa lateral (dir.) / Diferencial - corona lateral (der.) / Differential - crown gear (right)			R 752	33017 F		TRB
			RP 750	497 / 493		TRB
Diferencial - coroa lateral (esq.) / Diferencial - coroa lateral (izq.) / Differential - crown gear (left)			R 752	32022 XF		TRB
			RP 750	56425 / 56650		TRB
Diferencial - divisor de torque (dianteiro) / Diferencial - divisor de par (delantero) / Differential - torque divisor (front)			RB 652	JLM 508748 / JLM 508710		TRB

	OUT	IN		Fersa®	N° OEM	
---	-----	----	---	---------------	--------	---

SCANIA (SA)

111 (L*LS*LT)

Diferencial - pinhão (dianteiro) / Diferencial - piñón (delantero) / Differential - pinion (front)				31312 F		TRB
			R 752	F 15046		TRBS
Diferencial - pinhão (traseiro) / Diferencial - piñón (trasero) / Differential - pinion (rear)			RB 652	31313 F		TRB
			R 751	32315 BF		TRB
			RB 651	F 15046		TRBS
Terceiro eixo - balanc. (externo) / Tercer eje - balanc. (externo) / Third axle (outer)			111 LS * LT	32316 F		TRB
Terceiro eixo - balanc. (interno) / Tercer eje - balanc. (interno) / Third axle (inner)			111 LS * LT	32220 F		TRB
Terceiro eixo - jumelo (dir. / esq.) / Tercer eje - jumel (der. / izq.) / Third axle jumel (right / left)			111 LS * LT	32207 F		TRB

Motor / Motor / Engine

Alternador (dianteiro) / Alternador (delantero) / Alternator (front)				6202 2RS / C3		BB
Alternador (traseiro) / Alternador (trasero) / Alternator (rear)				6201 2RS / C3		BB
Bomba d'água (dianteiro) / Bomba de agua (delantero) / Water pump (front)				6205 2RS		BB
Bomba d'água (traseiro) / Bomba de agua (trasero) / Water pump (rear)				6305 2RS / C3		BB
Bomba de óleo / Bomba de aceite / Oil pump				6304 C3		BB
Bomba injetora (dianteiro) / Bomba inyectora (delantero) / Injection pump (front)				6207 C3		BB
Bomba injetora (traseiro) / Bomba inyectora (trasero) / Injection pump (rear)				6007		BB
Compressor (dianteiro) / Compresor (delantero) / Compressor (front)				6207 C3		BB
Compressor (traseiro) / Compresor (trasero) / Compressor (rear)				6011 C3		BB

Tomada de Força / Toma de Fuerza / Power Take-off

Eixo de saída (dianteiro) / Eje de salida (delantero) / Output shaft (front)			EGR 860	32306 F		TRB
Eixo de saída (traseiro) / Eje de salida (trasero) / Output shaft (rear)			EGR 860	32208 F		TRB

115 * 116 BR

Caixa de Mudanças / Caja de Cambios / Gearbox



Eixo de ré (dianteiro / traseiro) / Eje inverso (delantero / trasero) / Reverse shaft (front / rear)				6007 C3	174668	BB
Eixo intermediário (dianteiro) / Eje intermedio (delantero) / Intermediate shaft (front)			G 760 / G 764	6408 NR / C3		BB
Eixo intermediário (traseiro) / Eje intermedio (trasero) / Intermediate shaft (rear)				6309 ZNR / C3	14096	BB
Eixo primário / Eje primario / Primary shaft			G 760 / G 764	6413 NR / C3		BB
Eixo secundário (dianteiro) / Eje secundario (delantero) / Secondary shaft (front)			G 774	33208 F		TRB
Eixo secundário (traseiro) / Eje secundario (trasero) / Secondary shaft (rear)			G 760 / G 764	6411 NR / C3		BB

Cardan / Cardan / Cardan

Suporte / Soporte / Support				6211	14093	BB
-----------------------------	--	--	--	-------------	-------	----

Eixo Dianteiro / Eje Delantero / Front Axle

Roda / Rueda / Wheel				31308 F	14613	TRB
				31309 F	14834	TRB
•				32308 F	14698	TRB
	•			32311 F	179427	TRB

	OUT	IN		Fersa [®]	Nº OEM	
---	-----	----	---	---------------------------	--------	---

SCANIA (SA)

115 * 116 BR

Eixo Traseiro / Eje Trasero / Rear Axle

Diferencial - coroa lateral (dir. / esq.) / Diferencial - coroa lateral (der. / izq.) / Differential - crown gear (right / left)				30217 F	174631	TRB
Diferencial - pinhão (dianteiro) / Diferencial - piñón (delantero) / Differential - pinion (front)			R 651 / R 653	31312 F	174716	TRB
Diferencial - pinhão (traseiro) / Diferencial - piñón (trasero) / Differential - pinion (rear)				32315 BF	194137	TRB
			R 651 / R 653	F 15046		TRBS
				F 15046	194050	TRBS
Roda / Rueda / Wheel				32218 F	14835	TRB

Embreagem / Embrague / Clutch

Apoio / Apoyo / Support				6305 2RS	168248	BB
-------------------------	--	--	--	-----------------	--------	----

Motor / Motor / Engine

Alternador (dianteiro) / Alternador (delantero) / Alternator (front)				6202 Z / C3		BB
Alternador (traseiro) / Alternador (trasero) / Alternator (rear)				6201 Z / C3		BB
Bomba d'água - rodam. / Bomba de agua - rodam. / Water pump - bearing			BR 115	6305		BB
Bomba d'água (dianteiro) / Bomba de agua (delantero) / Water pump (front)			BR 116	6205 2RS		BB
				6305 2RS	2288365	BB
Bomba d'água (traseiro) / Bomba de agua (trasero) / Water pump (rear)				6205 2RS / C3	14090	BB
			BR 116	6305 2RS / C3		BB
Bomba de óleo / Bomba de aceite / Oil pump				6304	152897	BB
Bomba injetora (dianteiro) / Bomba inyectora (delantero) / Injection pump (front)				6207 C3	14091	BB
Bomba injetora (traseiro) / Bomba inyectora (trasero) / Injection pump (rear)				6007	140180	BB
Compressor de ar (dianteiro) / Compressor de aire (delantero) / Air compressor (front)				6207 C3	14091	BB
Compressor de ar (traseiro) / Compressor de aire (trasero) / Air compressor (rear)				6011 / C3	141930	BB
Polia tensora - rodam. / Polea tensora - rodam. / Tensioner pulley - bearing			BR 116	6205 2RS		BB
			BR 115	6205 RS		BB
Polia tensora / Polea tensora / Tensioner pulley				6205 2RS	139246	BB
Ventilador - polia / Ventilador polea / Fan pulley				6305		BB

Tomada de Força / Toma de Fuerza / Power Take-off

Eixo de saída (dianteiro) / Eje de salida (delantero) / Output shaft (front)				32306 F	14614	TRB
Eixo de saída (traseiro) / Eje de salida (trasero) / Output shaft (rear)				32208 F	214104	TRB



140 (LK*LKS)

Caixa de Mudanças / Caja de Cambios / Gearbox

Eixo de saída (traseiro) / Eje de salida (trasero) / Output shaft (rear)			GR 860	6314 NR / C3		BB
Eixo secundário (dianteiro) / Eje secundario (delantero) / Secondary shaft (front)				33208 F	284843	TRB
Planetário - eixo de saída (traseiro) / Planetario - eje de salida (trasero) / Planetary - output shaft (rear)			GR 860	6215 NR / C3		BB

Cardan / Cardan / Cardan

Suporte / Soporte / Support				6211		BB
				6212	14381	BB

	OUT	IN		Fersa [®]	Nº OEM	
---	-----	----	---	---------------------------	--------	---

SCANIA (SA)

140 (LK*LKS)

Direção / Dirección / Steering

Direção hidráulica - pinhão / Dirección hidráulica - piñón / Hydraulic direction - pinion				6007 C3		BB
---	--	--	--	----------------	--	----

Eixo Dianteiro / Eje Delantero / Front Axle

Roda / Rueda / Wheel	•			32308 F	14698	TRB
	•			32309 F	14623	TRB
		•		32311 F	179427	TRB
		•		32312 F	14836	TRB

Eixo Traseiro / Eje Trasero / Rear Axle

Diferencial - coroa lateral (dir. / esq.) / Diferencial - corona lateral (der. / izq.) / Differential - crown gear (right / left)				30217 F	174717	TRB
Diferencial - coroa lateral (dir.) / Diferencial - corona lateral (der.) / Differential - crown gear (right)			RP 750	497 / 493		TRB
Diferencial - coroa lateral (esq.) / Diferencial - coroa lateral (izq.) / Differential - crown gear (left)			RP 750	56425 / 56650		TRB
Diferencial - pinhão (dianteiro) / Diferencial - piñón (delantero) / Differential - pinion (front)				31312 F	174716	TRB
				32315 BF	194137	TRB
			RP 750	F 15046		TRBS
				F 15046	194050	TRBS
Diferencial - pinhão (traseiro) / Diferencial - piñón (trasero) / Differential - pinion (rear)			R 751	32315 BF		TRB
Roda / Rueda / Wheel				32020 XF	274114	TRB
				32218 F	14835	TRB
				32219 F	33948	TRB
Terceiro eixo - balanc. (externo) / Tercer eje - balanc. (externo) / Third axle (outer)			LKS	32316 F		TRB
Terceiro eixo - balanc. (interno) / Tercer eje - balanc. (interno) / Third axle (inner)			LKS	32220 F		TRB
Terceiro eixo - jumelo (dir. / esq.) / Tercer eje - jumel (der. / izq.) / Third axle jumel (right / left)			LKS	32207 F		TRB

Embreagem / Embrague / Clutch

Apoyo / Apoyo / Support				6305 2RS		BB
				6305 2RS	168248	BB
Desengate / Desembrague / Clutch				6212	14831	BB

Motor / Motor / Engine

Alternador (dianteiro) / Alternador (delantero) / Alternator (front)				6202 Z / C3		BB
				6303 2RS / C3	220137	BB
Alternador (traseiro) / Alternador (trasero) / Alternator (rear)				6201 Z / C3		BB
Bomba d'água - rodam / Bomba de agua - rodam. / Water pump - bearing				6205		BB
Bomba d'água / Bomba de agua / Water pump				6205 2RS / C3	14090	BB
Bomba injetora (traseiro) / Bomba inyectora (trasero) / Injection pump (rear)				6205 C3	170727	BB
				6305 C3	170793	BB
Compressor de ar (dianteiro) / Compresor de aire (delantero) / Air compressor (front)				6207 C3	14091	BB
Compressor de ar (traseiro) / Compresor de aire (trasero) / Air compressor (rear)				6011 C3	141930	BB
Direção - pinhão / Dirección - piñón / Direction - pinion				6007 C3	174668	BB
Direção / Dirección / Direction				6304	14125	BB

	OUT	IN		Fersa®	Nº OEM	
---	-----	----	---	---------------	--------	---

SCANIA (SA)

140 (LK*LKS)

Ventilador (dianteiro) / Ventilador (delantero) / Fan (front)				6207 C3	14091	BB
Ventilador (traseiro) / Ventilador (trasero) / Fan (rear)				6307	14610	BB

Tomada de Força / Toma de Fuerza / Power Take-off

Eixo de saída (dianteiro) / Eje de salida (delantero) / Output shaft (front)			EGR 860	32306 F	14614	TRB
Eixo de saída (traseiro) / Eje de salida (trasero) / Output shaft (rear)			EGR 860	32208 F	214104	TRB

K 113

Caixa de Mudanças / Caja de Cambios / Gearbox

Eixo intermediário (dir.) / Eje intermedio (der.) / Intermediate shaft (right)				30312 F		TRB
Eixo primário / Eje primario / Primary shaft				30314 F		TRB
Eixo secundário (dianteiro) / Eje secundario (delantero) / Secondary shaft (front)			G 777	33208 F		TRB
Eixo secundário (dir.) / Eje secundario (der.) / Secondary shaft (right)				30314 F		TRB
			330 / 360 / 420 * GRS 900 / GRS 900 R T 114 LA (6X2) 420	30314 F		TRB

Eixo Traseiro / Eje Trasero / Rear Axle

Diferencial - coroa lateral (dir.) / Diferencial - corona lateral (der.) / Differential - crown gear (right)			RP 831	30217 F		TRB
Diferencial - pinhão (traseiro) / Diferencial - piñón (trasero) / Differential - pinion (rear)			R 653	F 15046		TRBS
Eixo de apoio - roda (externo) / Rueda - eje de apoyo (ext.) / Support shaft - wheel (outer)			ASA 60	32309 F		TRB
Eixo de apoio - roda (interno) / Rueda - eje de apoyo (int.) / Support shaft - wheel (inner)			ASA 60	32312 F		TRB

Embreagem / Embrague / Clutch

Desengate / Desembrague / Clutch				6014 2RS		BB
----------------------------------	--	--	--	-----------------	--	----

Motor / Motor / Engine

Bomba d'água (dianteiro) / Bomba de agua (delantero) / Water pump (front)				6305 2RS / C3		BB
Bomba d'água (traseiro) / Bomba de agua (trasero) / Water pump (rear)				6205 2RS		BB
Bomba de óleo / Bomba de aceite / Oil pump				6304 C3		BB
Polia tensora - rodam. / Polea tensora - rodam. / Tensioner pulley - bearing				6205 2RS		BB
Ventilador (dianteiro / traseiro) / Ventilador (delantero / trasero) / Fan (front / rear)				6305		BB
Virabrequim - ponta / Cigüeñal - punta / Crankshaft spindle				6305 2RS		BB



K 124 CA (6x4 * 6x2)

Caixa de Mudanças / Caja de Cambios / Gearbox

Eixo principal / Eje principal / Main shaft				6312 C3	1304315	BB
Planetária / Planetario / Planetary				6312 C3	1304315	BB

Eixo Dianteiro / Eje Delantero / Front Axle

Roda / Rueda / Wheel				32308 BF	1382900	TRB
•				32308 F	14698	TRB
•				32309 F	14836	TRB
		•		32311 F	179427	TRB
		•		32312 F	14623	TRB

	OUT	IN		Fersa [®]	Nº OEM	
---	-----	----	---	---------------------------	--------	---

SCANIA (SA)

K 124 CA (6x4 * 6x2)

Eixo Traseiro / Eje Trasero / Rear Axle

Diferencial - coroa (dir.) / Diferencial - corona (der.) / Differential - crown (right)				33017 F	1364631	TRB
				33018 F	1309570	TRB
Diferencial - coroa (esq.) / Diferencial - corona (izq.) / Differential - crown (left)				JHM 522649 / JHM 522610	1309568	TRB
				JM 720249 / JM 720210	1105776	TRB
Diferencial - engrenagem central / Diferencial - engranaje central / Differential - central gear				32020 XF	1364630	TRB
				F 15048	345465	TRBS
Diferencial - pinhão (externo) / Diferencial - piñón (externo) / Differential - pinion (outer)				31312 F	174716	TRB
				33212 F	345833	TRB
Diferencial - pinhão int. / Diferencial - piñón (interno) / Differential - inner pinion				F 15048	315465	TRBS
Diferencial - ponta do pinhão / Diferencial - punta de piñón / Differential - pinion				F 19076	1331313	CRBS
				F 19001	1309569	CRBS
Roda / Rueda / Wheel				32207 F	202635	TRB
				32220 F	123630	TRB
				32308 BF	322747	TRB
				32308 BF	322747	TRB
				32316 F	123629	TRB
				33212 F	345833	TRB
				HM 218248 / HM 218210	291060	TRB
				HM 218248 / HM 218210	291060	TRB

Embreagem / Embrague / Clutch

Desengate / Desembrague / Clutch				6014 2RS / C3	1319737	BB
----------------------------------	--	--	--	----------------------	---------	----

K 124 EB (4X2 * 6X2) * K 124 IB (4X2 * 6X2 * 8X2)

Caixa de Mudanças / Caja de Cambios / Gearbox

Eixo intermediário (dir.) / Eje intermedio (der.) / Intermediate shaft (right)				30312 F		TRB
Eixo primário / Eje primario / Primary shaft				30314 F		TRB
Eixo secundário (dir.) / Eje secundario (der.) / Secondary shaft (right)				30314 F		TRB

K 94 IB (4X2)

Caixa de Mudanças / Caja de Cambios / Gearbox

Caixa auxiliar - eixo entrada (dianteiro) / Caja auxiliar - eje entrada (delantero) / Auxiliar box - input shaft (front)			G 660	6411 NR / C3		BB
Caixa auxiliar - eixo intermediário (dianteiro) / Caja auxiliar - eje intermedio (delantero) / Auxiliar box - intermediate shaft (front)			G 660	6409 NR / C3		BB
Caixa auxiliar - eixo saída (traseiro) / Caja auxiliar - eje salida (trasero) / Auxiliar box - output shaft (rear)			G 660	6311 NR / C3		BB
Eixo intermediário (dianteiro) / Eje intermedio (delantero) / Intermediate shaft (front)			G 655 / G 505	6407 C3		BB
			G 660 / 670 / 671 / 672	6409 C3		BB
Eixo intermediário (dir.) / Eje intermedio (der.) / Intermediate shaft (right)			310 - GR 801 K 94 IB (4X2) NB * GR 801 P 94 CB (6X4) 260 * P 94 DB (6X2), P 94 GA / GB (4X2) 260 * P 94 DB (4X2) 220 / 260	30312 F		TRB

	OUT	IN		Fersa [®]	Nº OEM	
---	-----	----	---	---------------------------	--------	---

SCANIA (SA)

K 94 IB (4X2)

Eixo intermediário (traseiro) / Eje intermedio (trasero) / Intermediate shaft (rear)			G 655 / G 505	6309 NR / C3		BB
			G 660 / 670 / 671 / 672	6409 NR / C3		BB
Eixo primário / Eje primario / Primary shaft			310 - GR 801 K 94 IB (4X2) NB * GR 801 P 94 CB (6X4) 260 * P 94 DB (6X2), P 94 GA / GB (4X2) 260 * P 94 DB (4X2) 220 / 260	30314 F		TRB
			G 655 / G 505	6311 NR / C3		BB
			G 660 / 670 / 671 / 672	6411 NR / C3		BB
Eixo secundário (dir.) / Eje secundario (der.) / Secondary shaft (right)			310 - GR 801 K 94 IB (4X2) NB * GR 801 P 94 CB (6X4) 260 * P 94 DB (6X2), P 94 GA / GB (4X2) 260 * P 94 DB (4X2) 220 / 260	30314 F		TRB
			G 655 / G 505	6311 NR / C3		BB
Eixo secundário (traseiro) / Eje secundario (trasero) / Secondary shaft (rear)			G 655 / G 505	6311 NR / C3		BB
			G 660 / 670 / 671 / 672	6411 NR / C3		BB
Planetário - eixo de saída (dianteiro) / Planetario - eje de salida (delantero) / Planetary - output shaft (front)			G 670 / 671 / 672	6015 Z		BB
Planetário - eixo de saída (traseiro) / Planetario - eje de salida (trasero) / Planetary - output shaft (rear)			G 670 / 671 / 672	6311		BB
Cardan / Cardan / Cardan						
Apoio / Apoyo / Support			G 655 / G 505	6211		BB
Eixo Dianteiro / Eje Delantero / Front Axle						
Pino manga de eixo / Perno maestro de eje / King pin shaft				31309 F		TRB
Eixo Traseiro / Eje Trasero / Rear Axle						
Diferencial - caixa satélite lat. (dir.) / Diferencial - caja satélite - lat. (der.) / Differential - satellit box (right)				32313 BF		TRB
Diferencial - coroa lateral (dir. / esq.) / Diferencial - corona lateral (der. / izq.) / Differential - crown gear (right / left)				30217 F		TRB
Diferencial - eixo reduzida (dir. / esq.) / Diferencial - eje reducción (der. / izq.) / Differential - reduction shaft (right / left)				30217 F		TRB
Diferencial - pinhão (dianteiro / traseiro) / Diferencial - piñón (delantero / trasero) / Differential - pinion (front / rear)				31312 F		TRB
Diferencial - pinhão (dianteiro) / Diferencial - piñón (delantero) / Differential - pinion (front)				31312 F		TRB
Diferencial - pinhão (traseiro) / Diferencial - piñón (trasero) / Differential - pinion (rear)				31314 F		TRB
Embreagem / Embrague / Clutch						
Alavanca de acionamento / Palanca de accionamiento / Drive lever				6201 ZZ		BB
Apoio / Apoyo / Support				6305 2RS		BB
Motor / Motor / Engine						
Alternador (dianteiro) / Alternador (delantero) / Alternator (front)				6202 2RS / C3		BB
Alternador (traseiro) / Alternador (trasero) / Alternator (rear)				6201 2RS / C3		BB
Bomba d'água (dianteiro) / Bomba de agua (delantero) / Water pump (front)			L, LS, B 75	6204		BB
			L, LS, B 75	6305		BB
Bomba d'água (traseiro) / Bomba de agua (trasero) / Water pump (rear)				6205		BB
Bomba de óleo / Bomba de aceite / Oil pump				6304 C3		BB

	OUT	IN		Fersa®	Nº OEM	
---	-----	----	---	---------------	--------	---

SCANIA (SA)

K 94 IB (4X2)

Bomba injetora (dianteiro) / Bomba inyectora (delantero) / Injection pump (front)				6207 C3		BB
Bomba injetora (traseiro) / Bomba inyectora (traseiro) / Injection pump (rear)				6207 NR		BB
Compressor (dianteiro) / Compresor (delantero) / Compressor (front)				6207 C3		BB
Compressor (traseiro) / Compresor (traseiro) / Compressor (rear)				6011 / C3		BB
Polia tensora - rolam. / Polea tensora - rodam. / Tensioner pulley - bearing			B 75 / 76	6205 RS		BB

Tomada de Força / Toma de Fuerza / Power Take-off

Eixo de saída (dianteiro) / Eje de salida (delantero) / Output shaft (front)			G 660	6207 C3		BB
Eixo intermediário (traseiro) / Eje intermedio (traseiro) / Intermediate shaft (rear)			G 660	6208		BB

P 93 * R 113 * R 143 * T 113

Caixa de Mudanças / Caja de Cambios / Gearbox

Eixo secundário (dianteiro) / Eje secundario (delantero) / Secondary shaft (front)				33208 F	284843	TRB
--	--	--	--	----------------	--------	-----

Cardan / Cardan / Cardan

Suporte / Soporte / Support				6211	14093	BB
-----------------------------	--	--	--	-------------	-------	----

Direção / Dirección / Steering

Bomba / Bomba / Pump				6004	144280	BB
----------------------	--	--	--	-------------	--------	----

Eixo Dianteiro / Eje Delantero / Front Axle

Roda / Rueda / Wheel	•			32308 F	14698	TRB
	•			32309 F	14623	TRB
		•		32311 F	179427	TRB
		•		32312 F	14836	TRB

Eixo Traseiro / Eje Trasero / Rear Axle

Diferencial - coroa lateral (dir. / esq.) / Diferencial - corona lateral (der. / izq.) / Differential - crown gear (right / left)				30217 F	174717	TRB
Diferencial - lateral coroa (esq.) / Diferencial - lateral corona (izq.) / Differential - crown gear (left)				JHM 522649 / JHM 522610	1309568	TRB
Diferencial - pinhão (dianteiro) / Diferencial - piñón (delantero) / Differential - pinion (front)				31312 F	174716	TRB
				F 15046	194050	TRBS
Diferencial - pinhão (traseiro) / Diferencial - piñón (traseiro) / Differential - pinion (rear)				F 15048	315465	TRBS
Roda / Rueda / Wheel				32020 XF	274114	TRB
				32218 F	14835	TRB
	•			32308 F	14698	TRB
				32309 F	14623	TRB
		•		32311 F	179427	TRB
		•		32312 F	14836	TRB

Embreagem / Embrague / Clutch

Desengate / Desembrague / Clutch				6014 2RS	215139	BB
----------------------------------	--	--	--	-----------------	--------	----

Motor / Motor / Engine

Bomba d'água (dianteiro) / Bomba de agua (delantero) / Water pump (front)				6305 2RS / C3	258267	BB
Bomba d'água (traseiro) / Bomba de agua (traseiro) / Water pump (rear)				6205 2RS	228836	BB

	OUT	IN		Fersa®	N° OEM	
---	-----	----	---	---------------	--------	---

VOLKSWAGEN (NA & CA)

15-210

Direção / Dirección / Steering

Bomba direção hidráulica / Bomba dirección hidráulica / Hydraulic steering pump				30206 F	607155	TRB
Bomba direção hidráulica (dianteira) / Bomba dirección hidráulica (delantera) / Hydraulic steering pump (front)				30203 F		TRB

Eixo Dianteiro / Eje Delantero / Front Axle

Roda / Rueda / Wheel	•			3782 / 3720	TMJ407628 / 2S0498625A	TRB
----------------------	---	--	--	--------------------	------------------------	-----

17-210

Eixo Dianteiro / Eje Delantero / Front Axle

Roda / Rueda / Wheel		•		HM 212049 / HM 21201111	2RH / 498628	TRB
----------------------	--	---	--	--------------------------------	--------------	-----

Eixo Traseiro / Eje Trasero / Rear Axle

Roda / Rueda / Wheel	•		RS 23-155 / RS 23-160 / RS23-240	580 / 572	2RH / 598313A	TRB
		•	RS 23-155 / RS 23-160 / RS23-240	594 A / 592 A	T12 / 501315A / 2S0598287B	TRB
				F 15156	2TO / 501287A	TRBS
	•			55206 C / 55437	2RH / 598313	TRB
		•		32218 F	2TO / 501287	TRB

23-250

Direção / Dirección / Steering

Bomba direção hidráulica (dianteira) / Bomba dirección hidráulica (delantera) / Hydraulic steering pump (front)				30203 F		TRB
---	--	--	--	----------------	--	-----

Eixo Traseiro / Eje Trasero / Rear Axle

Diferencial - lateral coroa / Diferencial - lateral corona / Differential - crown gear				JM 716649 / JM 716610		TRB
Roda / Rueda / Wheel	•			55206 C / 55437	2RH / 598313	TRB
		•		32218 F	2TO / 501287	TRB
				F 15156	2TO / 501287A	TRBS

Motor / Motor / Engine

Alternador / Alternador / Alternator				62201 2RS / C3		BB
Bomba injetora y ventilador / Bomba de inyección y ventilador / Injection pump & fan				30204 F	7700502547	TRB

4-140210

Direção / Dirección / Steering

Bomba direção hidráulica / Bomba dirección hidráulica / Hydraulic steering pump				30206 F	607155	TRB
Bomba direção hidráulica (dianteira) / Bomba dirección hidráulica (delantera) / Hydraulic steering pump (front)				30203 F		TRB

8-150

Eixo Dianteiro / Eje Delantero / Front Axle

Roda / Rueda / Wheel	•			15106 / 15250X	2TA / 498628A	TRB
----------------------	---	--	--	-----------------------	---------------	-----

Eixo Traseiro / Eje Trasero / Rear Axle

Roda / Rueda / Wheel	•			HM 807046 / HM 807010	2TA / 525271	TRB
		•		3982 / 3920	2TA / 598313	TRB





VOLKSWAGEN (SA)

17-180 * 17-210 * 17-210 OD * 17-210 EOD * 17-220 * 17-220 Tractor * 17-240 OT * 17-250 Constellation * 17-250 OE * 17-260 EOT *
 17-300 * 17-310 TITAN * 17-230 EOD

Eixo Dianteiro / Eje Delantero / Front Axle

Roda / Rueda / Wheel	•			3782 / 3720	TMJ407628 / 2S0498625A	TRB
		•		HM 212049 / HM 212011	2RH / 498628	TRB

Eixo Traseiro / Eje Trasero / Rear Axle

Roda / Rueda / Wheel	•			580 / 572	2RH598313A	TRB
		•		594 A / 592 A	T12 / 501315A / 2S0598287B	TRB

22-140 * 22-210 * 23-210 * 23-220 * 23-250 E * 23-310 TITAN

Eixo Dianteiro / Eje Delantero / Front Axle

Roda / Rueda / Wheel	•			3782 / 3720	TMJ407628	TRB
		•		HM 212049 / HM 212011	2RH / 498628	TRB

Eixo Traseiro / Eje Trasero / Rear Axle

Diferencial / Diferencial / Differential				JM 716649 / JM 716610		TRB
Roda / Rueda / Wheel	•			580 / 572	2RH598313A	TRB
		•		594 / 592 A	T12 / 501315A	TRB

Motor / Motor / Engine

Alternador (dianteiro) / Alternador (delantero) / Alternator (front)				6303 2RS / C3	2994206	BB
Alternador (traseiro) / Alternador (trasero) / Alternator (rear)				6201 2RS / C3	2994207	BB
Bomba injetora (dianteiro) / Bomba injetora (delantero) / Injection pump (front)				30203 F		TRB
Bomba injetora (traseiro) / Bomba injetora (trasero) / Injection pump (rear)				30204 F		TRB

7-100 * 8-120 * 8-140 (CE*CO) * 8-150 * 9-150 OD

Caixa de Mudanças / Caja de Cambios / Gearbox

Eixo intermediário (dianteiro / traseiro) / Eje Intermedio (delantero / trasero) / Intermediate shaft (front / rear)			8-120 MWM 4.10 NA * MWM 4.10 T (8-140, 8-140 CO / CE, 8-150) * 9-150 OD (MWM 4.10 TCA) * Eaton FSO 4305 A (8-120, 8-140, 8-140 CO / CE, 8-150, 9-150 OD)	25877 / 25821		TRB
Eixo primário / Eje primario / Primary shaft			8-120 MWM 4.10 NA * MWM 4.10 T (8-140, 8-140 CO / CE, 8-150) * 9-150 OD (MWM 4.10 TCA) * Eaton FSO 4305 A (8-120, 8-140, 8-140 CO / CE, 8-150, 9-150 OD)	M 802048 / M 802011		TRB
Eixo secundário / Eje secundario / Secondary shaft			8-120 MWM 4.10 NA * MWM 4.10 T (8-140, 8-140 CO / CE, 8-150) * 9-150 OD (MWM 4.10 TCA) * Eaton FSO 4305 A (8-120, 8-140, 8-140 CO / CE, 8-150, 9-150 OD)	25581 / 25520		TRB

Eixo Traseiro / Eje Trasero / Rear Axle

Diferencial - coroa lateral (dir. / esq.) / Diferencial - corona lateral (der. / izq.) / Differential - crown gear (right / left)			6-80, 6-90, 6-90 (P,S) * 8-120 MWM 4.10 NA * 8-150 MWM 4.10 T * 9-150 OD	387 A / 382 A		TRB
			MWM 4.10 TCA * Dana 480 (8-120, 8-150, 9-150 OD)	387 A / 382 A		TRB

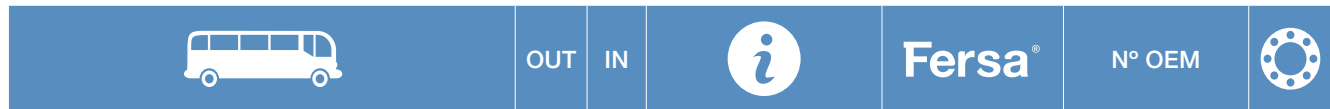

VOLVO (NA & CA)

7550

Caixa de Mudanças / Caja de Cambios / Gearbox

Contraeixo / Contraeje / Countershaft				33212 F	1652563	TRB
Coroa direita / Corona derecha / Right gear,				30217 F	184459	TRB
Flecha de controle principal / Flecha de control principal / Main control shaft				32017 XF	184623	TRB
				32312 F	14836	TRB
				32212 F	1652099	TRB

Eixo Dianteiro / Eje Delantero / Front Axle

Roda / Rueda / Wheel		•		39580 / 39520	184088	TRB
----------------------	--	---	--	----------------------	--------	-----

Eixo Traseiro / Eje Trasero / Rear Axle

Diferencial (esq.) / Diferencial (izq.) / Differential (left)				33017 F		TRB
Diferencial - flecha intermediária / Diferencial - flecha intermedia / Differential - intermediate shaft				32212 F	1652099	TRB
Diferencial / Diferencial / Differential				687 / 672	181279	TRB
				9285 / 9220	184636	TRB
				H 913842 / H 913810	184634	TRB
Roda / Rueda / Wheel	•			663 / 653	6889594	TRB
		•		683 / 672	6889593	TRB

Motor / Motor / Engine

Alternador / Alternador / Alternator				62201 2RS / C3	244328	BB
				JF 4549 / JF 4510	1656104	TRB

9700

Caixa de Mudanças / Caja de Cambios / Gearbox

Eixo intermediário / Eje intermedio / Intermediate shaft				33212 F	1652563	TRB
				32212 F	1652099	TRB
				33889 / 33822	6635263	TRB
				32312 F	14836	TRB
				32017 XF	184623	TRB

Eixo Traseiro / Eje Trasero / Rear Axle

Diferencial - direção coroa / Diferencial - corona de dirección / Differential - crown direction				30217 F	184459	TRB
Diferencial (esq.) / Diferencial (izq.) / Differential (left)				33017 F		TRB
Diferencial / Diferencial / Differential				33021 F	3152068	TRB
				64450 / 64700	81241411	TRB
Roda / Rueda / Wheel	•			663 / 653	6889594	TRB
		•		683 / 672	6889593	TRB

Motor / Motor / Engine

Alternador / Alternador / Alternator				62201 2RS / C3	244328	BB
				JF 4549 / JF 4510	1656104	TRB

Busscar dos y tres ejes

Eixo Dianteiro / Eje Delantero / Front Axle

Roda / Rueda / Wheel	•			3782 / 3720	807949	TRB
		•		HM 212049 / HM 212011	2RH / 498628	TRB

Eixo Traseiro / Eje Trasero / Rear Axle

Diferencial - nariz pinhão / Diferencial - nariz piñón / Differential - pinion			Rockwell RC-23-160: 1706 / 1708 / 1712 / 1823 / 1825 / 1892 / 1897 / 1928 / 1929	F 19033		CRBS
--	--	--	---	----------------	--	------

	OUT	IN		Fersa [®]	N° OEM	
---	-----	----	---	---------------------------	--------	---

VOLVO (NA & CA)

Busscar dos y tres ejes

Diferencial - pinhão cabeça / Diferencial - piñón cabeza / Differential - pinion head			Rockwell RC-23-160: 1706 / 1708 / 1712 / 1823 / 1825 / 1892 / 1897 / 1928 / 1929	9278 / 9220		TRB
Diferencial - pinhão cola / Diferencial - piñón cola / Differential - rear pinion			Rockwell RC-23-160: 1706 / 1708 / 1712 / 1823 / 1825 / 1892 / 1897 / 1928 / 1929	HM 813843 / HM 813810		TRB
Diferencial (dir.) / Diferencial (der.) / Differential (right)			Rockwell RC-23-160 1708 / 1712 / 1823 / 1825 / 1892 / 1897 / 1928 / 1929	52400 / 52618		TRB
Diferencial / Diferencial / Differential				594 A / 592 A	183704	TRB
Roda / Rueda / Wheel	•			580 / 572	003 981 14 05	TRB
		•		594 A / 592 A	183704	TRB

C 10 * C 11

Eixo Dianteiro / Eje Delantero / Front Axle

Roda / Rueda / Wheel	•		10,000 lb.	3782 / 3720	807949	TRB
		•	10,000 lb.	HM 212047 / HM 212011	C4TA1215B	TRB
	•		12,000 lb.	3782 / 3720	807949	TRB
		•	12,000 lb.	HM 212049 / HM 212011	2RH / 498628	TRB

Eixo Traseiro / Eje Trasero / Rear Axle

Diferencial - esquerdo - piñão (cola) / Diferencial - izquierdo - piñón (cola) / Differential - left pinion (rear)			Meritor RS-21-230	HM 804846 / HM 804810		TRB
Diferencial (esq.) / Diferencial (izq.) / Differential (left)			Meritor RS-21-230	52400 / 52618		TRB
Diferencial - pinhão (cabeza - cola) / Diferencial - piñón (cabeza / cola) / Differential - pinion head (rear)			Meritor RS-21-230	55200 C / 55437		TRB
Diferencial (dir.) / Diferencial (der.) / Differential (right)			Meritor RS-21-230	JM 716649 / JM 716610		TRB
Roda / Rueda / Wheel	•		21,000 lb.	580 / 572	003 981 14 05	TRB
		•	21,000 lb.	594 A / 592 A	183704	TRB

C 11R * C 12R

Caixa de Mudanças / Caja de Cambios / Gearbox

				25590 / 25522	B7T1201A / E7HZ7K228A	TRB
			Fuller FS 6406 A No. Fuller 658981 / 660181	3782 / 3720	807949	TRB
			Fuller FS 6406 A No. Fuller 675250 / 742259	39590 / 39520		TRB
			Fuller FS 6406 A	31594 / 31520	9415470 / 477080	TRB
			Fuller FS 6406 A No. Fuller 711123 / 5202047	45284 / 45220		TRB

Eixo Dianteiro / Eje Delantero / Front Axle

Roda / Rueda / Wheel	•		10,000 lb.	3782 / 3720	807949	TRB
		•	10,000 lb.	HM 212047 / HM 212011	C4TA1215B	TRB
	•		12,000 lb.	3782 / 3720	807949	TRB
		•	12,000 lb.	HM 212049 / HM 212011	2RH / 498628	TRB

Eixo Traseiro / Eje Trasero / Rear Axle

Diferencial - (dir. / esq.) / Diferencial - (der. / izq.) / Differential (right / left)			Meritor RS-21- 145 : 1558 / 1879 1676 / 1785 / 1850 / 1851 1865 / 1885	JM 716649 / JM 716610		TRB
---	--	--	--	----------------------------------	--	-----

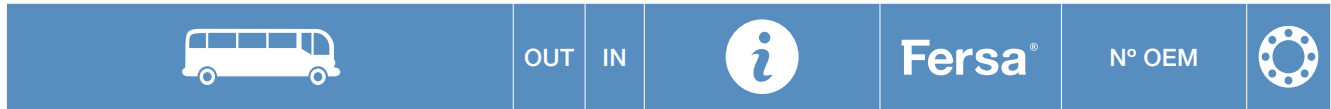

VOLVO (NA & CA)

C 11R * C 12R

Diferencial (esq.) / Diferencial (izq.) / Differential (left)			Meritor RS-21-230	52400 / 52618		TRB
Diferencial - pinhão cabeça / Diferencial - piñón cabeza / Differential - pinion head			Meritor RS-21-145 : 1500 / 1558 / 1879 1676 / 1785 / 1850 / 1851 1865 / 1885	72212 C / 72487		TRB
Diferencial - pinhão cola / Diferencial - piñón cola / Differential - rear pinion			Meritor RS-21-145 : 1500 / 1558 / 1879 1676 / 1785 / 1850 / 1851 1865 / 1885	55206 C / 55437		TRB
Roda / Rueda / Wheel	•		21,000 lb.	580 / 572	003 981 14 05	TRB
		•	21,000 lb.	594 A / 592 A	183704	TRB

U 12 * U 18 Articulado

Eixo Dianteiro / Eje Delantero / Front Axle

Roda / Rueda / Wheel	•		10,000 lb.	3782 / 3720	807949	TRB
		•	10,000 lb.	HM 212047 / HM 212011	C4TA1215B	TRB
	•		12,000 lb.	3782 / 3720	807949	TRB
		•	12,000 lb.	HM 212049 / HM 212011	2RH / 498628	TRB

Eixo Traseiro / Eje Trasero / Rear Axle

Diferencial - (dir. / esq.) / Diferencial - (der. / izq.) / Differential (right / left)				32021 XF		TRB
				594 A / 592 A	183704	TRB
Diferencial - pinhão cabeça / Diferencial - piñón cabeza / Differential - pinion head				9278 / 9220		TRB
Diferencial - pinhão cola / Diferencial - piñón cola / Differential - rear pinion				HM 813843 / HM 813810		TRB
Roda / Rueda / Wheel	•		21,000 lb.	580 / 572	003 981 14 05	TRB
		•	21,000 lb.	594 A / 592 A	183704	TRB



	OUT	IN		Fersa [®]	N° OEM	
---	-----	----	---	---------------------------	--------	---

VOLVO (SA)

B 10M BR

Caixa de Mudanças / Caja de Cambios / Gearbox

Eixo intermediário (dianteiro / traseiro) / Eje Intermedio (delantero / trasero) / Intermediate shaft (front / rear)				33889 / 33822	0019809502	TRB
Eixo intermediário (dianteiro) / Eje intermedio (delantero) / Intermediate shaft (front)			S6 90 + GV90	F 15047		TRBS
Eixo intermediário (traseiro) / Eje intermedio (trasero) / Intermediate shaft (rear)			S6 90 + GV90	32309 F	1194652	TRB
Eixo primário / Eje primario / Primary shaft			S6 90	NUP 314 FMN / C3		CRB
Eixo secundário (traseiro) / Eje secundario (trasero) / Secondary shaft (rear)				32309 F	1194652	TRB
			S6 90 + GV90	6314 N / C3		BB

Cardan / Cardan / Cardan

Suporte / Soporte / Support				6209 ZZ	181774	BB
-----------------------------	--	--	--	----------------	--------	----

Direção / Dirección / Steering

Bomba servo (dianteira) / Bomba servo (delantero) / Servopump (front)				6304		BB
Bomba servo pinhão / Bomba servo piñón / Gear servopump				6006		BB

Eixo Dianteiro / Eje Delantero / Front Axle

Pino manga de eixo / Perno maestro de eje / King pin shaft				53178 / 53377		TRB
Roda / Rueda / Wheel	•			39580 / 39520	8151820	TRB

Eixo Traseiro / Eje Trasero / Rear Axle



Diferencial - coroa lateral (dir. / esq.) / Diferencial - corona lateral (der. / izq.) / Differential - crown gear (right / left)			EV-85 B	687 / 672		TRB
Diferencial - lateral coroa (dir. / esq.) / Diferencial - lateral corona (der. / izq.) / Differential - crown gear (right / left)				687 / 672	181596 / 181279	TRB
Diferencial - pinhão (dianteiro) / Diferencial - piñón (delantero) / Differential - pinion (front)			EV-85 B	H 913842 / H 913810		TRB
Diferencial - pinhão (traseiro) / Diferencial - piñón (trasero) / Differential - pinion (rear)			EV-85 B	9285 / 9220	184636	TRB
Diferencial - pinhão apoio / Diferencial - piñón apoyo / Differential - support pinion			EV-85 B	NUP 309 FM / C3	183698	CRB
Roda / Rueda / Wheel	•			663 / 653	6889594	TRB
		•		683 / 672	6889593	TRB
				687 / 672	181596 / 181279	TRB

Embreagem / Embrague / Clutch

Garfo de acionamento / Garfo de accionamiento / Drive fork				6005 2RS	183502	BB
--	--	--	--	-----------------	--------	----

Motor / Motor / Engine

Alternador (dianteiro) / Alternador (delantero) / Alternator (front)			45 A	6303 2RS / C3	183486	BB
Alternador (traseiro) / Alternador (trasero) / Alternator (rear)			115 A	6205 RS / C3	181786	BB
				62201 2RS / C3	244328	BB
			45 A	62201 2RS / C3		BB
Bomba d'água (dianteiro) / Bomba de agua (delantero) / Water pump (front)				6302	11020	BB
Bomba d'água (traseiro) / Bomba de agua (trasero) / Water pump (rear)				6205	11012	BB
Bomba injetora (dianteiro / traseiro) / Bomba inyectora (delantero / trasero) / Injection pump (front / rear)				6206	11013	BB
				6206		BB

	OUT	IN		Fersa [®]	Nº OEM	
---	-----	----	---	---------------------------	--------	---

VOLVO (SA)

B 10M BR

Bomba injetora (dianteiro) / Bomba inyectora (delantero) / Injection pump (front)				3207 B 2RS / C3	181577	BB2R
Motor de partida / Motor de arranque / Starter engine				6201 ZZ / C3	240453	BB
Polia tensora / Polea tensora / Tensioner pulley				6204	11011	BB
Retardador / Retardador / Retarder				32213 F	11076	TRB
Ventilador / Ventilador / Fan				30306 F	18528	TRB

B 10R * B 12B * B 12R * B 58 * B 58BR * B 7R * B9

Caixa de Mudanças / Caja de Cambios / Gearbox

Eixo intermediário (dianteiro / traseiro) / Eje Intermedio (delantero / trasero) / Intermediate shaft (front / rear)				33889 / 33822	0019809502	TRB
Eixo intermediário (traseiro) / Eje intermedio (trasero) / Intermediate shaft (rear)				32309 F	1194652	TRB
Eixo secundário (traseiro) / Eje secundario (trasero) / Secondary shaft (rear)				32309 F	1194652	TRB

Cardan / Cardan / Cardan

Suporte / Soporte / Support				6209 ZZ	181774	BB
-----------------------------	--	--	--	----------------	--------	----

Eixo Dianteiro / Eje Delantero / Front Axle

Roda / Rueda / Wheel	•			39580 / 39520	8151820	TRB
----------------------	---	--	--	----------------------	---------	-----

Eixo Traseiro / Eje Trasero / Rear Axle



Diferencial - lateral coroa (dir. / esq.) / Diferencial - lateral corona (der. / izq.) / Differential - crown gear (right / left)				687 / 672	181596 / 181279	TRB
Diferencial - pinhão (dianteiro) / Diferencial - piñón (delantero) / Differential - pinion (front)				H 913842 / H 913810	184634	TRB
				HM 911245 / HM 911210	184633	TRB
Diferencial - pinhão (traseiro) / Diferencial - piñón (trasero) / Differential - pinion (rear)				9285 / 9220	184636	TRB
Diferencial - pinhão apoio / Diferencial - piñón apoyo / Differential - support pinion				NUP 309 FM / C3	183698	CRB
Roda / Rueda / Wheel	•			663 / 653	6889594	TRB
		•		683 / 672	6889593	TRB
				687 / 672	181596 / 181279	TRB

Embreagem / Embrague / Clutch

Garfo / Garfo / Drive fork				6005 2RS	183502	BB
----------------------------	--	--	--	-----------------	--------	----

Motor / Motor / Engine

Alternador (dianteiro) / Alternador (delantero) / Alternator (front)				6303 2RS / C3	183486	BB
Alternador (traseiro) / Alternador (trasero) / Alternator (rear)				6205 RS / C3	181786	BB
				62201 2RS / C3	244328	BB
Bomba d'água (dianteiro) / Bomba de agua (delantero) / Water pump (front)				6302	11020	BB
Bomba d'água (traseiro) / Bomba de agua (trasero) / Water pump (rear)				6205	11012	BB
Bomba injetora (dianteiro / traseiro) / Bomba inyectora (delantero / trasero) / Injection pump (front / rear)				6206	11013	BB
Bomba injetora (dianteiro) / Bomba inyectora (delantero) / Injection pump (front)				3207 B 2RS / C3	181577	BB2R
Motor de partida / Motor de arranque / Starter engine				6201 ZZ / C3	240453	BB
Polia tensora / Polea tensora / Tensioner pulley				6204	11011	BB
Retardador / Retardador / Retarder				32213 F	11076	TRB
Ventilador / Ventilador / Fan				30306 F	18528	TRB

	OUT	IN		Fersa [®]	N° OEM	
---	-----	----	---	---------------------------	--------	---

VOLVO (SA)

B 58

Caixa de Mudanças / Caja de Cambios / Gearbox

Eixo intermediário (dianteiro / traseiro) / Eje Intermedio (delantero / trasero) / Intermediate shaft (front / rear)				33889 / 33822	0019809502	TRB
Eixo intermediário (traseiro) / Eje intermedio (trasero) / Intermediate shaft (rear)				32309 F	1194652	TRB
Eixo secundário (traseiro) / Eje secundario (trasero) / Secondary shaft (rear)				32309 F	1194652	TRB

Cardan / Cardan / Cardan

Suporte / Soporte / Support				32213 F	11076	TRB
				6009 ZZ	181467	BB
				6209 ZZ	181774	BB

Conversor de Par / Conversor de Par / Torque Converter

Eixo primário / Eje primario / Primary shaft				6209	267572	BB
				6009 C3	1528145	BB
Volante / Volante / Steering wheel				6211 C3	1528007	BB

Direção / Dirección / Steering

Bomba (dianteira) / Bomba - dianteira / Pump (front)				6304	11022	BB
--	--	--	--	-------------	-------	----

Eixo Dianteiro / Eje Delantero / Front Axle

Roda / Rueda / Wheel		•		6386 / 6320	6889591	TRB
----------------------	--	---	--	--------------------	---------	-----

Eixo Traseiro / Eje Trasero / Rear Axle



Diferencial - coroa lateral (dir. / esq.) / Diferencial - corona lateral (der. / izq.) / Differential - crown gear (right / left)				594 / 592 A	183704	TRB
				687 / 672	181596 / 181279	TRB
Diferencial - pinhão (dianteiro) / Diferencial - piñón (delantero) / Differential - pinion (front)				H 913842 / H 913810	184634	TRB
				HM 911245 / HM 911210	184633	TRB
Diferencial - pinhão (traseiro) / Diferencial - piñón (trasero) / Differential - pinion (rear)				H 913842 / H 913810	184635	TRB
				NUP 2212 F	183703	CRB
Diferencial - pinhão apoio / Diferencial - piñón apoyo / Differential - support pinion				NUP 309 FM / C3	183698	CRB
				32219 F	181086	TRB
Roda / Rueda / Wheel		•		32219 F	181086	TRB
		•		663 / 653	6889594	TRB
		•		683 / 672	181596 / 181279	TRB

Embreagem / Embrague / Clutch

Desengate / Desembrague / Clutch				6211 C3	1529321	BB
Garfo / Garfo / Drive fork				6005 2RS	183502	BB

Motor / Motor / Engine

Alternador (dianteiro) / Alternador (delantero) / Alternator (front)				6303 2RS / C3	183486	BB
Alternador (traseiro) / Alternador (trasero) / Alternator (rear)				6201 2RS / C3	183379	BB
				62201 2RS / C3	244328	BB
				6303 C3	11021	BB
				6005	18559	BB
Bomba d'água (dianteiro) / Bomba de agua (delantero) / Water pump (front)				6205	11012	BB
				6302	11020	BB
Bomba d'água (traseiro) / Bomba de agua (trasero) / Water pump (rear)				6202 2RS	1660609	BB

	OUT	IN		Fersa®	Nº OEM	
---	-----	----	---	---------------	--------	---

VOLVO (SA)

B 58

Bomba injetora (dianteiro) / Bomba inyectora (delantero) / Injection pump (front)				3207 B 2RS / C3	181577	BB2R
Bomba injetora (traseiro) / Bomba inyectora (traseiro) / Injection pump (rear)				6206	11013	BB
Compressor / Compresor / Compressor				6207	11014	BB
Motor de partida / Motor de arranque / Starter engine				6201 ZZ / C3	240453	BB
Ventilador (dianteiro / traseiro) / Ventilador (delantero / traseiro) / Fan (front / rear)				6204	11011	BB
				30306 F	18528	TRB
				6306 ZZ	18418	BB
Ventilador / Ventilador / Fan				6007	181105	BB

B 58 BR (...Chassi 304120)

Caixa de Mudanças / Caja de Cambios / Gearbox



Caixa de multiplic. - eixo secund. (traseiro) / Caja de multiplic. - eje secund. (traseiro) / Multiplic. box - secondary shaft (rear)			S6 80 + GV80	NUP 314 FMN / C3		CRB
			S6 90 + GV90 * SPCL S 1084 / 1090	NUP 314 FMN / C3		CRB
Caixa de multiplic. - engren.movida (dianteiro) / Caja de multiplic. - engran.movido (delantero) / Multiplic. box - moved gear (rear)			S6 90 + GV90 * SPCL S 1084 / 1090	F 15047		TRBS
Eixo intermediário (dianteiro / traseiro) / Eje Intermedio (delantero / trasero) / Intermediate shaft (front / rear)				33889 / 33822	0019809502	TRB
Eixo intermediário (dianteiro) / Eje intermedio (delantero) / Intermediate shaft (front)			S6 80 + GV80 * S6 90 + GV90 * SPCL S 1074 / 1081	F 15047		TRBS
			S6 90 + GV90	F 15047		TRBS
Eixo intermediário (traseiro) / Eje intermedio (trasero) / Intermediate shaft (rear)			S6 90 + GV90 * SPCL S 1074 / 1081	32309 F		TRB
			S6 90 + GV90	32309 F		TRB
				32309 F	1194652	TRB
Eixo primário / Eje primario / Primary shaft			S6 80 * S6 90 + GV90 * SPCL S 1074 / 1081	NUP 314 FMN / C3		CRB
			S6 90	NUP 314 FMN / C3		CRB
Eixo secundário (traseiro) / Eje secundario (trasero) / Secondary shaft (rear)				32309 F	1194652	TRB
			S6 80 + GV 80	32309 F		TRB
			S6 80 + GV80 * S6 90 + GV90 * SPCL S1074 / 1081	6314 N / C3		BB
			S6 90 + GV901081	6314 N / C3		BB

Cardan / Cardan / Cardan

Retardador - eixo / Retardador - eje / Retardant - shaft				32213 F		TRB
Suporte / Soporte / Support				6009 ZZ		BB
				6209 ZZ		BB
				32213 F	11076	TRB
				6009 ZZ	181467	BB
				6209 ZZ	181774	BB

Conversor de Par / Conversor de Par / Torque Converter

				6209	267572	BB
				6010 C3	1528145	BB
				6211 C3	1528007	BB

	OUT	IN		Fersa [®]	Nº OEM	
---	-----	----	---	---------------------------	--------	---

VOLVO (SA)

B 58 BR (...Chassi 304120)

Direção / Dirección / Steering

Bomba (dianteira) / Bomba - dianteira / Pump (front)				6304	11022	BB
Bomba servo (dianteira) / Bomba servo (delantero) / Servopump (front)				6304		BB

Eixo Dianteiro / Eje Delantero / Front Axle

Pino manga de eixo / Perno maestro de eje / King pin shaft				53178 / 53377		TRB
Roda / Rueda / Wheel		•		6386 / 6320	6889591	TRB

Eixo Traseiro / Eje Trasero / Rear Axle

Diferencial - coroa lateral (dir. / esq.) / Diferencial - corona lateral (der. / izq.) / Differential - crown gear (right / left)			EV-80 B * EV-81, SPCL S 1074 * Trolley Bus	594 / 592		TRB
			EV-80 B * EV-81	594 / 592		TRB
			EV-85	687 / 672		TRB
			EV-85 B	687 / 672		TRB
				594 / 592 A	183704	TRB
Diferencial - pinhão (dianteiro) / Diferencial - piñón (delantero) / Differential - pinion (front)			EV-85	H 913842 / H 913810	184634	TRB
			EV-85 B	HM 911245 / HM 911210	184633	TRB
Diferencial - pinhão (traseiro) / Diferencial - piñón (trasero) / Differential - pinion (rear)			EV-85	9285 / 9220		TRB
				H 913842 / H 913810	184635	TRB
Diferencial - pinhão apoio / Diferencial - piñón apoyo / Differential - support pinion				NUP 2212 F	183703	CRB
				NUP 309 FM / C3	183698	CRB
Roda / Rueda / Wheel		•		32219 F	181086	TRB
	•			32219 F	181086	TRB
	•			663 / 653	6889594	TRB
		•		683 / 672	181596 / 181279	TRB

Embreagem / Embrague / Clutch

Desengate / Desembrague / Clutch				6211 C3	1529321	BB
Garfo / Garfo / Drive fork				6005 2RS	183502	BB

Motor / Motor / Engine

Alternador (dianteiro) / Alternador (delantero) / Alternator (front)			35 A * 45 A	6303 2RS / C3	183486	BB
			45 A	6303 2RS / C3		BB
Alternador (traseiro) / Alternador (trasero) / Alternator (rear)				6201 2RS / C3	183379	BB
				62201 2RS / C3	244328	BB
				6303 C3	11021	BB
Bomba d'água (dianteiro) / Bomba de agua (delantero) / Water pump (front)				6005	18559	BB
				6205	11012	BB
Bomba d'água (traseiro) / Bomba de agua (trasero) / Water pump (rear)				6302	11020	BB
				6202 2RS	1660609	BB
Bomba injetora (dianteiro) / Bomba inyectora (delantero) / Injection pump (front)				3207 B 2RS / C3	181577	BB2R
Bomba injetora (traseiro) / Bomba inyectora (trasero) / Injection pump (rear)				6206	11013	BB
Compressor / Compresor / Compressor				6207	11014	BB
				6207		BB



A large, empty area of the page filled with horizontal blue lines, intended for writing or drawing.

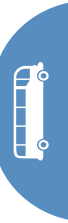

07

Bearings for Car Applications

Rolamentos para Aplicações de Veículos Leves
Rodamientos para Aplicaciones de Automoción



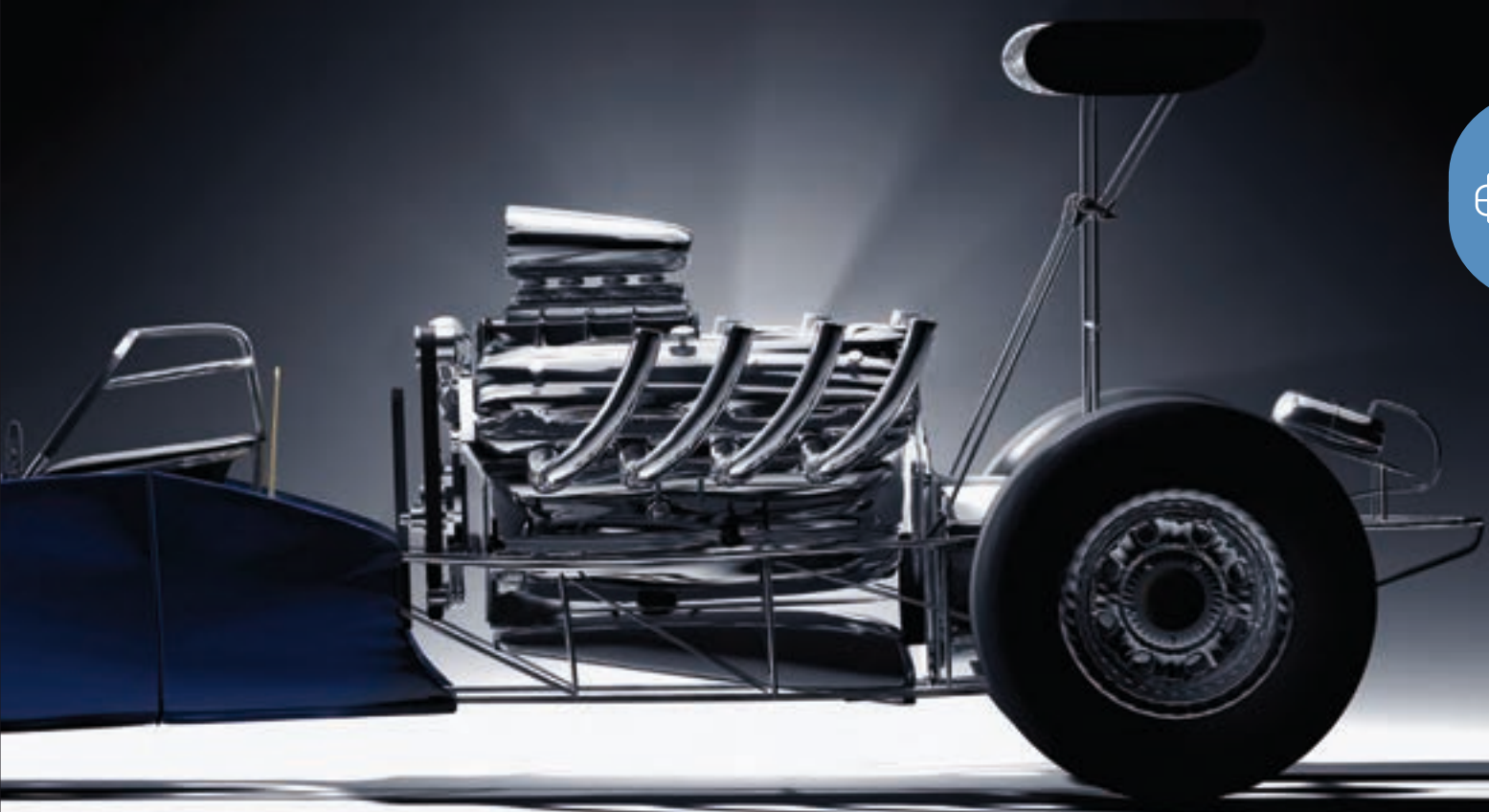

	OUT	IN		Fersa [®]	N° OEM	
---	-----	----	---	---------------------------	--------	---

ALFA ROMEO

Alfa 145

Eixo Traseiro / Eje Trasero / Rear Axle

Roda / Rueda / Wheel				KV 164	46453887	KIT
----------------------	--	--	--	---------------	----------	-----

Alfa 164

Eixo Dianteiro / Eje Delantero / Front Axle

Semi Eixo / Semi eje / Front shaft			2.0 * 3.0 V6	62206 2RS		BB
------------------------------------	--	--	--------------	------------------	--	----

Alfa 2300

Câmbio / Caja de Cambios / Gearbox

Eixo intermediário / Eje Intermediario / Intermediate shaft			B * SL * TI 4	NUP 2205	105121326000	CRB
---	--	--	---------------	-----------------	--------------	-----

Eixo intermediário (traseiro) / Eje intermedio (trasero) / Intermediate shaft (rear)			B * SL * TI 4	NJ 206	105121326000	CRB
--	--	--	---------------	---------------	--------------	-----

Cardan / Cardan / Cardan

Suporte / Soporte / Support			B * SL * TI 4	6206 2RS / C3	105391512300	BB
-----------------------------	--	--	---------------	----------------------	--------------	----

Eixo Dianteiro / Eje Delantero / Front Axle

Roda / Rueda / Wheel		•	B * SL * TI 4	30207 F	2900/62204	TRB
----------------------	--	---	---------------	----------------	------------	-----

	•		B * SL * TI 4	32304 F	2900/623120	TRB
--	---	--	---------------	----------------	-------------	-----

Eixo Traseiro / Eje Trasero / Rear Axle

Roda / Rueda / Wheel			B * SL * TI 4	6208 ZZ	102121730100	BB
----------------------	--	--	---------------	----------------	--------------	----

Motor / Motor / Engine

Alternador - polia / Alternador - polea / Alternator - pulley			B * SL * TI 4	6203 2RS / C3	28043180	BB
---	--	--	---------------	----------------------	----------	----

Ar condicionado - polia / Aire acondicionado - polea / Air conditioner - pulley			B * SL * TI 4	6203 2RS	102121014101	BB
---	--	--	---------------	-----------------	--------------	----

ASIA

Topic

Câmbio / Caja de Cambios / Gearbox

Eixo intermediário / Eje Intermediario / Intermediate shaft				6304 2RS		BB
---	--	--	--	-----------------	--	----

Eixo primário / Eje primario / Primary shaft				6307 2RS NR		BB
--	--	--	--	--------------------	--	----

Eixo secund / Eje secundario / Secondary shaft				6208 2RS		BB
--	--	--	--	-----------------	--	----

Motor / Motor / Engine

Alternador / Alternador / Alternator				6303 2RS / C3		BB
--------------------------------------	--	--	--	----------------------	--	----

Towner

Câmbio / Caja de Cambios / Gearbox

Eixo secundário (dianteiro) / Eje secundario (delantero) / Secondary shaft (front)				6303		BB
--	--	--	--	-------------	--	----

Eixo secundário (traseiro) / Eje secundario (trasero) / Secondary shaft (rear)				6303 2RS		BB
--	--	--	--	-----------------	--	----



	OUT	IN		Fersa [®]	Nº OEM	
---	-----	----	---	---------------------------	--------	---

CHRYSLER

1800

Diferencial / Diferencial / Differential

			SE * GL * Polara	LM 48548 / LM 48510	1671336	TRB
--	--	--	------------------	---------------------	---------	-----

Eixo Dianteiro / Eje Delantero / Front Axle

Roda / Rueda / Wheel		•	SE * GL * Polara	L 44649 / L 44610	02072712	TRB
----------------------	--	---	------------------	-------------------	----------	-----

Eixo Dianteiro / Eje Delantero / Front Axle

Roda / Rueda / Wheel		•		LM 67048 / LM 67010	1615339	TRB
	•		SE * GL * Polara	LM 11949 / LM 11910	1615336	TRB

Cherokee * Gran Cherokee

Diferencial / Diferencial / Differential

Coroa lateral (dir./esq.) / Lateral corona (der./izq.) / Crown gear (right/left)				LM 603049 / LM 603012		TRB
--	--	--	--	-----------------------	--	-----

Embreagem / Embrague / Clutch

Apoio / Apoyo / Support			Diesel	6302 2RS		BB
-------------------------	--	--	--------	----------	--	----

Crossfire

Eixo Dianteiro / Eje Delantero / Front Axle

Roda / Rueda / Wheel	•		3.2L * 04...05	L 68149 / L 68111		TRB
		•	3.2L * 04...05	LM 12749 / LM 12710		TRB
			3.2L * 04...05	F 16059		BBDRAC

D 100

Eixo Dianteiro / Eje Delantero / Front Axle

Roda / Rueda / Wheel		•		LM 48548 / LM 48510	2986540	TRB
	•			LM 11949 / LM 11910	1615336	TRB

Dakota

Diferencial / Diferencial / Differential

Coroa lateral (dir./esq.) / Lateral corona (der./izq.) / Crown gear (right/left)				LM 603049 / LM 603012		TRB
Coroa Lat (dir.) / Corona Lateral (der.) / Crown Gear (right)				LM 501349 / LM 501310		TRB
Coroa lat. (esq.) / Corona lateral (izq.) / Crown gear (left)				LM 501349 / LM 501310		TRB
Pinhão cônico (traseiro) / Piñón cónico (trasero) / Bevel gear (rear)				HM 88649 / HM 88610		TRB

Dart

Eixo Dianteiro / Eje Delantero / Front Axle

Roda / Rueda / Wheel		•		LM 67048 / LM 67010	1615339	TRB
	•			LM 11949 / LM 11910	1615336	TRB

Eixo Traseiro / Eje Trasero / Rear Axle

Roda / Rueda / Wheel			3.6L * 80...82	U 298 / U 261 L		U Series
			5.2L * 80...82	U 399 / U 360 L		U Series



Dart K

Eixo Dianteiro / Eje Delantero / Front Axle

Roda / Rueda / Wheel			2.2L * 84...88	F 16195		BBDRAC
----------------------	--	--	----------------	---------	--	--------

Eixo Traseiro / Eje Trasero / Rear Axle

Roda / Rueda / Wheel	•		2.2L * 82...83	L 44649 / L 44610		TRB
----------------------	---	--	----------------	-------------------	--	-----

	OUT	IN		Fersa [®]	N° OEM	
---	-----	----	---	---------------------------	--------	---

CHRYSLER

Dart K

Roda / Rueda / Wheel		•	2.2L * 82...83	LM 12749 / LM 12710		TRB
	•		2.2L * 84 -88	JL 26749 F / JL 26710		TRB
		•	2.2L * 84 -88	LM 11949 / LM 11910		TRB

Gran Sedan

Eixo Dianteiro / Eje Delantero / Front Axle

Roda / Rueda / Wheel		•		LM 67048 / LM 67010	1615339	TRB
	•			LM 11949 / LM 11910	1615336	TRB

Le Baron

Eixo Dianteiro / Eje Delantero / Front Axle

Roda / Rueda / Wheel		•		LM 67048 / LM 67010	1615339	TRB	
	•			LM 11949 / LM 11910	1615336	TRB	
			•	2.2L * 85...87	F 16195		BBDRAC
			•	2.2L T * 86...87	F 16195		BBDRAC
		•		3.7L * 1982	L 68149 / L 68111		TRB
		•		3.7L * 1982	LM 11949 / LM 11910		TRB
		•		5.9L * 80...82	L 68149 / L 68111		TRB
		•		5.9L * 80...82	LM 11949 / LM 11910		TRB

Eixo Traseiro / Eje Trasero / Rear Axle

Roda / Rueda / Wheel	•		2.2L * 83...84	JL 26749 F / JL 26710		TRB
		•	2.2L * 83...84	LM 11949 / LM 11910		TRB
	•		2.2L * 85...87	JL 26749 F / JL 26710		TRB
		•	2.2L * 85...87	LM 11949 / LM 11910		TRB
	•		2.2L T * 86...87	JL 26749 F / JL 26710		TRB
		•	2.2L T * 86...87	LM 11949 / LM 11910		TRB
	•		2.5L * 92...94	JL 26749 F / JL 26710		TRB
		•	2.5L * 92...94	LM 12749 / LM 12710		TRB
			•	3.7L * 1982	U 399 / U 360 L	
		•	5.9L * 80...82	U 399 / U 360 L		U Series

Magnum

Eixo Dianteiro / Eje Delantero / Front Axle

Roda / Rueda / Wheel		•		LM 67048 / LM 67010	1615339	TRB
	•			LM 11949 / LM 11910	1615336	TRB

New Yorker

Eixo Dianteiro / Eje Delantero / Front Axle

Roda / Rueda / Wheel			2.2L * 85...88	F 16195		BBDRAC
----------------------	--	--	----------------	---------	--	--------

	OUT	IN		Fersa [®]	N° OEM	
---	-----	----	---	---------------------------	--------	---

CHRYSLER

New Yorker

Eixo Traseiro / Eje Trasero / Rear Axle

Roda / Rueda / Wheel	●		2.2L * 85...88	JL 26749 F / JL 26710		TRB
		●	2.2L * 85...88	LM 11949 / LM 11910		TRB
	●		2.2L * 89...91	JL 26749 F / JL 26710		TRB
		●	2.2L * 89...91	LM 12749 / LM 12710		TRB

Phantom

Eixo Dianteiro / Eje Delantero / Front Axle

Roda / Rueda / Wheel			2.2L * 87...88	F 16195		BBDRAC
----------------------	--	--	----------------	---------	--	--------

Eixo Traseiro / Eje Trasero / Rear Axle

Roda / Rueda / Wheel	●		2.2L * 87...88	JL 26749 F / JL 26710		TRB
		●	2.2L * 87...88	LM 12749 / LM 12710		TRB
	●		2.2L * 1989	JL 26749 F / JL 26710		TRB
		●	2.2L * 1989	LM 12749 / LM 12710		TRB
	●		2.2L * 1989	JL 26749 F / JL 26710		TRB
		●	2.2L * 1989	LM 12749 / LM 12710		TRB

PT Cruiser

Eixo Dianteiro / Eje Delantero / Front Axle

Roda / Rueda / Wheel			2.4L * 01...09	F 16194		BBDRAC
----------------------	--	--	----------------	---------	--	--------

Shadow

Eixo Dianteiro / Eje Delantero / Front Axle

Roda / Rueda / Wheel			2.2L * 89...90	F 16195		BBDRAC
----------------------	--	--	----------------	---------	--	--------

Eixo Traseiro / Eje Trasero / Rear Axle

Roda / Rueda / Wheel	●		2.2L * 89...90	JL 26749 F / JL 26710		TRB
		●	2.2L * 89...90	LM 12749 / LM 12710		TRB
	●		2.5L * 89...94	JL 26749 F / JL 26710		TRB
		●	2.5L * 89...94	LM 12749 / LM 12710		TRB

Spirit

Eixo Traseiro / Eje Trasero / Rear Axle

Roda / Rueda / Wheel	●		2.5L * 90...94	JL 26749 F / JL 26710		TRB
		●	2.5L * 90...94	LM 12749 / LM 12710		TRB



Volare K

Eixo Dianteiro / Eje Delantero / Front Axle

Roda / Rueda / Wheel			2.2L * 86...88	F 16195		BBDRAC
----------------------	--	--	----------------	---------	--	--------

Eixo Traseiro / Eje Trasero / Rear Axle

Roda / Rueda / Wheel	●		2.2L * 86...88	JL 26749 F / JL 26710		TRB
	●	●	2.2L * 86...88	LM 12749 / LM 12710		TRB
		●	2.2L * 86...88	LM 12749 / LM 12710		TRB

	OUT	IN		Fersa®	N° OEM	
---	-----	----	---	---------------	--------	---

CITRÖEN

AX * ZX

Eixo Dianteiro / Eje Delantero / Front Axle

Roda / Rueda / Wheel			1.1 * 1.4 * 1.6 * 1.8 * 2.0L	F 16026	335017	BBDRAC
----------------------	--	--	------------------------------	----------------	--------	--------

Eixo Traseiro / Eje Trasero / Rear Axle

Roda / Rueda / Wheel			1.1 * 1.4 * 1.6 * 1.8 * 2.0L * 1.8 * 1.9L D * sim/sin/without ABS	F 15041	373021	TRBDR
----------------------	--	--	---	----------------	--------	-------

C3

Eixo Dianteiro / Eje Delantero / Front Axle

Roda / Rueda / Wheel			sim/sin/without ABS * F 16029	KF 145	335032	KIT
----------------------	--	--	----------------------------------	---------------	--------	-----

Eixo Traseiro / Eje Trasero / Rear Axle

Roda / Rueda / Wheel			1.4 * 1.6L * sim/sin/without ABS	F 15041	373021	TRBDR
----------------------	--	--	-------------------------------------	----------------	--------	-------

Xantia (2.0 8V*16V)

Eixo Direito / Eje Derecho / Right Axle

Semi Eixo Dianteiro / Semi eje delantero / Front shaft				6006 2RS		BB
--	--	--	--	-----------------	--	----

Xsara

Eixo Dianteiro / Eje Delantero / Front Axle

Roda / Rueda / Wheel			1.4 * 1.6L * 1.5L D	F 16026	332631	BBDRAC
			1.4 * 1.6 * 1.8 * 2.0L * 1.5L D * sim/sin/without ABS	F 15041	373021	TRBDR

Xsara Picasso (1.6 8V* 1.8 16V * 2.0 8V*16V)

Eixo Direito / Eje Derecho / Right Axle

Semi Eixo Dianteiro / Semi eje delantero / Front shaft				6006 2RS		BB
--	--	--	--	-----------------	--	----

ZX (1.6 8V* 1.8 8V* 2.0 8V * 2.0 16V)

Eixo Direito / Eje Derecho / Right Axle

Semi Eixo Dianteiro / Semi eje delantero / Front shaft				6006 2RS		BB
--	--	--	--	-----------------	--	----



	OUT	IN		Fersa [®]	N° OEM	
---	-----	----	---	---------------------------	--------	---

DAEWOO

Ciello

Eixo Traseiro / Eje Trasero / Rear Axle

Roda / Rueda / Wheel		•		L 45449 / L 45410	09265-29001	TRB
	•			LM 11749 / LM 11710	09267-34002	TRB

Espero

Eixo Traseiro / Eje Trasero / Rear Axle

Roda / Rueda / Wheel		•	16V	L 45449 / L 45410	09265-29001	TRB
	•		16V	LM 11749 / LM 11710	2667866	TRB

Lanos

Eixo Dianteiro / Eje Delantero / Front Axle

Roda / Rueda / Wheel			1.6L * 16 V - sim/sin/without ABS	F 16019	09267-34002	BBDRAC
----------------------	--	--	--------------------------------------	----------------	-------------	--------

Eixo Traseiro / Eje Trasero / Rear Axle

Roda / Rueda / Wheel		•	1.6L * 16 V - sim/sin/without ABS	L 45449 / L 45410	09265-29001	TRB
	•		1.6L * 16 V - sim/sin/without ABS	LM 11749 / LM 11710	2667866	TRB

Nubira

Eixo Traseiro / Eje Trasero / Rear Axle

Roda / Rueda / Wheel		•	1.6L	L 45449 / L 45410	09265-29001	TRB
	•		1.6L	LM 11749 / LM 11710	2667866	TRB

Racer



Eixo Dianteiro / Eje Delantero / Front Axle

Roda / Rueda / Wheel			1.8L sim/sin/without ABS	F 16019	09267-34002	BBDRAC
----------------------	--	--	--------------------------	----------------	-------------	--------

Eixo Traseiro / Eje Trasero / Rear Axle

Roda / Rueda / Wheel		•	1.8L	L 45449 / L 45410	09265-29001	TRB
	•		1.8L	LM 11749 / LM 11710	2667866	TRB



	OUT	IN		Fersa [®]	N° OEM	
---	-----	----	---	---------------------------	--------	---

DODGE

Atos

Eixo Dianteiro / Eje Delantero / Front Axle

Roda / Rueda / Wheel			1.0L * 01...03	F 16057		BBDRAC
			1.1L * 05...	F 16057		BBDRAC

Eixo Traseiro / Eje Trasero / Rear Axle

Roda / Rueda / Wheel	•		1.0L * 2001	L 44649 / L 44610		TRB
		•	1.0L * 2001	LM 11749 / LM 11710		TRB

Attitude

Eixo Dianteiro / Eje Delantero / Front Axle

Roda / Rueda / Wheel			1.6L * 06...	F 16057		BBDRAC
----------------------	--	--	--------------	---------	--	--------

Caravan

Eixo Traseiro / Eje Trasero / Rear Axle

Roda / Rueda / Wheel	•		89...95	L 68149 / L 68111		TRB
		•	89...95	LM 12749 / LM 12711		TRB
	•		91...95	L 68149 / L 68111		TRB
		•	91...95	LM 12749 / LM 12711		TRB

D150

Eixo Dianteiro / Eje Delantero / Front Axle

Roda / Rueda / Wheel	•		3.7L * 81...92	JL 69349 / JL 69310		TRB
		•	3.7L * 81...92	LM 12749 / LM 12711		TRB

Eixo Traseiro / Eje Trasero / Rear Axle

Roda / Rueda / Wheel	•		3.7L * 81...92	LM 104949 / LM 104911		TRB
		•	3.7L * 81...92	LM 104949 / LM 104911		TRB

D250

Eixo Dianteiro / Eje Delantero / Front Axle

Roda / Rueda / Wheel	•		5.7L * 86...93	JL 69349 / JL 69310		TRB
		•	5.7L * 86...93	LM 12749 / LM 12711		TRB

Eixo Traseiro / Eje Trasero / Rear Axle

Roda / Rueda / Wheel	•		5.7L * 86...93	LM 104949 / LM 104911		TRB
		•	5.7L * 86...93	LM 104949 / LM 104911		TRB

D350

Eixo Dianteiro / Eje Delantero / Front Axle

Roda / Rueda / Wheel	•		3.7L * 83...89	JL 69349 / JL 69310		TRB
		•	3.7L * 83...89	LM 12749 / LM 12711		TRB
	•		5.7L * 83...89	LM 501349 / LM 501310		TRB
		•	5.7L * 83...89	15101 / 15245		TRB

Eixo Traseiro / Eje Trasero / Rear Axle

Roda / Rueda / Wheel	•		3.7L * 83...89	LM 104949 / LM 104911		TRB
		•	3.7L * 83...89	LM 104949 / LM 104911		TRB

	OUT	IN		Fersa [®]	Nº OEM	
---	-----	----	---	---------------------------	--------	---

DODGE

D350

Roda / Rueda / Wheel	●		5.7L * 83...89	45291 / 45220		TRB
		●	5.7L * 83...89	LM 104949 / LM 104911		TRB

H100

Eixo Dianteiro / Eje Delantero / Front Axle

Roda / Rueda / Wheel	●		2.4L * 03...05	LM 48548 / LM 48510		TRB
		●	2.4L * 03...05	M 12649 / M 12610		TRB
	●		2.5L TDI * 06...	LM 48548 / LM 48510		TRB
		●	2.5L TDI * 06...	M 12649 / M 12610		TRB

Eixo Traseiro / Eje Trasero / Rear Axle

Roda / Rueda / Wheel			2.4L * 03...05	U 399 / U 360 L		U Series
			2.5L TDI * 06...	U 399 / U 360 L		U Series

Neon

Eixo Dianteiro / Eje Delantero / Front Axle

Roda / Rueda / Wheel				F 16197		BBDRAC
				F 16198		BBDRAC

Ram 1500

Eixo Dianteiro / Eje Delantero / Front Axle

Roda / Rueda / Wheel	●		3.9L * 95...99	LM 48548 / LM 48510		TRB
		●	3.9L * 95...99	M 12649 / M 12610		TRB

Ram 2500

Eixo Dianteiro / Eje Delantero / Front Axle

Roda / Rueda / Wheel	●		5.2L * 00...02	JL 69349 / JL 69310		TRB
		●	5.2L * 00...02	LM 12749 / LM 12711		TRB
	●		5.2L * 97...02	LM 501349 / LM 501310		TRB
		●	5.2L * 97...02	15101 / 15245		TRB
	●		5.9L * 95...01	LM 501349 / LM 501310		TRB
		●	5.9L * 95...01	15101 / 15245		TRB

Eixo Traseiro / Eje Trasero / Rear Axle

Roda / Rueda / Wheel	●		4.7L * 02...	28682 / 28622		TRB
		●	4.7L * 02...	LM 104949 / LM 104911		TRB
	●		4.7L * 02...05	28682 / 28622		TRB
		●	4.7L * 02...05	LM 104949 / LM 104911		TRB
	●		4.7L * 06...	28682 / 28622		TRB
		●	4.7L * 06...	LM 104949 / LM 104911		TRB
	●		5.2L * 00...02	28682 / 28622		TRB
		●	5.2L * 00...02	LM 104949 / LM 104911		TRB
	●		5.2L * 97...99	28682 / 28622		TRB
		●	5.2L * 97...99	LM 104949 / LM 104911		TRB
	●		5.2L * 97...99	39585 / 39520		TRB
		●	5.2L * 97...99	LM 506849 / LM 506810		TRB
	●		5.7L * 03...	28682 / 28622		TRB
		●	5.7L * 03...	LM 104949 / LM 104911		TRB

	OUT	IN		Fersa [®]	N° OEM	
---	-----	----	---	---------------------------	--------	---

DODGE

Ram 2500

Roda / Rueda / Wheel	•		5.7L * 03...05	28682 / 28622		TRB
		•	5.7L * 03...05	LM 104949 / LM 104911		TRB
	•		5.7L * 06...	28682 / 28622		TRB
		•	5.7L * 06...	LM 104949 / LM 104911		TRB
	•		5.9L * 00...02	39585 / 39520		TRB
		•	5.9L * 00...02	LM 506849 / LM 506810		TRB
	•		5.9L * 06...09	39585 / 39520		TRB
		•	5.9L * 06...09	LM 506849 / LM 506810		TRB
	•		5.9L * 06...09	28682 / 28622		TRB
		•	5.9L * 06...09	LM 104949 / LM 104911		TRB
	•		5.9L * 95...99	28682 / 28622		TRB
		•	5.9L * 95...99	LM 104949 / LM 104911		TRB
	•		5.9L * 95...99	39585 / 39520		TRB
		•	5.9L * 95...99	LM 506849 / LM 506810		TRB

Ram 3500

Eixo Traseiro / Eje Trasero / Rear Axle

Roda / Rueda / Wheel	•		5.9L * 95...99	45291 / 45220		TRB
		•	5.9L * 95...99	LM 104949 / LM 104911		TRB
	•		5.9L * 00...02	45291 / 45220		TRB
		•	5.9L * 00...02	LM 104949 / LM 104911		TRB

Ram 4000

Eixo Traseiro / Eje Trasero / Rear Axle

Roda / Rueda / Wheel	•		5.7L * 05...09	39585 / 39520		TRB
		•	5.7L * 05...09	LM 104949 / LM 104911		TRB
	•		5.9L * 95...99	45291 / 45220		TRB
		•	5.9L * 95...99	LM 104949 / LM 104911		TRB
	•		5.9L * 00...02	45291 / 45220		TRB
		•	5.9L * 00...02	LM 104949 / LM 104911		TRB
	•		5.9L * 06...	39585 / 39520		TRB
		•	5.9L * 06...	LM 104949 / LM 104911		TRB

Ram Charger

Eixo Dianteiro / Eje Delantero / Front Axle

Roda / Rueda / Wheel	•		5.2L * 99...01	LM 501349 / LM 501310		TRB
		•	5.2L * 99...01	15101 / 15245		TRB
	•		5.9L * 86...01	LM 501349 / LM 501310		TRB
		•	5.9L * 86...01	15101 / 15245		TRB

Ram Van * Wagon 1500

Eixo Dianteiro / Eje Delantero / Front Axle

Roda / Rueda / Wheel	•		3.9L * 95...99	LM 48548 / LM 48510		TRB
----------------------	---	--	----------------	---------------------	--	-----

	OUT	IN		Fersa [®]	N° OEM	
---	-----	----	---	---------------------------	--------	---

DODGE

Ram Van * Wagon 1500

Roda / Rueda / Wheel		•	3.9L * 95...99	M 12649 / M 12610		TRB
	•		5.2L * 96...99	LM 501349 / LM 501310		TRB
		•	5.2L * 96...99	15101 / 15245		TRB
	•		5.2L * 00...02	JL 69349 / JL 69310		TRB
		•	5.2L * 00...02	LM 12749 / LM 12711		TRB
	•		5.2L * 96...02	LM 501349 / LM 501310		TRB
		•	5.2L * 96...02	15101 / 15245		TRB
	•		5.9L * 97...02	LM 501349 / LM 501310		TRB
		•	5.9L * 97...02	15101 / 15245		TRB
		•	5.2L * 96...02	15101 / 15245		TRB
	•		5.9L * 97...02	LM 501349 / LM 501310		TRB
		•	5.9L * 97...02	15101 / 15245		TRB

Eixo Traseiro / Eje Trasero / Rear Axle

Roda / Rueda / Wheel	•		5.2L * 96...02	45291 / 45220		TRB
		•	5.2L * 96...02	LM 104949 / LM 104911		TRB
	•		5.9L * 97...02	45291 / 45220		TRB
		•	5.9L * 97...02	LM 104949 / LM 104911		TRB

FAW

F1 Sedan

Eixo Traseiro / Eje Trasero / Rear Axle



Roda / Rueda / Wheel	•		1.0L * 08...10	LM 11949 / LM 11910		TRB
		•	1.0L * 08...10	L 45449 / L 45410		TRB

F4

Eixo Traseiro / Eje Trasero / Rear Axle

Roda / Rueda / Wheel	•		1.4L * 08...10	LM 11949 / LM 11910		TRB
		•	1.4L * 08...10	L 45449 / L 45410		TRB



	OUT	IN		Fersa [®]	N° OEM	
---	-----	----	---	---------------------------	--------	---

FIAT

147

Motor / Motor / Engine

Alternador (dianteiro) / Alternador (delantero) / Alternator (front)			Bosch	6203 2RS / C3		BB
Alternador (traseiro) / Alternador (trasero) / Alternator (rear)			Bosch	6201 2RS / C3		BB
			Bosch 70A	62201 2RS / C3		BB
Alternador - lado coletor / Alternador - lado colector / Alternator - manifold				6201 2RS / C3		BB
				62201 2RS / C3		BB
Alternador - lado polia / Alternador - lado polea / Alternator - pulley				6203 2RS / C3		BB

Brava

Diferencial / Diferencial / Differential

Coroa lateral (dir./esq.) / Lateral corona (der./izq.) / Crown gear (right/left)			1.8 16V	32009 XF		TRB
--	--	--	---------	----------	--	-----

Eixo Dianteiro / Eje Delantero / Front Axle

Roda / Rueda / Wheel				F 16013		BBDRAC
----------------------	--	--	--	---------	--	--------

Eixo Traseiro / Eje Trasero / Rear Axle

Roda / Rueda / Wheel				KV 164		KIT
----------------------	--	--	--	--------	--	-----

Doblò

Diferencial / Diferencial / Differential

Coroa lateral (dir./esq.) / Lateral corona (der./izq.) / Crown gear (right/left)			1.8 16V	32009 XF		TRB
--	--	--	---------	----------	--	-----

Eixo Dianteiro / Eje Delantero / Front Axle

Roda / Rueda / Wheel				F 16013		BBDRAC
----------------------	--	--	--	---------	--	--------

Eixo Traseiro / Eje Trasero / Rear Axle

Roda / Rueda / Wheel				KV 164		KIT
----------------------	--	--	--	--------	--	-----

Ducato

Eixo / Eje / Shaft

Coroa - (dir./esq.) / Corona (der./izq.) / Crown Gear (right/left)				32010 XF		TRB
--	--	--	--	----------	--	-----

Elba

Eixo Dianteiro / Eje Delantero / Front Axle

Roda / Rueda / Wheel				F 16013		BBDRAC
----------------------	--	--	--	---------	--	--------

Motor / Motor / Engine

Alternador (dianteiro) / Alternador (delantero) / Alternator (front)			Bosch	6203 2RS / C3		BB
Alternador - lado coletor / Alternador - lado colector / Alternator - manifold				6201 2RS / C3		BB
				62201 2RS / C3		BB
Alternador - lado polia / Alternador - lado polea / Alternator - pulley				6203 2RS / C3		BB
				62201 2RS / C3		BB
Alternador (traseiro) / Alternador (trasero) / Alternator (rear)			Bosch	6201 2RS / C3		BB
			Bosch 70A	62201 2RS / C3		BB
Bomba d'água (dir.) / Bomba de agua (der.) / Water pump (right)			1.6	62302 2RS / C3		BB
Bomba d'água (esq.) / Bomba de agua (izq.) / Water pump (left)			1.6	62202 2RS / C3		BB

Fiorino

Eixo Dianteiro / Eje Delantero / Front Axle

Roda / Rueda / Wheel				F 16013		BBDRAC
----------------------	--	--	--	---------	--	--------

	OUT	IN		Fersa®	N° OEM	
---	-----	----	---	---------------	--------	---

FIAT

Fiorino

Motor / Motor / Engine

Alternador (dianteiro) / Alternador (delantero) / Alternator (front)			Bosch	6203 2RS / C3		BB
Alternador - lado coletor / Alternador - lado colector / Alternator - manifold				6201 2RS / C3		BB
				62201 2RS / C3		BB
Alternador - lado polia / Alternador - lado polea / Alternator - pulley				6203 2RS / C3		BB
Alternador (traseiro) / Alternador (trasero) / Alternator (rear)			Bosch	6201 2RS / C3		BB
			Bosch 70A	62201 2RS / C3		BB
Bomba d'água (dir.) / Bomba de agua (der.) / Water pump (right)			1.6	62302 2RS / C3		BB
Bomba d'água (esq.) / Bomba de agua (izq.) / Water pump (left)			1.6	62202 2RS / C3		BB

Idea

Eixo Dianteiro / Eje Delantero / Front Axle

Roda / Rueda / Wheel				F 16013		BBDRAC
----------------------	--	--	--	---------	--	--------

Motor / Motor / Engine

Alternador - lado coletor / Alternador - lado colector / Alternator - manifold				6201 2RS / C3		BB
				62201 2RS / C3		BB
Alternador - lado polia / Alternador - lado polea / Alternator - pulley				6203 2RS / C3		BB

Marea * Marea Turbo * Marea Weekend

Diferencial / Diferencial / Differential

Coroa lateral (dir./esq.) / Lateral corona (der./izq.) / Crown gear (right/left)				32009 XF		TRB
--	--	--	--	----------	--	-----

Motor / Motor / Engine

			2.0 20V	6204 C3		BB
--	--	--	---------	---------	--	----

Marea * Marea Weekend

Eixo Dianteiro / Eje Delantero / Front Axle

Roda / Rueda / Wheel			1.8L - 16V * Turbo	F 16013		BBDRAC
----------------------	--	--	--------------------	---------	--	--------

Eixo Traseiro / Eje Trasero / Rear Axle

Roda / Rueda / Wheel				KV 164		KIT
----------------------	--	--	--	--------	--	-----

Oggi

Motor / Motor / Engine

Alternador (dianteiro) / Alternador (delantero) / Alternator (front)			Bosch	6203 2RS / C3		BB
Alternador - lado coletor / Alternador - lado colector / Alternator - manifold				6201 2RS / C3		BB
				62201 2RS / C3		BB
Alternador - lado polia / Alternador - lado polea / Alternator - pulley				6203 2RS / C3		BB
Alternador (traseiro) / Alternador (trasero) / Alternator (rear)			Bosch	6201 2RS / C3		BB
			Bosch 70A	62201 2RS / C3		BB

Palio * Palio Weekend * Siena

Eixo Dianteiro / Eje Delantero / Front Axle

Roda / Rueda / Wheel			1.6 e 1.8L * Weekend Adventure	F 16013		BBDRAC
----------------------	--	--	--------------------------------	---------	--	--------

Eixo Traseiro / Eje Trasero / Rear Axle

Roda / Rueda / Wheel				KV 164		KIT
----------------------	--	--	--	--------	--	-----

	OUT	IN		Fersa®	N° OEM	
---	-----	----	---	---------------	--------	---

FIAT

Panorama

Motor / Motor / Engine

Alternador - lado coletor / Alternador - lado colector / Alternator - manifold				6201 2RS / C3		BB
				62201 2RS / C3		BB
Alternador - lado polia / Alternador - lado polea / Alternator - pulley				6203 2RS / C3		BB

Pick-up

Motor / Motor / Engine

Alternador (dianteiro) / Alternador (delantero) / Alternator (front)			Bosch	6203 2RS / C3		BB
Alternador - lado coletor / Alternador - lado colector / Alternator - manifold				6201 2RS / C3		BB
				62201 2RS / C3		BB
Alternador - lado polia / Alternador - lado polea / Alternator - pulley				6203 2RS / C3		BB
Alternador (traseiro) / Alternador (trasero) / Alternator (rear)			Bosch	6201 2RS / C3		BB
			Bosch 70A	62201 2RS / C3		BB
Bomba d'água (dir.) / Bomba de agua (der.) / Water pump (right)			1.6	62302 2RS / C3		BB
Bomba d'água (esq.) / Bomba de agua (izq.) / Water pump (left)			1.6	62202 2RS / C3		BB

Prêmio

Eixo Dianteiro / Eje Delantero / Front Axle

Roda / Rueda / Wheel				F 16013		BBDRAC
----------------------	--	--	--	----------------	--	--------

Motor / Motor / Engine

Alternador (dianteiro) / Alternador (delantero) / Alternator (front)			Bosch	6203 2RS / C3		BB
Alternador (traseiro) / Alternador (trasero) / Alternator (rear)			Bosch	6201 2RS / C3		BB
			Bosch 70A	62201 2RS / C3		BB
Bomba d'água (dir.) / Bomba de agua (der.) / Water pump (right)			1.6	62302 2RS / C3		BB
Bomba d'água (esq.) / Bomba de agua (izq.) / Water pump (left)			1.6	62202 2RS / C3		BB

Spazio

Motor / Motor / Engine

Alternador (dianteiro) / Alternador (delantero) / Alternator (front)			Bosch	6203 2RS / C3		BB
Alternador - lado coletor / Alternador - lado colector / Alternator - manifold				6201 2RS / C3		BB
				62201 2RS / C3		BB
Alternador - lado polia / Alternador - lado polea / Alternator - pulley				6203 2RS / C3		BB
Alternador (traseiro) / Alternador (trasero) / Alternator (rear)			Bosch	6201 2RS / C3		BB
			Bosch 70A	62201 2RS / C3		BB

Stilo

Eixo Traseiro / Eje Trasero / Rear Axle

Roda / Rueda / Wheel				KV 164		KIT
----------------------	--	--	--	---------------	--	-----

Strada

Eixo Dianteiro / Eje Delantero / Front Axle

Roda / Rueda / Wheel			1.5L - 8V * 1.6L * 8V e 16V	F 16013		BBDRAC
----------------------	--	--	-----------------------------	----------------	--	--------

	OUT	IN		Fersa®	Nº OEM	
---	-----	----	---	---------------	--------	---

FIAT

Tempra

Câmbio / Caja de Cambios / Gearbox

Lateral coroa (dir./esq.) / Lateral corona (der./izq.) / Crown gear (right/left)			2.0L - 16V	32009 XF		TRB
Ponta semi-Eixo / Punta semi eje / Spindle			2.0L - 16V	6306 2RS / C3		BB

Diferencial / Diferencial / Differential

				32009 XF		TRB
--	--	--	--	-----------------	--	-----

Eixo Dianteiro / Eje Delantero / Front Axle

				6306 2RS / C3		BB
Roda / Rueda / Wheel			2.0L - 8V * 16V	F 16013		BBDRAC

Eixo Traseiro / Eje Trasero / Rear Axle

Roda / Rueda / Wheel				KV 164		KIT
----------------------	--	--	--	---------------	--	-----

Motor / Motor / Engine

Alternador (dianteiro) / Alternador (delantero) / Alternator (front)			Bosch	6303 2RS / C3		BB
Alternador - lado polia / Alternador - lado polea / Alternator - pulley				62201 2RS / C3		BB
				6303 2RS / C3		BB
Alternador (traseiro) / Alternador (trasero) / Alternator (rear)			Bosch	62201 2RS / C3		BB

Tipo

Câmbio e diferencial / Caja de Cambios y Diferencial / Gearbox and differential

Coroa lateral (dir./esq.) / Lateral corona (der./izq.) / Crown gear (right/left)			2.0 SLXe 16V	32009 XF		TRB
--	--	--	--------------	-----------------	--	-----

Eixo Dianteiro / Eje Delantero / Front Axle

Roda / Rueda / Wheel			1.6L	F 16026		BBDRAC
			2.0L	F 16013		BBDRAC

Eixo Traseiro / Eje Trasero / Rear Axle

Roda / Rueda / Wheel				KV 164		KIT
----------------------	--	--	--	---------------	--	-----

Motor / Motor / Engine

			2.0 SLX * 16V	6204 C3		BB
			2.0 SLX * 16V	6005 2RS / C3		BB

Uno

Eixo Dianteiro / Eje Delantero / Front Axle

Roda / Rueda / Wheel			94...96 * Uno Turbo	F 16013		BBDRAC
----------------------	--	--	---------------------	----------------	--	--------

Motor / Motor / Engine

Alternador (dianteiro) / Alternador (delantero) / Alternator (front)			Bosch	6203 2RS / C3		BB
Alternador - lado coletor / Alternador - lado colector / Alternator - manifold				6201 2RS / C3		BB
				62201 2RS / C3		BB
Alternador - lado polia / Alternador - lado polea / Alternator - pulley				6203 2RS / C3		BB
Alternador (traseiro) / Alternador (trasero) / Alternator (rear)			Bosch	6201 2RS / C3		BB
			Bosch 70A	62201 2RS / C3		BB
Bomba d'água (dir.) / Bomba de agua (der.) / Water pump (right)			1.6	62302 2RS / C3		BB
Bomba d'água (esq.) / Bomba de agua (izq.) / Water pump (left)			1.6	62202 2RS / C3		BB



	OUT	IN		Fersa [®]	N° OEM	
---	-----	----	---	---------------------------	--------	---

FORD

Belina * Belina II * Corcel * Corcel II

				32304 F	BD1M7A453A	TRB
--	--	--	--	----------------	------------	-----

Câmbio / Caja de Cambios / Gearbox

Lateral coroa (esq.) / Lateral corona (izq.) / Crown gear (left)				30207 F	8575681	TRB
--	--	--	--	----------------	---------	-----

Eixo Dianteiro / Eje Delantero / Front Axle

Roda / Rueda / Wheel		•		LM 78349 / LM 78310 A		TRB
	•			LM 78349 / LM 78310 A		TRB

Eixo Traseiro / Eje Trasero / Rear Axle

Roda / Rueda / Wheel		•		L 44649 / L 44610	527994/527995	TRB
	•			30304 F	49979	TRB
	•			LM 11949 / LM 11910	B5A1216A/ B5A1217A	TRB

Motor / Motor / Engine

Alternador (dianteiro) / Alternador (delantero) / Alternator (front)			Wapsa	6203 2RS / C3	80227	BB
Alternador (traseiro) / Alternador (trasero) / Alternator (rear)				6200 2RS / C3	80235	BB
Bomba d'água (dianteiro) / Bomba de agua (delantero) / Water pump (front)				6202 ZZ / C3	46558	BB
Bomba d'água (traseiro) / Bomba de agua (trasero) / Water pump rear				6202 2RS / C3	46557	BB

Belina I (...78) * Corcel I (...78)

Diferencial / Diferencial / Differential

Coroa lat. (dir.) / Corona lateral (der.) / Crown gear (right)				30207 F		TRB
Pinhão cônico (traseiro) / Piñón cónico (trasero) / Bevel gear (rear)				6001		BB

Motor / Motor / Engine

Alternador (dianteiro) / Alternador (delantero) / Alternator (front)			Wapsa	6203 2RS / C3		BB
Alternador (traseiro) / Alternador (trasero) / Alternator rear			...73	6200 2RS / C3		BB
Bomba d'água (dianteiro) / Bomba de agua (delantero) / Water pump (front)				30203 F		TRB
Bomba d'água (traseiro) / Bomba de agua (trasero) / Water pump (rear)				32304 F		TRB

Belina II (79...) * Corcel II (79...)

Caixa de transferência / Caja de Transferencia / Transfer Case

Eixo de saída / Eje de salida / Output shaft				6206 C3		BB
--	--	--	--	----------------	--	----

Câmbio / Caja de Cambios / Gearbox

				32304 F		TRB
Eixo primário (dianteiro) / Eje primario (delantero) / Primary shaft (front)				30203 F		TRB

Diferencial / Diferencial / Differential

Coroa lat (esq.) / Corona lateral (izdo.) / Crown gear (left)				30207 F		TRB
---	--	--	--	----------------	--	-----

Direção / Dirección / Steering

Pinhão cônico (traseiro) / Piñón cónico (trasero) / Bevel gear (rear)				6001		BB
---	--	--	--	-------------	--	----

Motor / Motor / Engine

Alternador (dianteiro) / Alternador (delantero) / Alternator (front)			Wapsa	6203 2RS / C3		BB
--	--	--	-------	----------------------	--	----

Contour

Eixo Dianteiro / Eje Delantero / Front Axle

Roda / Rueda / Wheel			2.0L * 96...00	F 16055		BBDRAC
			2.5L * 96...00	F 16055		BBDRAC

	OUT	IN		Fersa [®]	N° OEM	
---	-----	----	---	---------------------------	--------	---

FORD

Cougar

Eixo Dianteiro / Eje Delantero / Front Axle

Roda / Rueda / Wheel	•		3.8L * 85...88	L 68149 / L 68111		TRB
		•	3.8L * 85...88	LM 12749 / LM 12710		TRB

Eixo Traseiro / Eje Trasero / Rear Axle

Roda / Rueda / Wheel			89...90	F 16194		BBDRAC
			3.8L * 90...94	F 16194		BBDRAC
			4.6L * 1995	F 16194		BBDRAC
			4.9L * 91...94	F 16194		BBDRAC

Courier

Câmbio e diferencial / Caja de Cambios y Diferencial / Gearbox and differential

Coroa lateral (esq.) / Lateral corona (izdo.) / Crown gear (left)			IB5	LM 11749 / LM 11710		TRB
---	--	--	-----	---------------------	--	-----

Eixo Dianteiro / Eje Delantero / Front Axle

Roda / Rueda / Wheel			1.6L * 01...	F 16036		BBDRAC
----------------------	--	--	--------------	---------	--	--------

Eixo Traseiro / Eje Trasero / Rear Axle

Roda / Rueda / Wheel			1.6L * 01...	F 15029		TRBS
----------------------	--	--	--------------	---------	--	------

Motor / Motor / Engine

Alternador (dianteiro) / Alternador (delantero) / Alternator (front)			1.0 * 1.3 75A * 90A com/con/with AC	6303 2RS / C3		BB
Alternador (traseiro) / Alternador (trasero) / Alternator (rear)			1.0 * 1.3 75A sim/sin/without AC	6003 2RS / C3		BB
			1.0 * 1.3 75A * 90A com/con/with AC	6203 2RS / C3		BB

Del Rey * Pampa

Caixa de transferência / Caja de Transferencia / Transfer Case

Eixo de saída / Eje de salida / Output shaft				6206 C3		BB
--	--	--	--	---------	--	----

Câmbio / Caja de Cambios / Gearbox

				32304 F	BD1M7A453A	TRB
Lateral coroa (esq.) / Lateral corona (izq.) / Crown gear (left)				30207 F		TRB
Eixo primário (dianteiro) / Eje primario (delantero) / Primary shaft (front)				30203 F		TRB
Eixo primário (traseiro) / Eje primario (trasero) / Primary shaft (rear)				32304 F		TRB

Diferencial / Diferencial / Differential

Coroa lateral (dir. / esq.) / Lateral corona (der. / izq.) / Crown gear (right/left)			Pampa AP 1.8	LM 300849 / LM 300811		TRB
Coroa lat. (esq.) / Corona Lateral (izdo.) / Crown Gear (left)				30207 F		TRB

Direção / Dirección / Steering



Pinhão cônico (traseiro) / Piñón cónico (trasero) / Bevel gear (rear)				6001		BB
---	--	--	--	------	--	----

Eixo Dianteiro / Eje Delantero / Front Axle

Roda / Rueda / Wheel		•		LM 78349 / LM 78310 A		TRB
	•			LM 78349 / LM 78310 A		TRB

Eixo Traseiro / Eje Trasero / Rear Axle

Roda / Rueda / Wheel		•		L 44649 / L 44610	527994/527995	TRB
	•			30304 F	49979	TRB
	•			LM 11949 / LM 11910	B5A1216A / B5A1217A	TRB

	OUT	IN		Fersa [®]	N° OEM	
---	-----	----	---	---------------------------	--------	---

FORD

Del Rey * Pampa

Motor / Motor / Engine

Alternador (dianteiro) / Alternador (delantero) / Alternator (front)			Wapsa	6203 2RS / C3		BB
Alternador (traseiro) / Alternador (trasero) / Alternator (rear)				6200 2RS / C3	80235	BB
Bomba d'água (dianteiro) / Bomba de agua (delantero) / Water pump (front)				6202 ZZ / C3	46558	BB
Bomba d'água (traseiro) / Bomba de agua (trasero) / Water pump (rear)				6202 2RS / C3		BB

Escape

Eixo Traseiro / Eje Trasero / Rear Axle

Roda / Rueda / Wheel			2.3L * 2008	F 16055		BBDRAC
			2.5L * 09...	F 16055		BBDRAC
			3.0L * 01...	F 16055		BBDRAC

Escort

Câmbio / Caja de Cambios / Gearbox

Eixo piloto (dianteiro) / Eje piloto (delantero) / Pilot shaft (front)			1.0 * 1.8L * 83...94	F 18024	81TT7025BA	BBS
			1.6 * 1.8L * 93...96	LM 29749 / LM 29710	003519185	TRB
Eixo secundário (lado volante) / Eje secundario (lado volante) / Secondary shaft (steering wheel)			1.6 * 1.8L * 93...96	L 45449 / L 45410	311405625C	TRB
Lateral coroa (esq.) / Lateral corona (izq) / Crown gear (left)			1.6 * 1.8L * 93...97	LM 300849 / LM 300811	113517185B	TRB

Eixo Dianteiro / Eje Delantero / Front Axle

Roda / Rueda / Wheel	•	•	1.6 * 1.8L	F 15036	81AB1215AB	TRBS
			KIT	KA 019	81AB1215AB	KIT

Eixo Traseiro / Eje Trasero / Rear Axle

Roda / Rueda / Wheel			KIT	KA 021	096FXIA049AB	KIT
			KIT	KA 075	72GB1200AA / 11527972	KIT
		•		L 45449 / L 45410	72GB1200AA	TRB
	•			LM 11749 / LM 11710	11527972	TRB

Motor / Motor / Engine

Alternador - lado coletor / Alternador - lado colector / Alternator - manifold			Opc. 6201 2ZZ / C3	6201 2RS / C3		BB
			1.6 * 1.8 * 2.0L * Opc. 6201 2ZZ / C3	6201 2RS / C3		BB
Alternador - lado polia / Alternador - polea / Alternator - pulley				6203 2RS / C3	7RA10094A	BB
			1.6 * 1.8 * 2.0L	6303 2RS / C3	80227	BB

Escort Hobby

Eixo Dianteiro / Eje Delantero / Front Axle

Roda / Rueda / Wheel	•	•	1.0L	F 15036	81AB1215AB	TRBS
				KA 019	81AB1215AB	KIT



Eixo Traseiro / Eje Trasero / Rear Axle



Roda / Rueda / Wheel		•	1.0L	L 45449 / L 45410	72GB1200AA	TRB
	•		1.0L	LM 11749 / LM 11710	11527972	TRB

Excursion

Eixo Traseiro / Eje Trasero / Rear Axle

Roda / Rueda / Wheel	•		6.8L * 01...05	387 A / 382 A		TRB
----------------------	---	--	----------------	----------------------	--	-----

	OUT	IN		Fersa®	N° OEM	
FORD						
Excursion						
Roda / Rueda / Wheel		•	6.8L * 01...05	LM 104949 / LM 104911		TRB
Expedition						
Eixo Dianteiro / Eje Delantero / Front Axle						
Roda / Rueda / Wheel	•		4.6L * 97...01	JL 69349 / JL 69310		TRB
		•	4.6L * 97...01	LM 12749 / LM 12710		TRB
	•		5.4L * 97...01	JL 69349 / JL 69310		TRB
		•	5.4L * 97...01	LM 12749 / LM 12710		TRB
Explorer						
Diferencial / Diferencial / Differential						
			4X4	LM 501349 / LM 501314		TRB
			4X4	HM 88649 / HM 88620		TRB
			4X4	M 88048 / M 88010		TRB
			4X4	M 802048 / M 802011		TRB
Eixo Dianteiro / Eje Delantero / Front Axle						
Roda / Rueda / Wheel		•	4 x 4	LM 603049 / LM 603011	B7A4221B/ B7A4222B	TRB
	•		4 x 4	LM 603049 / LM 603011	B7A4221B/ B7A4222B	TRB
		•	4.0L * 91...94	LM 11949 / LM 11910		TRB
	•		4.0L * 91...94	LM 67048 / LM 67010		TRB
F 100						
Eixo Dianteiro / Eje Delantero / Front Axle						
Roda / Rueda / Wheel		•		LM 48548 / LM 48510	B7C1200A	TRB
	•			LM 11949 / LM 11910	B5A1216A/ B5A1217A	TRB
Motor / Motor / Engine						
Alternador (dianteiro) / Alternador (delantero) / Alternator (front)				6203 2RS / C3	7RA10094A	BB
Polia tensora / Polea tensora / Tensioner pulley				6204	WD8T9K913B	BB
F 1000 (79...)						
Câmbio / Caja de Cambios / Gearbox						
Eixo intermediário (traseiro) / Eje intermediario (trasero) / Intermediate shaft (rear)			89...	6308 NR		BB
Eixo secund. / Eje secundario / Secondary shaft			89...	6308 NR		BB
Diferencial / Diferencial / Differential						
Coroa lat. (dir./esq.) / Lateral corona (der./izq.) / Crown gear (right / left)			...89	25577 / 25523		TRB
Pinhão cônico (traseiro) / Piñón cónico (trasero) / Bevel gear rear			...89	31594 / 31520		TRB
			93...	HM 88649 / HM 88610		TRB
Coroa lat (dir./esq.) / Lateral corona (der./izq.) / Crown gear (right/left)			84...86	368 A / 362 X		TRB

	OUT	IN		Fersa [®]	N° OEM	
---	-----	----	---	---------------------------	--------	---

FORD

F 1000 (79...)

Pinhão cônico (dianteiro) / Piñón cónico (delantero) / Bevel gear (front)			84...86	M 88048 / M 88010		TRB
Pinhão cônico (traseiro) / Piñón cónico (trasero) / Bevel gear (rear)			84...86	M 802048 / M 802011		TRB

Eixo Dianteiro / Eje Delantero / Front Axle

Roda / Rueda / Wheel		•		LM 48548 / LM 48510	B7C1200A	TRB
		•	4 x 2 * 4 x 4	LM 603049 / LM 603011	B7A4221B/ B7A4222B	TRB
		•		LM 11949 / LM 11910	B5A1216A/ B5A1217A	TRB
		•	4 x 2 * 4 x 4	LM 501349 / LM 501314	B7A4221A/ B7A4222A	TRB
		•		M 12649 / M 12610	C1W1215A ou C3SZ1216+1217A	TRB

Motor / Motor / Engine

Alternador (dianteiro) / Alternador (delantero) / Alternator (front)				6203 2RS / C3	7RA10094A	BB
Polia tensora / Polea tensora / Tensioner pulley				6204	WD8T9K913B	BB

F 2000

Eixo Dianteiro / Eje Delantero / Front Axle

Roda / Rueda / Wheel		•		LM 603049 / LM 603011	B7A4221B/ B7A4222B	TRB
		•		LM 501349 / LM 501310	B7A4221A/ B7A4222A	TRB

Motor / Motor / Engine

Alternador (dianteiro) / Alternador (delantero) / Alternator (front)				6203 2RS / C3	7RA10094A	BB
Polia tensora / Polea tensora / Tensioner pulley				6204	WD8T9K913B	BB

F 2000 (80...)

Câmbio / Caja de Cambios / Gearbox

Eixo secund. / Eje secundario / Secondary shaft			...82	6308 NR		BB
Eixo intermediário (traseiro) / Eje Intermediario (trasero) / Intermediate shaft (rear)			82...	6308 NR		BB
Eixo secund. / Eje secundario / Secondary shaft			82...	6308 NR		BB

Diferencial / Diferencial / Differential

Coroa lat. (dir./esq.) / Lateral corona (der./izq.) / Crown gear (right/left)				387 A / 382 A		TRB
Pinhão cônico (dianteiro) / Piñón cónico (delantero) / Bevel gear (front)				HM 88542 / HM 88510		TRB
Pinhão cônico (traseiro) / Piñón cónico (trasero) / Bevel gear (rear)				HM 803146 / HM 803110		TRB

Motor / Motor / Engine

Alternador (dianteiro) / Alternador (delantero) / Alternator (front)				6203 2RS / C3		BB
--	--	--	--	----------------------	--	----

F 350

Câmbio / Caja de Cambios / Gearbox

Eixo secund. / Eje secundario / Secondary shaft			...77	6308 NR		BB
---	--	--	-------	----------------	--	----

Diferencial / Diferencial / Differential

Coroa lat (dir.) / Corona Lateral (der.) / Crown Gear (right)			59...77	387 A / 382 A		TRB
Pinhão cônico (traseiro) / Piñón cónico (trasero) / Bevel gear (rear)			59...77	HM 807046 / HM 807010		TRB

	OUT	IN		Fersa®	N° OEM	
FORD						
F 350						
Eixo Dianteiro / Eje Delantero / Front Axle						
Roda / Rueda / Wheel		•		LM 501349 / LM 501310	B7A4221A/ B7A4222A	TRB
Motor / Motor / Engine						
Alternador (dianteiro) / Alternador (delantero) / Alternator (front)			Opc. 6203 ZZ / C3	6203 2RS / C3	7RA10094A	BB
Polia tensora / Polea tensora / Tensioner pulley				6204	WD8T9K913B	BB
F 400						
Câmbio / Caja de Cambios / Gearbox						
Eixo secund. / Eje secundario / Secondary shaft				6308 NR		BB
Diferencial / Diferencial / Differential						
Coroa lat (dir./esq.) / Lateral corona (der./izq.) / Crown gear (right/left)				387 A / 382 A		TRB
Pinhão cônico (traseiro) / Piñón cónico (trasero) / Bevel gear (rear)				HM 807046 / HM 807010		TRB
Eixo Dianteiro / Eje Delantero / Front Axle						
Roda / Rueda / Wheel		•	75...77	LM 501349 / LM 501310	B7A4221A/ B7A4222A	TRB
Motor / Motor / Engine						
Alternador (dianteiro) / Alternador (delantero) / Alternator (front)			Opc. 6203 ZZ / C3	6203 2RS / C3	7RA10094A	BB
Polia tensora / Polea tensora / Tensioner pulley				6204	WD8T9K913B	BB
F 4000						
Eixo Dianteiro / Eje Delantero / Front Axle						
Roda / Rueda / Wheel		•		LM 603049 / LM 603011	B7A4221B/ B7A4222B	TRB
		•		LM 501349 / LM 501310	B7A4221A/ B7A4222A	TRB
Eixo Traseiro / Eje Trasero / Rear Axle						
Roda / Rueda / Wheel	•			3982 / 3920	B6T1243A/1244A	TRB
Motor / Motor / Engine						
Alternador (dianteiro) / Alternador (delantero) / Alternator (front)				6203 2RS / C3	7RA10094A	BB
Polia tensora / Polea tensora / Tensioner pulley				6204	WD8T9K913B	BB
F 4000 (75...)						
Câmbio / Caja de Cambios / Gearbox						
Eixo secund. / Eje secundario / Secondary shaft			...82	6308 NR		BB
Eixo intermediário (traseiro) / Eje Intermediario (trasero) / Intermediate shaft (rear)			82...	6308 NR		BB
Eixo secund. / Eje secundario / Secondary shaft			82...	6308 NR		BB
Diferencial / Diferencial / Differential						
Coroa lat. (dir./esq.) / Lateral corona (der./izq.) / Crown gear (right/left)				387 A / 382 A		TRB
Pinhão cônico (dianteiro) / Piñón cónico (delantero) / Bevel gear (front)				HM 88542 / HM 88510		TRB
Pinhão cônico (traseiro) / Piñón cónico (trasero) / Bevel gear (rear)				HM 803146 / HM 803110		TRB
Motor / Motor / Engine						
Alternador (dianteiro) / Alternador (delantero) / Alternator (front)				6203 2RS / C3		BB
			4X4	14131 / 14276		TRB

	OUT	IN		Fersa®	Nº OEM	
---	-----	----	---	---------------	--------	---

FORD

F 4000 (75...)

Câmbio / Caja de Cambios / Gearbox

Eixo secund. (traseiro) / Eje secundario (trasero) / Secondary shaft (rear)				6206 C3		BB
---	--	--	--	----------------	--	----

Diferencial / Diferencial / Differential

Coroa lateral (dir./esq.) / Lateral corona (der./izq.) / Crown gear (right/left)				25577 / 25523		TRB
--	--	--	--	----------------------	--	-----

Pinhão cônico (traseiro) / Piñón cónico (trasero) / Bevel gear (rear)				31594 / 31520		TRB
---	--	--	--	----------------------	--	-----

Eixo Dianteiro / Eje Delantero / Front Axle

Roda / Rueda / Wheel			4 x 4	11590 / 11520	16176	TRB
----------------------	--	--	-------	----------------------	-------	-----

Motor / Motor / Engine

Alternador (dianteiro) / Alternador (delantero) / Alternator (front)			Wapsa 4 x 4 & Bosch 4 x 4	6203 2RS / C3	80227 e 84989	BB
--	--	--	---------------------------	----------------------	---------------	----

			Wapsa	6203 2RS / C3		BB
--	--	--	-------	----------------------	--	----

			Opc. 6203 ZZ / C3 (Bosch)	6203 2RS / C3		BB
--	--	--	---------------------------	----------------------	--	----

Alternador (traseiro) / Alternador (trasero) / Alternator (rear)			Wapsa * 4 x 4 e	6200 2RS / C3	80235	BB
--	--	--	-----------------	----------------------	-------	----

			Bosch * 4 x 4	6201 2RS / C3	84990	BB
--	--	--	---------------	----------------------	-------	----

			73... Wapsa	6200 2RS / C3		BB
--	--	--	-------------	----------------------	--	----

			Opc. 6203 ZZ / C3 (Bosch)	6201 2RS / C3		BB
--	--	--	---------------------------	----------------------	--	----

Dínamo (dianteiro) / Dinamo (delantero) / Dynamo (front)			4x4	6203 ZZ	84989	BB
--	--	--	-----	----------------	-------	----

Dínamo (dianteiro/traseiro) / Dinamo (delantero/trasero) / Dynamo (front/rear)			4x4	6202	80339	BB
--	--	--	-----	-------------	-------	----

F 150 (Mx)

Eixo Dianteiro / Eje Delantero / Front Axle

Roda / Rueda / Wheel	●		3.8L * 80...94	L 68149 / L 68110		TRB
----------------------	---	--	----------------	--------------------------	--	-----

	●		3.8L * 80...94	LM 12749 / LM 12710		TRB
--	---	--	----------------	----------------------------	--	-----

	●		4.2L * 98...04	JL 69349 / JL 69310		TRB
--	---	--	----------------	----------------------------	--	-----

	●		4.2L * 98...04	LM 12749 / LM 12710		TRB
--	---	--	----------------	----------------------------	--	-----

	●		4.9L * 95...96	L 68149 / L 68110		TRB
--	---	--	----------------	--------------------------	--	-----

	●		4.9L * 95...96	LM 12749 / LM 12710		TRB
--	---	--	----------------	----------------------------	--	-----

F 250 (Mx)

Eixo Dianteiro / Eje Delantero / Front Axle

Roda / Rueda / Wheel	●		4.6L * 97...99	LM 102949 / LM 102910		TRB
----------------------	---	--	----------------	------------------------------	--	-----

	●		4.6L * 97...99	15101 / 15245		TRB
--	---	--	----------------	----------------------	--	-----

	●		5.0L * 92...97	LM 102949 / LM 102910		TRB
--	---	--	----------------	------------------------------	--	-----

	●		5.0L * 92...97	15101 / 15245		TRB
--	---	--	----------------	----------------------	--	-----

	●		5.8L * 92...96	LM 102949 / LM 102910		TRB
--	---	--	----------------	------------------------------	--	-----

	●		5.8L * 92...96	15101 / 15245		TRB
--	---	--	----------------	----------------------	--	-----

Eixo Traseiro / Eje Trasero / Rear Axle

Roda / Rueda / Wheel	●		97...99	387 A / 382 A		TRB
----------------------	---	--	---------	----------------------	--	-----

	●		97...99	LM 104949 / LM 104911		TRB
--	---	--	---------	------------------------------	--	-----

	●		4.6L * 97...99	387 A / 382 A		TRB
--	---	--	----------------	----------------------	--	-----

	●		4.6L * 97...99	LM 104949 / LM 104911		TRB
--	---	--	----------------	------------------------------	--	-----

	OUT	IN		Fersa [®]	N° OEM	
---	-----	----	---	---------------------------	--------	---

FORD

F 250 (Mx)

Roda / Rueda / Wheel	•			387 A / 382 A		TRB
		•		LM 104949 / LM 104911		TRB
	•		4.6L * 05...	387 A / 382 A		TRB
		•	4.6L * 05...	LM 104949 / LM 104911		TRB
	•		4.6L * 98...04	387 A / 382 A		TRB
		•	4.6L * 98...04	LM 104949 / LM 104911		TRB
	•		4.6L * 05...09	387 A / 382 A		TRB
		•	4.6L * 05...09	LM 104949 / LM 104911		TRB
	•		5.0L * 92...97	387 A / 382 A		TRB
		•	5.0L * 92...97	LM 104949 / LM 104911		TRB
	•		5.4L * 00...03	387 A / 382 A		TRB
		•	5.4L * 00...03	LM 104949 / LM 104911		TRB
	•		5.4L * 04...	387 A / 382 A		TRB
		•	5.4L * 04...	LM 104949 / LM 104911		TRB
	•		5.4L * 99...04	387 A / 382 A		TRB
		•	5.4L * 99...04	LM 104949 / LM 104911		TRB
	•		5.4L * 05...	387 A / 382 A		TRB
		•	5.4L * 05...	LM 104949 / LM 104911		TRB
	•		5.8L * 92...96	387 A / 382 A		TRB
		•	5.8L * 92...96	LM 104949 / LM 104911		TRB
	•		6.4L * 09...	387 A / 382 A		TRB
		•	6.4L * 09...	LM 104949 / LM 104911		TRB

F 350 (Mx)

Eixo Dianteiro / Eje Delantero / Front Axle

Roda / Rueda / Wheel	•		5.0L * 86...97	LM 102949 / LM 102910		TRB
		•	5.0L * 86...97	15101 / 15245		TRB
	•		5.8L * 95...97	LM 102949 / LM 102910		TRB
		•	5.8L * 95...97	15101 / 15245		TRB

Eixo Traseiro / Eje Trasero / Rear Axle

Roda / Rueda / Wheel	•		5.0L * 86...97	387 A / 382 A		TRB
		•	5.0L * 86...97	LM 104949 / LM 104911		TRB
	•		5.4L * 99...04	387 A / 382 A		TRB
		•	5.4L * 99...04	LM 104949 / LM 104911		TRB
	•		5.4L * 05...	387 A / 382 A		TRB
		•	5.4L * 05...	LM 104949 / LM 104911		TRB
	•		5.8L * 95...97	387 A / 382 A		TRB
		•	5.8L * 95...97	LM 104949 / LM 104911		TRB

	OUT	IN		Fersa [®]	N° OEM	
---	-----	----	---	---------------------------	--------	---

FORD

F 450 (Mx)

Eixo Traseiro / Eje Trasero / Rear Axle

Roda / Rueda / Wheel	•		6.0L * 05...07	387 A / 382 A		TRB
		•	6.0L * 05...07	LM 104949 / LM 104911		TRB
	•		6.4L * 08...	387 A / 382 A		TRB
		•	6.4L * 08...	LM 104949 / LM 104911		TRB
	•		6.8L * 00...02	387 A / 382 A		TRB
		•	6.8L * 00...02	LM 104949 / LM 104911		TRB
	•		6.8L * 03...04	387 A / 382 A		TRB
		•	6.8L * 03...04	LM 104949 / LM 104911		TRB
	•		6.8L * 05...	387 A / 382 A		TRB
		•	6.8L * 05...	LM 104949 / LM 104911		TRB
	•		7.3L * 00...03	387 A / 382 A		TRB
		•	7.3L * 00...03	LM 104949 / LM 104911		TRB

Fiesta

Câmbio / Caja de Cambios / Gearbox

Eixo piloto (dianteiro) / Eje piloto (delantero) / Pilot shaft (front)			1.0 * 1.8L * 94...95	F 18024	81TT7025BA	BBS
Câmbio e Diferencial / Caja de Cambios y Diferencial / Gearbox and Differential						
Coroa lateral (esq.) / Lateral corona (izq.) / Crown gear (left)			IB5	LM 11749 / LM 11710		TRB

Eixo Dianteiro / Eje Delantero / Front Axle

Roda / Rueda / Wheel			1.3L * 98...01	F 16036		BBDRAC
			1.4L * 98...00	F 16036		BBDRAC
			1.6L * 01...05	F 16036		BBDRAC
			1.6L * 06...10	F 16036		BBDRAC

Eixo (traseiro) / Eje (trasero) / (rear) Axle

Roda / Rueda / Wheel				KA 021		KIT
		•	1.3L * 98...01	F 15029		TRBS
		•	1.4L * 98...00	F 15029		TRBS
		•	1.6L * 01...05	F 15029		TRBS

Motor / Motor / Engine

Alternador (dianteiro) / Alternador (delantero) / Alternator (front)			1.0e * 1.3 75A * 90A, com/con/with AC	6303 2RS / C3		BB
Alternador (traseiro) / Alternador (trasero) / Alternator (rear)			1.0e * 1.3 75A, sim/sin/without AC	6003 2RS / C3		BB
			1.0e * 1.3 75A * 90A, com/con/with AC	6203 2RS / C3		BB

Focus

Eixo Dianteiro / Eje Delantero / Front Axle



Roda / Rueda / Wheel			2.0L * 00...07	F 16036		BBDRAC
----------------------	--	--	----------------	---------	--	--------

Fusion

Eixo Dianteiro / Eje Delantero / Front Axle

Roda / Rueda / Wheel			2.3L * 07...09	F 16088		BBDRAC
			2.5L * 10...	F 16088		BBDRAC
			3.0L * 07...	F 16088		BBDRAC
			3.5L * 10...	F 16088		BBDRAC

	OUT	IN		Fersa®	Nº OEM	
FORD						
Galaxie 500						
Eixo Dianteiro / Eje Delantero / Front Axle						
Roda / Rueda / Wheel		•		LM 48548 / LM 48510	B7C1200A	TRB
	•			LM 11949 / LM 11910	B5A1216A / B5A1217A	TRB
Ghia						
Eixo Traseiro / Eje Trasero / Rear Axle						
Roda / Rueda / Wheel	•		2.3L * 1991	L 45449 / L 45410		TRB
		•	2.3L * 1991	LM 12749 / LM 12710		TRB
	•		3.0L * 91...94	L 45449 / L 45410		TRB
		•	3.0L * 91...94	LM 12749 / LM 12710		TRB
Grand Marquis						
Eixo Dianteiro / Eje Delantero / Front Axle						
Roda / Rueda / Wheel	•		5.0L * 82...84	JL 69349 / JL 69310		TRB
		•	5.0L * 82...84	LM 12749 / LM 12710		TRB
	•		5.0L * 82...84	JL 69349 / JL 69310		TRB
		•	5.0L * 82...84	LM 12749 / LM 12710		TRB
Ikon						
Eixo Dianteiro / Eje Delantero / Front Axle						
Roda / Rueda / Wheel			1.6L * 04...07	F 16036		BBDRAC
Eixo Traseiro / Eje Trasero / Rear Axle						
Roda / Rueda / Wheel		•	1.6L * 04...07	F 15029		TRBS
Jeep						
Eixo Dianteiro / Eje Delantero / Front Axle						
Roda / Rueda / Wheel			4 x 4	11590 / 11520	16176	TRB
Motor / Motor / Engine						
Alternador (dianteiro) / Alternador (delantero) / Alternator (front)			Wapsa - 4 x 4	6203 2RS / C3	80227	BB
			Wapsa - 4 x 4	6203 2RS / C3	84989	BB
Alternador (traseiro) / Alternador (trasero) / Alternator (rear)			Wapsa - 4 x 4	6200 2RS / C3	80235	BB
			Wapsa - 4 x 4	6201 2RS / C3	84990	BB
Dinamo (dianteiro) / Dinamo (delantero) / Dynamo (front)			4 x 4	6202 C3	80339	BB
			4 x 4	6203 2RS / C3	84989	BB
Dinamo (traseiro) / Dinamo (trasero) / Dynamo (rear)			4 x 4	6202 C3	80339	BB
Jeep Willys (4X2 * 4X4) (60...83)						
Caixa de transferência / Caja de Transferencia / Transfer Case						
			4X4	14131 / 14276		TRB
Câmbio / Caja de Cambios / Gearbox						
Eixo secund (traseiro) / Eje secundario (trasero) / Secondary shaft (rear)				6206 C3		BB
Diferencial / Diferencial / Differential						
Coroa lateral (dir./esq.) / Lateral corona (der./izq.) / Crown gear (right/left)				25577 / 25523		TRB
Pinhão cônico (traseiro) / Piñón cónico (trasero) / Bevel gear (rear)				31594 / 31520		TRB

	OUT	IN		Fersa [®]	N° OEM	
---	-----	----	---	---------------------------	--------	---

FORD

Jeep Willys 4X2 * 4X4 (60...83)

Motor / Motor / Engine

Alternador (dianteiro) / Alternador (delantero) / Alternator (front)			Wapsa	6203 2RS / C3		BB
			Opcional 6203 ZZ / C3 (Bosch)	6203 2RS / C3		BB
Alternador (traseiro) / Alternador (trasero) / Alternator (rear)			73... Wapsa	6200 2RS / C3		BB
			Opcional 6203 ZZ / C3 (Bosch)	6201 2RS / C3		BB
Dínamo (dianteiro) / Dinamo (delantero) / Dynamo (front)			60...65	6203 2RS / C3		BB
			64...65	6202		BB

Ka

Câmbio e Diferencial / Caja de Cambios y Diferencial / Gearbox and Differential

Coroa lateral (esq.) / Lateral corona (izq.) / Crown gear (left)			IB5	LM 11749 / LM 11710		TRB
--	--	--	-----	---------------------	--	-----

Eixo Dianteiro / Eje Delantero / Front Axle

Roda / Rueda / Wheel			1.6L * 01...08	F 16036		BBDRAC
----------------------	--	--	----------------	---------	--	--------

Eixo Traseiro / Eje Trasero / Rear Axle

Roda / Rueda / Wheel				KA 021	096FXIA049AB	KIT
----------------------	--	--	--	--------	--------------	-----

Motor / Motor / Engine

Alternador (dianteiro) / Alternador (delantero) / Alternator (front)			1.0e * 1.3 75A * 90A com/con/with AC	6303 2RS / C3		BB
Alternador (traseiro) / Alternador (trasero) / Alternator (rear)			1.0e * 1.3 75A sim/sin/without AC	6003 2RS / C3		BB
			1.0e * 1.3 75A * 90A com/con/with AC	6203 2RS / C3		BB

Landau

Eixo Dianteiro / Eje Delantero / Front Axle

Roda / Rueda / Wheel		•		LM 48548 / LM 48510	B7C1200A	TRB
	•			LM 11949 / LM 11910	B5A1216A / B5A1217A	TRB

Limited

Eixo Dianteiro / Eje Delantero / Front Axle

Roda / Rueda / Wheel		•		LM 48548 / LM 48510	B7C1200A	TRB
	•			LM 11949 / LM 11910	B5A1216A / B5A1217A	TRB

Microbus

Eixo Dianteiro / Eje Delantero / Front Axle

Roda / Rueda / Wheel	•		5.0L * 86...94	LM 102949 / LM 102910		TRB
		•	5.0L * 86...94	15101 / 15245		TRB
	•		5.8L * 86...94	LM 102949 / LM 102910		TRB
		•	5.8L * 86...94	15101 / 15245		TRB

Eixo Traseiro / Eje Trasero / Rear Axle

Roda / Rueda / Wheel		•	1.6L * 01...08	F 15029		TRBS
	•		5.0L * 86...94	387 A / 382 A		TRB
		•	5.0L * 86...94	LM 104949 / LM 104911		TRB

	OUT	IN		Fersa [®]	Nº OEM	
---	-----	----	---	---------------------------	--------	---

FORD

Mustang

Eixo Dianteiro / Eje Delantero / Front Axle

Roda / Rueda / Wheel	•		5.0L * 80...84	L 68149 / L 68111		TRB
		•	5.0L * 80...84	LM 12749 / LM 12710		TRB

Eixo Traseiro / Eje Trasero / Rear Axle

Roda / Rueda / Wheel	•		5.8L * 86...94	387 A / 382 A		TRB
		•	5.8L * 86...94	LM 104949 / LM 104911		TRB

Ranger

Diferencial / Diferencial / Differential

Coroa lateral (dir./esq.) / Lateral corona (der./izq.) / Crown gear (right/left)				LM 603049 / LM 603012		TRB
			4X4	M 88048 / M 88010		TRB
Pinhão cônico (dianteiro) / Piñón cónico (delantero) / Bevel gear (front)			4X2	HM 88649 / HM 88610		TRB
Pinhão cônico (traseiro) / Piñón cónico (trasero) / Bevel gear (rear)			4X2	M 802048 / M 802011		TRB

Eixo Dianteiro / Eje Delantero / Front Axle

Roda / Rueda / Wheel	•		2.3L * 90...94	LM 67048 / LM 67010		TRB
		•	2.3L * 90...94	LM 11949 / LM 11910		TRB
	•		2.3L * 95...	LM 48548 / LM 48510		TRB
		•	2.3L * 95...	LM 11949 / LM 11910		TRB
	•		2.5L * 98...00	LM 48548 / LM 48510		TRB
		•	2.5L * 98...00	LM 11949 / LM 11910		TRB
	•		3.0L * 91...94	LM 67048 / LM 67010		TRB
		•	3.0L * 91...94	LM 11949 / LM 11910		TRB
	•		3.0L * 95...02	LM 48548 / LM 48510		TRB
		•	3.0L * 95...02	LM 11949 / LM 11910		TRB
	•		3.8L * 91...94	LM 67048 / LM 67010		TRB
		•	3.8L * 91...94	LM 11949 / LM 11910		TRB



Motor / Motor / Engine

Alternador (dianteiro) / Alternador (delantero) / Alternator (front)			2.5 D 85A * 97...	6203 2RS / C3		BB
Alternador (traseiro) / Alternador (trasero) / Alternator (rear)			2.5 D 85A * 97...	6003 2RS / C3		BB

Royale

Eixo Traseiro / Eje Trasero / Rear Axle

Roda / Rueda / Wheel				KA 069		KIT
		•	1.8 * 2.0L * 91...97	L 45449 / L 45410		TRB
	•		1.8 * 2.0L * 91...97	LM 11749 / LM 11710		TRB

	OUT	IN		Fersa [®]	Nº OEM	
---	-----	----	---	---------------------------	--------	---

FORD

Royale

Motor / Motor / Engine

Alternador - lado coletor / Alternador - lado colector / Alternator - manifold			Opcional 6201 2ZR / C3	6201 2RS / C3	ZBC903221	BB
Alternador - lado polia / Alternador - polea / Alternator - pulley			Bosch	6203 2RS / C3	7RA10094A	BB

Rural

Eixo Dianteiro / Eje Delantero / Front Axle

Roda / Rueda / Wheel			4 x 4	11590 / 11520	16176	TRB
----------------------	--	--	-------	----------------------	-------	-----

Motor / Motor / Engine

Alternador (dianteiro) / Alternador (delantero) / Alternator (front)			Wapsa - 4 x 4	6203 2RS / C3	80227	BB
			Bosch - 4 x 4	6203 2RS / C3	84989	BB
Alternador (traseiro) / Alternador (trasero) / Alternator (rear)			Wapsa - 4 x 4	6200 2RS / C3	80235	BB
			Bosch - 4 x 4	6201 2RS / C3	84990	BB
Dinamo (dianteiro) / Dinamo (delantero) / Dynamo (front)			4 x 4	6203 ZZ	84989	BB
			4 x 4	6202	80339	BB

Rural (4X2 * 4X4)

Caixa de transferência / Caja de Transferencia / Transfer Case

			4 x 4	14131 / 14276		TRB
--	--	--	-------	----------------------	--	-----

Câmbio / Caja de Cambios / Gearbox

Eixo secund (traseiro) / Eje secundario (trasero) / Secondary shaft (rear)				6206 C3		BB
--	--	--	--	----------------	--	----

Diferencial / Diferencial / Differential

Coroa lateral (dir./esq.) / Lateral corona (der./izq.) / Crown gear (right/left)				25577 / 25523		TRB
Pinhão cônico (traseiro) / Piñón cónico (trasero) / Bevel gear (rear)				31594 / 31520		TRB

Motor / Motor / Engine

Alternador (dianteiro) / Alternador (delantero) / Alternator (front)			Wapsa	6203 2RS / C3		BB
			Opcional 6203 ZZ / C3 (Bosch)	6203 2RS / C3		BB
Alternador (traseiro) / Alternador (trasero) / Alternator (rear)			73... Wapsa	6200 2RS / C3		BB
			Opcional 6203 ZZ / C3 (Bosch)	6201 2RS / C3		BB
Dinamo (dianteiro) / Dinamo (delantero) / Dynamo (front)			60...65	6203 2RS / C3		BB
			64...65	6202		BB

Scala

Câmbio / Caja de Cambios / Gearbox

				32304 F	BD1M7A453A	TRB
--	--	--	--	----------------	------------	-----

Eixo Dianteiro / Eje Delantero / Front Axle

Roda / Rueda / Wheel		•		LM 78349 / LM 78310 A	11427548/11427549	TRB
	•			LM 78349 / LM 78310 A	11427548/11427549	TRB

Eixo Traseiro / Eje Trasero / Rear Axle

Roda / Rueda / Wheel		•		L 44649 / L 44610	527994/527995	TRB
	•			LM 11949 / LM 11910	B5A1216A / B5A1217A	TRB

	OUT	IN		Fersa [®]	N° OEM	
---	-----	----	---	---------------------------	--------	---

FORD

Scala

Motor / Motor / Engine

Alternador (dianteiro) / Alternador (delantero) / Alternator (front)			Wapsa	6203 2RS / C3	80227	BB
Alternador (traseiro) / Alternador (trasero) / Alternator (rear)			Wapsa	6200 2RS / C3	80235	BB

Sierra (L * XR3 * S)

Câmbio / Caja de Cambios / Gearbox

Eixo primário (dianteiro) / Eje primario (delantero) / Primary shaft (front)				6207 ZNR		BB
--	--	--	--	----------	--	----

Diferencial / Diferencial / Differential

Coroa lateral (dir./esq.) / Lateral corona (dcho./ izdo.) / Crown gear (right/left)				LM 501349 / LM 501314		TRB
Pinhão cônico (traseiro) / Piñón cónico (trasero) / Bevel gear (rear)				HM 88542 / HM 88510		TRB
				HM 88649 / HM 88620		TRB

Motor / Motor / Engine

Alternador (dianteiro) / Alternador (delantero) / Alternator (front)			Indiel	6203 2RS / C3		BB
Alternador (traseiro) / Alternador (trasero) / Alternator (rear)			Indiel	6203 2RS / C3		BB

Taurus

Eixo Dianteiro / Eje Delantero / Front Axle

Roda / Rueda / Wheel			3.8L * 88...89	F 16194		BBDRAC
			3.8L * 90...91	F 16194		BBDRAC

Eixo Traseiro / Eje Trasero / Rear Axle

Roda / Rueda / Wheel	•		3.8L * 88...89	LM 67048 / LM 67010		TRB
		•	3.8L * 88...89	LM 12749 / LM 12710		TRB

Thunderbird

Eixo Dianteiro / Eje Delantero / Front Axle

Roda / Rueda / Wheel	•		3.8L * 85...88	LM 48548 / LM 48510		TRB
		•	3.8L * 85...88	LM 12749 / LM 12710		TRB

Eixo Traseiro / Eje Trasero / Rear Axle

Roda / Rueda / Wheel			89...90	F 16194		BBDRAC
			3.8L * 89...94	F 16194		BBDRAC
			4.6L * 95...96	F 16194		BBDRAC
			5.0L * 91...94	F 16194		BBDRAC

Topaz

Eixo Traseiro / Eje Trasero / Rear Axle

Roda / Rueda / Wheel	•		2.3L * 85...94	L 45449 / L 45410		TRB
		•	2.3L * 85...94	LM 12749 / LM 12710		TRB

Verona

Câmbio / Caja de Cambios / Gearbox

				LM 29749 / LM 29710	003519185	TRB
Eixo secundário - lado volante / Eje secundario - lado volante / Secondary shaft - steering wheel				L 45449 / L 45410	311405625C	TRB

Eixo Dianteiro / Eje Delantero / Front Axle

Roda / Rueda / Wheel				KA 019		KIT
			1.6 * 1.8L	F 15036	81AB1215AB	TRBS

	OUT	IN		Fersa [®]	Nº OEM	
---	-----	----	---	---------------------------	--------	---

FORD

Verona

Eixo Traseiro / Eje Trasero / Rear Axle

Roda / Rueda / Wheel				KA 075		KIT
	•			L 45449 / L 45410	72GB1200AA	TRB
	•	1.6 * 1.8L * 89...96		L 45449 / L 45410	72GB1200AA	TRB
	•			LM 11749 / LM 11710	11527972	TRB

Motor / Motor / Engine

Alternador - lado coletor / Alternador - lado colector / Alternador - manifold			1.6 * 1.8L * Opc. 6201 ZZ / C3	6201 2RS / C3	ZBC903221	BB
Alternador - polia / Alternador - polea / Alternador - pulley				6203 2RS / C3	7RA10094A	BB
			1.6 * 1.8L	6203 2RS / C3	80227	BB

Versailles

Diferencial / Diferencial / Differential

Coroa lateral (dir./esq.) / Lateral corona (der./izq.) / Crown gear (right/left)				LM 300849 / LM 300811		TRB
--	--	--	--	------------------------------	--	-----

Eixo Traseiro / Eje Trasero / Rear Axle

Roda / Rueda / Wheel				KA 069		KIT
	•	1.8 * 2.0L * 91...97		L 45449 / L 45410		TRB
	•			LM 11749 / LM 11710		TRB

Motor / Motor / Engine

Alternador - lado coletor / Alternador - lado colector / Alternador - manifold			Bosch * Opc. 6201 ZZ / C3	6201 2RS / C3	ZBC903221	BB
Alternador - polia / Alternador - polea / Alternador - pulley			Bosch	6203 2RS / C3	7RA10094A	BB

Windstar

Eixo Dianteiro / Eje Delantero / Front Axle

Roda / Rueda / Wheel			3.8L * 95...98	F 16194		BBDRAC
----------------------	--	--	----------------	----------------	--	--------

Eixo Traseiro / Eje Trasero / Rear Axle

Roda / Rueda / Wheel	•		3.8L * 95...98	LM 67048 / LM 67010		TRB
		•	3.8L * 95...98	LM 12749 / LM 12710		TRB



	OUT	IN		Fersa [®]	N° OEM	
---	-----	----	---	---------------------------	--------	---

GENERAL MOTORS

A-C-D (10* 14* 15* 20* 40*) Bonanza * Veraneio* D1000

Câmbio / Caja de Cambios / Gearbox

				M 802048 / M 802011	3342148	TRB
				2789 / 2720	93209057	TRB

Diferencial / Diferencial / Differential

Pinhão dianteiro / Piñón delantero / Front pinion				M 802048 / M 802011	9418356	TRB
---	--	--	--	--------------------------------	---------	-----

Eixo Dianteiro / Eje Delantero / Front Axle

Roda / Rueda / Wheel		•		LM 501349 / LM 501310	9420095	TRB
			•	LM 48548 / LM 48510	457052	TRB
			•	3982 / 3920	94630960	TRB
		•		M 12649 / M 12610	457049	TRB
		•		LM 11949 / LM 11910	111055109	TRB
		•		368 A / 362 A	94630962	TRB

Motor / Motor / Engine

Polia tensora (lado coletor) / Polea tensora (lado colector) / Tensioner pulley (manifold)				6205 Z	94642765	BB
---	--	--	--	---------------	----------	----

Astra

Diferencial / Diferencial / Differential

Coroa lateral (dir./esq.) / Lateral corona (der./izq.) / Crown gear (right/left)				JL 69349 / JL 69310		TRB
---	--	--	--	--------------------------------	--	-----

Eixo Traseiro / Eje Trasero / Rear Axle

Roda / Rueda / Wheel		•	2.0L - 16V	L 45449 / L 45410	11070311	TRB
		•	2.0L - 16V	LM 11749 / LM 11710	9415135	TRB

Motor / Motor / Engine

Alternador (dianteiro) / Alternador (delantero) / Alternator (front)			70A	6203 2RS / C3		BB
Alternador (traseiro) / Alternador (trasero) / Alternator (rear)			70 * 120A	6003 2RS / C3		BB
			70A	6203 2RS / C3		BB

Aveo

Eixo Dianteiro / Eje Delantero / Front Axle

Roda / Rueda / Wheel			1.6L * 08...	F 16019		BBDRAC
----------------------	--	--	--------------	----------------	--	--------

Blazer

Eixo Dianteiro / Eje Delantero / Front Axle

Roda / Rueda / Wheel	•		4.1L * 81...84	LM 48548 / LM 48510		TRB
		•	4.1L * 81...84	M 12649 / M 12610		TRB

Blazer * Gran Blazer

Diferencial / Diferencial / Differential

Pinhão cônico (dianteiro) / Piñón cónico (delantero) / Bevel gear (front)			2.2	M 802048 / M 802011		TRB
Pinhão cônico (traseiro) / Piñón cónico (trasero) / Bevel gear (rear)				31594 / 31520		TRB
			2.2	M 88048 / M 88010		TRB

Motor / Motor / Engine

Alternador (dianteiro) / Alternador (delantero) / Alternator (front)			65 * 75A Bosch	6203 2RS / C3		BB
			85A Bosch	6303 2RS / C3		BB

	OUT	IN		Fersa [®]	N° OEM	
---	-----	----	---	---------------------------	--------	---

GENERAL MOTORS

Blazer * Gran Blazer

Alternador (traseiro) / Alternador (trasero) / Alternator (rear)			85A Bosch	6001 2RS / C3		BB
			65 * 75A Bosch	6201 2RS / C3		BB

C 1500

Eixo Dianteiro / Eje Delantero / Front Axle

Roda / Rueda / Wheel	•		4.1L * 81...94	LM 48548 / LM 48510		TRB
		•	4.1L * 81...94	M 12649 / M 12610		TRB

Eixo Traseiro / Eje Trasero / Rear Axle

Roda / Rueda / Wheel			4.1L * 95...98	U 399 / U 360 L		U Series
----------------------	--	--	----------------	-----------------	--	----------

C 2500

Eixo Dianteiro / Eje Delantero / Front Axle

Roda / Rueda / Wheel	•		5.7L * 95...00	LM 48548 / LM 48510		TRB
		•	5.7L * 95...00	M 12649 / M 12610		TRB

Eixo Traseiro / Eje Trasero / Rear Axle

Roda / Rueda / Wheel	•		5.7L * 95...00	387 A / 382 A		TRB
		•	5.7L * 95...00	LM 104949 / LM 104911		TRB

C 3500

Eixo Dianteiro / Eje Delantero / Front Axle

Roda / Rueda / Wheel	•		5.7L * 95...00	LM 501349 / LM 501310		TRB
		•	5.7L * 95...00	15103 S / 15243		TRB

Eixo Traseiro / Eje Trasero / Rear Axle

Roda / Rueda / Wheel	•		5.7L * 95...00	387 A / 382 A		TRB
		•	5.7L * 95...00	LM 104949 / LM 104911		TRB

Caprice

Eixo Dianteiro / Eje Delantero / Front Axle

Roda / Rueda / Wheel	•		5.7L * 80...82	LM 67048 / LM 67010		TRB
		•	5.7L * 80...82	LM 11949 / LM 11910		TRB

Caravan * Opala

Câmbio / Caja de Cambios / Gearbox

Eixo piloto / Eje piloto / Pilot shaft			2.5L	6206 NR 2RS	3315572	BB
			4.1L	LM 300849 / LM 300811	3317060(int)/58(ext)	TRB
Eixo primário / Eje primario / Primary shaft			2.5L	6207 NR 2RS	3317150	BB
			4.1L	LM 78349 / LM 78310 A	3317059	TRB
			4.1L	6206 2RS / C3	3317064	BB
			2.5L	6305 C3	3315386	BB
Eixo primário / Eje primario / Primary shaft			74...87	6306 ZNR / C3		BB
Eixo secund. / Eje secundario / Secondary shaft			74...87	6306 NR		BB
Eixo secund. (traseiro) / Eje secundario (trasero) / Secondary shaft (rear)			...70	6206 NR		BB
Eixo primário / Eje primario / Primary shaft				6306 NR 2RS / C3		BB
Eixo primário (dianteiro) / Eje primario (delantero) / Primary shaft (front)			74...82 (serie 109543...) * 82... * 74...87	6306 ZNR / C3		BB
Eixo secund / Eje secundario / Secondary shaft			74...82	6306 NR 2RS / C3		BB

	OUT	IN		Fersa [®]	N° OEM	
---	-----	----	---	---------------------------	--------	---

GENERAL MOTORS

Caravan * Opala

Eixo secund (traseiro) / Eje secundario (trasero) / Secondary shaft (rear)			...70	6206 NR		BB
Eixo primário / Eje primario / Primary shaft				6305 C3		BB
Eixo secund (traseiro) / Eje secundario (trasero) / Secondary shaft (rear)				6306 NR 2RS / C3		BB
				6305 C3		BB

Diferencial / Diferencial / Differential

Coroa lat. (dir./esq.) / Lateral corona (der./izq.) / Crown gear (right/left)			79...	LM 501349 / LM 501314		TRB
Pinhão cônico (dianteiro) / Piñón cónico (delantero) / Bevel gear (front)			79...	M 86647 / M 86610		TRB
Pinhão cônico (traseiro) / Piñón cónico (trasero) / Bevel gear (rear)			79...	HM 88649 / HM 88610		TRB
			75...78	M 88048 / M 88010		TRB
			2.5 * 4.1L	LM 29749 / LM 29711		TRB
			Albarus M30	LM 501349 / LM 501314		TRB
Coroa lat. (dir./esq.) / Lateral corona (der./izq.) / Crown gear (right/left)				LM 11749 / LM 11710		TRB
Pinhão cônico (dianteiro) / Piñón cónico (delantero) / Bevel gear (front)				M 84548 / M 84510		TRB
Pinhão cônico (traseiro) / Piñón cónico (trasero) / Bevel gear (rear)			74... (serie 102285...)	M 88048 / M 88010		TRB

Eixo Dianteiro / Eje Delantero / Front Axle

Roda / Rueda / Wheel	●		2.5 * 4.1L	L 44649 / L 44610	9415132	TRB
	●		2.5 * 4.1L	LM 67048 / LM 67010	110555119	TRB
	●		2.5 * 4.1L	LM 11749 / LM 11710	9415135	TRB
	●		2.5 * 4.1L	LM 11949 / LM 11910	111055109	TRB

Motor / Motor / Engine

Alternador (dianteiro) / Alternador (delantero) / Alternator (front)			Opc. 6203 ZZ / C3 (Bosch)	6203 2RS / C3		BB
Alternador - lado polia / Alternador - lado polea / Alternator - pulley			2.5 * 4.1L Bosch	6203 2RS / C3	904751/9462046	BB

Celta * Classic * Corsa * Corsa Sedan * Pick-up Corsa

Eixo Traseiro / Eje Trasero / Rear Axle

Roda / Rueda / Wheel				KA 038		KIT
	●		1.0 * 1.4 * 1.6L	L 45449 / L 45410	11070311	TRB
	●		1.0 * 1.4 * 1.6L	LM 11749 / LM 11710	9415135	TRB

Chevette * Chevette Junior * Chevy 500 * Marajó

Câmbio / Caja de Cambios / Gearbox

Eixo piloto / Eje piloto / Pilot shaft				6206 NR 2RS	3315573	BB
Eixo primário / Eje primario / Primary shaft				6207 NR 2RS	3317150	BB

Diferencial / Diferencial / Differential

				LM 29749 / LM 29711		TRB
--	--	--	--	----------------------------	--	-----

Eixo Dianteiro / Eje Delantero / Front Axle

Roda / Rueda / Wheel				KA 040		KIT
	●			L 44649 / L 44610	9415132	TRB

	OUT	IN		Fersa®	Nº OEM	
---	-----	----	---	---------------	--------	---

GENERAL MOTORS

Chevette * Chevette Junior * Chevy 500 * Marajó

Roda / Rueda / Wheel	•			LM 11749 / LM 11710	9415135	TRB
----------------------	---	--	--	----------------------------	---------	-----

Motor / Motor / Engine

Alternador (lado polia) / Alternador (lado polea) / Alternator (pulley)			1.6L Bosch	6203 2RS / C3	904751/9462046	BB
---	--	--	------------	----------------------	----------------	----

Câmbio / Caja de Cambios / Gearbox

Eixo primário / Eje primario / Primary shaft				6206 NR		BB
--	--	--	--	----------------	--	----

Chevy

Eixo Dianteiro / Eje Delantero / Front Axle

Roda / Rueda / Wheel			1.4L * 94...01	F 16020		BBDRAC
			1.6L * 96...	F 16020		BBDRAC

Eixo Traseiro / Eje Trasero / Rear Axle

Roda / Rueda / Wheel	•		1.4L * 94...01	L 45449 / L 45410		TRB
		•	1.4L * 94...01	LM 11749 / LM 11710		TRB
	•		1.6L * 96...	L 45449 / L 45410		TRB
		•	1.6L * 96...	LM 11749 / LM 11710		TRB

Corsa

Eixo Dianteiro / Eje Delantero / Front Axle

Roda / Rueda / Wheel			1.8L * 03...08	F 16083		BBDRAC
----------------------	--	--	----------------	----------------	--	--------

Eixo Traseiro / Eje Trasero / Rear Axle

Roda / Rueda / Wheel			1.8L * 03...08	F 15128		TRBDR
----------------------	--	--	----------------	----------------	--	-------

Corsa (hatch * pick-up * sedan)

Câmbio / Caja de Cambios / Gearbox

Eixo secund. (esq.) / Eje secundario (izq.) / Secondary shaft (left)				6305 C3		BB
--	--	--	--	----------------	--	----

Diferencial / Diferencial / Differential

Coroa lateral (dir./esq.) / Lateral corona (der./izq.) / Crown gear (right/left)				32007 XF		TRB
--	--	--	--	-----------------	--	-----

Motor / Motor / Engine

Alternador (dianteiro) / Alternador (delantero) / Alternator (front)			55A 1.0 * 1.6 (94...)	6203 2RS / C3		BB
Alternador (traseiro) / Alternador (trasero) / Alternator (rear)			70 * 120 A	6003 2RS / C3		BB
			55 * 100 A	6203 2RS / C3		BB
			55A	6201 2RS / C3		BB
			Delco	6202 2RS / C3		BB

Corsa Novo * Meriva * Montana

Eixo Dianteiro / Eje Delantero / Front Axle

Roda / Rueda / Wheel				F 16083	93362342	BBDRAC
----------------------	--	--	--	----------------	----------	--------

D 10



Diferencial / Diferencial / Differential

Dianteiro Coroa lat. (dir./esq.) / Delantero lateral corona (der./izq.) / Front Crown gear (right/left)			85... (sim/sin/without 4X4)	368 A / 362 X		TRB
Dianteiro Pinhão cônico (dianteiro) / Delantero piñón cónico (delantero) / Front bevel gear (front)			85... (sim/sin/without 4X4)	M 802048 / M 802011		TRB
			85... (sim/sin/without 4X4)	M 88048 / M 88010		TRB

D 20 (Bonanza * Veraneio)

Câmbio / Caja de Cambios / Gearbox

Eixo secund. / Eje secundario / Secondary shaft				6308 NR		BB
---	--	--	--	----------------	--	----

	OUT	IN		Fersa [®]	N° OEM	
---	-----	----	---	---------------------------	--------	---

GENERAL MOTORS

D 20 (Bonanza * Veraneio)

Eixo primário (traseiro) / Eje primario (traseiro) / Primary shaft (rear)			Clark 85...91	6308 NR		BB
---	--	--	---------------	---------	--	----

Diferencial / Diferencial / Differential

Dianteiro Coroa lat. (dir./esq.) / Delantero lateral corona (der./izq.) / Front Crown gear (right/left)			85... (sim/sin/without 4X4)	368 A / 362 X		TRB
Dianteiro Pinhão cônico (dianteiro) / Delantero piñón cónico (delantero) / Front bevel gear (front)			88...90	31594 / 31520		TRB
			85... (sim/sin/without 4X4)	M 802048 / M 802011		TRB
			88...90 (4X4)	M 802048 / M 802011		TRB
			85... (sim/sin/without 4X4)	M 88048 / M 88010		TRB
			88...90	M 88048 / M 88010		TRB

D 40

Câmbio / Caja de Cambios / Gearbox

Eixo intermediário (traseiro) / Eje Intermediario (traseiro) / Intermediate shaft (rear)			85...91	6308 NR		BB
--	--	--	---------	---------	--	----

Diferencial / Diferencial / Differential

Dianteiro Pinhão cônico (dianteiro) / Delantero piñón cónico (delantero) / Front bevel gear (front)			85...	HM 807046 / HM 807010		TRB
---	--	--	-------	-----------------------	--	-----

Motor / Motor / Engine

Polia tensora (compres. ar) / Polea tensora (compresor aire acondicionado) / Tensioner pulley (air conditioner)				6205 Z		BB
---	--	--	--	--------	--	----

Express Van

Eixo Traseiro / Eje Trasero / Rear Axle

Roda / Rueda / Wheel	•		6.0L * 03...	387 A / 382 A		TRB
		•	6.0L * 03...	LM 104949 / LM 104911		TRB

Ipanema * Kadett * Monza (1.8 * 2.0)

Diferencial / Diferencial / Differential

Coroa lateral (dir./esq.) / Lateral corona (der./izq.) / Crown gear (right/left)				JL 69349 / JL 69310		TRB
--	--	--	--	---------------------	--	-----

Motor / Motor / Engine

Alternador (dianteiro) / Alternador (delantero) / Alternator (front)			Bosch	6203 2RS / C3		BB
Alternador (traseiro) / Alternador (traseiro) / Alternator (rear)			Bosch	6201 2RS / C3		BB

Luv

Eixo Dianteiro / Eje Delantero / Front Axle

Roda / Rueda / Wheel	•		2.2L * 99...05	LM 48548 / LM 48510		TRB
		•	2.2L * 99...05	M 12649 / M 12610		TRB
	•		2.3L * 97...98	LM 48548 / LM 48510		TRB
		•	2.3L * 97...98	M 12649 / M 12610		TRB

Marajó (1.0 * 1.4 * 1.6)

Câmbio / Caja de Cambios / Gearbox

Eixo intermediário (traseiro) / Eje Intermediario (traseiro) / Intermediate shaft (rear)			73...91	6206 NR		BB
Eixo primário / Eje primario / Primary shaft			82...	6206 NR		BB
Eixo primário (traseiro) / Eje primario (traseiro) / Primary shaft (rear)			82...91	6206 NR		BB
Eixo secund. (traseiro) / Eje secundario (traseiro) / Secondary shaft (rear)			73...91	6206 NR		BB

	OUT	IN		Fersa [®]	Nº OEM	
---	-----	----	---	---------------------------	--------	---

GENERAL MOTORS

Marajó (1.0 * 1.4 * 1.6)

Diferencial / Diferencial / Differential

Eixo primário (traseiro) / Eje primario (trasero) / Primary shaft (rear)			84...	M 88048 / M 88010		TRB
Coroa lat. (dir./esq.) / Lateral corona (der./izq.) / Crown gear (right/left)				LM 11749 / LM 11710		TRB
Pinhão cônico (dianteiro) / Piñón cónico (delantero) / Bevel gear (front)				M 84548 / M 84510		TRB

Direção / Dirección / Steering

			76... (ZF)	6201		BB
--	--	--	------------	-------------	--	----

Motor / Motor / Engine

Alternador (dianteiro) / Alternador (delantero) / Alternator (front)			Opc. 6203 ZZ / C3	6203 2RS / C3		BB
--	--	--	-------------------	----------------------	--	----

Meriva

Eixo Dianteiro / Eje Delantero / Front Axle

Roda / Rueda / Wheel			1.8L * 04...06	F 16083		BBDRAC
----------------------	--	--	----------------	----------------	--	--------

Monza * Kadett * Ipanema

Eixo Traseiro / Eje Trasero / Rear Axle

Roda / Rueda / Wheel				KA 038		KIT
		•		L 45449 / L 45410	11070311	TRB
	•			LM 11749 / LM 11710	9415135	TRB

Motor / Motor / Engine

Alternador - coletor / Alternador - colector / Alternator - manifold			1.8 * 2.0L Bosch	6201 2RS / C3	94626055/52252884	BB
Alternador (lado polia) / Alternador (lado polea) / Alternator (pulley)			1.8 * 2.0L Bosch	6203 2RS / C3	522528884	BB
			1.8 * 2.0L Arno	6203 2RS / C3	94648617	BB

Omega * Omega Suprema (2.0 * 2.2 * 3.0 * 4.1)

Diferencial / Diferencial / Differential

Pinhão cônico (traseiro) / Piñón cónico (trasero) / Bevel gear (rear)			3.0e 4.1	HM 89449 / HM 89410		TRB
---	--	--	----------	----------------------------	--	-----

Motor / Motor / Engine

Alternador (dianteiro) / Alternador (delantero) / Alternator (front)			70 * 90 A	6201 N 2RS / C3		BB
			90A com/con/with AC	6303 2RS / C3		BB
Alternador (traseiro) / Alternador (trasero) / Alternator (rear)			70 * 90 A	6201 N 2RS / C3		BB
			3.0e 4.1 120A com/con/with AC	6203 2RS / C3		BB

Omega * Suprema

Diferencial / Diferencial / Differential

				HM 89449 / HM 89410	98461/98449	TRB
--	--	--	--	----------------------------	-------------	-----

Eixo Traseiro / Eje Trasero / Rear Axle

Roda / Rueda / Wheel			3.0 * 4.1L	F 16032	90235281	BBDRAC
			3.0L	F 16032	9023714	BBDRAC

Motor / Motor / Engine

Alternador - coletor / Alternador - colector / Alternator - manifold			2.0 * 3.0L * Opc. 6201 ZZ / C3	6201 2RS / C3	1205225	BB
--	--	--	-----------------------------------	----------------------	---------	----

Optra

Eixo Dianteiro / Eje Delantero / Front Axle

Roda / Rueda / Wheel			2.0L * 06...	F 16037		BBDRAC
----------------------	--	--	--------------	----------------	--	--------

	OUT	IN		Fersa [®]	N° OEM	
---	-----	----	---	---------------------------	--------	---

GENERAL MOTORS

P 30

Eixo Dianteiro / Eje Delantero / Front Axle

Roda / Rueda / Wheel	●		4.1L * 1998	LM 501349 / LM 501310		TRB
		●	4.1L * 1998	15103 S / 15243		TRB
	●		4.3L * 98...02	LM 501349 / LM 501310		TRB
		●	4.3L * 98...02	15103 S / 15243		TRB
	●		5.7L * 95...02	LM 501349 / LM 501310		TRB
		●	5.7L * 95...02	15103 S / 15243		TRB

Eixo Traseiro / Eje Trasero / Rear Axle

Roda / Rueda / Wheel	●		4.1L * 1998	387 A / 382 A		TRB
		●	4.1L * 1998	LM 104949 / LM 104911		TRB
	●		4.3L * 98...02	387 A / 382 A		TRB
		●	4.3L * 98...02	LM 104949 / LM 104911		TRB
	●		5.7L * 95...02	387 A / 382 A		TRB
		●	5.7L * 95...02	LM 104949 / LM 104911		TRB

S 10

Eixo Dianteiro / Eje Delantero / Front Axle

Roda / Rueda / Wheel	●		2.2L * 95...03	LM 67048 / LM 67010		TRB
		●	2.2L * 95...03	LM 12748 / LM 12710		TRB
	●		3.1L * 91...93	LM 67048 / LM 67010		TRB
		●	3.1L * 91...93	LM 12748 / LM 12710		TRB
	●		4.3L * 1999	LM 67048 / LM 67010		TRB
		●	4.3L * 1999	LM 12748 / LM 12710		TRB

S 10 (2.2 * 2.4 * 2.5 * 2.8 TD * 4.3)

Câmbio / Caja de Cambios / Gearbox

Eixo secund. (dianteiro) / Eje secundario (delantero) / Secondary shaft (front)			2.2e 2.5	LM 11949 / LM 11910		TRB
Eixo secund. (traseiro) / Eje secundario (trasero) / Secondary shaft (rear)			2.2e 2.5	6206 2RS / C3		BB

Motor / Motor / Engine

Alternador (dianteiro) / Alternador (delantero) / Alternator (front)			65 * 75A Bosch	6203 2RS / C3		BB
			85A Bosch	6303 2RS / C3		BB
Alternador (traseiro) / Alternador (trasero) / Alternator (rear)			85A Bosch	6001 2RS / C3		BB
			65 * 75A Bosch	6201 N 2RS / C3		BB

S 10 * Blazer

Câmbio / Caja de Cambios / Gearbox

				2789 / 2720	93209057	TRB
				LM 78349 / LM 78310 A	3317059(int) / 64(ext)	TRB
Eixo secundário (dianteiro) / Eje secundario (delantero) / Secondary shaft (front)			2.2 * 2.5L	LM 11949 / LM 11910	3312851	TRB
			2.2 * 2.5L	6206 2RS / C3	3317084	BB

	OUT	IN		Fersa [®]	N° OEM	
---	-----	----	---	---------------------------	--------	---

GENERAL MOTORS

S 10 * Blazer

Diferencial / Diferencial / Differential

Lateral coroa / Lateral corona / Crown gear			Albarus 35	LM 501349 / LM 501310		TRB
Pinhão dianteiro / Piñón delantero / Front pinion				M 802048 / M 802011	93225220	TRB

Eixo Dianteiro / Eje Delantero / Front Axle

Roda / Rueda / Wheel		•	4 x 2	LM 67048 / LM 67010	00457194/5	TRB
	•		4 x 2	M 12649 / M 12610	457047/8	TRB

Silverado

Câmbio / Caja de Cambios / Gearbox

Eixo intermediário (traseiro) / Eje Intermediario (traseiro) / Intermediate shaft (rear)				6306 NR		BB
			FSO 2305	M 802048 / M 802011	3342147/46	TRB
				6306 NR	907791	BB
Eixo primário (dianteiro) / Eje primario (delantero) / Primary shaft (front)				6207 ZN / C3		BB

Diferencial / Diferencial / Differential

Coroa lateral (dir./esq.) / Lateral corona (der./izq.) / Crown gear (right/left)			Eaton	LM 603049 / LM 603012		TRB
Pinhão cônico (dianteiro) / Piñón cónico (delantero) / Bevel gear (front)			Eaton	M 86649 / M 86610		TRB
Pinhão cônico (traseiro) / Piñón cónico (traseiro) / Bevel gear (rear)			Transax	31594 / 31520		TRB
			Eaton	M 802048 / M 802011		TRB
Pinhão traseiro / Piñón trasero / Rear Pinion				31594 / 31520	9415470/477080	TRB
			Eaton	M 802048 / M 802011	7451155	TRB

Eixo Dianteiro / Eje Delantero / Front Axle

Roda / Rueda / Wheel		•		LM 67048 / LM 67010	7450632/631	TRB
	•			M 12649 / M 12610	7450687/695	TRB
Eixo Traseiro / Eje Trasero / Rear Axle						
Roda / Rueda / Wheel		•		3982 / 3920	94630960	TRB
	•			368 A / 362 A	94630962	TRB

Motor / Motor / Engine

Alternador (dianteiro) / Alternador (delantero) / Alternator (front)			Bosch 65 * 75 A	6203 2RS / C3		BB
Alternador (traseiro) / Alternador (traseiro) / Alternator (rear)			Bosch 65 * 75 A	6201 2RS / C3		BB

Silverado 2500

Eixo Traseiro / Eje Trasero / Rear Axle

Roda / Rueda / Wheel	•		4.8L * 03...09	387 A / 382 A		TRB
		•	4.8L * 03...09	LM 104949 / LM 104911		TRB
	•		5.3L * 03...09	387 A / 382 A		TRB
		•	5.3L * 03...09	LM 104949 / LM 104911		TRB

Silverado 3500

Eixo Traseiro / Eje Trasero / Rear Axle

Roda / Rueda / Wheel	•		5.7L * 05...07	387 A / 382 A		TRB
		•	5.7L * 05...07	LM 104949 / LM 104911		TRB

	OUT	IN		Fersa [®]	N° OEM	
---	-----	----	---	---------------------------	--------	---

GENERAL MOTORS

Silverado 3500

Roda / Rueda / Wheel	●		6.0L * 08...09	387 A / 382 A		TRB
		●	6.0L * 08...09	LM 104949 / LM 104911		TRB
	●		8.1L * 05...06	387 A / 382 A		TRB
		●	8.1L * 05...06	LM 104949 / LM 104911		TRB

Suburban

Eixo Traseiro / Eje Trasero / Rear Axle

Roda / Rueda / Wheel	●		5.3L * 05...09	387 A / 382 A		TRB
		●	5.3L * 05...09	LM 104949 / LM 104911		TRB
	●		6.0L * 08...09	387 A / 382 A		TRB
		●	6.0L * 08...09	LM 104949 / LM 104911		TRB

Tigra

Diferencial / Diferencial / Differential

Coroa lateral (dir./esq.) / Lateral corona (der./izq.) / Crown gear (right/left)				32007 XF		TRB
--	--	--	--	-----------------	--	-----

Eixo Dianteiro / Eje Delantero / Front Axle

Roda / Rueda / Wheel			1.6L * 1999	F 16020		BBDRAC
----------------------	--	--	-------------	----------------	--	--------

Eixo Traseiro / Eje Trasero / Rear Axle

Roda / Rueda / Wheel	●		1.6L * 1999	L 45449 / L 45410		TRB
		●	1.6L * 1999	LM 11749 / LM 11710		TRB

Motor / Motor / Engine

Alternador (traseiro) / Alternador (trasero) / Alternator (rear)			70 * 120 A	6003 2RS / C3		BB
			55 A	6201 2RS / C3		BB
				6203 2RS / C3		BB

Tornado

Eixo Dianteiro / Eje Delantero / Front Axle

Roda / Rueda / Wheel			1.8L * 04...	F 16083		BBDRAC
----------------------	--	--	--------------	----------------	--	--------

Vectra

Diferencial / Diferencial / Differential

Coroa lateral (dir./esq.) / Lateral corona (der./izq.) / Crown gear (right/left)				JL 69349 / JL 69310		TRB
--	--	--	--	----------------------------	--	-----

Motor / Motor / Engine

Alternador (dianteiro) / Alternador (delantero) / Alternator (front)			70 * 120 A	6303 2RS / C3		BB
Alternador (traseiro) / Alternador (trasero) / Alternator (rear)			70 * 120 A	6003 2RS / C3		BB
			70 * 120 A * 93...99	6203 2RS / C3		BB

Zafira (1.8 * 2.0)

Diferencial / Diferencial / Differential

Coroa lateral (dir./esq.) / Lateral corona (der./izq.) / Crown gear (right/left)				JL 69349 / JL 69310		TRB
--	--	--	--	----------------------------	--	-----

Motor / Motor / Engine

Alternador (dianteiro) / Alternador (delantero) / Alternator (front)			70A	6203 2RS / C3		BB
Alternador (traseiro) / Alternador (trasero) / Alternator (rear)			70 * 120A	6003 2RS / C3		BB
			70A	6203 2RS / C3		BB

	OUT	IN		Fersa [®]	Nº OEM	
---	-----	----	---	---------------------------	--------	---

GURGEL

BR 800

Eixo Dianteiro / Eje Delantero / Front Axle

Roda / Rueda / Wheel		•		L 45449 / L 45410	CAE412023	TRB
	•			LM 11749 / LM 11710	CAE412025	TRB

Motor / Motor / Engine

Tampa frontal / Tapa frontal / Front cover						BB
--	--	--	--	--	--	----

HONDA

Civic

Eixo Dianteiro / Eje Delantero / Front Axle

Roda / Rueda / Wheel				F 16052		BBDRAC
----------------------	--	--	--	---------	--	--------

HYUNDAI

H100

Eixo Traseiro / Eje Trasero / Rear Axle

Roda / Rueda / Wheel				U 399 / U 360 L		U series
----------------------	--	--	--	-----------------	--	----------

HR

Eixo Dianteiro / Eje Delantero / Front Axle

Roda / Rueda / Wheel		•	2.4L * 03...05	M 12649 / M 12610		TRB
	•		2.5L TDI * 06...	LM 48548 / LM 48510		TRB

JEEP

Comanche

Eixo Traseiro / Eje Trasero / Rear Axle

Roda / Rueda / Wheel			86...89	U 399 / U 360 L		U Series
----------------------	--	--	---------	-----------------	--	----------

KIA

Besta (2.2 * 2.7 * GS)

Câmbio / Caja de Cambios / Gearbox

Eixo primário (dir.) / Eje primario (der.) / Primary shaft (right)				6306 ZNR		BB
Eixo secund. (dir.) / Eje secundario (der.) / Secondary shaft (right)				6304 ZZ		BB
Eixo secund. (esq.) / Eje secundario (izq.) / Secondary shaft (left)				6205		BB
Pinhão cônico (dianteiro) / Piñón cónico (delantero) / Bevel gear (front)				30307 F		TRB
Pinhão cônico (traseiro) / Piñón cónico (trasero) / Bevel gear (rear)				30306 F		TRB

Sportage (2.0 * 2.2)

Diferencial / Diferencial / Differential

Coroa lateral (dir./esq.) / Lateral corona (der./izq.) / Crown gear (right/left)				32008 XF		TRB
Pinhão cônico (dianteiro) / Piñón cónico (delantero) / Bevel gear (front)				32207 F		TRB
Pinhão cônico (traseiro) / Piñón cónico (trasero) / Bevel gear (rear)				32206 F		TRB

	OUT	IN		Fersa [®]	N° OEM	
---	-----	----	---	---------------------------	--------	---

LADA

1600

Câmbio / Caja de Cambios / Gearbox

Eixo principal (traseiro) / Eje principal (traseiro) / Main shaft (rear)				6205	20715580	BB
--	--	--	--	-------------	----------	----

Eixo Dianteiro / Eje Delantero / Front Axle

Roda / Rueda / Wheel		•		32008 XF	21213103020	TRB
	•			LM 11949 / LM 11910	21013103025	TRB

Motor / Motor / Engine

Alternador (dianteiro) / Alternador (delantero) / Alternator (front)				6302 2RS / C3	24940230	BB
Alternador (traseiro) / Alternador (trasero) / Alternator (rear)			Opc. 6201 ZZ / C3	6201 2RS / C3	24940220	BB

Laika (1.6)

Câmbio / Caja de Cambios / Gearbox

Eixo secund. (dianteiro) / Eje secundario (delantero) / Secondary shaft (front)				6306 NR		BB
Eixo secund. (traseiro) / Eje secundario (trasero) / Secondary shaft (rear)				6205		BB

Cardan / Cardan / Cardan

Suporte / Soporte / Support				62205 2RS		BB
-----------------------------	--	--	--	------------------	--	----

Motor / Motor / Engine

Alternador (dianteiro) / Alternador (delantero) / Alternator (front)				6302 2RS / C3		BB
Alternador (traseiro) / Alternador (trasero) / Alternator (rear)				6201 2RS / C3		BB

Niva

Caixa de Transferência / Caja de Transferencia / Transfer Case

Diferencial (dianteiro) / Diferencial (delantero) / Differential (front)				6209 NR	21211802168	BB
Diferencial (traseiro) / Diferencial (trasero) / Differential (rear)				6209	21211802189	BB
Eixo de saída (dianteiro) / Eje de salida (delantero) / Output shaft (front)				6205	21211802208	BB
Caixa de Transferência / Caja de Transferencia / Transfer Case				6305	21211802208	BB
Eixo de saída (traseiro) / Eje de salida (trasero) / Output shaft (rear)				6205	21211802208	BB
				6305	21211802208	BB

Câmbio / Caja de Cambios / Gearbox

Eixo principal (traseiro) / Eje principal (traseiro) / Main shaft (rear)				6205	20715580	BB
Eixo secund. (dianteiro) / Eje secundario (delantero) / Secondary shaft (front)				6306 NR		BB
Eixo secund. (traseiro) / Eje secundario (trasero) / Secondary shaft (rear)				6205		BB

Eixo dir. e esq. / Eje derecho e izquierdo / Right and left axle

Semi Eixo (dir./esq.) / Semi eje (der./izq.) / Front Shaft (right/left)				6306 NR		BB
---	--	--	--	----------------	--	----

Embreagem / Embrague / Clutch

Apoio / Apoyo / Support				62202 2RS / C3		BB
-------------------------	--	--	--	-----------------------	--	----

Motor / Motor / Engine

Alternador (dianteiro) / Alternador (delantero) / Alternator (front)				6302 2RS / C3		BB
Alternador (traseiro) / Alternador (trasero) / Alternator (rear)				6201 2RS / C3		BB

Samara

Diferencial / Diferencial / Differential

Coroa lateral - (dir./esq.) / Lateral corona - (der./izq.) / Crown gear (right/left)				30207 F		TRB
--	--	--	--	----------------	--	-----

	OUT	IN		Fersa [®]	N° OEM	
---	-----	----	---	---------------------------	--------	---

LADA

Samara

Eixo Dianteiro / Eje Delantero / Front Axle

Roda / Rueda / Wheel			1.3 * 1.5L	32008 XF	21082902840	TRB
----------------------	--	--	------------	----------	-------------	-----

Motor / Motor / Engine

Alternador (dianteiro) / Alternador (delantero) / Alternator (front)				6302 2RS / C3		BB
Alternador (traseiro) / Alternador (trasero) / Alternator (rear)				6201 2RS / C3		BB

LAND ROVER

Defender 112

Eixo Dianteiro / Eje Delantero / Front Axle

Roda / Rueda / Wheel		•		LM 603049 / LM 603011	STC 4382	TRB
----------------------	--	---	--	-----------------------	----------	-----

Defender 114

Eixo Dianteiro / Eje Delantero / Front Axle

Roda / Rueda / Wheel	•			LM 603049 / LM 603011	STC 4382	TRB
----------------------	---	--	--	-----------------------	----------	-----

LINCOLN

MKX

Eixo Dianteiro / Eje Delantero / Front Axle

Roda / Rueda / Wheel			3.5L * 07...09	F 16088		BBDRAC
----------------------	--	--	----------------	---------	--	--------

MAZDA

Mazda3

Eixo Dianteiro / Eje Delantero / Front Axle

Roda / Rueda / Wheel			2.0L * 06...	F 16088		BBDRAC
			2.3L * 06...	F 16088		BBDRAC
			2.5L * 10...	F 16088		BBDRAC

Mazda5

Eixo Dianteiro / Eje Delantero / Front Axle



Roda / Rueda / Wheel			2.3L * 06...09	F 16088		BBDRAC
----------------------	--	--	----------------	---------	--	--------

Mazda6

Eixo Dianteiro / Eje Delantero / Front Axle

Roda / Rueda / Wheel			2.3L * 06...08	F 16088		BBDRAC
			3.0L * 06...08	F 16088		BBDRAC



	OUT	IN		Fersa®	Nº OEM	
---	-----	----	---	---------------	--------	---

MERCEDES BENZ

Classe A

Eixo Traseiro / Eje Trasero / Rear Axle

Roda / Rueda / Wheel			1.6 * 1.9L	F 15043	1689810327	TRBDR
----------------------	--	--	------------	---------	------------	-------

MB 180

Câmbio / Caja de Cambios / Gearbox

			4.5 * 4.2L	F 18021	6316810525	BBS
--	--	--	------------	---------	------------	-----

Diferencial / Diferencial / Differential

Coroa (dir./esq.) / Corona (der./izq.) / Crown Gear (right/left)				32010 XF	6319800002	TRB
--	--	--	--	----------	------------	-----

Eixo Dianteiro / Eje Delantero / Front Axle

Roda / Rueda / Wheel		•		LM 503349A / LM 503310	0089815905	TRB
	•			32009 XF	6319800102	TRB

Eixo Traseiro / Eje Trasero / Rear Axle

Roda / Rueda / Wheel		•		LM 503349A / LM 503310	0089815905	TRB
	•			32206 F	0019816505	TRB

Motor / Motor / Engine

Alternador - coletor / Alternador - colector / Alternator - manifold			Bosch	6201 2RS / C3	0049813521	BB
Alternador - polia / Alternador - polea / Alternator - pulley			Bosch	6303 2RS / C3	0049813625	BB

Sprinter 313 * 413

Diferencial / Diferencial / Differential

Caixa satélite / Caja satélite / Satellit box				LM 806649 / LM 806610		
Corpo Pinhão ext. / Piñón externo / Outer pinion			HLO * 15C-22	HM 803146 / HM 803110	0059812405	TRB
Corpo Pinhão int. / Piñón Interno / Inner pinion				M 88043 / M 88010	0079814105	TRB

Eixo Dianteiro / Eje Delantero / Front Axle

Roda / Rueda / Wheel		•	Dana	LM 501349 / LM 501310	6889817005	TRB
			Dana	33205 F	0039812205	TRB
				KA 273		KIT
			2.1L * 07...	LM 501349 / LM 501310		TRB
		•	2.1L * 07...	33205 F		TRB

Sprinter 316

Eixo Dianteiro / Eje Delantero / Front Axle

Roda / Rueda / Wheel	•		2.7L * 04...06	LM 501349 / LM 501310		TRB
		•	2.7L * 04...06	33205 F		TRB

Sprinter 415

Eixo Dianteiro / Eje Delantero / Front Axle

Roda / Rueda / Wheel	•		2.1L * 07...	LM 501349 / LM 501310		TRB
		•	2.1L * 07...	33205 F		TRB

Eixo Traseiro / Eje Trasero / Rear Axle

Roda / Rueda / Wheel	•		2.1L * 07...	32011 XF		TRB
		•	2.1L * 07...	32210 F		TRB

Sprinter 416

Eixo Dianteiro / Eje Delantero / Front Axle

Roda / Rueda / Wheel	•		2.7L * 04...06	LM 501349 / LM 501310		TRB
		•	2.7L * 04...06	33205 F		TRB

	OUT	IN		Fersa [®]	N° OEM	
---	-----	----	---	---------------------------	--------	---

MITSUBISHI

L 200

Eixo Dianteiro / Eje Delantero / Front Axle

Roda / Rueda / Wheel		●		LM 48548 / LM 48510	MB109564	TRB
	●			M 12649 / M 12610	MB109565	TRB

Eixo Traseiro / Eje Trasero / Rear Axle

Roda / Rueda / Wheel	●	●	1.6L * 81...90	30208 F	MB092432	TRB
	●	●	2.0L * 89...90	30208 F	MB092432	TRB
	●	●	2.5L	30208 F	MB092432	TRB
	●	●	2.0L * 83...90	30208 F	MB092432	TRB
	●	●	2.0L * 81...82	30208 F	MB092432	TRB
	●	●	2.0L * 82...85	30208 F	MB092432	TRB
	●	●	2.3L * 83...86	30208 F	MB092432	TRB
	●	●	2.3L * 83...86	30208 F	MB092432	TRB

L 300

Eixo Dianteiro / Eje Delantero / Front Axle

Roda / Rueda / Wheel		●		LM 48548 / LM 48510	MB109564	TRB
	●			M 12649 / M 12610	MB109565	TRB

Eixo Traseiro / Eje Trasero / Rear Axle

Roda / Rueda / Wheel	●	●	1.8L * 83...84	30208 F	MB092432	TRB
	●	●	2.0L	30208 F	MB092432	TRB

Montero * Pajero

Eixo Traseiro / Eje Trasero / Rear Axle

Roda / Rueda / Wheel	●	●	2.6L * 82...90	30208 F	MB092432	TRB
	●	●	2.3L * 82...86	30208 F	MB092432	TRB
	●	●	2.5L * 87...90	30208 F	MB092432	TRB
	●	●	2.6L * 84...90	30208 F	MB092432	TRB
	●	●	2.3L	30208 F	MB092432	TRB
	●	●	3.0L * 89...91	30208 F	MB092432	TRB
	●	●		30208 F	MB092432	TRB

Pajero I (2.5 * 2.8 * 3.0 * 3.5)

Diferencial / Diferencial / Differential

Pinhão cônico (dianteiro/traseiro) / Piñón cónico (delantero/trasero) / Bevel gear (front/rear)				HM 89449 / HM 89410		TRB
---	--	--	--	--------------------------------	--	-----



	OUT	IN		Fersa®	N° OEM	
---	-----	----	---	---------------	--------	---

NISSAN

Altima

Eixo Traseiro / Eje Trasero / Rear Axle

Roda / Rueda / Wheel				F 16081		BBDRAC
				F 16196		BBDRAC

Aprio

Eixo Traseiro / Eje Trasero / Rear Axle

Roda / Rueda / Wheel			1.6L * 08...09	F 15041		TRBDR
----------------------	--	--	----------------	----------------	--	-------

D21

Eixo Dianteiro / Eje Delantero / Front Axle

Roda / Rueda / Wheel	•		1.8L * 88...92	LM 48548 / LM 48510		TRB
		•	1.8L * 88...92	M 12649 / M 12610		TRB
	•		2.4L * 91...00	LM 48548 / LM 48510		TRB
		•	2.4L * 91...00	M 12649 / M 12610		TRB
	•		2.4L * 01...07	LM 48548 / LM 48510		TRB
		•	2.4L * 01...07	LM 300849 / LM 300811		TRB

Eixo Traseiro / Eje Trasero / Rear Axle

Roda / Rueda / Wheel			1.8L * 88...92	U 298 / U 261 L		U Series
			2.4L * 91...00	U 497 / U 460 L		U Series
			2.4L * 01...07	U 497 / U 460 L		U Series

Datsun

Eixo Dianteiro / Eje Delantero / Front Axle

Roda / Rueda / Wheel	•		1.6L * 80...84	L 44649 / L 44610		TRB
		•	1.6L * 80...84	LM 11749 / LM 11710		TRB
	•		1.8L * 83...84	L 44649 / L 44610		TRB
		•	1.8L * 83...84	LM 11749 / LM 11710		TRB

Frontier

Eixo Dianteiro / Eje Delantero / Front Axle

Roda / Rueda / Wheel		•		LM 603049 / LM 603011	40210-50W10	TRB
	•			LM 48548 / LM 48510	40210-F1700	TRB
	•		2.4L * 01...04	LM 48548 / LM 48510		TRB
		•	2.4L * 01...04	M 12649 / M 12610		TRB
	•		3.3L * 01...04	LM 603049 / LM 603011		TRB
		•	3.3L * 01...04	LM 300849 / LM 300811		TRB

Eixo Traseiro / Eje Trasero / Rear Axle

Roda / Rueda / Wheel		•		30208 F	40210-85000	TRB
	•			30208 F	40210-85000	TRB
			4.0L * 05...09	U 399 / U 360 L		U Series
			4.0L * 05...09	U 399 / U 360 L		U Series

Hikari

Eixo Dianteiro / Eje Delantero / Front Axle

Roda / Rueda / Wheel			1.6L * 88...92	F 16058		BBDRAC
----------------------	--	--	----------------	----------------	--	--------

Ichivan

Eixo Dianteiro / Eje Delantero / Front Axle

Roda / Rueda / Wheel	•		1.8L * 87...91	LM 67048 / LM 67010		TRB
----------------------	---	--	----------------	----------------------------	--	-----

	OUT	IN		Fersa [®]	N° OEM	
---	-----	----	---	---------------------------	--------	---

NISSAN

Ichivan

Roda / Rueda / Wheel		•	1.8L * 87...91	LM 11949 / LM 11910		TRB
	•		2.4L * 92...94	LM 67048 / LM 67010		TRB
		•	2.4L * 92...94	LM 11949 / LM 11910		TRB

Eixo Traseiro / Eje Trasero / Rear Axle

Roda / Rueda / Wheel			1.8L * 87...91	U 298 / U 261 L		U Series
			2.4L * 92...94	U 298 / U 261 L		U Series

Lucino

Eixo Dianteiro / Eje Delantero / Front Axle

Roda / Rueda / Wheel			1.6L * 96...00	F 16034		BBDRAC
			2.0L * 96...00	F 16034		BBDRAC

Maxima

Eixo Traseiro / Eje Trasero / Rear Axle

Roda / Rueda / Wheel				F 16081		BBDRAC
				F 16196		BBDRAC

Micra

Eixo Traseiro / Eje Trasero / Rear Axle

Roda / Rueda / Wheel			1.4L * 05...07	F 15041		TRBDR
----------------------	--	--	----------------	----------------	--	--------------

Pathfinder

Eixo Dianteiro / Eje Delantero / Front Axle

Roda / Rueda / Wheel		•		LM 603049 / LM 603011	40210-50W10	TRB
	•			LM 300849 / LM 300811	40215-D0100	TRB
	•		3.3L * 97...99	LM 603049 / LM 603011		TRB
		•	3.3L * 97...99	LM 300849 / LM 300811		TRB
	•		3.5L * 01...04	LM 603049 / LM 603011		TRB
		•	3.5L * 01...04	LM 300849 / LM 300811		TRB

Eixo Traseiro / Eje Trasero / Rear Axle

Roda / Rueda / Wheel		•		30208 F	40210-85000	TRB
	•			30208 F	40210-85000	TRB

Pick Up 2200

Eixo Dianteiro / Eje Delantero / Front Axle

Roda / Rueda / Wheel	•			LM 300849 / LM 300811	40215-D0100	TRB
		•		LM 300849 / LM 300811	40215-50W10	TRB
		•		LM 603049 / LM 603011	40210-50W10	TRB

Eixo Traseiro / Eje Trasero / Rear Axle

Roda / Rueda / Wheel	•	•		30208 F	40210-85000	TRB
----------------------	---	---	--	----------------	-------------	-----

Pick Up 2500

Eixo Dianteiro / Eje Delantero / Front Axle

Roda / Rueda / Wheel		•		LM 300849 / LM 300811	40215-D0100	TRB
		•		LM 603049 / LM 603011	40210-50W10	TRB

Eixo Traseiro / Eje Trasero / Rear Axle

Roda / Rueda / Wheel	•	•		30208 F	40210-85000	TRB
----------------------	---	---	--	----------------	-------------	-----

	OUT	IN		Fersa®	N° OEM	
NISSAN						
Pick Up 2700 4 x 4						
Eixo Dianteiro / Eje Delantero / Front Axle						
Roda / Rueda / Wheel		•		LM 300849 / LM 300811	40215-D0100	TRB
		•		LM 603049 / LM 603011	40210-50W10	TRB
Eixo Traseiro / Eje Trasero / Rear Axle						
Roda / Rueda / Wheel		•		30208 F	40210-85000	TRB
	•			30208 F	40210-85000	TRB
Platina						
Eixo Traseiro / Eje Trasero / Rear Axle						
Roda / Rueda / Wheel			1.6L * 02...	F 15041		TRBDR
Quest						
Eixo Dianteiro / Eje Delantero / Front Axle						
Roda / Rueda / Wheel			1.6L * 02...	F 16199		BBDRAC
Samurai						
Eixo Dianteiro / Eje Delantero / Front Axle						
Roda / Rueda / Wheel	•		1.6L * 85...87	LM 29749 / LM 29710		TRB
		•	1.6L * 85...87	LM 29749 / LM 29710		TRB
Eixo Traseiro / Eje Trasero / Rear Axle						
Roda / Rueda / Wheel	•		1.6L * 85...87	L 45449 / L 45410		TRB
		•	1.6L * 85...87	LM 11949 / LM 11910		TRB
Sentra						
Eixo Dianteiro / Eje Delantero / Front Axle						
Roda / Rueda / Wheel			1.6L * 96...00	F 16034		BBDRAC
			2.0L * 96...00	F 16034		BBDRAC
Terrano						
Eixo Dianteiro / Eje Delantero / Front Axle						
Roda / Rueda / Wheel		•		LM 603049 / LM 603011	40210-50W10	TRB
	•			LM 300849 / LM 300811	40215-D0100	TRB
Eixo Traseiro / Eje Trasero / Rear Axle						
Roda / Rueda / Wheel		•		30208 F	40210-85000	TRB
	•			30208 F	40210-85000	TRB
Titan						
Eixo Traseiro / Eje Trasero / Rear Axle						
Roda / Rueda / Wheel			5.6L * 04...09	U 399 / U 360 L		U Series
Tsubame						
Eixo Dianteiro / Eje Delantero / Front Axle						
Roda / Rueda / Wheel			1.6L * 93...03	F 16034		BBDRAC
Eixo Dianteiro / Eje Delantero / Front Axle						
Roda / Rueda / Wheel	•		1.5L * 84...87	LM 29749 / LM 29710		TRB
		•	1.5L * 84...87	LM 29749 / LM 29710		TRB
Eixo Traseiro / Eje Trasero / Rear Axle						
Roda / Rueda / Wheel	•		1.5L * 84...87	L 45449 / L 45410		TRB

	OUT	IN		Fersa [®]	N° OEM	
---	-----	----	---	---------------------------	--------	---

NISSAN

Tsuru I

Eixo Dianteiro / Eje Delantero / Front Axle

Roda / Rueda / Wheel		●	1.5L * 84...87	LM 11949 / LM 11910		TRB
----------------------	--	---	----------------	------------------------	--	-----

Tsuru II

Eixo Dianteiro / Eje Delantero / Front Axle

Roda / Rueda / Wheel			1.6L * 88...91	F 16058		BBDRAC
----------------------	--	--	----------------	---------	--	--------

Tsuru III

Eixo Dianteiro / Eje Delantero / Front Axle

Roda / Rueda / Wheel			1.6L * 92...	F 16034		BBDRAC
			2.0L * 95...96	F 16034		BBDRAC

Eixo Traseiro / Eje Trasero / Rear Axle

Roda / Rueda / Wheel				F 15151		TRBDR
----------------------	--	--	--	---------	--	-------

X-Terra

Eixo Dianteiro / Eje Delantero / Front Axle

Roda / Rueda / Wheel		●		LM 603049 / LM 603011	40210-50W10	TRB
		●		LM 48548 / LM 48510	40210-F1700	TRB
		●		2.4L * 00...04	LM 603049 / LM 603011	TRB
		●		2.4L * 00...04	LM 300849 / LM 300811	TRB
		●		3.3L * 00...04	LM 603049 / LM 603011	TRB
		●		3.3L * 00...04	LM 300849 / LM 300811	TRB

Eixo Traseiro / Eje Trasero / Rear Axle

Roda / Rueda / Wheel		●		30208 F	40210-85000	TRB
		●		30208 F	40210-85000	TRB
				4.0L * 05...07	U 399 / U 360 L	U Series



		OUT	IN		Fersa®	Nº OEM	
PEUGEOT							
205							
Câmbio / Caja de Cambios / Gearbox							
Eixo primário (traseiro) / Eje primario (traseiro) / Primary shaft (rear)					6205		BB
Eixo Dianteiro / Eje Delantero / Front Axle							
Roda / Rueda / Wheel			sim/sin/without ABS		F 16026	3350.17 / 332631	BBDRAC
Transmissão / Transmisión / Transmision					6006 RS / C3		BB
Eixo Traseiro / Eje Trasero / Rear Axle							
Roda / Rueda / Wheel			sim/sin/without ABS		F 15041	373021	TRBDR
Motor / Motor / Engine							
Alternador (dianteiro) / Alternador (delantero) / Alternator (front)			Bosch Mitsubishi		6201 2RS / C3		BB
206							
Eixo Dianteiro / Eje Delantero / Front Axle							
Roda / Rueda / Wheel			1.0 * 1.4 * 1.6L * sim/sin/without ABS * ROD F 16029		KF 145	335032	KIT
			1.6L * 01...09		F 16057		BBDRAC
Eixo Traseiro / Eje Trasero / Rear Axle							
Roda / Rueda / Wheel			1.4L * 00...09		F 15041		TRBDR
			1.6L * 01...09		F 15041		TRBDR
207							
Eixo Dianteiro / Eje Delantero / Front Axle							
Roda / Rueda / Wheel			1.4L * 09...		F 16057		BBDRAC
			1.6L * 07...		F 16057		BBDRAC
306							
Eixo Dianteiro / Eje Delantero / Front Axle							
Roda / Rueda / Wheel			sim/sin/without ABS		F 16026		BBDRAC
			1.6L * 1997		F 16057		BBDRAC
Transmissão / Transmisión / Transmision					6006 2RS / C3		BB
Eixo Traseiro / Eje Trasero / Rear Axle							
Roda / Rueda / Wheel			sim/sin/without ABS		F 15041	373021	TRBDR
			1.6L * 1997		F 15041		TRBDR
			1.8L * 98...02		F 15041		TRBDR
405							
Eixo Dianteiro / Eje Delantero / Front Axle							
Roda / Rueda / Wheel			2.0L * 97-99		F 16057		BBDRAC
406							
Eixo Dianteiro / Eje Delantero / Front Axle							
Roda / Rueda / Wheel			2.0L * 00...04		F 16057		BBDRAC
			2.9L * 01...04		F 16057		BBDRAC
			3.0L * 00...02		F 16057		BBDRAC
Grand Raid							
Eixo Dianteiro / Eje Delantero / Front Axle							
Roda / Rueda / Wheel			1.6L * 08...		F 16057		BBDRAC
Partner							
Eixo Dianteiro / Eje Delantero / Front Axle							
Roda / Rueda / Wheel			1.6L * 03...		F 16057		BBDRAC
			1.6L * 09...		F 16057		BBDRAC

	OUT	IN		Fersa®	Nº OEM	
RENAULT						
Clio						
Eixo Dianteiro / Eje Delantero / Front Axle						
Roda / Rueda / Wheel			1.0 * 1.6L * 8 * 16V	F 16013	7701205779 / 7701464049	BBDRAC
Eixo Traseiro / Eje Trasero / Rear Axle						
Roda / Rueda / Wheel			1.6L * 02...09	F 15041		TRBDR
Kangoo						
Eixo Dianteiro / Eje Delantero / Front Axle						
Roda / Rueda / Wheel			1.0 * 1.6L	F 16013	7701205779 / 7701464049	BBDRAC
Laguna						
Eixo Dianteiro / Eje Delantero / Front Axle						
Roda / Rueda / Wheel			2.0L - 8V * 3.0L - 24V V6	F 16013	7701205779 / 7701464049	BBDRAC
Laguna (2.0)						
Embreagem / Embrague / Clutch						
Apoio / Apoyo / Support				6203 2RS / C3		BB
Megane						
Eixo Traseiro / Eje Trasero / Rear Axle						
Roda / Rueda / Wheel			2.0L * 04...	F 15175		TRBDR
Eixo Dianteiro / Eje Delantero / Front Axle						
Roda / Rueda / Wheel			1.6 * 2.0L	F 16013	7701205779 / 7701464049	BBDRAC
R 21						
Eixo Dianteiro / Eje Delantero / Front Axle						
Roda / Rueda / Wheel			1.6 * 1.8L	F 16013	7701205779 / 7701464049	BBDRAC
R 23						
Motor / Motor / Engine						
Alternador (dianteiro) / Alternador (delantero) / Alternator (front)			except 2.1D	6203 2RS / C3		BB
R 24						
Motor / Motor / Engine						
Alternador (traseiro) / Alternador (trasero) / Alternator (rear)			except 2.1D	6202 2RS / C3		BB
Scénic						
Eixo Dianteiro / Eje Delantero / Front Axle						
Roda / Rueda / Wheel			1.6L - 16V * 2.0L - 8V * 2.0L - 16V	F 16013	7701205779 / 7701464049	BBDRAC
Traffic (2.1 * 2.2 * 2.5)						
Câmbio / Caja de Cambios / Gearbox						
Eixo secund. (dianteiro) / Eje secundario (delantero) / Secondary shaft (front)				NU 2205 F		CRB
Diferencial / Diferencial / Differential						
Caixa satélite / Caja satélite / Satellit box				6006 2RS		BB
Coroa lateral (dir./esq.) / Lateral corona (der./izq.) / Crown gear (right/left)				32009 XF		TRB
Eixo Traseiro / Eje Trasero / Rear Axle						
Semi Eixo / Semi eje / Front shaft				6006 2RS		BB

	OUT	IN		Fersa [®]	N° OEM	
---	-----	----	---	---------------------------	--------	---

SEAT

Cordoba

Câmbio / Caja de Cambios / Gearbox

Eixo piloto (dianteiro) / Eje piloto (delantero) / Pilot shaft (front)			95...03	F 18024	020311123N	BBS
--	--	--	---------	----------------	------------	-----

Eixo Dianteiro / Eje Delantero / Front Axle

Roda / Rueda / Wheel			93...	F 16039	357498625	BBDRAC
----------------------	--	--	-------	----------------	-----------	--------

Eixo Traseiro / Eje Trasero / Rear Axle

Roda / Rueda / Wheel		•	93...	L 45449 / L 45410	191598625	TRB
	•		93...	LM 11749 / LM 11710	311405645	TRB

Ibiza

Câmbio / Caja de Cambios / Gearbox

Eixo piloto (dianteiro) / Eje piloto (delantero) / Pilot shaft (front)			95...03	F 18024	020311123N	BBS
--	--	--	---------	----------------	------------	-----

Eixo Dianteiro / Eje Delantero / Front Axle

Roda / Rueda / Wheel				F 16039	357498625	BBDRAC
			1.6L * 01...02	F 16039		BBDRAC

Eixo Traseiro / Eje Trasero / Rear Axle

Roda / Rueda / Wheel		•		L 45449 / L 45410	191598625	TRB
	•			LM 11749 / LM 11710	311405645	TRB

Inca

Câmbio / Caja de Cambios / Gearbox

Eixo piloto (dianteiro) / Eje piloto (delantero) / Pilot shaft (front)			95...03	F 18024	020311123N	BBS
--	--	--	---------	----------------	------------	-----

Eixo Dianteiro / Eje Delantero / Front Axle

Roda / Rueda / Wheel				F 16039	357498625	BBDRAC
----------------------	--	--	--	----------------	-----------	--------

Toledo

Eixo Dianteiro / Eje Delantero / Front Axle

Roda / Rueda / Wheel			91...	F 16039	357498625	BBDRAC
----------------------	--	--	-------	----------------	-----------	--------

Eixo Traseiro / Eje Trasero / Rear Axle

Roda / Rueda / Wheel		•	91...	L 45449 / L 45410	191598625	TRB
	•		91...	LM 11749 / LM 11710	311405645	TRB

Toledo II

Eixo Dianteiro / Eje Delantero / Front Axle

Roda / Rueda / Wheel			PQ 34	F 16040	1J0407625	BBDRAC
----------------------	--	--	-------	----------------	-----------	--------

SKODA

Octavia

Eixo Dianteiro / Eje Delantero / Front Axle

Roda / Rueda / Wheel				F 16040	1J0407625	BBDRAC
----------------------	--	--	--	----------------	-----------	--------



OUT IN



Fersa®

N° OEM



TOYOTA

Bandeirante

Caixa de Transferência / Caja de Transferencia / Transfer Case

Eixo de entrada / Eje de entrada / Input shaft			...81	6306 ZZ	9002363006	BB
Eixo de tração (dianteiro) / Eje de tracción (delantero) / Driven axle (front)			81...	6306 ZZ	9002363006	BB
Eixo entalhado (dianteiro/traseiro) / Eje entallado (delantero/traseiro) / Notched shaft (front/rear)			81...	30307 F	9760030307	TRB
			...81	6307 Z	9002363007	BB
			81...	30307 F		TRB
			...81	6307 Z		BB
Eixo intermediário (dianteiro) / Eje Intermediario (delantero) / Intermediate shaft (front)			...81	6306 ZZ	9002363006	BB
			...81	6306 ZZ		BB
Eixo intermediário (traseiro) / Eje Intermediario (traseiro) / Intermediate shaft (rear)			...81	6306 ZZ	9002363006	BB

Câmbio / Caja de Cambios / Gearbox

			...81	6209 NR / C3	9002363010	BB
			81...	6308 NR / C3	9715406308	BB
			...81	6307 Z	7002363007	BB
			81...	6308 NR / C3	9715406308	BB
Eixo primário (dianteiro) / Eje primario (delantero) / Primary shaft (front)			...81	6209 NR / C3		BB
Eixo primário (traseiro) / Eje primario (traseiro) / Primary shaft (rear)			...81	6307 Z		BB

Diferencial / Diferencial / Differential

Dianteiro - Pinhão cônico (dianteiro) / Delantero - Piñón cónico (delantero) / Front - Bevel gear (front)				31308 F		TRB
Dianteiro - Pinhão cônico (traseiro) / Delantero - Piñón cónico (traseiro) / Front - Bevel gear (rear)			67...	31308 F		TRB
Pinhão dianteiro / Piñón delantero / Front pinion			67...	30206 F	9760030206KB4053	TRB
			67...	30306 F	9002366002	TRB
Pinhão dianteiro - eixo dianteiro / Piñón delantero - eje delantero / Front pinion - front axle				31308 F	9002366003	TRB
Pinhão traseiro / Piñón trasero / Rear Pinion				31308 F	9002366003	TRB
Pinhão traseiro - eixo dianteiro / Piñón trasero - eje delantero / Rear pinion front axle			67...	30306 F	9002366002	TRB

Eixo Dianteiro / Eje Delantero / Front Axle

Roda / Rueda / Wheel				JLM 104948/10	9002368014 / 903684084	TRB
----------------------	--	--	--	----------------------	------------------------	-----

Eixo Traseiro / Eje Trasero / Rear Axle

Roda / Rueda / Wheel				JLM 104948/10	9002368014 / 903684084	TRB
----------------------	--	--	--	----------------------	------------------------	-----

Embreagem / Embrague / Clutch

Apoio / Apoyo / Support				6202 ZZ	9002363001	BB
				6202 ZZ		BB

Motor / Motor / Engine

Alternador - coletor / Alternador - colector / Alternator - manifold			Bosch	6200 2RS / C3		BB
Alternador (dianteiro) / Alternador (delantero) / Alternator (front)			Bosch	6200 2RS / C3		BB
			Bosch * Wapsa	6203 2RS / C3		BB
Alternador - polia / Alternador - polea / Alternator - pulley			Bosch * Wapsa	6203 2RS / C3		BB

	OUT	IN		Fersa®	N° OEM	
---	-----	----	---	---------------	--------	---

TOYOTA

Bandeirante

Bomba d'água / Bomba de agua / Water pump				6206 ZZ	000625006206	BB
Bomba d'água (traseiro) / Bomba de agua (traseiro) / Water pump (rear)				6203 2RS / C3	000625006203	BB
Bomba injetora (dianteiro) / Bomba inyectora (delantero) / Jet pump (front)				6203		BB
Dinamo / Dinamo / Dynamo			Wapsa	6202 2RS		BB
Dinamo (dianteiro/traseiro) / Dinamo (delantero/traseiro) / Dynamo (front/rear)			Wapsa	6202 2RS / C3		BB

Tomada de Força / Toma de Fuerza / Toma de Fuerza

Eixo entalhado (dir.) / Eje entallado (der.) / Notched shaft (right)			...81	31308 F		TRB
Eixo entalhado (esq.) / Eje entallado (izq.) / Notched shaft (left)			...81	6205 ZZ		BB
Tomada de Força / Toma de fuerza / Toma de fuerza						
Tomada de Força / Toma de fuerza / Toma de fuerza			...81	6203 ZZ	9002363002	BB
			...81	31308 F	9002363003	TRB
			...81	6205 ZZ	9002363005	BB

Hilux

Eixo Dianteiro / Eje Delantero / Front Axle

Roda / Rueda / Wheel		●	1.6 * 1.8 * 2.0 * 2.2 * 2.4L	LM 48548 / LM 48510	90368-34001	TRB
		●	1.6 * 1.8 * 2.0 * 2.2 * 2.4L	M 12649 / M 12610	90368-21001	TRB
		●		JLM 104948 / 10	9002368014 / 903684084	TRB

Eixo Traseiro / Eje Trasero / Rear Axle

Roda / Rueda / Wheel		●		JLM 104948 / 10	9002368014 / 903684084	TRB
----------------------	--	---	--	------------------------	------------------------	-----

Land Cruiser

Eixo Traseiro / Eje Trasero / Rear Axle



Roda / Rueda / Wheel		●		JLM 104948 / 10	9002368014 / 903684084	TRB
----------------------	--	---	--	------------------------	------------------------	-----

RAV4

Eixo Dianteiro / Eje Delantero / Front Axle

Roda / Rueda / Wheel				F 16078		BBDRAC
----------------------	--	--	--	----------------	--	--------



	OUT	IN		Fersa [®]	N° OEM	
---	-----	----	---	---------------------------	--------	---

VOLKSWAGEN

1600 * 1600TL

Eixo Dianteiro / Eje Delantero / Front Axle

Roda / Rueda / Wheel		•		L 45449 / L 45410	3114056251	TRB
		•	...69	L 44649 / L 44610	311405625	TRB
	•			LM 11749 / LM 11710	3114056451	TRB

Eixo Traseiro / Eje Trasero / Rear Axle

Roda / Rueda / Wheel				6306 C3	1135012834	BB
----------------------	--	--	--	---------	------------	----

Apollo

Câmbio / Caja de Cambios / Gearbox

Eixo piloto (dianteiro) / Eje piloto (delantero) / Pilot shaft (front)			90...92	F 18024	020311123N	BBS
Eixo secund. (dianteiro) / Eje secundario (delantero) / Secondary shaft (front)				L 45449 / L 45410		TRB
Eixo secundário - intermediário / Eje secundario - intermediario / Secondary shaft - intermediate			1.8L	LM 78349 / LM 78310 A	020311206	TRB
Lateral coroa (dir./esq.) / Lateral corona (der./izq.) / Crown gear (right/left)			1.8L	LM 29749 / LM 29710	003519185B	TRB

Diferencial / Diferencial / Differential

Coroa lateral - (dir./esq.) / Lateral corona - (der./izq.) / Crown gear (right/left)				LM 29749 / LM 29710		TRB
--	--	--	--	---------------------	--	-----

Eixo Dianteiro / Eje Delantero / Front Axle

Roda / Rueda / Wheel				KA 019		KIT
----------------------	--	--	--	--------	--	-----

Eixo Traseiro / Eje Trasero / Rear Axle

Roda / Rueda / Wheel	•	•		F 15036	81AB1215AB	TRBS
				KA 075		KIT
		•	1.8L	L 45449 / L 45410	3114056451	TRB
	•		1.8L	LM 11749 / LM 11710	3114056451	TRB

Motor / Motor / Engine

Alternador (dianteiro) / Alternador (delantero) / Alternator (front)				6203 2RS / C3		BB
Alternador - lado coletor / Alternador - lado colector / Alternator - manifold			1.8L	6201 2RS / C3	0299032212	BB
Alternador (traseiro) / Alternador (trasero) / Alternator (rear)				6201 2RS / C3		BB

Atlantic

Eixo Dianteiro / Eje Delantero / Front Axle

Roda / Rueda / Wheel			1.7L * 81...87	F 16019		BBDRAC
Eixo Traseiro / Eje Trasero / Rear Axle			1.8L * 84...87	F 16019		BBDRAC
Roda / Rueda / Wheel	•		1.7L * 81...87	L 45449 / L 45410		TRB
		•	1.7L * 81...87	LM 11749 / LM 11710		TRB
	•		1.8L * 84...87	L 45449 / L 45410		TRB
		•	1.8L * 84...87	LM 11749 / LM 11710		TRB

Bora

Eixo Dianteiro / Eje Delantero / Front Axle

Roda / Rueda / Wheel			PQ 34	F 16040	1J0407625	BBDRAC
----------------------	--	--	-------	---------	-----------	--------

Motor / Motor / Engine

Alternador - lado polia / Alternador - lado polea / Alternator - pulley			1.8L	6203 2RS / C3	80227	BB
---	--	--	------	---------------	-------	----

	OUT	IN		Fersa [®]	N° OEM	
---	-----	----	---	---------------------------	--------	---

VOLKSWAGEN

Brasília

Eixo Dianteiro / Eje Delantero / Front Axle

Roda / Rueda / Wheel		•	1.6L	L 45449 / L 45410	3114056251	TRB
	•		1.6L	LM 11749 / LM 11710	3114056451	TRB

Eixo Traseiro / Eje Trasero / Rear Axle

Roda / Rueda / Wheel				6306 C3	1135012834	BB
----------------------	--	--	--	---------	------------	----

Motor / Motor / Engine

Alternador - lado coletor / Alternador - lado colector / Alternator - manifold				6202 2RS / C3	111903221Z	BB
Alternador - lado polia / Alternador - lado polea / Alternator - pulley				6203 2RS / C3	1029032211	BB

Brasília (1500 * 1600) * Fusca (1300 * 1300L* 1500 * 1600) * Variant I

Motor / Motor / Engine

Alternador (dianteiro) / Alternador (delantero) / Alternator (front)			Bosch	6203 2RS / C3		BB
Alternador (traseiro) / Alternador (trasero) / Alternator (rear)			Variant I Bosch	6201 2RS / C3		BB
Dinamo (dianteiro/traseiro) / Dinamo (delantero/trasero) / Dynamo (front/rear)			Bosch	6202 2RS / C3		BB
				6202 2RS / C3		BB

Cabrio

Eixo Dianteiro / Eje Delantero / Front Axle

Roda / Rueda / Wheel			2.0L * 96...02	F 16039		BBDRAC
----------------------	--	--	----------------	---------	--	--------

Eixo Traseiro / Eje Trasero / Rear Axle

Roda / Rueda / Wheel	•		2.0L * 96...02	L 45449 / L 45410		TRB
		•	2.0L * 96...02	LM 11749 / LM 11710		TRB

Caddy

Eixo Dianteiro / Eje Delantero / Front Axle

Roda / Rueda / Wheel				F 16039	357498625B	BBDRAC
----------------------	--	--	--	---------	------------	--------

Caribe

Eixo Dianteiro / Eje Delantero / Front Axle

Roda / Rueda / Wheel			1.7L * 81...85	F 16019		BBDRAC
			1.8L * 84...87	F 16019		BBDRAC



Eixo Traseiro / Eje Trasero / Rear Axle

Roda / Rueda / Wheel	•		1.7L * 81...85	L 45449 / L 45410		TRB
		•	1.7L * 81...85	LM 11749 / LM 11710		TRB
	•		1.8L * 84...87	L 45449 / L 45410		TRB
		•	1.8L * 84...87	LM 11749 / LM 11710		TRB

Combi

Eixo Dianteiro / Eje Delantero / Front Axle

Roda / Rueda / Wheel	•		1.6L * 78...87	LM 67048 / LM 67010		TRB
		•	1.6L * 78...87	LM 11949 / LM 11910		TRB
	•		1.8L * 80...01	LM 67048 / LM 67010		TRB
		•	1.8L * 80...01	LM 11949 / LM 11910		TRB

	OUT	IN		Fersa [®]	N° OEM	
---	-----	----	---	---------------------------	--------	---

VOLKSWAGEN

Corrado

Eixo Dianteiro / Eje Delantero / Front Axle

Roda / Rueda / Wheel			2.8L * 92...	F 16039	357498625	BBDRAC
----------------------	--	--	--------------	----------------	-----------	--------

Eixo Traseiro / Eje Trasero / Rear Axle

Roda / Rueda / Wheel		•	2.8L * 92...	L 45449 / L 45410	191598625	TRB
	•		2.8L * 92...	LM 11749 / LM 11710	311405645	TRB

Corsar

Eixo Traseiro / Eje Trasero / Rear Axle

Roda / Rueda / Wheel	•		1.8L * 84...88	L 45449 / L 45410		TRB
		•	1.8L * 84...88	LM 11749 / LM 11710		TRB

Crossfox

Eixo Dianteiro / Eje Delantero / Front Axle

Roda / Rueda / Wheel			1.6L * 07...	F 16036		BBDRAC
----------------------	--	--	--------------	----------------	--	--------

Derby

Eixo Dianteiro / Eje Delantero / Front Axle

Roda / Rueda / Wheel			1.8L * 94...01	F 16039		BBDRAC
			1.8L * 02...09	F 16039		BBDRAC
			2.0L * 02...03	F 16039		BBDRAC

Eixo Traseiro / Eje Trasero / Rear Axle

Roda / Rueda / Wheel	•		1.8L * 94...01	L 45449 / L 45410		TRB
		•	1.8L * 94...01	LM 11749 / LM 11710		TRB

Fusca

Eixo Dianteiro / Eje Delantero / Front Axle

Roda / Rueda / Wheel		•	1200 * 1300	30305 F	111405627	TRB
		•	1500 * 1600	L 45449 / L 45410	3114056251	TRB
		•	1200 * 1300	30304 F	111405647	TRB
		•	1500 * 1600	LM 11749 / LM 11710	3114056451	TRB

Eixo Traseiro / Eje Trasero / Rear Axle

Roda / Rueda / Wheel			1200 * 1300 * 1500 * 1600	6306 C3	1135012834	BB
----------------------	--	--	---------------------------	----------------	------------	----

Motor / Motor / Engine

Dínamo - polia / Dinamo - polea / Dynamo - pulley			Bosch 25A-2	6202 ZZ	111903221Z	BB
---	--	--	-------------	----------------	------------	----

Gol

Eixo Dianteiro / Eje Delantero / Front Axle

Roda / Rueda / Wheel			1.6L * 09...	F 16036		BBDRAC
			1.6L * 09...	F 16036		BBDRAC



Eixo Traseiro / Eje Trasero / Rear Axle

Roda / Rueda / Wheel	•		1.6L * 09...	L 45449 / L 45410		TRB
		•	1.6L * 09...	LM 11749 / LM 11710		TRB

Gol * Parati

Diferencial / Diferencial / Differential

Coroa lateral - (dir./esq.) / Lateral corona - (der./izq.) / Crown gear (right/left)				LM 300849 / LM 300811		TRB
--	--	--	--	------------------------------	--	-----

	OUT	IN		Fersa®	Nº OEM	
---	-----	----	---	---------------	--------	---

VOLKSWAGEN

Gol * Parati (AP 1.6 * 1.8 * 2.0)

Motor / Motor / Engine

Alternador (dianteiro) / Alternador (delantero) / Alternator (front)			Bosch * Wapsa 35 * 45 * 55 * 65 A	6203 2RS / C3		BB
Alternador (traseiro) / Alternador (trasero) / Alternator (rear)			65 * 70 * 75 * 90 1.6 Mi	6003 2RS / C3		BB
			Bosch * Wapsa 35 * 45 * 55 * 65 * 95 A	6201 2RS / C3		BB
			70 * 90 A 16V	6203 2RS / C3		BB

Gol * Parati (motor AT)

Motor / Motor / Engine

Alternador (dianteiro) / Alternador (delantero) / Alternator (front)			Bosch * Wapsa 35 * 45 * 55 * 65 A	6203 2RS / C3		BB
Alternador (traseiro) / Alternador (trasero) / Alternator (rear)			65 * 70 * 75 * 90 1.0 Mi 16V	6003 2RS / C3		BB
			Bosch * Wapsa 35 * 45 * 55 * 65 * 95 A	6201 2RS / C3		BB

Gol * Parati (motor CHT)

Motor / Motor / Engine

Alternador (dianteiro) / Alternador (delantero) / Alternator (front)						
Bosch * Wapsa (35 * 45 * 55 * 65 A)						
Alternador (traseiro) / Alternador (trasero) / Alternator (rear)			Bosch * Wapsa 35 * 45 * 55 * 65 * 95 A	6201 2RS / C3		BB

Gol (1.3 * 1.6)

Diferencial / Diferencial / Differential

Coroa lateral - (dir./esq.) / Lateral corona - (der./izq.) / Crown gear (right/left)				LM 300849 / LM 300811		TRB
--	--	--	--	------------------------------	--	-----

Motor / Motor / Engine

Alternador (dianteiro) / Alternador (delantero) / Alternator (front)			Bosch 35A-BP	6203 2RS / C3		BB
Alternador (traseiro) / Alternador (trasero) / Alternator (rear)			Bosch 35A-BP	6202 2RS / C3		BB
Dinamo / Dinamo / Dynamo			25A-2BP	6202 2RS / C3		BB
Dinamo (dianteiro) / Dinamo (delantero) / Dynamo (front)			Bosch 25A-2OU	6202 2RS / C3		BB
Dinamo (traseiro) / Dinamo (trasero) / Dynamo (rear)			Bosch 25A-2OU	6201 2RS / C3		BB

Gol * Parati * Voyage * Saveiro

Câmbio / Caja de Cambios / Gearbox

			...84	6304 2RS / C3	014311371C	BB
Lateral coroa (dir./esq.) / Lateral corona (der./izq.) / Crown gear (right/left)				LM 300849 / LM 300811	113517185B	TRB

Eixo Traseiro / Eje Trasero / Rear Axle

Roda / Rueda / Wheel				KA 069		KIT
		•		L 45449 / L 45410	3114056251	TRB
	•			LM 11749 / LM 11710	3114056251	TRB

Motor / Motor / Engine

Alternador - lado coletor / Alternador - lado colector / Alternator - manifold			1.6 * 1.8 * 2.0L	6201 2RS / C3	0299032212	BB
			1.3 * 1.6L * Bosch 35A-BP	6202 2RS / C3	111903221Z	BB
			1.3 * 1.6L * Bosch * Wapsa 25A-2BP	6202 2RS	111903221Z	BB

	OUT	IN		Fersa®	Nº OEM	
---	-----	----	---	---------------	--------	---

VOLKSWAGEN

Gol * Parati * Voyage * Saveiro

Alternador - lado polia / Alternador - lado polea / Alternator - pulley			1.3 * 1.6L * 1.8 * 2.0L * Bosch 35A-BP	6203 2RS / C3	80227	BB
Dínamo - lado coletor / Dinamo - lado de coletor / Dynamo - manifold			1.8 * 2.0L	6201 ZZ / C3	1059032211	BB
Dínamo - polia / Dinamo - polea / Dynamo - pulley			1.3 * 1.6L * 1.8 * 2.0L * Bosch 25A-2	6202 2RS	111903221Z	BB
			1.3 * 1.6L	6202 ZZ	111903221Z	BB

Golf

Câmbio / Caja de Cambios / Gearbox

Eixo piloto (dianteiro) / Eje piloto (delantero) / Pilot shaft (front)				F 18024	020311123N	BBS
--	--	--	--	----------------	------------	-----

Eixo Dianteiro / Eje Delantero / Front Axle

Roda / Rueda / Wheel			1.6 * 1.8 * 2.0L GTI	F 16039	357498625	BBDRAC
----------------------	--	--	----------------------	----------------	-----------	--------

Eixo Traseiro / Eje Trasero / Rear Axle

Roda / Rueda / Wheel				KA 069		KIT
		•	1.6 * 1.8 * 2.0L GTI	L 45449 / L 45410	191598625	TRB
		•	1.6 * 1.8 * 2.0L GTI	LM 11749 / LM 11710	311405645	TRB

Câmbio / Caja de Cambios / Gearbox

Eixo secund. (dianteiro) / Eje secundario (delantero) / Secondary shaft (front)			1.8 * 2.0e * 2.8	L 45449 / L 45410		TRB
---	--	--	------------------	--------------------------	--	-----

Golf A4

Câmbio / Caja de Cambios / Gearbox

Coroa lateral (dir./esq.) / Lateral corona (der./izq.) / Crown gear (right/left)			4e* 5	LM 300849 / LM 300811		TRB
--	--	--	-------	------------------------------	--	-----

Golf IV

Eixo Dianteiro / Eje Delantero / Front Axle

Roda / Rueda / Wheel				F 16040	1J0407625	BBDRAC
----------------------	--	--	--	----------------	-----------	--------

Eixo Traseiro / Eje Trasero / Rear Axle

Roda / Rueda / Wheel				F 16065	1J0501477A	BBDRAC
----------------------	--	--	--	----------------	------------	--------

Jetta

Eixo Dianteiro / Eje Delantero / Front Axle

Roda / Rueda / Wheel				F 16040	1J0407625	BBDRAC
			1.8L * 88...99	F 16039		BBDRAC
			2.0L * 93...99	F 16039		BBDRAC



Eixo Traseiro / Eje Trasero / Rear Axle

Roda / Rueda / Wheel				F 16065	1J0501477A	BBDRAC
	•		1.8L * 88...99	L 45449 / L 45410		TRB
		•	1.8L * 88...99	LM 11749 / LM 11710		TRB
	•		2.0L * 93...99	L 45449 / L 45410		TRB
		•	2.0L * 93...99	LM 11749 / LM 11710		TRB

Karmann Ghia

Eixo Dianteiro / Eje Delantero / Front Axle

Roda / Rueda / Wheel		•	1200	30305 F	111405627	TRB
----------------------	--	---	------	----------------	-----------	-----

	OUT	IN		Fersa®	Nº OEM	
VOLKSWAGEN						
Karmann Ghia						
Roda / Rueda / Wheel		•	1500	L 45449 / L 45410	3114056251	TRB
	•		1200	30304 F	111405647	TRB
	•		1500	LM 11749 / LM 11710	3114056451	TRB
Eixo Traseiro / Eje Trasero / Rear Axle						
Roda / Rueda / Wheel			1200 * 1500	6306 C3	1135012834	BB
Kombi						
Câmbio / Caja de Cambios / Gearbox						
Lateral coroa (dir./esq.) / Lateral corona (der./izq.) / Crown gear (right/left)			1600 Clipper * 75...	LM 300849 / LM 300811	113517185B	TRB
Eixo Dianteiro / Eje Delantero / Front Axle						
Roda / Rueda / Wheel		•	1200	30306 F	211405073	TRB
		•	1500 * 1600	LM 67048 / LM 67010	2114056251	TRB
	•		1200	30305 F	111405647	TRB
	•		1500 * 1600	LM 11949 / LM 11910	211405647	TRB
Eixo Traseiro / Eje Trasero / Rear Axle						
Roda / Rueda / Wheel			1200 * 1500 * 1600 * ...77	N 207 / C3	211501283	CRB
			1200 * 1500 * 1600 * ...77	6306 C3	1135012834	BB
			1200 * 1500 * 1600 * ...77	6305 C3	211501285	BB
			1200 * 1500 * 1600 * ...77	6306 C3	1135012834	BB
Motor / Motor / Engine						
Alternador - lado coletor / Alternador - lado colector / Alternador - manifold			1500 * 1600	6202 2RS / C3	111903221Z	BB
Alternador - polia / Alternador - polea / Alternador - pulley			1500 * 1600	6203 2RS / C3	1029032211	BB
Dinamo / Dinamo / Dynamo				6202 2RS	111903221Z	BB
Dinamo - lado coletor / Dinamo - lado de colector / Dynamo - manifold			1500 * 1600 * Bosch * Wapsa 25A-2BP	6201 ZZ / C3	1059032211	BB
Dinamo - polia / Dinamo - polea / Dynamo - pulley				6202 ZZ	111903221Z	BB
Kombi (1500 * 1600)						
Caixa de redução de veloc / Caja Reductora / Transfer case						
			78...	6305 C3		BB
			78...	6306 C3		BB
Diferencial / Diferencial / Differential						
Coroa lateral - (dir./esq.) / Lateral corona - (der./izq.) / Crown gear (right/left)			75...	LM 300849 / LM 300811		TRB
Eixo Traseiro / Eje Trasero / Rear Axle						
Ponta de Eixo (int.) / Punta de eje (interior) / Spindle (inner)			78...	6207 C3		BB
Motor / Motor / Engine						
Alternador (dianteiro) / Alternador (delantero) / Alternator (front)			Bosch 35A-BP	6203 2RS / C3		BB
Alternador (traseiro) / Alternador (trasero) / Alternator (rear)			Bosch 35A-BP	6202 2RS / C3		BB
Dinamo / Dinamo / Dynamo			Bosch * Wapsa 25A-BP	6202 2RS / C3		BB
Dinamo (dianteiro) / Dinamo (delantero) / Dynamo (front)			Bosch 25A-2OU	6202 2RS / C3		BB
Dinamo (traseiro) / Dinamo (trasero) / Dynamo (rear)			Bosch 25A-2OU	6201 2RS / C3		BB

	OUT	IN		Fersa [®]	N° OEM	
---	-----	----	---	---------------------------	--------	---

VOLKSWAGEN

Logus

Câmbio / Caja de Cambios / Gearbox

				LM 29749 / LM 29710	003519185	TRB
Eixo secundário - lado volante / Eje secundario - lado volante / Secondary shaft - steering wheel			1.6 * 1.8L	L 45449 / L 45410	311405625C	TRB
Lateral coroa (dir./esq.) / Lateral corona (der./izq.) / Crown gear (right/left)			1.6 * 1.8L	LM 300849 / LM 300811	113517185B	TRB

Eixo Traseiro / Eje Trasero / Rear Axle

Roda / Rueda / Wheel				KA 021	096FXIA049AB	KIT
----------------------	--	--	--	--------	--------------	-----

Motor / Motor / Engine

Alternador - lado coletor / Alternador - lado colector / Alternator - manifold			1.6 e 1.8L	6201 2RS / C3	0299032212	BB
Alternador - lado polia / Alternador - lado pulea / Alternator - pulley			1.6 e 1.8L	6303 2RS / C3	80227	BB

Logus (1.6 * 1.8)

Câmbio / Caja de Cambios / Gearbox

Eixo secund. (dir.) / Eje secundario (der.) / Secondary shaft (right)				L 45449 / L 45410		TRB
Eixo secund. (esq.) / Eje secundario (izq.) / Secondary shaft (left)				LM 29749 / LM 29710		TRB

Motor / Motor / Engine

Alternador (dianteiro) / Alternador (delantero) / Alternator (front)				6303 2RS / C3		BB
Alternador (traseiro) / Alternador (trasero) / Alternator (rear)				6201 2RS / C3		BB

Lupo

Eixo Dianteiro / Eje Delantero / Front Axle

Roda / Rueda / Wheel			1.6L * 05...	F 16036		BBDRAC
----------------------	--	--	--------------	---------	--	--------

New Beetle

Eixo Dianteiro / Eje Delantero / Front Axle

Roda / Rueda / Wheel			PQ 34	F 16040	1J0407625	BBDRAC
----------------------	--	--	-------	---------	-----------	--------

Eixo Traseiro / Eje Trasero / Rear Axle

Roda / Rueda / Wheel				F 16065	1J0501477A	BBDRAC
----------------------	--	--	--	---------	------------	--------

Panel

Eixo Dianteiro / Eje Delantero / Front Axle

Roda / Rueda / Wheel	•		1.6L * 78...87	LM 67048 / LM 67010		TRB
		•	1.6L * 78...87	LM 11949 / LM 11910		TRB
	•		1.8L * 95...01	LM 67048 / LM 67010		TRB
		•	1.8L * 95...01	LM 11949 / LM 11910		TRB



Passat



Câmbio / Caja de Cambios / Gearbox

			...84	6304 2RS / C3	014311371C	BB
Lateral coroa (dir./esq.) / Lateral corona (der./izq.) / Crown gear (right/left)				LM 300849 / LM 300811	113517185B	TRB

Eixo Dianteiro / Eje Delantero / Front Axle

Roda / Rueda / Wheel			1.8L T * 99...05	F 16054		BBDRAC
----------------------	--	--	------------------	---------	--	--------

	OUT	IN		Fersa®	Nº OEM	
VOLKSWAGEN						
Passat						
Roda / Rueda / Wheel			2.0L * 91 -93	F 16039		BBDRAC
			2.8L * 96...05	F 16054		BBDRAC
			2.8L * 02...05	F 16054		BBDRAC
Eixo Traseiro / Eje Trasero / Rear Axle						
Roda / Rueda / Wheel				KA 069		KIT
	•		1.6 * 1.8L	L 45449 / L 45410	3114056451	TRB
	•		1.6 * 1.8L	LM 11749 / LM 11710	3114056451	TRB
	•		1.8L T * 99...05	L 45449 / L 45410		TRB
	•		1.8L T * 99...05	LM 11749 / LM 11710		TRB
	•		2.0L * 91 -93	L 45449 / L 45410		TRB
	•		2.0L * 91 -93	LM 11749 / LM 11710		TRB
			2.8L * 96...05	F 16038		BBDRAC
			2.8L * 02...05	F 16038		BBDRAC
Motor / Motor / Engine						
Alternador - lado coletor / Alternador - lado colector / Alternador - manifold			1.6 * 1.8L	6201 2RS / C3	0299032212	BB
Alternador - lado polia / Alternador - lado polea / Alternador - pulley			1.6 * 1.8L	6203 2RS / C3	80227	BB
Dinamo / Dinamo / Dynamo			1.6 * 1.8L	6202 2RS	111903221Z	BB
Dinamo - lado coletor / Dinamo - lado de colector / Dynamo - manifold			1.6 * 1.8L * Bosch 25A-2	6201 ZZ / C3	1059032211	BB
Dinamo - polia / Dinamo - polea / Dynamo - pulley			1.6 * 1.8L * Bosch 25A-2	6202 2RS	111903221Z	BB
Passat (1.5 * 1.6 * 1.8)						
Diferencial / Diferencial / Differential						
Coroa lateral - (dir./esq.) / Lateral corona - (der./izq.) / Crown gear (right/left)			... 84	LM 300849 / LM 300811		TRB
Direção / Dirección / Steering						
Pinhão cônico (traseiro) / Piñón cónico (trasero) / Bevel gear (rear)				6001 C3		BB
Motor / Motor / Engine						
Alternador (dianteiro) / Alternador (delantero) / Alternator (front)			Bosch * Wapsa 35 * 45 * 55 * 65 A	6203 2RS / C3		BB
Alternador (traseiro) / Alternador (trasero) / Alternator (rear)			65 * 70 * 75 * 90 * 1.6 Mi	6003 2RS / C3		BB
			Bosch * Wapsa 35 * 45 * 55 * 65 * 95 A	6201 2RS / C3		BB
Passat 2.8 VR10						
Eixo Traseiro / Eje Trasero / Rear Axle						
Roda / Rueda / Wheel		•	98...99	L 45449 / L 45410	191598625	TRB
	•		98...99	LM 11749 / LM 11710	311405645	TRB
Eixo Dianteiro / Eje Delantero / Front Axle						
Roda / Rueda / Wheel			98...99	F 16039	357498625	BBDRAC
Pointer						
Câmbio / Caja de Cambios / Gearbox						
				LM 29749 / LM 29710	003519185	TRB

	OUT	IN		Fersa [®]	N° OEM	
---	-----	----	---	---------------------------	--------	---

VOLKSWAGEN

Pointer

Eixo secundário - lado volante / Eje secundario - lado volante / Secondary shaft - steering wheel				L 45449 / L 45410	311405625C	TRB
Lateral coroa (dir./esq.) / Lateral corona (der./izq.) / Crown gear (right/left)				LM 300849 / LM 300811	113517185B	TRB

Eixo Dianteiro / Eje Delantero / Front Axle

Roda / Rueda / Wheel			1.8L * 98...09	F 16036		BBDRAC
Eixo Traseiro / Eje Trasero / Rear Axle			2.0L * 00...03	F 16036		BBDRAC
Roda / Rueda / Wheel				KA 021	096FXIA049AB	KIT
	•		1.8L * 98...09	L 45449 / L 45410		TRB
		•	1.8L * 98...09	LM 11749 / LM 11710		TRB
	•		2.0L * 00...03	L 45449 / L 45410		TRB
		•	2.0L * 00...03	LM 11749 / LM 11710		TRB

Pointer (1.8 * 2.0)

Câmbio / Caja de Cambios / Gearbox

Eixo secund. (dir.) / Eje secundario (der.) / Secondary shaft (right)				L 45449 / L 45410		TRB
Eixo secund. (esq.) / Eje secundario (izq.) / Secondary shaft (left)				LM 29749 / LM 29710		TRB
Alternador (dianteiro) / Alternador (delantero) / Alternator (front)				6303 2RS / C3		BB
Alternador (traseiro) / Alternador (trasero) / Alternator (rear)				6201 2RS / C3		BB

Polo

Diferencial / Diferencial / Differential

Eixo secund. (dianteiro) / Eje secundario (delantero) / Secondary shaft (front)				L 45449 / L 45410		TRB
Eixo secund. (traseiro) / Eje secundario (trasero) / Secondary shaft (rear)				LM 29749 / LM 29710		TRB
Coroa lateral - (dir./esq.) / Lateral corona - (der./izq.) / Crown gear (right/left)				LM 300849 / LM 300811		TRB

Polo Classic

Câmbio / Caja de Cambios / Gearbox

Eixo piloto (dianteiro) / Eje piloto (delantero) / Pilot shaft (front)			01...	F 18024	020311123N	BBS
Eixo secund. (dianteiro) / Eje secundario (delantero) / Secondary shaft (front)				L 45449 / L 45410		TRB
Eixo secund. (traseiro) / Eje secundario (trasero) / Secondary shaft (rear)				LM 29749 / LM 29710		TRB

Diferencial / Diferencial / Differential

Coroa lateral - (dir./esq.) / Lateral corona - (der./izq.) / Crown gear (right/left)				LM 300849 / LM 300811		TRB
--	--	--	--	------------------------------	--	-----

Eixo Dianteiro / Eje Delantero / Front Axle

Roda / Rueda / Wheel			94...96	F 16023	191498625	BBDRAC
			...93	F 16028	861498625/ 867407625 A	BBDRAC
			96...	F 16039	357498625	BBDRAC

	OUT	IN		Fersa®	N° OEM	
---	-----	----	---	---------------	--------	---

VOLKSWAGEN

Santana * Santana Quantum (1.6 * 1.8 * 2.0)

Câmbio / Caja de Cambios / Gearbox

Lateral coroa (dir./esq.) / Lateral corona (der./izq.) / Crown gear (right/left)				LM 300849 / LM 300811	113517185B	TRB
--	--	--	--	------------------------------	------------	-----

Diferencial / Diferencial / Differential

Coroa lateral (dir./esq.) / Lateral corona - (der./izq.) / Crown gear (right/left)				LM 29749 / LM 29710		TRB
--	--	--	--	----------------------------	--	-----

				M 86649 / M 86610		TRB
--	--	--	--	--------------------------	--	-----

Coroa lateral - (dir./esq.) / Lateral corona - (der./izq.) / Crown gear (right/left)				LM 300849 / LM 300811		TRB
--	--	--	--	------------------------------	--	-----

Eixo Traseiro / Eje Trasero / Rear Axle

Roda / Rueda / Wheel				KA 069		KIT
----------------------	--	--	--	---------------	--	-----

	•		1.8 * 2.0L	L 45449 / L 45410	3114056451	TRB
--	---	--	------------	--------------------------	------------	-----

	•		1.8 * 2.0L	LM 11749 / LM 11710	3114056451	TRB
--	---	--	------------	----------------------------	------------	-----

Motor / Motor / Engine

Alternador (dianteiro) / Alternador (delantero) / Alternator (front)			AP 2.0i with AC	6303 2RS / C3		BB
--	--	--	-----------------	----------------------	--	----

Alternador - lado coletor / Alternador - lado colector / Alternator - manifold			Bosch * Wapsa 35 * 45 * 55 * 65 A	6203 2RS / C3		BB
--	--	--	-----------------------------------	----------------------	--	----

			1.8 e 2.0L * Opcional 6201.2ZR.C3	6201 2RS / C3	0299032212	BB
--	--	--	-----------------------------------	----------------------	------------	----

Alternador - lado polia / Alternador - lado polea / Alternator - pulley			1.8 * 2.0L	6203 2RS / C3	80227	BB
---	--	--	------------	----------------------	-------	----

				6303 2RS / C3	80227	BB
--	--	--	--	----------------------	-------	----

Alternador (traseiro) / Alternador (trasero) / Alternator (rear)			70 * 90 A	6203 2RS / C3		BB
--	--	--	-----------	----------------------	--	----

			65 * 70 * 75 * 90 1.8 Mi	6003 2RS / C3		BB
--	--	--	--------------------------	----------------------	--	----

			Bosch * Wapsa 35 * 45 * 55 * 65 * 95 A	6201 2RS / C3		BB
--	--	--	--	----------------------	--	----

Saveiro

Eixo Dianteiro / Eje Delantero / Front Axle

Roda / Rueda / Wheel			1.6L * 09...	F 16036		BBDRAC
----------------------	--	--	--------------	----------------	--	--------

			1.6L * 09...	F 16110		BBDRAC
--	--	--	--------------	----------------	--	--------

Saveiro * Voyage

Diferencial / Diferencial / Differential

Coroa lateral - (dir./esq.) / Lateral corona - (der./izq.) / Crown gear (right/left)				LM 300849 / LM 300811		TRB
--	--	--	--	------------------------------	--	-----

Motor / Motor / Engine

Alternador (dianteiro) / Alternador (delantero) / Alternator (front)			Bosch * Wapsa 35 * 45 * 55 * 65 A	6203 2RS / C3		BB
--	--	--	-----------------------------------	----------------------	--	----

Alternador (traseiro) / Alternador (trasero) / Alternator (rear)			65 * 70 * 75 * 90 1.6 Mi	6003 2RS / C3		BB
--	--	--	--------------------------	----------------------	--	----

			Bosch * Wapsa 35 * 45 * 55 * 65 * 95 A	6201 2RS / C3		BB
--	--	--	--	----------------------	--	----

Sedan

Eixo Dianteiro / Eje Delantero / Front Axle

Roda / Rueda / Wheel	•		1.6L * 80...03	L 45449 / L 45410		TRB
----------------------	---	--	----------------	--------------------------	--	-----

		•	1.6L * 80...03	LM 11749 / LM 11710		TRB
--	--	---	----------------	----------------------------	--	-----



OUT IN



Fersa®

N° OEM



VOLKSWAGEN

Sedan

Eixo Traseiro / Eje Trasero / Rear Axle

Roda / Rueda / Wheel	•	1.6L * 80...03	6306 ZZ / C3		BB
----------------------	---	----------------	--------------	--	----

TC

Eixo Dianteiro / Eje Delantero / Front Axle

Roda / Rueda / Wheel	•		L 45449 / L 45410	3114056251	TRB
	•		LM 11749 / LM 11710	3114056451	TRB

Eixo Traseiro / Eje Trasero / Rear Axle

Roda / Rueda / Wheel			6306 C3	1135012834	BB
----------------------	--	--	---------	------------	----

Van

Eixo Dianteiro / Eje Delantero / Front Axle

Roda / Rueda / Wheel		1.8L * 03...	F 16036		BBDRAC
----------------------	--	--------------	---------	--	--------

Variant

Eixo Dianteiro / Eje Delantero / Front Axle

Roda / Rueda / Wheel		•	L 45449 / L 45410	3114056251	TRB
Eixo Traseiro / Eje Trasero / Rear Axle	•		LM 11749 / LM 11710	3114056451	TRB
Roda / Rueda / Wheel			6306 C3	1135012834	BB

Motor / Motor / Engine

Alternador (dianteiro) / Alternador (delantero) / Alternator (front)		Variant * Bosch	6203 2RS / C3		BB
Alternador - lado coletor / Alternador - lado colector / Alternator - manifold			6201 2RS / C3	1059032211	BB
		Bosch 35A-BP	6202 2RS / C3	111903221Z	BB
Alternador - lado polia / Alternador - lado polea / Alternator - pulley			6203 2RS / C3	1029032211	BB
		Bosch 35A-BP	6203 2RS / C3	1029032211	BB
Alternador (traseiro) / Alternador (trasero) / Alternator (rear)		Variant * Bosch	6201 2RS / C3		BB
		Bosch 35A-BP	6202 2RS / C3		BB
Dínamo / Dinamo / Dynamo		25A-BP	6202 2RS	111903221Z	BB
Dínamo (dianteiro) / Dinamo (delantero) / Dynamo (front)		Bosch 25A-2OU	6202 2RS / C3		BB
Dínamo - lado coletor / Dinamo - lado de colector / Dynamo - manifold		Bosch 25A-2	6201 ZZ / C3	1059032211	BB
Dínamo - polia / Dinamo - polea / Dynamo - pulley		Bosch 25A-2	6202 ZZ	111903221Z	BB
Dínamo (traseiro) / Dinamo (trasero) / Dynamo (rear)		Bosch 25A-2OU	6201 2RS / C3		BB

Variant II

Motor / Motor / Engine

Alternador (dianteiro) / Alternador (delantero) / Alternator (front)		Variant * Bosch	6203 2RS / C3		BB
		Bosch 35A-BP	6203 2RS / C3		BB
Alternador (traseiro) / Alternador (trasero) / Alternator (rear)		Variant * Bosch	6201 2RS / C3		BB
		Bosch 35A-BP	6202 2RS / C3		BB
Dínamo / Dinamo / Dynamo		25A-BP	6202 2RS / C3		BB
Dínamo (dianteiro) / Dinamo (delantero) / Dynamo (front)		Bosch 25A-2OU	6202 2RS / C3		BB
Dínamo (traseiro) / Dinamo (trasero) / Dynamo (rear)		Bosch 25A-2OU	6201 2RS / C3		BB

08

Bearings for Trailer Applications

Rolamentos para Aplicações de Trailer
Rodamientos para Aplicaciones de Trailer





	OUT	IN		Fersa®	Nº OEM	
---	-----	----	---	---------------	--------	---

DINA

400

Eixo Dianteiro / Eje Delantero / Front Axle

Roda / Rueda / Wheel	•			25880 / 25820		TRB
		•		45284 / 45220	2986840	TRB

Eixo Traseiro / Eje Trasero / Rear Axle

Roda / Rueda / Wheel	•			39590 / 39520	1240A / 2986843	TRB
		•		495 AX / 493		TRB

451

Eixo Dianteiro / Eje Delantero / Front Axle

Roda / Rueda / Wheel	•		86-94	25880 / 25820		TRB
		•	86-94	45284 / 45220	2986840	TRB
	•			25877 / 25820		TRB
		•		JM 207049 A / JM 207010		TRB

Eixo Traseiro / Eje Trasero / Rear Axle

Roda / Rueda / Wheel	•			39590 / 39520	1240A / 2986843	TRB
		•		47686 / 47620		TRB

311 * 312 * 314 * 362 * 315G * 316G * 317G6 * 318G * 319G * 321C * 323G

Direção / Dirección / Steering

Braço inferior / Brazo inferior / Lower arm				12168 / 12303		TRB
Braço superior / Brazo superior / Upper arm				12175 / 12303		TRB
Perno de direção / Perno de dirección / Pintle direction				T 163	DIHA 3123 B2A	TRBT

Eixo Dianteiro / Eje Delantero / Front Axle

Roda / Rueda / Wheel	•			3782 / 3720	807949	TRB
		•		HM 212049 / HM 212011		TRB

Eixo Traseiro / Eje Trasero / Rear Axle

Roda / Rueda / Wheel	•			580 / 572	39811405	TRB
		•		594A / 592A	183704	TRB

431K * 432K * 432J * 432J1 * 432J2

Eixo Dianteiro / Eje Delantero / Front Axle

Roda / Rueda / Wheel	•			25880 / 25820		TRB
		•		45284 / 45220	2986840	TRB

Eixo Traseiro / Eje Trasero / Rear Axle

Roda / Rueda / Wheel	•			39590 / 39520	1240A / 2986843	TRB
		•		47686 / 47620		TRB

433 16070

Direção / Dirección / Steering

Perno de direção / Perno de dirección / Pintle direction				T 182	DIHA 3123 A2A	TRBT
--	--	--	--	-------	---------------	------

Eixo Dianteiro / Eje Delantero / Front Axle

Roda / Rueda / Wheel	•			25877 / 25820		TRB
		•		JM 207049 A / JM 207010		TRB

Eixo Traseiro / Eje Trasero / Rear Axle

Roda / Rueda / Wheel	•			39590 / 39520	1240A / 2986843	TRB
		•		47686 / 47620		TRB

455 OF

Caixa de Mudanças / Caja de Cambios / Gearbox

			Tremec FS 5005 No. Fuller 235417 / 235418	M 804049 / M 804010		TRB
--	--	--	--	------------------------	--	-----

	OUT	IN		Fersa [®]	N° OEM	
---	-----	----	---	---------------------------	--------	---

DINA

455 OF

			Tremec FS 5005 No. Fuller 654166 / 791943	25590 / 25520	9414069	TRB
			Tremec FSM 5005 No. Fuller 235417 / 235418	M 804049 / M 804010		TRB
			Tremec FSM 5005 No. Fuller 654166 / 791943	25590 / 25520	9414069	TRB

Eixo Dianteiro / Eje Delantero / Front Axle

Roda / Rueda / Wheel	•			25877 / 25820		TRB
		•		JM 207049 A / JM 207010		TRB

Eixo Traseiro / Eje Trasero / Rear Axle

Roda / Rueda / Wheel	•			39590 / 39520	1240A / 2986843	TRB
		•		47686 / 47620		TRB

500 * 501

Eixo Traseiro / Eje Trasero / Rear Axle

Diferencial / Diferencial / Differential				HM 903249 / HM 903210	931482	TRB
--	--	--	--	----------------------------------	--------	-----

Eixo Dianteiro / Eje Delantero / Front Axle

Roda / Rueda / Wheel	•			3196 / 3120		TRB
		•		33895 / 33821		TRB

Eixo Traseiro / Eje Trasero / Rear Axle

Roda / Rueda / Wheel	•			39590 / 39520	1240A / 2986843	TRB
		•		47686 / 47620		TRB

541 * 542

Caixa de Mudanças / Caja de Cambios / Gearbox

			Tremec FS 5005 No. Fuller 235417 / 235418	M 804049 / M 804010		TRB
			Tremec FS 5005 No. Fuller 654166 / 791943	25590 / 25520	9414069	TRB
			Tremec FSM 5005 No. Fuller 235417 / 235418	M 804049 / M 804010		TRB
			Tremec FSM 5005 No. Fuller 654166 / 791943	25590 / 25520	9414069	TRB

Eixo Dianteiro / Eje Delantero / Front Axle

Roda / Rueda / Wheel	•			3782 / 3720	807949	TRB
		•		HM 212049 / HM 212011		TRB

Eixo Traseiro / Eje Trasero / Rear Axle

Roda / Rueda / Wheel	•			39590 / 39520	1240A / 2986843	TRB
		•		47686 / 47620		TRB



555 OF

Caixa de Mudanças / Caja de Cambios / Gearbox

			Tremec FS 5005 No. Fuller 235417 / 235418	M 804049 / M 804010		TRB
			Tremec FS 5005 No. Fuller 654166 / 791943	25590 / 25520	9414069	TRB
			Tremec FSM 5005 No. Fuller 235417 / 235418	M 804049 / M 804010		TRB
			Tremec FSM 5005 No. Fuller 654166 / 791943	25590 / 25520	9414069	TRB

Eixo Dianteiro / Eje Delantero / Front Axle

Roda / Rueda / Wheel	•			3782 / 3720	807949	TRB
		•		HM 212044 / HM 212011		TRB

	OUT	IN		Fersa [®]	Nº OEM	
---	-----	----	---	---------------------------	--------	---

MERCEDES BENZ

1018 MBO

Caixa de Mudanças / Caja de Cambios / Gearbox

Eixo de entrada (dianteiro) / Eje de entrada (delantero) / Input shaft (front)			LA * LAK * LAS	30308 F		TRB
Eixo de entrada (traseiro) / Eje de entrada (trasero) / Input shaft (rear)			LA * LAK * LAS	30309 F		TRB
Eixo intermediário / Eje intermedio / Intermediate shaft				30308 F		TRB
			LA * LAK * LAS	30309 F		TRB
Eixo primário / Eje primario / Primary shaft				QJ 209 FM		BB4PAC
Eixo secundário (traseiro) / Eje secundario (trasero) / Secondary shaft (rear)				QJ 309 FM		BB4PAC

Cardan / Cardan / Cardan

Suporte / Soporte / Support			L * LK * LS	6208		BB
-----------------------------	--	--	-------------	------	--	----

Eixo Dianteiro / Eje Delantero / Front Axle

Roda / Rueda / Wheel		•	L * LK * LS	30312 F		TRB
	•		L * LK * LS	32307 F		TRB
		•	LA * LAK * LAS	497 / 492 A		TRB

Eixo Traseiro / Eje Trasero / Rear Axle

Roda / Rueda / Wheel		•		32216 F		TRB
----------------------	--	---	--	---------	--	-----

Embreagem / Embrague / Clutch

Apoio / Apoyo / Support				6204		BB
-------------------------	--	--	--	------	--	----

Motor / Motor / Engine

Alternador (dianteiro) / Alternador (delantero) / Alternator (front)			69...75	6303 2RS / C3		BB
Alternador (traseiro) / Alternador (trasero) / Alternator (rear)			69...75	6201 2RS / C3		BB
Bomba d'água - rodam / Bomba de agua - rodam. / Water pump - bearing				30302 F		TRB
Dínamo Bosch (dianteiro) / Dinamo bosch (delantero) / Bosch dynamo (front)			60...74	6303		BB
Dínamo Bosch (traseiro) / Dinamo bosch (trasero) / Bosch dynamo (rear)			60...74	6203		BB
Ventilador (traseiro) / Ventilador (trasero) / Fan (rear)				6304		BB
Virabrequim - ponta / Cigüeñal - punta / Crankshaft spindle			MBO 1018	6205 2RS		BB

1113 OF * 1115 OF

Caixa de Mudanças / Caja de Cambios / Gearbox

Eixo de entrada (traseiro) / Eje de entrada (trasero) / Input shaft (rear)			G 3/36-5/8,98 * G 3/40-5/7,5	30309 F		TRB
Eixo intermediário / Eje intermedio / Intermediate shaft				30308 F	0019813105 / 0019815005	TRB
Eixo Intermediário (dianteiro / traseiro) / Eje Intermedio (delantero / trasero) / Intermediate shaft (front / rear)				30309 F	00198113705	TRB
			G 3/36-5/8,98 * G 3/40-5/7,5	30309 F		TRB
Eixo primário (dianteiro) / Eje primario (delantero) / Primary shaft (front)			G 3/36-5/8,98 * G 3/40-5/7,5	QJ 209 FM	3459817027	BB4PAC
			G 3/50-5/8,5 * G 3/60-5/7,5 G 3/50-5/8,5 + NA 3/60-1B * G 3/60-5/7,5 + NA 3/60-1B	QJ 212 FM	3459817627	BB4PAC
Eixo primário (traseiro) / Eje primario (trasero) / Primary shaft (rear)			G 3/50-5/8 * G 3/60-5/7,5 G 3/50-5/8,5 + NA 3/60-1B * G 3/60-5/7,5 + NA 3/60-1B	F 19011		CRBS
				NU 209FMN	3449817101	CRB

	OUT	IN		Fersa®	Nº OEM	
---	-----	----	---	---------------	--------	---

MERCEDES BENZ

1113 OF * 1115 OF

Eixo primário inf. (dianteiro / traseiro) / Eje primario inf. (delantero / trasero) / Primary shaft (front / rear)				6308 ZRN / C3	3129811325	BB
Eixo primário inf. (traseiro) / Eje primario inf. (trasero) / Primary shaft (rear)				NJ 2211 FM	000628000339	CRB
Eixo primário sup. (dianteiro / traseiro) / Eje primario sup. (delantero / trasero) / Upper primary shaft (front / rear)				30308 F	0019813105 / 0019815005	TRB
Eixo secundário (dianteiro) / Eje secundario (delantero) / Secondary shaft (front)				QJ 309 FM	3459817127 / 3459817727	BB4PAC

Direção / Dirección / Steering

Direção hidráulica - alav.interna (inf.) / Dirección hidráulica - palanca interna (inf.) / Hydraulic direction - inner lever (lower)			LS	30205 F	000720030205	TRB
Direção hidráulica - alav.interna (sup.) / Dirección hidráulica - palanca interna (sup.) / Hydraulic direction - inner lever (upper)			LS	30206 F	000720030206	TRB

Eixo Dianteiro / Eje Delantero / Front Axle

Roda / Rueda / Wheel		•		30312 F	0019819705	TRB
			VL 2/13 C-2.9 1114	32306 F		TRB
		•		32307 F	0039816405	TRB
			VL 2/13 C-2.9 1114	33111 F		TRB
		•		33208 F	3849817605 / 0089810105	TRB
			•	33213 F	0089810005	TRB
		•	497 / 492 A	0009816105	TRB	

Eixo Traseiro / Eje Trasero / Rear Axle

Roda / Rueda / Wheel		•		32216 F	0009817205	TRB
		•		33019 F	00298190 (77...)05 / 0039818605	TRB
		•		33215 F	0029818905 / 0029818605	TRB

Embreagem / Embrague / Clutch

Apoio / Apoyo / Support				6204	000625006204	BB
-------------------------	--	--	--	-------------	--------------	----

Motor / Motor / Engine

Alternador (dianteiro) / Alternador (delantero) / Alternator (front)			OM 366 * 352 * M 352 O ... motor/motor/engine 823236	6303 2RS / C3		BB
				6403 2RS / C3	0049812425	BB
Alternador (traseiro) / Alternador (trasero) / Alternator (rear)			M 352 O * OM 352 ... motor/motor/engine 823236	6201 Z / C3		BB
			OM 366 * OM 352 motor/motor/engine 823237... * OM 364 LA para/para/for 1114	62201 2RS / C3		BB
Bomba d'água / Bomba de agua / Water pump				30302 F	000720030202	TRB
Bomba d'água (dianteiro) / Bomba de agua (delantero) / Water pump (front)				6203 / C3	000625900208	BB
			OM 366 * OM 364 LA para/para/for 1114	6206 C3		BB
Bomba d'água (traseiro) / Bomba de agua (trasero) / Water pump (rear)			OM 366 * OM 364 LA para/para/for 1114	6203 / C3		BB
				6206 C3	000625006206	BB
Bomba hidráulica / Bomba hidráulica / Hydraulic pump				62204 2RS	0049819625	BB
Bomba injetora (dianteiro) / Bomba inyectora (delantero) / Injection pump (front)				30203 F	000720030203	TRB
Bomba servo (dianteira) / Bomba servo (delantero) / Servopump (front)			OM 364 LA para/para/for 1114	62204 2RS		BB
Virabrequim / Cigüeñal / Crankshaft				6204 2RS / C3	000625406204	BB

	OUT	IN		Fersa®	Nº OEM	
---	-----	----	---	---------------	--------	---

MERCEDES BENZ

1113 OF * 1115 OF

Ventilador - comando da ventoinha (esq.) / Ventilador - control del ventilador (izd.) / Fan fan control (left)			OH 1115 L	6304 C3		BB
Virabrequim - ponta / Cigüeñal - punta / Crankshaft spindle			OM 366 * OM 352/A/AI * M352 O * (OM 364 LA para/para/for 1114)	6204 2RS		BB

1215 OF * 1217 OF

Caixa de Mudanças / Caja de Cambios / Gearbox

Eixo de acionamento / Eje de accionamiento / Drive shaft				NUP 2212 FMN		CRB
Eixo de entrada (dianteiro) / Eje de entrada (delantero) / Input shaft (front)			ZG 500-3 M/1,64 * VG 500-3 W/1,64	33210 F		TRB
Eixo Intermediário (dianteiro / traseiro) / Eje Intermedio (delantero / trasero) / Intermediate shaft (front / rear)				32208 F	A0159813405	TRB
Eixo intermediário (entrada) / Eje intermedio (entrada) / Intermediate shaft (input)				3382 / 3320		TRB
Eixo intermediário (saída) / Eje intermedio (salida) / Intermediate shaft (output)				2789 / 2720		TRB
Eixo primário (dianteiro) / Eje primario (delantero) / Primary shaft (front)				QJ 212 FM	3459817627	BB4PAC
Eixo primário (traseiro) / Eje primario (trasero) / Primary shaft (rear)			(L 1215); G 3/60-5/7,5 * G 3/50-5/8,5 * G 3/50-5/8,5 + NA 3/60-1B	F 19011		CRBS
Eixo principal (entrada / saída) / Eje principal (entrada / salida) / Main shaft (input / output)				32210 F	A0159815005	TRB
Eixo principal (saída) / Eje principal (salida) / Main shaft (output)				NUP 310 FMN / C3		CRB
Eixo secundário / Eje secundario / Secondary shaft			G 3/55-6/8,5 (5 vel.) * G 3/55-6/8,5 + NA 3/60-1B	F 19046		CRBS
Eixo secundário (dianteiro) / Eje secundario (delantero) / Secondary shaft (front)				QJ 309 FM	3459817127 / 3459817727	BB4PAC
Eixo secundário (traseiro) / Eje secundario (trasero) / Secondary shaft (rear)			(L 1215) * G 3/60-5/7,5 * G 3/50-5/8,5 * G 3/50-5/8,5 + NA 3/60-1B G 3/60-5/7,5 + NA 3/60-1B	QJ 309 FM		BB4PAC
Tomada de força / Toma de fuerza / Power take-off				6208 N		BB

Eixo Dianteiro / Eje Delantero / Front Axle



Roda / Rueda / Wheel	•			33208 F	3849817605 / 0089810105	TRB
		•		33213 F	0089810005	TRB
		•	AL 4/5 D 4,3 48:7 para/para/for LA 1215	497 / 492 A		TRB

Eixo Traseiro / Eje Trasero / Rear Axle

Roda / Rueda / Wheel				32214 F	001 981 8005	TRB
		•		32216 F	0009817205	TRB
		•		33019 F	00298190 (77...)/05 / 0039818605	TRB
	•			33020 F	0059818505	TRB
		•		33117 F	0059818605	TRB
		•		33215 F	0029818905	TRB

Motor / Motor / Engine

Alternador (dianteiro) / Alternador (delantero) / Alternator (front)				6403 2RS / C3	0049812425	BB
Alternador (traseiro) / Alternador (trasero) / Alternator (rear)				62201 2RS / C3	00298190 (77...)/95	BB
Bomba d'água (dianteiro) / Bomba de agua (delantero) / Water pump (front)				6206 C3	000625900209	BB
Bomba d'água (traseiro) / Bomba de agua (trasero) / Water pump (rear)				6203 / C3	000625900208	BB
Bomba hidráulica / Bomba hidráulica / Hydraulic pump				62204 2RS	0049819625	BB

	OUT	IN		Fersa®	Nº OEM	
---	-----	----	---	---------------	--------	---

MERCEDES BENZ

1215 OF * 1217 OF

Bomba injetora (dianteiro) / Bomba inyectora (delantero) / Injection pump (front)				30203 F	000720030203	TRB
Bomba injetora (traseiro) / Bomba inyectora (traseiro) / Injection pump (rear)				30204 F	000720030204	TRB
Bomba servo (dianteira) / Bomba servo (delantero) / Servopump (front)			OM 366 para/para/for LA, LK 1215	62204 2RS		BB
Virabrequim / Cigüeñal / Crankshaft				6204 2RS / C3	000625406204	BB
Virabrequim - ponta / Cigüeñal - punta / Crankshaft spindle			OM 366 * OM 366 A * (L 1215) * OM 364 LA para/para/for 1214C e 1214 K	6204 2RS		BB

1313 OF * 1314 OF * 1315 OF * 1316 OF * 1317 OF * 1318 OF * 1319 OF * 1320 OF

Caixa de Mudanças / Caja de Cambios / Gearbox

Eixo de entrada (traseiro) / Eje de entrada (traseiro) / Input shaft (rear)			ZG 500-3 M/1,64 * VG 500-3 W/1,64	33209 F		TRB
Eixo de saída (dianteiro / traseiro) / Eje de salida (delantero / traseiro) / Output shaft (front)			ZG 500-3 M/1,64 * VG 500-3 W/1,64	33011 F		TRB
			ZG 500-3 M/1,64 * VG 500-3 W/1,64	33113 F		TRB
			ZG 500-3 M/1,64 * VG 500-3 W/1,64	6211 N / C3		BB
Eixo intermediário (dianteiro) / Eje intermedio (delantero) / Intermediate shaft (front)				33210 F	0039818305	TRB
Eixo Intermediário (dianteiro / traseiro) / Eje Intermedio (delantero / traseiro) / Intermediate shaft (front / rear)				30309 F	00198113705	TRB
			G 3/40-5/7,5 * G 3/36-5/8,98 G 3/60-5/7,5 + NA 3/60-1B * G 3/60-5/8,5 + NA 3/60-1B	30308 F	0019813105 / 0019815005	TRB
Eixo intermediário (traseiro) / Eje intermedio (traseiro) / Intermediate shaft (rear)				33212 F	0059812805	TRB
Eixo primário (dianteiro) / Eje primario (delantero) / Primary shaft (front)				QJ 212 FM	3459817627	BB4PAC
Eixo primário (traseiro) / Eje primario (traseiro) / Primary shaft (rear)			G 3/60-5/7,5 + NA 3/60-1B G 3/60-5/8,5 + NA 3/60-1B * G 3/60-5/7,5	F 19011		CRBS
Eixo primário inf. (dianteiro / traseiro) / Eje primario inf. (delantero / traseiro) / Primary shaft - lower (front / rear)				6308 ZNR / C3	3129811325	BB
				6211 N / C3	0019819125	BB
				33112 F		TRB
				33011 F	0029819305	TRB
				NJ 2211 FM	000628000339	CRB
Eixo primário sup. (dianteiro) / Eje primario sup. (delantero) / Upper primary shaft (front)				30309 F	00198113705	TRB
				33210 F	0039818305	TRB
Eixo primário sup. (traseiro) / Eje primario sup. (traseiro) / Upper primary shaft (rear)				30308 F	0019813105 / 0019815005	TRB
				33209 F	0039815705	TRB
				QJ 309 FM	3459817127 / 3459817727	BB4PAC

Eixo Dianteiro / Eje Delantero / Front Axle

Roda / Rueda / Wheel	•		AL 4/50-4,3/48:7	30214 F		TRB
	•			32307 F	0039816405	TRB
	•			33208 F	3849817605 / 0089810105	TRB
	•			33209 F	0039815705	TRB

	OUT	IN		Fersa [®]	N° OEM	
---	-----	----	---	---------------------------	--------	---

MERCEDES BENZ

1313 OF * 1314 OF * 1315 OF * 1316 OF * 1317 OF * 1318 OF * 1319 OF * 1320 OF

Roda / Rueda / Wheel		•	VL 3/7 D-5	33213 F	0089810005	TRB
		•	VL 3/7 D-5	33214 F		TRB
		•		33214 F	0039815605 / 0039815205	TRB
		•	AL 4/50-4,3/48:7	497 / 492 A	0009816105	TRB

Eixo Traseiro / Eje Trasero / Rear Axle

Roda / Rueda / Wheel		•		33019 F	00298190 (77...)05 / 0039818605	TRB
		•		33020 F	0059818505	TRB
		•		33117 F	0059818605	TRB
		•		33215 F	0029818905 / 0029818605	TRB
		•		598A / 593 X	0039811405	TRB

Embreagem / Embrague / Clutch

Desengate / Desembrague / Clutch				6204 2RS	000625406104	BB
----------------------------------	--	--	--	-----------------	--------------	----

Motor / Motor / Engine

Alternador (dianteiro) / Alternador (delantero) / Alternator (front)			OM 366 A/G * OM 366 * OM 352 I	6303 2RS / C3	000625406303	BB
				6403 2RS / C3		BB
Alternador (traseiro) / Alternador (trasero) / Alternator (rear)				6201 2RS / C3	0049812425	BB
				62201 2RS / C3	000625406303	BB
Bomba d'água (dianteiro) / Bomba de agua (delantero) / Water pump (front)			OM 352 * OM 352 A * OM 352 I	6203 / C3		BB
				6206 C3	000625900209	BB
Bomba d'água (dianteiro / traseiro) / Bomba de agua (delantero / trasero) / Water pump (front / rear)				6203 / C3	000625900208	BB
Bomba d'água (traseiro) / Bomba de agua (trasero) / Water pump (rear)			OM 366 * OM 366 A * OM 366 G * OM 366 LA	6203 / C3		BB
			OM 352 * OM 352 A * OM 352 I	6206 C3		BB
Bomba hidráulica / Bomba hidráulica / Hydraulic pump				62204 2RS	0049819625	BB
Bomba injetora (dianteiro) / Bomba inyectora (delantero) / Injection pump (front)				30203 F	000720030203	TRB
				30205 F	000720030205	TRB
Bomba injetora (traseiro) / Bomba inyectora (trasero) / Injection pump (rear)				30204 F	000720030204	TRB
			OM 366	30205 F		TRB
			OM 366 LA	30206 F		TRB
Virabrequim / Cigüeñal / Crankshaft				6204 2RS / C3	000625406204	BB
Polia tensora / Polea tensora / Tensioner pulley				6303	000635006303	BB
Ventilador (traseiro) / Ventilador (trasero) / Fan (rear)				6304 C3	000635006303	BB
Virabrequim - ponta / Cigüeñal - punta / Crankshaft spindle			OM 366/A * OM 352/A/I * OM 366 G * OM 366 LA	6204 2RS		BB

1417 OF * 1419 OF * 1421 OF

Caixa de Mudanças / Caja de Cambios / Gearbox

Eixo de acionamento / Eje de accionamiento / Drive shaft				NUP 2212 FMN		CRB
Eixo intermediário / Eje intermedio / Intermediate shaft				2789 / 2720		TRB
				3382 / 3320		TRB
Eixo Intermediário (dianteiro / traseiro) / Eje Intermedio (delantero / trasero) / Intermediate shaft (front / rear)				30309 F	00198113705	TRB
				30308 F	0019813105 / 0019815005	TRB

	OUT	IN		Fersa®	Nº OEM	
---	-----	----	---	---------------	--------	---

MERCEDES BENZ

1417 OF * 1419 OF * 1421 OF

Eixo Intermediário (dianteiro / traseiro) / Eje Intermedio (delantero / trasero) / Intermediate shaft (front / rear)				32208 F	A0159813405	TRB
			G 3/61-5/6,1 * G 3/60-5/7,5 * G 3/50-5/8,5 * G 3/60-5/7,5 + NA 3/60-1B * G 3/50-5/8,5 + NA 3/60-1B * G 3/60-5/8,5 + NA 3/60-1B	30308 F		TRB
Eixo primário / Eje primario / Primary shaft			G 3/55-6/8,5	F 19047		CRBS
Eixo primário (dianteiro) / Eje primario (delantero) / Primary shaft (front)			G 3/61-5/6,1 * G 3/60-5/7,5 * G 3/50-5/8,5 * G 3/50-5/8,5 + NA 3/60-1B * G 3/60-5/8,5 + NA 3/60-1B * G 3/5-5/8,5	QJ 212 FM		BB4PAC
				QJ 212 FM	3459817627	BB4PAC
Eixo primário (traseiro) / Eje primario (trasero) / Primary shaft (rear)			G 3/61-5/6,1 * G 3/60-5/7,5 * G 3/50-5/8,5 * G 3/50-5/8,5 + NA 3/60-1B * G 3/60-5/8,5 + NA 3/60-1B * G 3/5-5/8,5	F 19011		CRBS
Eixo primário inf. (dianteiro / traseiro) / Eje primario inf. (delantero / trasero) / Primary shaft - lower (front / rear)				NJ 2211 FM	000628000339	CRB
Eixo primário sup. (dianteiro) / Eje primario sup. (delantero) / Upper primary shaft (front)				30309 F	00198113705	TRB
Eixo primário sup. (traseiro) / Eje primario sup. (trasero) / Upper primary shaft (rear)				30308 F	0019813105 / 0019815005	TRB
Eixo principal / Eje principal / Main shaft				NUP 310 FMN / C3		CRB
Eixo principal (entrada / saída) / Eje principal (entrada / salida) / Main shaft (input / output)				32210 F	A0159815005	TRB
Eixo secundário / Eje secundario / Secondary shaft			G 3/55-6/8,5	F 19046		CRBS
Eixo secundário (traseiro) / Eje secundario (trasero) / Secondary shaft (rear)			G 3/55-6/8,5	F 19046		CRBS
				QJ 309 FM	3459817127 / 3459817727	BB4PAC
Tomada de força / Toma de fuerza / Power take-off				6208 N		BB
Direção / Dirección / Steering						
Inferior / Inferior / Lower				30205 F	000720030205	TRB
Braço superior / Brazo superior / Upper arm				30206 F	000720030206	TRB
Eixo Dianteiro / Eje Delantero / Front Axle						
Roda / Rueda / Wheel	•			33208 F	3849817605 / 0089810105	TRB
	•			33210 F	003 981 8305	TRB
		•		33213 F	0089810005	TRB
		•		33214 F	003 981 5205	TRB
		•		559 / 552 A	3449817005	TRB
	•		VL 3/7 D-5 (504304 38/39/40/41/44/45/46/47/50/51) * VL 3/8 D-6,5	33210 F		TRB
Eixo Traseiro / Eje Trasero / Rear Axle						
Roda / Rueda / Wheel		•	HL 4/D2-8/46:7	32216 F		TRB
		•		33019 F	00298190 (77...)05 / 0039818605	TRB
	•			33020 F	0059818505	TRB
		•		33020 F	014 981 3205	TRB
	•			33116 F	012 981 4005	TRB
	•		HH 4/05 D-10/43:10 * HH 4/07 DL-10/41:7 * HH 4/07 DL-10/47:9	33117 F		TRB

	OUT	IN		Fersa [®]	N° OEM	
---	-----	----	---	---------------------------	--------	---

MERCEDES BENZ

1417 OF * 1419 OF * 1421 OF

Roda / Rueda / Wheel		•		33117 F	0059818605	TRB
	•			33215 F	0029818905 / 0029818605	TRB
		•		598A / 593 X	0039811405	TRB

Motor / Motor / Engine

Alternador (dianteiro) / Alternador (delantero) / Alternator (front)				6303 2RS / C3	000625406303 / 000625900193	BB
				6304 2RS / C3	0049812425	BB
			OM 366 * OM 366 A (Bosch/Valeo 14V 55 A) * OM 366 LA II/23	6403 2RS / C3		BB
Alternador (traseiro) / Alternador (trasero) / Alternator (rear)				62201 2RS / C3	00298190 (77...)95	BB
Bomba d'água (dianteiro) / Bomba de agua (delantero) / Water pump (front)				6203	000625900208	BB
Bomba d'água (traseiro) / Bomba de agua (trasero) / Water pump (rear)				6206	000625006206	BB
			OM 366 * OM 366 A * OM 366 LA	6203 / C3		BB
Bomba hidráulica / Bomba hidráulica / Hydraulic pump				62204 2RS	0049819625	BB
Bomba injetora (dianteiro) / Bomba inyectora (delantero) / Injection pump (front)				30203 F	000720030203	TRB
				30204 F	000720030204	TRB
Virabrequim / Cigüeñal / Crankshaft				6204 2RS / C3	000625406204	BB
Polia tensora (dianteiro) / Polea tensora (delantero) / Tensioner pulley (front)				30205 F	000720030205	TRB
Polia tensora (traseiro) / Polea tensora (trasero) / Tensioner pulley (rear)				30204 F	000720030204	TRB
Polia tensora - rodam (dianteiro) / Polea tensora - rodam. delantero / Tensioner pulley - bearing (front)			OM 355/5 * OH-1419/1420	30205 F		TRB
Polia tensora - rodam (traseiro) / Polea tensora - rodam. trasero / Tensioner pulley - bearing (rear)			OM 355/5 * OH-1419/1420	30204 F		TRB
Ventilador (dianteiro) / Ventilador (delantero) / Fan (front)				30205 F	000720030205	TRB
Ventilador (traseiro) / Ventilador (trasero) / Fan (rear)				30204 F	000720030204	TRB
Virabrequim - ponta / Cigüeñal - punta / Crankshaft spindle			OM 366/A * OM 355/5	6204 2RS		BB
			OM 366 * OM 366 A * OM 366 LA * OM 366 LA II/23	6204 2RS		BB

1421 OMC

Caixa de Mudanças / Caja de Cambios / Gearbox

Eixo de acionamento / Eje de accionamiento / Drive shaft				NUP 2212 FMN		CRB
Eixo intermediário / Eje intermedio / Intermediate shaft				2789 / 2720		TRB
				3382 / 3320		TRB
Eixo Intermediário (dianteiro / traseiro) / Eje Intermedio (delantero / trasero) / Intermediate shaft (front / rear)				30309 F	00198113705	TRB
				30308 F	0019813105 / 0019815005	TRB
				32208 F	A0159813405	TRB
			G 3/61-5/6,1 * G 3/60-5/7,5 * G 3/50-5/8,5 * G 3/60-5/7,5 + NA 3/60-1B * G 3/50-5/8,5 + NA 3/60-1B * G 3/60-5/8,5 + NA 3/60-1B	30308 F		TRB
Eixo primário / Eje primario / Primary shaft			G 3/55-6/8,5	F 19047		CRBS

	OUT	IN		Fersa®	N° OEM	
---	-----	----	---	---------------	--------	---

MERCEDES BENZ

1421 OMC

Eixo primário (dianteiro) / Eje primario (delantero) / Primary shaft (front)			G 3/61-5/6,1 * G 3/60-5/7,5 * G 3/50-5/8,5 * G 3/50-5/8,5 + NA 3/60-1B * G 3/60-5/8,5 + NA 3/60-1B * G 3/5-5/8,5	QJ 212 FM		BB4PAC
				QJ 212 FM	3459817627	BB4PAC
Eixo primário (traseiro) / Eje primario (trasero) / Primary shaft (rear)			G 3/61-5/6,1 * G 3/60-5/7,5 * G 3/50-5/8,5 * G 3/50-5/8,5 + NA 3/60-1B * G 3/60-5/8,5 + NA 3/60-1B * G 3/5-5/8,5	F 19011		CRBS
Eixo primário inf. (dianteiro / traseiro) / Eje primario inf. (delantero / trasero) / Primary shaft - lower (front / rear)				NJ 2211 FM	000628000339	CRB
Eixo primário sup. (dianteiro) / Eje primario sup. (delantero) / Upper primary shaft (front)				30309 F	00198113705	TRB
Eixo primário sup. (traseiro) / Eje primario sup. (trasero) / Upper primary shaft (rear)				30308 F	0019813105 / 0019815005	TRB
Eixo principal / Eje principal / Main shaft				NUP 310 FMN / C3		CRB
Eixo principal (entrada / saída) / Eje principal (entrada / salida) / Main shaft (input / output)				32210 F	A0159815005	TRB
Eixo secundário / Eje secundario / Secondary shaft			G 3/55-6/8,5	F 19046		CRBS
Eixo secundário (traseiro) / Eje secundario (trasero) / Secondary shaft (rear)			G 3/55-6/8,5	F 19046		CRBS
				QJ 309 FM	3459817127 / 3459817727	BB4PAC
Tomada de força / Toma de fuerza / Power take-off				6208 N		BB
Direção / Dirección / Steering						
Inferior / Inferior / Lower				30205 F	000720030205	TRB
Braço superior / Brazo superior / Upper arm				30206 F	000720030206	TRB
Eixo Dianteiro / Eje Delantero / Front Axle						
Roda / Rueda / Wheel	•			33208 F	3849817605 / 0089810105	TRB
	•			33210 F	003 981 8305	TRB
		•		33213 F	0089810005	TRB
		•		33214 F	003 981 5205	TRB
		•		559 / 552 A	3449817005	TRB
	•		VL 3/7 D-5 (504304 38/39/ 40/41/44/45/46/47/50/51)* VL 3/8 D-6,5	33210 F		TRB
Eixo Traseiro / Eje Trasero / Rear Axle						
Roda / Rueda / Wheel		•	HL 4/D2-8/46:7	32216 F		TRB
		•		33019 F	00298190 (77...)05 / 0039818605	TRB
	•			33020 F	0059818505	TRB
		•		33020 F	014 981 3205	TRB
	•			33116 F	012 981 4005	TRB
	•		HH 4/05 D-10/43:10 * HH 4/07 DL-10/41:7 * HH 4/07 DL-10/47:9	33117 F		TRB
		•		33117 F	0059818605	TRB
	•			33215 F	0029818905 / 0029818605	TRB
		•		598A / 593 X	0039811405	TRB

	OUT	IN		Fersa®	N° OEM	
---	-----	----	---	---------------	--------	---

MERCEDES BENZ

1421 OMC

Motor / Motor / Engine

Alternador (dianteiro) / Alternador (delantero) / Alternator (front)				6303 2RS / C3	000625406303 / 000625900193	BB
Alternador (dianteiro) / Alternador (delantero) / Alternator (front)				6304 2RS / C3	0049812425	BB
			OM 366 * OM 366 A (Bosch/Valeo 14V 55 A) * OM 366 LA II/23	6403 2RS / C3		BB
Alternador (traseiro) / Alternador (trasero) / Alternator (rear)				62201 2RS / C3	00298190 (77...)95	BB
Bomba d'água (dianteiro) / Bomba de agua (delantero) / Water pump (front)				6203	000625900208	BB
Bomba d'água (traseiro) / Bomba de agua (trasero) / Water pump (rear)				6206	000625006206	BB
			OM 366 * OM 366 A * OM 366 LA	6203 / C3		BB
Bomba hidráulica / Bomba hidráulica / Hydraulic pump				62204 2RS	0049819625	BB
Bomba injetora (dianteiro) / Bomba inyectora (delantero) / Injection pump (front)				30203 F	000720030203	TRB
				30204 F	000720030204	TRB
Virabrequim / Cigüeñal / Crankshaft				6204 2RS / C3	000625406204	BB
Polia tensora (dianteiro) / Polea tensora (delantero) / Tensioner pulley (front)				30205 F	000720030205	TRB
Polia tensora (traseiro) / Polea tensora (trasero) / Tensioner pulley (rear)				30204 F	000720030204	TRB
Polia tensora - rodam (dianteiro) / Polea tensora - rodam. delantero / Tensioner pulley - bearing (front)			OM 355/5 * OH-1419/1420	30205 F		TRB
Polia tensora - rodam (traseiro) / Polea tensora - rodam. trasero / Tensioner pulley - bearing (rear)			OM 355/5 * OH-1419/1420	30204 F		TRB
Ventilador (dianteiro) / Ventilador (delantero) / Fan (front)				30205 F	000720030205	TRB
Ventilador (traseiro) / Ventilador (trasero) / Fan (rear)				30204 F	000720030204	TRB
Virabrequim - ponta / Cigüeñal - punta / Crankshaft spindle			OM 366/A * OM 355/5	6204 2RS		BB
			OM 366 * OM 366 A * OM 366 LA * OM 366 LA II/23	6204 2RS		BB

1517 OF * 1518 OF * 1520 OF

Caixa de Mudanças / Caja de Cambios / Gearbox



Eixo de entrada / Eje de entrada / Input shaft				6209 C3	000625036209	BB
			718052	6209 C3		BB
Eixo de saída (traseiro) / Eje de salida (trasero) / Output shaft (rear)				6007 N	000625506007	BB
				6208 N	000625506208	BB
Eixo intermediário / Eje intermedio / Intermediate shaft				6208 N	000625506208	BB
Eixo intermediário (dianteiro) / Eje intermedio (delantero) / Intermediate shaft (front)				33885 / 33822	0019809602	TRB
Eixo Intermediário (dianteiro / traseiro) / Eje Intermedio (delantero / trasero) / Intermediate shaft (front / rear)				30308 F	0019813105 / 0019815005	TRB
				33889 / 33822	0019809502	TRB
Eixo primário / Eje primario / Primary shaft				6208 N	000625506208	BB
			AK 6-80/9,0	NUP 314 FMNR / C3		CRB
Eixo primário (dianteiro) / Eje primario (delantero) / Primary shaft (front)				QJ 209 FM	3459817027	BB4PAC
				QJ 212 FM	3459817627	BB4PAC
Eixo primário (traseiro) / Eje primario (trasero) / Primary shaft (rear)			3/60-5/6,1 * G 3/61-5/6,1 * G 3/50-5/8,5 * G 3/60-5/7,5 * AK 6-80/9,0 * AK 6-80/9,0 GV 80 * G 3/60-5/7,5 + NA 3/60-1B * G 3/60-5/8	F 19011		CRBS

	OUT	IN		Fersa®	Nº OEM	
---	-----	----	---	---------------	--------	---

MERCEDES BENZ

1517 OF * 1518 OF * 1520 OF



				NU 209FMN	3449817101	CRB
Eixo secundário / Eje secundario / Secondary shaft				F 19019	49815801	CRBS
Eixo secundário (interm.) / Eje secundario (interm.) / Secondary shaft (interm.)			LP/LPK/LPS-1520	NUP 314 FM		CRB
Eixo secundário (traseiro) / Eje secundario (trasero) / Secondary shaft (rear)			LP/LPK/LPS-1520	6314		BB
				6314 NR / C3	00198190 (77...)25	BB
			G 3/60-5/6,1 * G 3/36-5/8,98 * G 3/40-5/7,5 * G 3/61-5/6,1 * G 3/50-5/8,5 * G 3/60-5/7,5 * AK 6-80/9,0 * AK 6-80/9,0 GV 80 * G 3/60-5/7,5 + NA 3/60-1B	QJ 309 FM		BB4PAC
				QJ 309 FM	3459817127 / 3459817727	BB4PAC
Motora traseira / Motor trasero / Rear engine				NUP 314 FM / C3	0019809802	CRB
Cardan / Cardan / Cardan						
Suporte / Soporte / Support				6210	000625006210	BB
			LP/LPK/LPS-1520	6210		BB
Eixo Dianteiro / Eje Delantero / Front Axle						
Roda / Rueda / Wheel		•	LP/LPK/LPS-1520	30313 F		TRB
		•		32307 F	0039816405	TRB
		•	LP/LPK/LPS-1520	32309 F		TRB
		•		33208 F	3849817605 / 0089810105	TRB
		•		33213 F	0089810005	TRB
		•		559 / 552 A	3449817005	TRB
Eixo Traseiro / Eje Trasero / Rear Axle						
Roda / Rueda / Wheel	•			32216 F	0009817205	TRB
		•		32218 F	000720032218	TRB
		•		33019 F	00298190 (77...)05 / 0039818605	TRB
		•		33020 F	0059818505	TRB
	•			33117 F	0059818605	TRB
	•			33215 F	0029818905 / 0029818605	TRB
				497 / 492 A	0009816105	TRB
				498 / 492 A	0039812005	TRB
	•		LP/LPK/LPS-1520	580 / 572 A		TRB
		•		598 A / 593 X	0039811405	TRB
				H 715345 / H 715311	0319811805	TRB
	Embreagem / Embrague / Clutch					
Apoyo / Apoyo / Support			344938/955/963	6204 2RS		BB
				6204 2RS / C3	000625406204	BB
				6205 2RS	000625406205	BB
Motor / Motor / Engine						
Alternador (dianteiro) / Alternador (delantero) / Alternator (front)				6303 2RS / C3	000625406303 / 000625900193	BB
				6303 RSR / C3	000625900182	BB
Alternador (dianteiro / traseiro) / Alternador (delantero / trasero) / Alternator (front / rear)				6403 2RS / C3	0049812425 / 0049811825	BB
Alternador (traseiro) / Alternador (trasero) / Alternator (rear)				6201 2RS / C3	0089810705	BB
				6201 RS / C3	0049812425	BB

	OUT	IN		Fersa [®]	Nº OEM	
---	-----	----	---	---------------------------	--------	---

MERCEDES BENZ

1517 OF * 1518 OF * 1520 OF

Alternador (traseiro) / Alternador (trasero) / Alternator (rear)				6204 2RS / C3	000625406204	BB
				6205 2RS	000625406205	BB
				62201 2RS / C3	00298190 (77...)25	BB
			OM 352 A I ... motor/motor/engine 822956 * OM 352 A motor/motor/engine 823237...* OM 352 I ... motor/motor/engine 823236 * OM 355 A * OM 355/5I ... motor/motor/engine 074525	6403 2RS / C3		BB
Bomba d'água (dianteiro) / Bomba de agua (delantero) / Water pump (front)				6204	000625006204	BB
Bomba d'água (dianteiro / traseiro) / Bomba de agua (delantero / trasero) / Water pump (front / rear)				6203 / C3	000625900208	BB
Bomba d'água (traseiro) / Bomba de agua (trasero) / Water pump (rear)				6004	000625006004	BB
			OM 366 A/LA	6203 / C3		BB
				6206 C3	000625900209	BB
				NU 303 FM	0019819601	CRB
Bomba hidráulica / Bomba hidráulica / Hydraulic pump				62204 2RS	0049819625	BB
Bomba injetora (dianteiro) / Bomba inyectora (delantero) / Injection pump (front)				6305	000625006305	BB
				30203 F	000720030203	TRB
				32205 F	000720032205	TRB
Bomba injetora (dianteiro / traseiro) / Bomba inyectora (delantero / trasero) / Injection pump (front / rear)			OM 355/5A	32205 BF		TRB
Bomba injetora (traseiro) / Bomba inyectora (trasero) / Injection pump (rear)				6205	000625006205	BB
				30205 F	000720030205	TRB
Compressor / Compresor / Compressor			LP-1520	6011	305FMC3	BB
Compressor (dianteiro) / Compresor (delantero) / Compressor (front)			OM 355/5A	NJ 305 C3		TRB
Compressor de ar / Compresor de aire / Air compressor				6011	000625006011	BB
				6305	000625006305	BB
Compressor de ar (dianteiro) / Compresor de aire (delantero) / Air compressor (front)				NJ 305 FM / C3	005412400004	CRB
				NUP 206 FM	005412400004	CRB
Compressor - árvore / Compresor - eje de la turbina / Compressor shaft turbine			LP/LPK/LPS-1520	6305		BB
Dínamo Bosch (dianteiro) / Dinamo bosch (delantero) / Bosch dynamo (front)			LP/LPK/LPS-1520	6204		BB
Dínamo Bosch (traseiro) / Dinamo bosch (trasero) / Bosch dynamo (rear)			LP/LPK/LPS-1520	6004		BB
Polia tensora (dianteiro) / Polea tensora (delantero) / Tensioner pulley (front)				30205 F	000720030205	TRB
Polia tensora (traseiro) / Polea tensora (trasero) / Tensioner pulley (rear)				30204 F	000720030204	TRB
Ventilador (dianteiro) / Ventilador (delantero) / Fan (front)				30205 F	000720030205	TRB
Ventilador (traseiro) / Ventilador (trasero) / Fan (rear)				30204 F	000720030204	TRB
Virabrequim - ponta / Cigüeñal - punta / Crankshaft spindle			OM 352 A * OM 355 * OM 366 A/LA * OM 352	6204 2RS		BB
			OM 355 A/5-I	6205 2RS		BB
Caixa de Mudanças / Caja de Cambios / Gearbox						
Eixo de acionamento / Eje de accionamiento / Drive shaft				NUP 2212 FMN		CRB
				NUP 310 FMN / C3		CRB

	OUT	IN		Fersa®	N° OEM	
MERCEDES BENZ						
1618 OF						
Eixo intermediário (dianteiro) / Eje intermedio (delantero) / Intermediate shaft (front)				33885 / 33822	0019809602	TRB
			S 6-90/9,01 * 16 S-130 * S 6-90/9,01 + N 70/18 * S 6-90/6,98 * 8 S-1350 * S 6-1550/6,98 * S 6-1550 * S 6-105	F 15047		TRBS
Eixo Intermediário (dianteiro / traseiro) / Eje Intermedio (delantero / trasero) / Intermediate shaft (front / rear)				30308 F	0019813105 / 0019815005	TRB
				33889 / 33822	0019809502	TRB
			G 3/60-5/7,5 * G 3/50-5/8,5 * G 3/55-6/8,5 * G 3/50-5/8,5 * G 3/60-5/7,5 + NA 3/60-1B * G 3/50-5/8,5 + NA 3/60-1B * 16 S-1650 * S 6-1550/6,98 + ESI	30308 F		TRB
Eixo intermediário (saída) / Eje intermedio (salida) / Intermediate shaft (output)				32309 F		TRB
Eixo intermediário (traseiro) / Eje intermedio (trasero) / Intermediate shaft (rear)				30309 F	00198113705	TRB
			S 6-90/9,01 * S 6-90/9,0 + N 70/18 * S 6-90/6,98 * S 6-1550/6,98 * S 6-1550 * S 6-105 * S 6-1550/6,98 + ESI	32309 F		TRB
			16 S-130 * 8 S-1350 * 16 S-1650	32310 F		TRB
Eixo primário / Eje primario / Primary shaft			S 6-90/9,0 + N 70/18 (ZF)	6208 N		BB
			G 3/50-5/8,5	F 19047		CRBS
			S 6-90/9,01 (ZF) * S 6-1550/6,98 * S 6-90/6,98 * S 6-1550	NUP 314 FMNR / C3		CRB
				6208 N	000625506208	BB
				NUP 314 FM / C3	0019819802	CRB
Eixo primário (dianteiro) / Eje primario (delantero) / Primary shaft (front)			G 3/60-5/7,5 * G 3/50-5/8,5 * G 3/60-5/7,5 + NA 3/60-1B * G 3/50-5/8,5 + NA 3/60-1B	QJ 212 FM		BB4PAC
				QJ 212 FM	3459817627	BB4PAC
Eixo primário (traseiro) / Eje primario (trasero) / Primary shaft (rear)			G 3/60-5/7,5 * G 3/50-5/8,5 * G 3/60-5/7,5 + NA 3/60-1B * G 3/50-5/8,5 + NA 3/60-1B	F 19011		CRBS
				NU 209FMN	0019811701	CRB
Eixo principal (saída) / Eje principal (salida) / Main shaft (output)				NUP 310 FMN / C3		CRB
Eixo secundário / Eje secundario / Secondary shaft				F 19019	49815801	CRBS
			4 S-120 GP * 4 S-120 GP + N 70/18	NUP 311 FMNR / C3		CRB
Eixo secundário (traseiro) / Eje secundario (trasero) / Secondary shaft (rear)			S 6-1550/6,98 * S 6-90/6,98	6314 C3		BB
			G 3/55-6/8,5	F 19046		CRBS
			S 6-1550 * S 6-105 * S 6-1550/6,98 + ESI	NUP 314 FMNR / C3		CRB
			G 3/60-5/7,5 * G 3/50-5/8,5 * G 3/60-5/7,5 + NA 3/60-1B	QJ 309 FM		BB4PAC

	OUT	IN		Fersa [®]	Nº OEM	
---	-----	----	---	---------------------------	--------	---

MERCEDES BENZ

1618 OF

Eixo secundário (traseiro) / Eje secundario (trasero) / Secondary shaft (rear)				QJ 309 FM	3459817127 / 3459817727	BB4PAC
Tampa (traseiro) / Cubierta (trasero) / Cover (rear)			16 S-130 * 8 S-1350 * 16 S-1650	6218 C3		BB
Tomada de força / Toma de fuerza / Power take-off				6208 N		BB

Cardan / Cardan / Cardan

Suporte / Soporte / Support				6210	000625006210	BB
-----------------------------	--	--	--	-------------	--------------	----

Direção / Dirección / Steering

Alavanca intermediária / Palanca intermedia / Intermediate lever			OF-1618/1620	30205 F		TRB
			OF-1618/1620	30206 F		TRB

Eixo Dianteiro / Eje Delantero / Front Axle

Roda / Rueda / Wheel	•		VL 4/37 DL-6,7 * VL 4/37 DL-7,1	32310 F		TRB
		•		32310 F	0019817405	TRB
	•			33208 F	3849817605 / 0089810105	TRB
	•			33210 F	0039818305	TRB
		•		33213 F	0089810005	TRB
		•		33214 F	0039815605 / 0039815205	TRB
	•			F 15051 C	0059813105	TRBS

Eixo Traseiro / Eje Trasero / Rear Axle

Roda / Rueda / Wheel	•		HL 7/021 D-10/26:24 * HL 7/021 D-10/3:7	32019 XF		TRB
	•			32019 XF	0029815405	TRB
		•		33019 F	00298190 (77...)05 / 0039818605	TRB
	•			33019 F	00298190 (77...)05 / 0039818605	TRB
		•		33020 F	0059818505	TRB
		•		33020 F	014 981 3205	TRB
		•		33021 F	0039812605	TRB
	•			33116 F	012 981 4005	TRB
	•			33117 F	0059818605	TRB
	•			33215 F	0029818905 / 0029818605	TRB

Motor / Motor / Engine

Alternador (dianteiro) / Alternador (delantero) / Alternator (front)				6303 2RS / C3	000625406303 / 000625900193	BB
				6303 RSR / C3	000625900182	BB
				6403 C3	0049812425	BB
Alternador (traseiro) / Alternador (trasero) / Alternator (rear)				62201 2RS / C3	00298190 (77...)95	BB
Bomba d'água (dianteiro) / Bomba de agua (delantero) / Water pump (front)				30204 F	000720030204	TRB
				6206 C3	000625900209	BB
Bomba d'água (traseiro) / Bomba de agua (trasero) / Water pump (rear)				6203 / C3	000625900208	BB
Bomba hidráulica / Bomba hidráulica / Hydraulic pump				62204 2RS	0049819625	BB
Bomba injetora (dianteiro) / Bomba inyectora (delantero) / Injection pump (front)				30203 F	000720030203	TRB
Bomba injetora (traseiro) / Bomba inyectora (trasero) / Injection pump (rear)				30204 F	000720030204	TRB
Virabrequim / Cigüeñal / Crankshaft				6204 2RS / C3	000625406204	BB

	OUT	IN		Fersa®	Nº OEM	
---	-----	----	---	---------------	--------	---

MERCEDES BENZ

1620 OF * 1621 OF

Caixa de Mudanças / Caja de Cambios / Gearbox

Eixo intermediário (dianteiro) / Eje intermedio (delantero) / Intermediate shaft (front)			S 6-90/9,01 * 16 S-130 * S 6-90/9,01 + N 70/18 * S 6-90/6,98 * 8 S-1350 * S 6-1550/6,98 * S 6-1550 * S 6-105	F 15047		TRBS
Eixo Intermediário (dianteiro / traseiro) / Eje Intermedio (delantero / trasero) / Intermediate shaft (front / rear)			G 3/60-5/7,5 * G 3/50-5/8,5 * G 3/55-6/8,5 * G 3/50-5/8,5 * G 3/60-5/7,5 + NA 3/60-1B * G 3/50-5/8,5 + NA 3/60-1B * 16 S-1650 * S 6-1550/6,98 + ESI	30308 F		TRB
Eixo intermediário (traseiro) / Eje intermedio (trasero) / Intermediate shaft (rear)			S 6-90/9,01 * S 6-90/9,0 + N 70/18 * S 6-90/6,98 * S 6-1550/6,98 * S 6-1550 * S 6-105 * S 6-1550/6,98 + ESI	32309 F		TRB
			16 S-130 * 8 S-1350 * 16 S-1650	32310 F		TRB
Eixo primário / Eje primario / Primary shaft			S 6-90/9,0 + N 70/18 (ZF)	6208 N		BB
			G 3/50-5/8,5	F 19047		CRBS
			S 6-90/9,01 (ZF) * S 6-1550/6,98 * S 6-90/6,98 * S 6-1550	NUP 314 FMNR / C3		CRB
Eixo primário (dianteiro) / Eje primario (delantero) / Primary shaft (front)			G 3/60-5/7,5 * G 3/50-5/8,5 * G 3/60-5/7,5 + NA 3/60-1B * G 3/50-5/8,5 + NA 3/60-1B	QJ 212 FM		BB4PAC
Eixo primário (traseiro) / Eje primario (trasero) / Primary shaft (rear)			G 3/60-5/7,5 * G 3/50-5/8,5 * G 3/60-5/7,5 + NA 3/60-1B * G 3/50-5/8,5 + NA 3/60-1B	F 19011		CRBS
Eixo secundário / Eje secundario / Secondary shaft			4 S-120 GP; 4 S-120 GP + N 70/18 ...chassi 1235778	NUP 311 FMNR / C3		CRB
Eixo secundário (traseiro) / Eje secundario (trasero) / Secondary shaft (rear)			S 6-1550/6,98 * S 6-90/6,98	6314 C3		BB
			G 3/55-6/8,5	F 19046		CRBS
			S 6-1550 * S 6-105 * S 6-1550/6,98 + ESI	NUP 314 FMNR / C3		CRB
			G 3/60-5/7,5 * G 3/50-5/8,5 * G 3/60-5/7,5 + NA 3/60-1B	QJ 309 FM		BB4PAC
Tampa (traseiro) / Cubierta (trasero) / Cover (rear)			16 S-130 * 8 S-1350 * 16 S-1650	6218 C3		BB

Cardan / Cardan / Cardan



Suporte / Soporte / Support			L-1614	6210		BB
-----------------------------	--	--	--------	-------------	--	----

Direção / Dirección / Steering

Alavanca intermediária / Palanca intermedia / Intermediate lever			OF-1618/1620	30205 F		TRB
			OF-1618/1620	30206 F		TRB

Motor / Motor / Engine

Alternador (dianteiro) / Alternador (delantero) / Alternator (front)			OM 366 A/LA * OM 449 A/LA	6303 2RS / C3		BB
			OM 449 A * OM 366 * OM 366 A * OM 366 LA II/23	6403 2RS / C3		BB
Alternador (traseiro) / Alternador (trasero) / Alternator (rear)			OM 449 A/LA * OM 366 A/LA (28V e 35A/28 A;14V e 55 A-Bosch) * OM 366 LA II/23	62201 2RS / C3		BB

	OUT	IN		Fersa [®]	N° OEM	
---	-----	----	---	---------------------------	--------	---

MERCEDES BENZ

1620 OF * 1621 OF

Bomba d'água (dianteiro) / Bomba de agua (delantero) / Water pump (front)			OM 366 * OM 366 A/LA * OM 366 LAG	6206 C3		BB
Bomba d'água (traseiro) / Bomba de agua (traseiro) / Water pump (rear)			OM 366 * OM 366 A/LA * M 366 LAG	6203 / C3		BB
Virabrequim - ponta / Cigüeñal - punta / Crankshaft spindle			OM 366 A/LA * M 366 LAG	6204 2RS		BB

1714 OF * 1721 OF * 1722 OF

Caixa de Mudanças / Caja de Cambios / Gearbox

Corpo sincronizador (traseiro) / Cuerpo sincronizador (traseiro) / Synchronizer (rear)			4S-120 GP	6213 C3		BB
Eixo de acionamento / Eje de accionamiento / Drive shaft				NUP 2212 FMN		CRB
Eixo de saída (traseiro) / Eje de salida (traseiro) / Output shaft (rear)			G 3/50-5/8,5 + NA 3/60-1B * G 3/60-5/7,5 + NA 3/60-1B	6007 N		BB
			S 6-90/9.01 + N 70/1B	6208 N		BB
Eixo intermediário (dianteiro) / Eje intermedio (delantero) / Intermediate shaft (front)			S 6-90 * S 6-90/9,01 * S 6-90/9.01 + N 70/1B * 8S-1350	F 15047		TRBS
Eixo Intermediário (dianteiro / traseiro) / Eje Intermedio (delantero / traseiro) / Intermediate shaft (front / rear)				30308 F	0019813105 / 0019815005	TRB
			G 3/50-5/8,5 + NA 3/60-1B * G 3/60-5/7,5 * G 3/50-5/8,5 * G 3/55-6/8,5 * G 3/60-5/7,5 + NA 3/60-1B	30308 F		TRB
Eixo intermediário (traseiro) / Eje intermedio (traseiro) / Intermediate shaft (rear)				32309 F	0049811305	TRB
			8S-1350	32310 F		TRB
			S 6-90/9.01 + N 70/1B	6009 C3		BB
Eixo primário / Eje primario / Primary shaft			G 3/55-6/8,5	F 19047		CRBS
			S 6-90 * S 6-90/9.01 + N 70/1B	NUP 314 FMNR / C3		CRB
Eixo primário (dianteiro) / Eje primario (delantero) / Primary shaft (front)				QJ 212 FM	3459817627	BB4PAC
Eixo primário (traseiro) / Eje primario (traseiro) / Primary shaft (rear)			G 3/50-5/8,5 + NA 3/60-1B * G 3/50-5/8,5	F 19011		CRBS
Eixo principal (saída) / Eje principal (salida) / Main shaft (output)				NUP 310 FMN / C3		CRB
Eixo secundário / Eje secundario / Secondary shaft				F 19019	49815801	CRBS
Eixo secundário (traseiro) / Eje secundario (traseiro) / Secondary shaft (rear)			S 6-90	6314		BB
			S 6-90/9.01 + N 70/1B	6314 C3		BB
			G 3/55-6/8,5	F 19046		CRBS
			4S-120 GP	NUP 311 FMNR / C3		CRB
			G 3/50-5/8,5 + NA 3/60-1B * G 3/60-5/7,5; G 3/50	QJ 309 FM		BB4PAC
			QJ 309 FM	0009813105	BB4PAC	
Tampa (traseiro) / Cubierta (traseiro) / Cover (rear)			8S-1350	6218 C3		BB
Tomada de força / Toma de fuerza / Power take-off				6208 N	000625506208	BB

Eixo Dianteiro / Eje Delantero / Front Axle

Roda / Rueda / Wheel	•		AL 4/6 DS-6/43:7	32017 XF		TRB
		•		32310 F	0019817405	TRB
		•	AL 4/6 DS-6/43:7	33019 F		TRB
	•			33208 F	3849817605 / 0089810105	TRB

	OUT	IN		Fersa®	Nº OEM	
---	-----	----	---	---------------	--------	---

MERCEDES BENZ

1714 OF * 1721 OF * 1722 OF

Roda / Rueda / Wheel	•			33210 F	0039818305	TRB
		•	VL 3/7 D-5	33213 F		TRB
		•		33213 F	0089810005	TRB
		•		33214 F	0039815605 / 0039815205	TRB
	•			F 15051 C	0059813105	TRBS

Eixo Traseiro / Eje Trasero / Rear Axle

Roda / Rueda / Wheel	•		HL 7/021 D-10/3,77	33019 F		TRB
		•		33019 F	00298190 (77...)05 / 0039818605	TRB
		•		33020 F	0059818505	TRB
		•		33020 F	014 981 3205	TRB
		•	HL 7/021 D-10/3,77	33021 F		TRB
	•			33116 F	012 981 4005	TRB
	•			33117 F	0059818605	TRB
	•			33215 F	0029818905 / 0029818605	TRB

Motor / Motor / Engine

Alternador (dianteiro) / Alternador (delantero) / Alternator (front)				6303 ZZ / C3	000625900182	BB
				6303 ZZ / C3	000625900193	BB
			OM 366 * OM 366 A/LA (Bosch 14V 55 A) * OM 366 LA II/23	6403 2RS / C3		BB
Alternador (traseiro) / Alternador (trasero) / Alternator (rear)				62201 2RS / C3	00298190 (77...)95	BB
Bomba d'água (dianteiro) / Bomba de agua (delantero) / Water pump (front)				6206 C3	000625900209	BB
			OM 366 * OM 366 A/LA	6206 C3		BB
Bomba d'água (traseiro) / Bomba de agua (trasero) / Water pump (rear)			OM 366 * OM 366 A/LA	6203 / C3		BB
				6203 / C3	000625900208	BB
Bomba hidráulica / Bomba hidráulica / Hydraulic pump				62204 2RS	0049819625	BB
Bomba injetora (dianteiro) / Bomba inyectora (delantero) / Injection pump (front)				30203 F	000720030203	TRB
Bomba injetora (traseiro) / Bomba inyectora (trasero) / Injection pump (rear)				30204 F	000720030204	TRB
Virabrequim / Cigüeñal / Crankshaft				6204 2RS / C3	000625406204	BB
Virabrequim - ponta / Cigüeñal - punta / Crankshaft spindle			OM 366 * OM 366 A/LA * OM 366 LA II/23 * OM 449 LA	6204 2RS		BB

MBO 1017

Eixo Dianteiro / Eje Delantero / Front Axle

Roda / Rueda / Wheel	•			25877 / 25820		TRB
		•		JM 207049 / JM 207010		TRB

Eixo Traseiro / Eje Trasero / Rear Axle

Roda / Rueda / Wheel	•			33287 / 33462		TRB
		•		3982 / 3920	94630960	TRB

MBO 1018 44

Caixa de Mudanças / Caja de Cambios / Gearbox

			Fuller FS 6305 A No. Fuller 1313645 / 791943	25590 / 25522	B7T1201A/ E7HZ7K228A	TRB
			Fuller FS 6305 A No. Fuller 658981 / 660181	3782 / 3720	B5QM1216A/9N4222	TRB

	OUT	IN		Fersa®	Nº OEM	
---	-----	----	---	---------------	--------	---

MERCEDES BENZ

MBO 1018 44

			Fuller FS 6305 A No. Fuller 675250 / 742259	39590 / 39520	2986843	TRB
			Fuller FS 6305 A	31594 / 31520	477080	TRB
			Tremec FS 5005	M 804049 / M 804010		TRB
			Tremec FS 5005 No. Fuller 654166 / 791943	25590 / 25520		TRB
			Tremec FSM 5005	M 804049 / M 804010		TRB
			Tremec FSM 5005 No. Fuller 654166 / 791943	25590 / 25520		TRB

Eixo Dianteiro / Eje Delantero / Front Axle

Roda / Rueda / Wheel	•			25877 / 25820		TRB
		•		JM 207049 A / JM 207010		TRB

Eixo Traseiro / Eje Trasero / Rear Axle

Roda / Rueda / Wheel	•			39590 / 39520	2986843	TRB
		•		47686 / 47620	7EQH1238	TRB

MBO 1019 44 Boxer

Caixa de Mudanças / Caja de Cambios / Gearbox

			Fuller FS 6305 A No. Fuller 1313645 / 791943	25590 / 25522	B7T1201A/ E7HZ7K228A	TRB
			Fuller FS 6305 A No. Fuller 658981 / 660181	3782 / 3720	B5QM1216A/9N4222	TRB
			Fuller FS 6305 A No. Fuller 675250 / 742259	39590 / 39520	2986843	TRB
			Fuller FS 6305 A	31594 / 31520	477080	TRB
			Tremec FS 5005 No. Fuller 235417 / 235418	M 804049 / M 804010		TRB
			Tremec FS 5005 No. Fuller 654166 / 791943	25590 / 25520		TRB
			Tremec FSM 5005 No. Fuller 235417 / 235418	M 804049 / M 804010		TRB
			Tremec FSM 5005 No. Fuller 654166 / 791943	25590 / 25520		TRB

Eixo Dianteiro / Eje Delantero / Front Axle

Roda / Rueda / Wheel	•			25877 / 25820		TRB
		•		JM 207049 A / JM 207010		TRB

Eixo Traseiro / Eje Trasero / Rear Axle

Roda / Rueda / Wheel	•			39590 / 39520	2986843	TRB
		•		47686 / 47620	7EQH1238	TRB

MBO 1217

Caixa de Mudanças / Caja de Cambios / Gearbox

			Fuller FS 6305 A No. Fuller 1313645 / 791943	25590 / 25522	B7T1201A/ E7HZ7K228A	TRB
			Fuller FS 6305 A No. Fuller 658981 / 660181	3782 / 3720	B5QM1216A/9N4222	TRB
			Fuller FS 6305 A No. Fuller 675250 / 742259	39590 / 39520	2986843	TRB
			Fuller FS 6305 A No. Fuller 710787	31594 / 31520	477080	TRB

Eixo Dianteiro / Eje Delantero / Front Axle

Roda / Rueda / Wheel	•			3782 / 3720	B5QM1216A/9N4222	TRB
		•		HM 212049 / HM 212011		TRB

	OUT	IN		Fersa®	N° OEM	
---	-----	----	---	---------------	--------	---

MERCEDES BENZ

MBO 1217

Roda / Rueda / Wheel	•			3782 / 3720	B5QM1216A/9N4222	TRB
		•		HM 212049 / HM 212011		TRB

Eixo Traseiro / Eje Trasero / Rear Axle

Roda / Rueda / Wheel	•			39590 / 39520	2986843	TRB
		•		47686 / 47620	7EQH1238	TRB
	•			39590 / 39520	2986843	TRB
		•		47686 / 47620	7EQH1238	TRB

MBO 1219 52 Boxer

Caixa de Mudanças / Caja de Cambios / Gearbox

			Fuller FS5406	25590 / 25522	B7T1201A/ E7HZ7K228A	TRB
			Fuller FS5406	39590 / 39520	2986843	TRB
			Fuller FS5406	31594 / 31520	477080	TRB
			Fuller FS5406	3782 / 3720	B5QM1216A/9N4222	TRB
			Tremec FS 5005 No. Fuller 235417 / 235418	M 804049 / M 804010		TRB
			Tremec FS 5005 No. Fuller 654166 / 791943	25590 / 25520		TRB
			Tremec FSM 5005	M 804049 / M 804010		TRB
			Tremec FSM 5005 No. Fuller 654166 / 791943	25590 / 25520		TRB

Eixo Dianteiro / Eje Delantero / Front Axle

Roda / Rueda / Wheel	•			3782 / 3720	B5QM1216A/9N4222	TRB
		•		HM 212049 / HM 212011		TRB

Eixo Traseiro / Eje Trasero / Rear Axle

Roda / Rueda / Wheel	•			39590 / 39520	2986843	TRB
		•		47686 / 47620	7EQH1238	TRB

MBO 1417

Eixo Dianteiro / Eje Delantero / Front Axle

Roda / Rueda / Wheel	•			3782 / 3720	B5QM1216A/9N4222	TRB
		•		HM 212049 / HM 212011		TRB

Eixo Traseiro / Eje Trasero / Rear Axle

Roda / Rueda / Wheel	•			39590 / 39520	2986843	TRB
		•		47686 / 47620	7EQH1238	TRB

MBO 1418 60

Caixa de Mudanças / Caja de Cambios / Gearbox

			Fuller FS5406	25590 / 25522	B7T1201A/ E7HZ7K228A	TRB
			Fuller FS5406	39590 / 39520	2986843	TRB
			Fuller FS5406	31594 / 31520	477080	TRB
			Fuller FS5406	3782 / 3720	B5QM1216A/9N4222	TRB

Eixo Dianteiro / Eje Delantero / Front Axle

Roda / Rueda / Wheel	•			3782 / 3720	B5QM1216A/9N4222	TRB
		•		HM 212049 / HM 212011		TRB

Eixo Traseiro / Eje Trasero / Rear Axle

Roda / Rueda / Wheel	•			39590 / 39520	2986843	TRB
		•		47686 / 47620	7EQH1238	TRB

	OUT	IN		Fersa [®]	N° OEM	
---	-----	----	---	---------------------------	--------	---

MERCEDES BENZ

MBO 1419 60 Boxer

Caixa de Mudanças / Caja de Cambios / Gearbox

			Fuller FS5406	25590 / 25522	B7T1201A/ E7HZ7K228A	TRB
			Fuller FS5406	39590 / 39520	2986843	TRB
			Fuller FS5406	31594 / 31520	477080	TRB
			Fuller FS5406	3782 / 3720	B5QM1216A/9N4222	TRB

Eixo Dianteiro / Eje Delantero / Front Axle

Roda / Rueda / Wheel	•			3782 / 3720	B5QM1216A/9N4222	TRB
		•		HM 212049 / HM 212011		TRB

MBO 1621

Eixo Dianteiro / Eje Delantero / Front Axle

Roda / Rueda / Wheel	•			3782 / 3720	B5QM1216A/9N4222	TRB
		•		HM 212049 / HM 212011		TRB

Eixo Traseiro / Eje Trasero / Rear Axle

Roda / Rueda / Wheel	•			580 / 572	600704011	TRB
		•		594A / 592A	183704	TRB

OF 1313 * OF 1314 * OF 1315 * OF 1316 * OF 1317 * OF 1318 51

Eixo Dianteiro / Eje Delantero / Front Axle

Roda / Rueda / Wheel	•			3782 / 3720	B5QM1216A/9N4222	TRB
		•		HM 212049 / HM 212011		TRB

Eixo Traseiro / Eje Trasero / Rear Axle

Roda / Rueda / Wheel	•			39590 / 39520	2986843	TRB
		•		47686 / 47620	7EQH1238	TRB
Diferencial / Diferencial / Differential				32018 XF	004 981 43 05	TRB
				32020 XF	001 981 64 05	TRB
				F 15082	001 981 99 05	TRBS
				F 15159	006 981 35 05	TRBS

OMC 141851 * OMC 141860

Eixo Dianteiro / Eje Delantero / Front Axle

Roda / Rueda / Wheel	•			3782 / 3720	B5QM1216A/9N4222	TRB
		•		HM 212049 / HM 212011		TRB

Eixo Traseiro / Eje Trasero / Rear Axle

Roda / Rueda / Wheel	•			47686 / 47620	7EQH1238	TRB
		•		39590 / 39520	2986843	TRB

OMC 1419 51

Caixa de Mudanças / Caja de Cambios / Gearbox

			Fuller FS5406	25590 / 25522	B7T1201A/ E7HZ7K228A	TRB
			Fuller FS5406	39590 / 39520	2986843	TRB
			Fuller FS5406 No. Fuller 710787	31594 / 31520	477080	TRB
			Fuller FS5406	3782 / 3720	B5QM1216A/9N4222	TRB
			Tremec FS 5005 No. Fuller 235417 / 235418	M 804049 / M 804010		TRB
			Tremec FS 5005 No. Fuller 654166 / 791943	25590 / 25520		TRB
			Tremec FSM 5005 No. Fuller 235417 / 235418	M 804049 / M 804010		TRB

	OUT	IN		Fersa®	N° OEM	
---	-----	----	---	---------------	--------	---

MERCEDES BENZ

OMC 1419 51

			Tremec FSM 5005 No. Fuller 654166 / 791943	25590 / 25520		TRB
--	--	--	---	----------------------	--	-----

Eixo Dianteiro / Eje Delantero / Front Axle

Roda / Rueda / Wheel	•			3782 / 3720	B5QM1216A/9N4222	TRB
		•		HM 212049 / HM 212011		TRB

Eixo Traseiro / Eje Trasero / Rear Axle

Roda / Rueda / Wheel	•			39590 / 39520	2986843	TRB
		•		47686 / 47620	7EQH1238	TRB

OMC 1421 51

Caixa de Mudanças / Caja de Cambios / Gearbox

			Fuller FS 6406 A No. Fuller 711123 / 5202047	45284 / 45220		TRB
			Fuller FS 6406 A No. Fuller 1313645 / 791943	25590 / 25522	B7T1201A/ E7HZ7K228A	TRB
			Fuller FS 6406 A No. Fuller 658981 / 660181	3782 / 3720	B5QM1216A/9N4222	TRB
			Fuller FS 6406 A No. Fuller 675250 / 742259	39590 / 39520	2986843	TRB
			Fuller FS 6406 A	31594 / 31520	477080	TRB

Eixo Traseiro / Eje Trasero / Rear Axle

Diferencial / Diferencial / Differential				F 19015	3459817501	CRBS
--	--	--	--	----------------	------------	------

Eixo Dianteiro / Eje Delantero / Front Axle

Roda / Rueda / Wheel	•			3782 / 3720	B5QM1216A/9N4222	TRB
		•		HM 212049 / HM 212011		TRB
	•			3782 / 3720	B5QM1216A/9N4222	TRB
		•		HM 212049 / HM 212011		TRB

Eixo Traseiro / Eje Trasero / Rear Axle

Roda / Rueda / Wheel	•			580 / 572	600704011	TRB
		•		594A / 592A	183704	TRB

OMC 1425 51 Allegro

Caixa de Mudanças / Caja de Cambios / Gearbox

			Fuller FS 8406 A No. Fuller 1313645 / 791943	25590 / 25522	B7T1201A/ E7HZ7K228A	TRB
			Fuller FS 8406 A No. Fuller 658981 / 660181	3782 / 3720	B5QM1216A/9N4222	TRB
			Fuller FS 8406 A No. Fuller 675250 / 742259	39590 / 39520	2986843	TRB
			Fuller FS 8406 A	31594 / 31520	477080	TRB

Eixo Traseiro / Eje Trasero / Rear Axle

Diferencial / Diferencial / Differential				F 19015	3459817501	CRBS
--	--	--	--	----------------	------------	------

Eixo Dianteiro / Eje Delantero / Front Axle

Roda / Rueda / Wheel	•			3782 / 3720	B5QM1216A/9N4222	TRB
		•		HM 212049 / HM 212011		TRB

Eixo Traseiro / Eje Trasero / Rear Axle

Roda / Rueda / Wheel	•			580 / 572	600704011	TRB
		•		594A / 592A	183704	TRB

	OUT	IN		Fersa [®]	Nº OEM	
---	-----	----	---	---------------------------	--------	---

MERCEDES BENZ (CA)

LO 1417 59

Eixo Dianteiro / Eje Delantero / Front Axle

Roda / Rueda / Wheel	•			3782 / 3720	B5QM1216A/9N4222	TRB
		•		HM 212049 / HM 212011		TRB

Eixo Traseiro / Eje Trasero / Rear Axle

Roda / Rueda / Wheel	•			39590 / 39520	2986843	TRB
		•		47686 / 47620	7EQH1238	TRB

LO 709 * LO 710 * LO 712

Caixa de Transferência / Caja de Transferencia / Transfer Case

				33210 F	003 981 83 05	TRB
--	--	--	--	---------	---------------	-----

Caixa de Mudanças / Caja de Cambios / Gearbox

				30306 F	001 981 57 05	TRB
				32208 F	LA5113	TRB
				32210 F	LA5115	TRB
				33011 F	005 981 44 05	TRB
				32208 F	LA5113	TRB
				32210 F	LA5115	TRB
				30306 F	001 981 57 05	TRB
				32208 F	LA5113	TRB
			GMC6-100, 6-150, 12-170, 14-190, 15-190	32210 F	LA5115	TRB
				30308 F		TRB

Eixo Traseiro / Eje Trasero / Rear Axle

Diferencial / Diferencial / Differential				32017 XF	184623	TRB
--	--	--	--	----------	--------	-----

Eixo Dianteiro / Eje Delantero / Front Axle

Roda / Rueda / Wheel				33109 F	003 981 16 05	TRB
				33205 F	006 981 58 05	TRB
				32306 F	3129810205	TRB
				33109 F	003 981 16 05	TRB
				33205 F	006 981 58 05	TRB
				32306 F	3129810205	TRB

Eixo Dianteiro e Traseiro / Eje Delantero y Trasero / Front and Rear Axle

Roda / Rueda / Wheel				33111 F	000 980 75 02	TRB
				33111 F	000 980 75 02	TRB

Eixo Traseiro / Eje Trasero / Rear Axle

Roda / Rueda / Wheel				33895 / 33822	002 981 05 05	TRB
----------------------	--	--	--	---------------	---------------	-----

LO 914

Eixo Dianteiro / Eje Delantero / Front Axle

Roda / Rueda / Wheel				33109 F	003 981 16 05	TRB
				33205 F	006 981 58 05	TRB
				32306 F	3129810205	TRB

Eixo Dianteiro e Traseiro / Eje Delantero y Trasero / Front and Rear Axle

Roda / Rueda / Wheel				33111 F	000 980 75 02	TRB
----------------------	--	--	--	---------	---------------	-----

OF 1111 * OF 1113 * OF 1114 * OF 1115 * OF 1116 * OF 1117 * OF 1118

Eixo Dianteiro / Eje Delantero / Front Axle

Roda / Rueda / Wheel				30312 F	001 981 97 05	TRB
				497 / 492A	000 981 61 05	TRB

	OUT	IN		Fersa®	N° OEM	
---	-----	----	---	---------------	--------	---

MERCEDES BENZ (CA)

OF 1215 * OF 1217

Caixa de Mudanças / Caja de Cambios / Gearbox

				32208 F	LA5113	TRB
				32210 F	LA5115	TRB

Eixo Traseiro / Eje Trasero / Rear Axle

Diferencial / Diferencial / Differential				32018 XF	004 981 43 05	TRB
				32020 XF	001 981 64 05	TRB
				F 15082	001 981 99 05	TRBS
				F 15159	006 981 35 05	TRBS

Eixo Traseiro / Eje Trasero / Rear Axle

Roda / Rueda / Wheel		•		33020 F	005 981 84 05	TRB
----------------------	--	---	--	----------------	---------------	-----

OF 1320

Eixo Traseiro / Eje Trasero / Rear Axle

Diferencial / Diferencial / Differential				32018 XF	004 981 43 05	TRB
				32020 XF	001 981 64 05	TRB
				F 15082	001 981 99 05	TRBS
				F 15159	006 981 35 05	TRBS

Eixo Dianteiro / Eje Delantero / Front Axle

Roda / Rueda / Wheel				497 / 492A	000 981 61 05	TRB
----------------------	--	--	--	-------------------	---------------	-----

OF 1416 * OF 1417 * OF 1418 * OF 1419 * OF 1420 * OF 1421

Caixa de Mudanças / Caja de Cambios / Gearbox

				32208 F	LA5113	TRB
--	--	--	--	----------------	--------	-----

Eixo Traseiro / Eje Trasero / Rear Axle

Diferencial / Diferencial / Differential				32017 XF	184623	TRB
				32018 XF	004 981 43 05	TRB
				32020 XF	001 981 64 05	TRB
				F 15082	001 981 99 05	TRBS

Eixo Dianteiro / Eje Delantero / Front Axle

Roda / Rueda / Wheel	•			3782 / 3720	B5QM1216A/9N4222	TRB
		•		HM 212049 / HM 212011		TRB

Eixo Traseiro / Eje Trasero / Rear Axle

Roda / Rueda / Wheel	•			39590 / 39520	2986843	TRB
		•		47686 / 47620	7EQH1238	TRB

OF 1513 * OF 1514

Eixo Traseiro / Eje Trasero / Rear Axle

Diferencial / Diferencial / Differential				H 715345 / H 715311	181342	TRB
--	--	--	--	----------------------------	--------	-----

OF 1517 * OF 1518 * OF 1519 * OF 1520 * OF 1521 * OF 1524 * OF 1525

Eixo Traseiro / Eje Trasero / Rear Axle

Diferencial / Diferencial / Differential				32017 XF	184623	TRB
				32018 XF	004 981 43 05	TRB
				32020 XF	001 981 64 05	TRB
				F 15082	001 981 99 05	TRBS
				F 15159	006 981 35 05	TRBS
				H 715345 / H 715311	181342	TRB

Eixo Dianteiro / Eje Delantero / Front Axle

Roda / Rueda / Wheel	•			32310 F	001 981 74 05	TRB
		•		F 15051 C	005 981 30 05	TRBS

	OUT	IN		Fersa [®]	Nº OEM	
---	-----	----	---	---------------------------	--------	---

MERCEDES BENZ (CA)

OF 1517 * OF 1518 * OF 1519 * OF 1520 * OF 1521 * OF 1524 * OF 1525

Eixo Traseiro / Eje Trasero / Rear Axle

Roda / Rueda / Wheel		•	OF1618 * OF1620 * OF1621 * OF1625 * OF1628 * OF1630 * OF1635 * OF1636	32218 F	072 003 22 18	TRB
----------------------	--	---	--	----------------	---------------	-----

OF 1618 * OF 1620 * OF 1621 * OF 1625 * OF 1628 * OF 1630 * OF 1635 * OF 1636

Caixa de Transferência / Caja de Transferencia / Transfer Case

			OF1714 * OF1718 * OF1721 * OF1725	33210 F	003 981 83 05	TRB
--	--	--	--------------------------------------	----------------	---------------	-----

Eixo Traseiro / Eje Trasero / Rear Axle

Diferencial / Diferencial / Differential				32017 XF	184623	TRB
				32018 XF	004 981 43 05	TRB
				32020 XF	001 981 64 05	TRB
				F 15082	001 981 99 05	TRBS
				F 15159	006 981 35 05	TRBS

Eixo Dianteiro / Eje Delantero / Front Axle

Roda / Rueda / Wheel	•			32310 F	001 981 74 05	TRB
		•		F 15051 C	005 981 30 05	TRBS

Eixo Traseiro / Eje Trasero / Rear Axle

Roda / Rueda / Wheel		•		32218 F	072 003 22 18	TRB
----------------------	--	---	--	----------------	---------------	-----

OF 1714 * OF 1718 * OF 1721 * OF 1725

Caixa de Mudanças / Caja de Cambios / Gearbox

				32210 F	LA5115	TRB
--	--	--	--	----------------	--------	-----



Eixo Traseiro / Eje Trasero / Rear Axle

Diferencial / Diferencial / Differential				32017 XF	184623	TRB
				32018 XF	004 981 43 05	TRB
				32020 XF	001 981 64 05	TRB
				F 15082	001 981 99 05	TRBS
				F 15159	006 981 35 05	TRBS

Eixo Dianteiro / Eje Delantero / Front Axle

Roda / Rueda / Wheel				F 15051 C	005 981 30 05	TRBS
	•			33213 F	006 981 63 05	TRB
	•			32310 F	001 981 74 05	TRB
				33109 F	003 981 16 05	TRB
				33205 F	006 981 58 05	TRB



	OUT	IN		Fersa [®]	N° OEM	
---	-----	----	---	---------------------------	--------	---

RANDON

RK 425 B

Caixa de Mudanças / Caja de Cambios / Gearbox

Eixo intermediário / Eje intermedio / Intermediate shaft				F 19010		CRB
				F 19039		CRB

TODOS / TODOS / ALL

Eixo / Eje / Rear

Roda / Rueda / Wheel				F 15156		TRBS
	•			32216 F		TRB
		•		32218 F		TRB

SUDISA

EA11ED

Eixo / Eje / Axle

Roda / Rueda / Wheel	•			580 / 572	39811405	TRB
		•		594 A / 592 A	183704	TRB

EA12EF

Eixo / Eje / Axle

Roda / Rueda / Wheel		•		HM 518445 / HM 518410		TRB
----------------------	--	---	--	------------------------------	--	-----

EA12TD

Eixo / Eje / Axle

Roda / Rueda / Wheel	•			580 / 572	39811405	TRB
		•		594 A / 592 A	39811405	TRB

EA12TF

Eixo / Eje / Axle

Roda / Rueda / Wheel		•		HM 518445 / HM 518410		TRB
----------------------	--	---	--	------------------------------	--	-----

EA4

Eixo / Eje / Axle

Roda / Rueda / Wheel		•		387 A / 382 A		TRB
	•			LM 104949 / LM 104911		TRB

EA9EM

Eixo / Eje / Axle

Roda / Rueda / Wheel	•			HM 212049 / HM 212011		TRB
		•		HM 218248 / HM 218210	291060	TRB

EA9TM

Eixo / Eje / Axle

Roda / Rueda / Wheel	•			HM 212049 / HM 212011		TRB
		•		HM 218248 / HM 218210	291060	TRB

EE4 * EH4

Eixo / Eje / Axle

Roda / Rueda / Wheel	•			368 S / 362		TRB
		•		388 A / 382		TRB
		•		45291 / 45220		TRB
	•			LM 104949 / LM 104911		TRB



A large, empty area of the page filled with horizontal blue lines, intended for writing or drawing.



09

Bearings for Truck Applications

Rolamentos para Aplicações de Caminhão
Rodamientos para Aplicaciones de Camión





	OUT	IN		Fersa®	N° OEM	
---	-----	----	---	---------------	--------	---

CHRYSLER

D-600 * PD-600

Caixa de Mudanças / Caja de Cambios / Gearbox

		Tremec FS 5005 No. Fuller 235417 / 235418	M 804049 / M 804010		TRB
		Tremec FS 5005 No. Fuller 654166 / 791943	25590 / 25520	9414069	TRB
		Tremec FSM 5005 No. Fuller 235417 / 235418	M 804049 / M 804010		TRB
		Tremec FSM 5005 No. Fuller 654166 / 791943	25590 / 25520	9414069	TRB

Eixo Traseiro / Eje Trasero / Rear Axle

Diferencial (dir.) / Diferencial (der.) / Differential (right)		15,000 lb.	33275 / 33472		TRB
		17,000 lb.	497 / 493	620244	TRB
Diferencial - (dir./esq.) / Diferencial - (der./izq.) / Differential (right/left)		Rockwell 18,500 lb.	496 / 493		TRB
		15,000 lb.	498 / 493		TRB
Diferencial - (esq.) / Diferencial - (izq.) / Differential (left)		17,000 lb.	56425 / 56650		TRB
		15,000 lb.	HM 903249 / HM 903210	931482	TRB
Diferencial - pinhão (cabeza - cola) / Diferencial - piñón (cabeza / cola) / Differential - pinion head rear		17,000 lb.	55200 C / 55437		TRB
			72200 C / 72487		TRB
		Rockwell 18,500 lb.	72188 C / 72487		TRB
Diferencial - pinhão cola / Diferencial - piñón cola / Differential - pinion rear		Rockwell 18,500 lb.	72188 C / 72487		TRB

Eixo Dianteiro / Eje Delantero / Front Axle

Roda / Rueda / Wheel	•	FF931, 12,000 lb.	3782 / 3720	807949	TRB	
		•	FF-931, 12,000 lb.	HM 212049 / HM 212011	TRB	
	•	5,000 lb.	14116 / 14276		TRB	
		•	5,000 lb.	25590 / 25520	9414069	TRB
	•	7,000 lb.	2780 / 2720		TRB	
		•	7,000 lb.	45284 / 45220	2986840	TRB
	•	9,000 lb.	3585 / 3525		TRB	
		•	9,000 lb.	39581 / 39520		TRB

Eixo Traseiro / Eje Trasero / Rear Axle

Roda / Rueda / Wheel	•	Eaton 15,000 lb.	3982 / 3920	2TA/598313	TRB
		•	Eaton 15,000 lb.	33287 / 33462	TRB
	•	Eaton 17,000 lb.	39590 / 39520	1240A / 2986843	TRB
		•	Eaton 17,000 lb.	47686 / 47620	

Ram 6500

Caixa de Mudanças / Caja de Cambios / Gearbox

		Tremec FS 5005 No. Fuller 235417	M 804049 / M 804010		TRB
		Tremec FS 5005 No. Fuller 235418	M 804049 / M 804010		TRB
		Tremec FS 5005 No. Fuller 654166 / 791943	25590 / 25520	9414069	TRB
		Tremec FSM 5005 No. Fuller 235417 / 235418	M 804049 / M 804010		TRB
		Tremec FSM 5005 No. Fuller 654166 / 791943	25590 / 25520	9414069	TRB



DINA

300 HTQ Serie

Eixo Traseiro / Eje Trasero / Rear Axle

Diferencial (dir.) / Diferencial (der.) / Differential (right)				42381 / 42584	073 5371114	TRB
Diferencial - (esq.) / Diferencial - (izq.) / Differential (left)				496 / 493		TRB
Diferencial - pinhão cabeça / Diferencial - piñón cabeza / Differential - pinion head				78215 C / 78551		TRB
Diferencial - pinhão cola / Diferencial - piñón cola / Differential - pinion (rear)				72212 C / 72487		TRB
Roda / Rueda / Wheel	•		DCP331	39590 / 39520	1240A / 2986843	TRB
		•	DCP331	47686 / 47620		TRB
	•		DCP351	580 / 572	39811405	TRB
		•	DCP351	594 A / 592 A	183704	TRB

Eixo Dianteiro / Eje Delantero / Front Axle

Roda / Rueda / Wheel	•			3782 / 3720	807949	TRB
		•		HM 212049 / HM 212011		TRB

400 Serie

Eixo Traseiro / Eje Trasero / Rear Axle

Diferencial (dir.) / Diferencial (der.) / Differential (right)				33275 / 33472		TRB
			Eaton 19055T	497 / 493	81.93420.0195	TRB
Diferencial - (esq.) / Diferencial - (izq.) / Differential (left)				498 / 493		TRB
				56425 / 56650		TRB
Diferencial - pinhão cabeça / Diferencial - piñón cabeza / Differential - pinion head				72200 C / 72487		TRB
Diferencial - pinhão (cabeza - cola) / Diferencial - piñón (cabeza / cola) / Differential - pinion head (rear)				55200 C / 55437		TRB
Diferencial - pinhão (cabeza - cola) / Diferencial - piñón (cabeza / cola) / Differential - pinion head (rear)				HM 903249 / HM 903210	931482	TRB
Roda / Rueda / Wheel	•			JM 207049 A / JM 207010		TRB
		•		495 A / 493		TRB

Eixo Dianteiro / Eje Delantero / Front Axle

Roda / Rueda / Wheel	•			25880 / 25820		TRB
		•		45284 / 45220	2986840	TRB

500 HTQ Serie

Eixo Dianteiro / Eje Delantero / Front Axle

Roda / Rueda / Wheel	•			3782 / 3720	807949	TRB
		•		HM 212049 / HM 212011		TRB

Eixo Traseiro / Eje Trasero / Rear Axle

Roda / Rueda / Wheel	•			580 / 572	39811405	TRB
		•		594 A / 592 A	183704	TRB

531 K * 532 J

Caixa de Mudanças / Caja de Cambios / Gearbox

			Tremec CL559 No. Fuller 235417 / 235418	M 804049 / M 804010		TRB
			Tremec CL559 No. Fuller 654166 / 791943	25590 / 25520	9414069	TRB

	OUT	IN		Fersa®	Nº OEM	
---	-----	----	---	---------------	--------	---

DINA

531 K * 532 J

Eixo Traseiro / Eje Trasero / Rear Axle

Diferencial (dir.) / Diferencial (der.) / Differential (right)				3994 / 3920	06.32499.0145	TRB
				495 A / 493		TRB
				497 / 493	81.93420.0195	TRB
Diferencial - (esq.) / Diferencial - (izq.) / Differential (left)				42381 / 42584	073 5371114	TRB
				56425 / 56650		TRB
			Meritor, Dana 38,000 lb.	567 / 563	354821	TRB
Diferencial - pinhão cabeça / Diferencial - piñón cabeza / Differential - pinion head				HM 903249 / HM 903210	931482	TRB
Diferencial - pinhão (cabeza - cola) / Diferencial - piñón (cabeza / cola) / Differential - pinion head (rear)				55200 C / 55437		TRB
Roda / Rueda / Wheel	•			39590 / 39520	1240A / 2986843	TRB
		•		47686 / 47620		TRB

Eixo Dianteiro / Eje Delantero / Front Axle

Roda / Rueda / Wheel	•			3196 / 3120		TRB
		•		33895 / 33821		TRB

551

Direção / Dirección / Steering

Perno de direção / Perno de dirección / Pintle direction				T 163	DIHA 3123 B2A	TRBT
--	--	--	--	--------------	---------------	------

Eixo Traseiro / Eje Trasero / Rear Axle

Roda / Rueda / Wheel	•			580 / 572	39811405	TRB
		•	Spicer / 550886 / 55117576	594 A / 592 A	183704	TRB
	•			39590 / 39520	1240A / 2986843	TRB
		•		47686 / 47620		TRB

Eixo Dianteiro / Eje Delantero / Front Axle

Roda / Rueda / Wheel	•			3782 / 3720	807949	TRB
		•		HM 212049 / HM 212011		TRB

552 Q

Eixo Traseiro / Eje Trasero / Rear Axle

Roda / Rueda / Wheel	•			39590 / 39520	1240A / 2986843	TRB
		•		47686 / 47620		TRB

Eixo Dianteiro / Eje Delantero / Front Axle

Roda / Rueda / Wheel	•			3782 / 3720	807949	TRB
		•		HM 212047 / HM 212011	C4TA1215B	TRB

553 19072 * 555 19070 * 661 25070 * 743 00300

Eixo Traseiro / Eje Trasero / Rear Axle

Roda / Rueda / Wheel	•			39590 / 39520	1240A / 2986843	TRB
		•		47686 / 47620		TRB

Eixo Dianteiro / Eje Delantero / Front Axle

Roda / Rueda / Wheel	•			3782 / 3720	807949	TRB
		•		HM 212049 / HM 212011		TRB

	OUT	IN		Fersa®	N° OEM	
---	-----	----	---	---------------	--------	---

DINA

604 G1 * 604 G3 * 604 L1 * 604 L5 * 631 K1 * 631 K3 * 661 C1 * 661 G1 * 661 G2 * 661 G3

Eixo Traseiro / Eje Trasero / Rear Axle

Diferencial - flecha de entrada / Diferencial - flecha de entrada / Differential - input shaft			34,000 * 38,000 lb.	JM 207049 / JM 207010		TRB
Diferencial - flecha de saída / Diferencial - flecha de salida / Differential - output shaft			34,000 * 38,000 lb.	34274 / 34492 A		TRB
Diferencial (dir.) / Diferencial (der.) / Differential (right)			Eaton 20,000 lb.	42346 / 42584		TRB
Diferencial - (dir.) 2a velocidade / Diferencial - derecho 2a velocidad / Differential - 2a speed (right)			Eaton 18,500 lb.	495 A / 493		TRB
Diferencial - (dir./esq.) / Diferencial - (der./izq.) / Differential (right / left)				56425 / 56650		TRB
			Meritor * Dana 38,000 lb.	567 / 563	354821	TRB
			38,000 lb.	497 / 493	81.93420.0195	TRB
Diferencial - (esq.) / Diferencial - (izq.) / Differential (left)			Eaton 20,000 lb.	68450 / 68712		TRB
Diferencial - pinhão (cabeza - cola) / Diferencial - piñón (cabeza / cola) / Differential - pinion head (rear)			34,000 * 38,000 lb.	55200 C / 55437		TRB
			34,000 * 38,000 lb.	72200 C / 72487		TRB
			Eaton 18,500 lb.	55200 C / 55437		TRB
			Eaton 20,000 lb.	72212 C / 72487		TRB
Roda / Rueda / Wheel	•		78...00	39590 / 39520	1240A / 2986843	TRB
		•	78...00	47686 / 47620		TRB

Direção / Dirección / Steering

Perno de direção / Perno de dirección / Pintle direction				T 163	DIHA 3123 B2A	TRBT
Eixo Dianteiro / Eje Delantero / Front Axle						
Roda / Rueda / Wheel	•		78...91	3782 / 3720	807949	TRB
		•	78...91	HM 212047 / HM 212011	C4TA1215B	TRB
	•		...00	3782 / 3720	807949	TRB
		•	...00	HM 212049 / HM 212011		TRB

650 19570 Cab Over

Eixo Traseiro / Eje Trasero / Rear Axle

Roda / Rueda / Wheel	•			39590 / 39520	1240A / 2986843	TRB
		•		47686 / 47620		TRB

Eixo Dianteiro / Eje Delantero / Front Axle

Roda / Rueda / Wheel	•			3782 / 3720	807949	TRB
		•		HM 212049 / HM 212011		TRB

702 * 707

Eixo Traseiro / Eje Trasero / Rear Axle

Roda / Rueda / Wheel	•			580 / 572	39811405	TRB
		•		598 A / 592 A		TRB

Eixo Dianteiro / Eje Delantero / Front Axle

Roda / Rueda / Wheel	•			3782 / 3720	807949	TRB
		•		HM 212044 / HM 212011		TRB

	OUT	IN		Fersa®	Nº OEM	
---	-----	----	---	---------------	--------	---

DINA

743

Eixo Traseiro / Eje Trasero / Rear Axle

Diferencial - (dir./esq.) / Diferencial - (der./izq.) / Differential (right / left)			Tandem	496 / 493		TRB
Diferencial - pinhão (cabeza - cola) / Diferencial - piñón (cabeza / cola) / Differential - pinion head (rear)			Tandem	72200 C / 72487		TRB
Diferencial - pinhão cola / Diferencial - piñón cola / Differential - pinion (rear)			Tandem	72188 C / 72487		TRB
Roda / Rueda / Wheel	•			580 / 572	39811405	TRB
		•	Spicer 550886	598 A / 592 A		TRB

Eixo Dianteiro / Eje Delantero / Front Axle

Roda / Rueda / Wheel	•			3782 / 3720	807949	TRB
		•		HM 212049 / HM 212011		TRB

751 Multi Torque

Eixo Traseiro / Eje Trasero / Rear Axle

Diferencial - eixo de entrada / Diferencial - eje de entrada / Differential - input shaft			Rockwell SSHD 44,000 / 46,000 lb.	JH 211749 / JH 211710	183844	TRB
			Rockwell SSHD 44,000 / 46,000 lb.	LM 104949 / LM 104910		TRB
Diferencial - interdiferencial / Diferencial - interdiferencial / Differential - interdifferential			Rockwell SSHD 44,000 / 46,000 lb.	JLM 714149 / JLM 714110	183345	TRB
Diferencial - (dir./esq.) / Diferencial - (der./izq.) / Differential (right / left)			Rockwell SSHD 44,000 / 46,000 lb.	47890 / 47820	181608 / 590762	TRB
Diferencial - nariz pinhão / Diferencial - nariz piñón / Differential - pinion			Rockwell SSHD 44,000 / 46,000 lb.	F 19034		CRBS
Diferencial - pinhão (cabeza - cola) / Diferencial - piñón (cabeza / cola) / Differential - pinion head (rear)			Rockwell SSHD 44,000 / 46,000 lb.	H 715343 / H 715311	500588901	TRB
Diferencial - pinhão cola / Diferencial - piñón cola / Differential - pinion (rear)			Rockwell SSHD 44,000 / 46,000 lb.	65237 / 65500	32230	TRB
Roda / Rueda / Wheel	•			580 / 572	39811405	TRB
		•		594 A / 592 A	183704	TRB

Direção / Dirección / Steering

Perno de direção / Perno de dirección / Pintle direction				T 182	DIHA 3123 A2A	TRBT
--	--	--	--	--------------	---------------	------

Eixo Dianteiro / Eje Delantero / Front Axle

Roda / Rueda / Wheel	•		86...91	3782 / 3720	807949	TRB
		•	86...91	HM 212047 / HM 212011	C4TA1215B	TRB
	•		...00	3782 / 3720	807949	TRB
		•	...00	HM 212049 / HM 212011		TRB

761

Eixo Traseiro / Eje Trasero / Rear Axle

Diferencial - flecha intermediária (entrada) / Diferencial - flecha intermedia (entrada) / Differential - intermediate shaft (input)			Rockwell SQHD	29675 / 29630		TRB
Diferencial - flecha intermediária (saída) / Diferencial - flecha intermedia (salida) / Differential - intermediate shaft (output)				LM 603049 / LM 603011		TRB
			Rockwell SQHD	31597 / 31520		TRB
Diferencial - flecha transversal / Diferencial - flecha transversal / Differential - transversal shaft			Rockwell SQDD	66225 / 66462		TRB

	OUT	IN		Fersa®	N° OEM	
---	-----	----	---	---------------	--------	---

DINA

761

Diferencial - (dir./esq.) / Diferencial - (der./izq.) / Differential (right / left)			Rockwell SQDD	581 / 572		TRB
			Rockwell SQDD	496 / 493		TRB
Diferencial - pinhão cabeça / Diferencial - piñón cabeça / Differential - pinion head			Rockwell SQDD	42381 / 42584	073 5371114	TRB
			Rockwell SQHD	72188 C / 72487		TRB
			Rockwell SQDD	42350 / 42584		TRB
Diferencial - pinhão (cabeza - cola) / Diferencial - piñón (cabeza / cola) / Differential - pinion head (rear)			Rockwell SQDD	72200 C / 72487		TRB
Diferencial - pinhão cola / Diferencial - piñón cola / Differential - pinion (rear)			Rockwell SQDD	497 / 493	81.93420.0195	TRB
Roda / Rueda / Wheel	•		Rockwell SQHD	580 / 572	39811405	TRB
		•	Rockwell SQHD	598 A / 592 A		TRB
	•		Rockwell SQDD	580 / 572	39811405	TRB
		•	Rockwell SQDD	598 A / 592 A		TRB

776

Eixo Traseiro / Eje Trasero / Rear Axle

Diferencial - (dir./esq.) / Diferencial - (der./izq.) / Differential (right / left)				32021 XF		TRB
Diferencial - pinhão cabeça / Diferencial - piñón cabeça / Differential - pinion head				9278 / 9220		TRB
Diferencial - pinhão cola / Diferencial - piñón cola / Differential - pinion (rear)				HM 813843 / HM 813810		TRB
Roda / Rueda / Wheel	•			580 / 572	39811405	TRB
		•		598 A / 592 A		TRB

Eixo Dianteiro / Eje Delantero / Front Axle

Roda / Rueda / Wheel	•			3782 / 3720	807949	TRB
		•		HM 212049 / HM 212011		TRB

861 K

Eixo Traseiro / Eje Trasero / Rear Axle

Diferencial - eixo de entrada / Diferencial - eje de entrada / Differential - input shaft			Tandem	JH 211749 / JH 211710	183844	TRB
Diferencial - eixo de saída / Diferencial - eje de salida / Differential - output shaft			Tandem	LM 104949 / LM 104910		TRB
Diferencial - interdiferencial / Diferencial - interdiferencial / Differential - interdifferential			Tandem	JLM 714149 / JLM 714110	183345	TRB
Diferencial - (dir./esq.) / Diferencial - (der./izq.) / Differential (right / left)			Tandem	47890 / 47820	181608 / 590762	TRB
Diferencial - pinhão (cabeza - cola) / Diferencial - piñón (cabeza / cola) / Differential - pinion head (rear)			Tandem	H 715343 / H 715311	500588901	TRB
Diferencial - pinhão cola / Diferencial - piñón cola / Differential - pinion (rear)			Tandem	65237 / 65500	32230	TRB
			Tandem	F 19034		CRBS

Direção / Dirección / Steering

Perno de direção / Perno de dirección / Pintle direction				T 182	DIHA 3123 A2A	TRBT
--	--	--	--	--------------	---------------	------

Eixo Traseiro / Eje Trasero / Rear Axle

Roda / Rueda / Wheel	•			580 / 572	39811405	TRB
		•	Spicer 550886	598 A / 592 A		TRB
		•		594 A / 592 A	183704	TRB

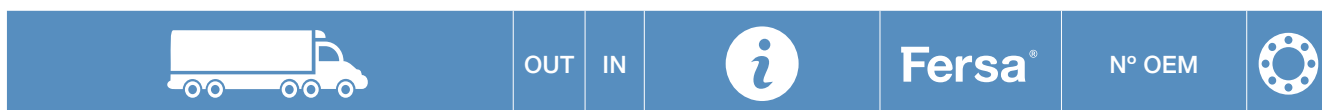

DINA

861 K

Eixo Dianteiro / Eje Delantero / Front Axle

Roda / Rueda / Wheel	•		FF-931 * FF-902. Serie 861K1	3782 / 3720	807949	TRB
		•	FF-931 * FF-902. Serie 861K1	HM 212047 / HM 212011	C4TA1215B	TRB
	•			3782 / 3720	807949	TRB
		•		HM 212049 / HM 212011		TRB

D9 160 * D12 160 Cab Over

Caixa de Mudanças / Caja de Cambios / Gearbox

			Fuller FS 5306 A No. Fuller 1313645 / 791943	25590 / 25522		TRB
			Fuller FS 5306 A No. Fuller 658981 / 660181	3782 / 3720	807949	TRB
			Fuller FS 5306 A No. Fuller 675250 / 742259	39590 / 39520	1240A / 2986843	TRB
			Fuller FS 5306 A No. Fuller 710787	31594 / 31520	9415226	TRB
			Fuller FS 5306 A No. Fuller 711123 / 5202047	45284 / 45220	2986840	TRB

Eixo Dianteiro / Eje Delantero / Front Axle

Roda / Rueda / Wheel	•			25877 / 25820		TRB
		•		JM 207049 / JM 207010		TRB

9400

Direção / Dirección / Steering

Perno de direção / Perno de dirección / Pintle direction				T 182	DIHA 3123 A2A	TRBT
Eixo Traseiro / Eje Trasero / Rear Axle						
Roda / Rueda / Wheel	•			580 / 572	39811405	TRB
		•	Spicer 550886	594 A / 592 A	183704	TRB

Eixo Dianteiro / Eje Delantero / Front Axle

Roda / Rueda / Wheel	•		FF-941, FF-943	3782 / 3720	807949	TRB
		•	FF-941, FF-942	HM 212047 / HM 212011	C4TA1215B	TRB

DCE 522570 * DCP 311970 * DCP 311 771 * DCP 351972

Eixo Traseiro / Eje Trasero / Rear Axle

Roda / Rueda / Wheel	•			580 / 572	39811405	TRB
		•		594 A / 592 A	183704	TRB

Eixo Dianteiro / Eje Delantero / Front Axle

Roda / Rueda / Wheel	•			3782 / 3720	807949	TRB
		•		HM 212049 / HM 212011		TRB



	OUT	IN		Fersa®	Nº OEM	
---	-----	----	---	---------------	--------	---

FAMSA

DC 10264 AUTOCAR

Eixo Traseiro / Eje Trasero / Rear Axle

Diferencial / Diferencial / Differential				47890 / 47820	590762	TRB
Diferencial - pinhão eixo (dianteiro) / Diferencial - piñón eje (delantero) / Differential - shaft pinion (front)				65237 / 65500	32230	TRB
				H 715334 / H 715311	500587901	TRB
Diferencial - pinhão eixo (traseiro) / Diferencial - piñón eje (traseiro) / Differential - shaft pinion rear				H 715345 / H 715311		TRBT
Roda / Rueda / Wheel	•			580 / 572	39811405	TRB
		•		681 A / 672		TRB

Direção / Dirección / Steering

Perno de direção / Perno de dirección / Pintle direction				T 163	DIHA 3123 B2A	TRB
--	--	--	--	--------------	---------------	-----

Eixo Dianteiro / Eje Delantero / Front Axle

Roda / Rueda / Wheel	•			3782 / 3720	807949	TRB
		•		HM 212044 / HM 212011		TRB

DC 9964 AUTOCAR

Eixo Traseiro / Eje Trasero / Rear Axle

Diferencial - flecha de entrada / Diferencial - flecha de entrada / Differential - input shaft			Rockwell SUDD	387 A / 382 A		TRB
Diferencial - flecha intermediária entrada (dir./esq.) / Diferencial - flecha intermedia - entrada (der./izq.) / Differential - intermediate input shaft (right/left)			Rockwell SUDD	HM 516449 / HM 516410		TRB
Diferencial - flecha transversal / Diferencial - flecha transversal / Differential - transversal shaft				641 / 632		TRB
Diferencial - (dir./esq.) / Diferencial - (der./izq.) / Differential (right/left)				65237 / 65500	32230	TRB
Diferencial - pinhão cabeça / Diferencial - piñón cabeza / Differential - pinion head				42381 / 42584	7451400	TRB
				H 715345 / H 715311		TRB
Diferencial - pinhão cola / Diferencial - piñón cola / Differential - pinion rear				HM 807046 / HM 807010		TRB
Diferencial - pinhão (dianteiro externo) / Diferencial - piñón delantero (externo) / Differential - pinion (outer front)			Rockwell SUDD	497 / 493	06.32499.0146	TRB
Diferencial - pinhão (dianteiro interno) / Diferencial - piñón delantero (interno) / Differential - pinion (inner front)			Rockwell SUDD	42381 / 42584		TRB
Diferencial - pinhão eixo (dianteiro) / Diferencial - piñón eje (delantero) / Differential - shaft pinion (front)				HM 807040 / HM 807010	451983	TRB
Diferencial - pinhão eixo (traseiro) / Diferencial - piñón eje (traseiro) / Differential - shaft pinion rear				H 715345 / H 715311		TRB
Roda / Rueda / Wheel	•			749 / 742		TRB
		•		760 / 752		TRB

Direção / Dirección / Steering

Perno de direção / Perno de dirección / Pintle direction				T 163	DIHA 3123 B2A	TRBT
--	--	--	--	--------------	---------------	------

Eixo Dianteiro / Eje Delantero / Front Axle

Roda / Rueda / Wheel	•			3982 / 3920	2TA/598313	TRB
		•		6461A / 6420		TRB

F 1314 * F 1317

Eixo Traseiro / Eje Trasero / Rear Axle

Diferencial (dir.) / Diferencial (der.) / Differential (right)			Eaton	497 / 493	06.32499.0146	TRB
--	--	--	-------	------------------	---------------	-----

	OUT	IN		Fersa®	N° OEM	
---	-----	----	---	---------------	--------	---

FAMSA

F 1314 * F 1317

Diferencial - (esq.) / Diferencial - (izq.) / Differential (left)			Eaton	56425 / 56650		TRB
Diferencial - pinhão cabeça / Diferencial - piñón cabeza / Differential - pinion head			Eaton	55200 C / 55437		TRB
Diferencial - pinhão eixo (traseiro) / Diferencial - piñón eje (traseiro) / Differential - shaft pinion rear			Eaton	72212 C / 72487		TRB

F 1521

Eixo Traseiro / Eje Trasero / Rear Axle

Diferencial (dir.) / Diferencial (der.) / Differential (right)			Eaton	497 / 493	06.32499.0146	TRB
Diferencial - (esq.) / Diferencial - (izq.) / Differential (left)			Eaton	56425 / 56650		TRB
Diferencial - pinhão cabeça / Diferencial - piñón cabeza / Differential - pinion head			Eaton	72200 C / 72487		TRB
Diferencial - pinhão cola / Diferencial - piñón cola / Differential - pinion rear			Eaton	55200 C / 55437		TRB

L1100 * L1200 * L1300 * L1400 * L1500 * L1600 * L2121

Eixo Traseiro / Eje Trasero / Rear Axle

Diferencial (dir.) / Diferencial (der.) / Differential (right)				497 / 493	06.32499.0146	TRB
Diferencial - pinhão cabeça / Diferencial - piñón cabeza / Differential - pinion head				72200 C / 72487		TRB
Diferencial - pinhão (cabeza - cola) / Diferencial - piñón (cabeza / cola) / Differential - pinion head rear				55200 C / 55437		TRB

Direção / Dirección / Steering

Perno de direção / Perno de dirección / Pintle direction				T 182	DIHA 3123 A2A	TRBT
--	--	--	--	-------	---------------	------

Eixo Dianteiro / Eje Delantero / Front Axle

Roda / Rueda / Wheel	•			3782 / 3720	807949	TRB
		•		HM 212047 / HM 212011	C4TA1215B	TRB

Eixo Traseiro / Eje Trasero / Rear Axle

Roda / Rueda / Wheel	•			39590 / 39520	1240A / 2986843	TRB
		•		47686 / 47620		TRB





FIAT

130 (76...)

Eixo Traseiro / Eje Trasero / Rear Axle

Diferencial - reduzida (dir./esq.) / Diferencial - reducción (der./izq.) / Differential - reduction (right/left)				HM 807046 / HM 807010		TRB
--	--	--	--	-----------------------	--	-----

Embreagem / Embrague / Clutch

Apoio / Apoyo / Support				6205 Z		BB
-------------------------	--	--	--	--------	--	----

Motor / Motor / Engine

Bomba injetora (dianteiro) / Bomba inyectora (delantero) / Injection pump (front)				6010		BB
---	--	--	--	------	--	----

Bomba injetora (traseiro) / Bomba inyectora (trasero) / Injection pump rear				6009		BB
---	--	--	--	------	--	----

130 OD (78...)

Eixo Traseiro / Eje Trasero / Rear Axle

Diferencial - lateral coroa / Diferencial - lateral corona / Differential - crown gear				31312 F	12080 / 1725200	TRB
--	--	--	--	---------	-----------------	-----

Diferencial - reduzida (dir./esq.) / Diferencial - reducción (der./izq.) / Differential - reduction (right/left)				HM 807046 / HM 807010		TRB
--	--	--	--	-----------------------	--	-----

Eixo Dianteiro / Eje Delantero / Front Axle

Roda / Rueda / Wheel	•			32308 F	2680/0610	TRB
		•		32312 F	2900 / 62320	TRB
			•	32311 F		TRB

Embreagem / Embrague / Clutch

Apoio / Apoyo / Support				6205 Z		BB
-------------------------	--	--	--	--------	--	----

Motor / Motor / Engine

Bomba injetora (dianteiro) / Bomba inyectora (delantero) / Injection pump (front)				6010	2/804250/0	BB
---	--	--	--	------	------------	----

Bomba injetora (traseiro) / Bomba inyectora (trasero) / Injection pump rear				6009		BB
---	--	--	--	------	--	----

Virabrequim - ponta / Cigüeñal - punta / Crankshaft spindle				6205 Z	2/804320/0	BB
---	--	--	--	--------	------------	----

Compressor de ar (traseiro) / Compresor de aire (trasero) / Air compressor rear				6011	96105 / 4478	BB
---	--	--	--	------	--------------	----

180 C * C3 * L * N * N3 (71...)

Caixa de Mudanças / Caja de Cambios / Gearbox

Eixo intermediário (dianteiro) / Eje intermedio (delantero) / Intermediate shaft (front)				6408		BB
--	--	--	--	------	--	----

Eixo primário - anterior (dianteiro) / Eje primario - anterior (delantero) / Primary shaft - previous (front)				6308		BB
---	--	--	--	------	--	----

Eixo secundário (interm.) / Eje secundario (interm.) / Secondary shaft (interm.)				6311		BB
--	--	--	--	------	--	----

Eixo secundário (traseiro) / Eje secundario (trasero) / Secondary shaft rear				6310		BB
--	--	--	--	------	--	----

Cardan / Cardan / Cardan

Suporte / Soporte / Support			180 L	6214		BB
-----------------------------	--	--	-------	------	--	----

Eixo Traseiro / Eje Trasero / Rear Axle

Diferencial - coroa lateral (dir./esq.) / Diferencial - corona lateral (der./izq.) / Differential - crown gear (right) / (left)				594 / 592 A		TRB
---	--	--	--	-------------	--	-----

Diferencial - (dianteiro / traseiro) / Diferencial (delantero / trasero) / Differential (front / rear)				31312 F	12080/17253	TRB
--	--	--	--	---------	-------------	-----

Diferencial - lateral coroa / Diferencial - lateral corona / Differential - crown gear				32213 F	2910 / 62247	TRB
--	--	--	--	---------	--------------	-----

Diferencial - lateral coroa (dir./esq.) / Diferencial - lateral corona (der./izq.) / Differential - crown gear (right/left)				594 / 592 A	1701/31022	TRB
---	--	--	--	-------------	------------	-----



OUT IN



Fersa®

N° OEM



FIAT

180 C * C3 * L * N * N3 (71...)

Eixo Traseiro / Eje Trasero / Rear Axle

Diferencial - pinhão (dianteiro / traseiro) / Diferencial - piñón (delantero / trasero) / Differential - pinion (front / rear)				31312 F		TRB
Diferencial - reduzida (dir.) / Diferencial - reducción (der.) / Differential - reduction (right)				32312 F		TRB
Roda / Rueda / Wheel				32312 F	2900/62320	TRB
	•			6408	2900 / 60165	BB

Eixo Dianteiro / Eje Delantero / Front Axle

Roda / Rueda / Wheel	•			32309 F	2900 / 62317	TRB
		•		32312 F	2900 / 62320	TRB

Embreagem / Embrague / Clutch

Apoio (dianteiro) / Apoyo (delantero) / Support (front)				6306 2RS		BB
Apoio (traseiro) / Apoyo (trasero) / Support rear				6209		BB

Motor / Motor / Engine

Bomba d'água (dianteiro) / Bomba de agua (delantero) / Water pump (front)				6304	2900 / 60114	BB
Bomba injetora (dianteiro) / Bomba inyectora (delantero) / Injection pump (front)				30204 F	9625/47015	TRB
Bomba injetora (traseiro) / Bomba inyectora (trasero) / Injection pump rear				30203 F	9625/47014	TRB
Virabrequim - ponta / Cigüeñal - punta / Crankshaft spindle				6306 2RS	1610 / 2300200	BB
Compressor de ar (dianteiro) / Compresor de aire (delantero) / Air compressor (front)				6207	9610 / 54467	BB
Compressor (traseiro) / Compresor (trasero) / Compressor rear				6011		BB
Dínamo (dianteiro) / Dinamo (delantero) / Dynamo (front)				6203 ZZ	9604 / 55099	BB
Dínamo (traseiro) / Dinamo (trasero) / Dynamo rear				6202 ZZ	9604 / 55102	BB
Polia tensora / Polea tensora / Tensioner pulley				6302	2900 / 60112	BB
Polia tensora - rodam. / Polea tensora - rodam. / Tensioner pulley - bearing				6302		BB

190 (77...)

Caixa de Mudanças / Caja de Cambios / Gearbox

Eixo intermed. - (auxiliar dianteiro) / Eje intermed. - auxiliar delantero / Auxiliar intermediate shaft (front)				NJ 307 FM		CRB
Eixo intermediário (traseiro) / Eje intermedio (trasero) / Intermediate shaft rear				NUP 308 FM		CRB
Eixo secundário (dianteiro) / Eje secundario (delantero) / Secondary shaft (front)				6017 NR		BB
Eixo secundário (interm.) / Eje secundario (interm.) / Secondary shaft (interm.)				6212 ZNR		BB

Eixo Traseiro / Eje Trasero / Rear Axle

Diferencial - coroa lateral (dir./esq.) / Diferencial - corona lateral (der./izq.) / Differential - crown gear (right) / (left)				30222 F		TRB
Diferencial - lateral coroa / Diferencial - lateral corona / Differential - crown gear				32213 F	2910/62247	TRB
Diferencial - pinhão (dianteiro) / Diferencial - piñón (delantero) / Differential - pinion (front)				32213 F		TRB
Diferencial - pinhão (traseiro) / Diferencial - piñón (trasero) / Differential - pinion rear				31314 F		TRB
Diferencial - reduzida esquerda / Diferencial - reducción izquierda / Differential - reduction (left)				32313 F	2910/62321	TRB

	OUT	IN		Fersa®	Nº OEM	
---	-----	----	---	---------------	--------	---

FIAT

190 (77...)

Eixo Traseiro / Eje Trasero / Rear Axle

Diferencial - reduzida (dir.) / Diferencial - reducción (der.) / Differential - reduction (right)				32315 F		TRB
Diferencial - reduzida (esq.) / Diferencial - reducción (izq.) / Differential - reduction (left)				32313 F		TRB
Roda / Rueda / Wheel	•			32219 F	2920/62253	TRB

Eixo Dianteiro / Eje Delantero / Front Axle

Roda / Rueda / Wheel	•			32309 F	2900/62317	TRB
		•		32312 F	2900/62320	TRB

Embreagem / Embrague / Clutch

Apoio / Apoyo / Support				6206 ZZ / C3		BB
Desengate / Desembrague / Clutch				6310 2RS		BB

Motor / Motor / Engine

Virabrequim - ponta / Cigüeñal - punta / Crankshaft spindle				6206 ZZ / C3	4690063	BB
Polia tensora - rolam. / Polea tensora - rodam. / Tensioner pulley - bearing				6304 2RS		BB

70 (77...) * 80

Cardan / Cardan / Cardan

Suporte / Soporte / Support				6214		BB
-----------------------------	--	--	--	-------------	--	----

Eixo Traseiro / Eje Trasero / Rear Axle

Diferencial - pinhão (dianteiro) / Diferencial - piñón (delantero) / Differential - pinion (front)			Albarus (M 70 HD)	HM 807040 / HM 807010		TRB
Diferencial - pinhão (traseiro) / Diferencial - piñón (trasero) / Differential - pinion rear				HM 807046 / HM 807010		TRB
			Albarus (M 70 HD)	HM 88542 / HM 88510		TRB
Roda / Rueda / Wheel		•		368 A / 362 A	502156	TRB
		•		3982 / 3920	502155	TRB

Eixo Dianteiro / Eje Delantero / Front Axle

Roda / Rueda / Wheel	•			30306 F	2680 / 00340	TRB
	•			32308 F	2680 / 0610	TRB
		•		32311 F	2680 / 0580	TRB
		•		30309 F	2680 / 0370	TRB

Embreagem / Embrague / Clutch

Apoio / Apoyo / Support				6205 Z		BB
-------------------------	--	--	--	---------------	--	----

Motor / Motor / Engine

Bomba injetora (traseiro) / Bomba inyectora (trasero) / Injection pump rear				30204 F	9625 / 47015	TRB
Virabrequim - ponta / Cigüeñal - punta / Crankshaft spindle				6205 Z	2/804320/0	BB

FNM 2000 * 2150

Eixo Dianteiro / Eje Delantero / Front Axle

Roda / Rueda / Wheel	•			32304 F	2900 / 623120	TRB
		•		30207 F	2900 / 62204	TRB

FNM 210 C * CM * LN (71...76)

Caixa de Mudanças / Caja de Cambios / Gearbox

Eixo primário - posterior (traseiro) / Eje primario - posterior (trasero) / Primary shaft (front / rear)				NUP 314 FMNR		CRB
--	--	--	--	---------------------	--	-----

	OUT	IN		Fersa®	N° OEM	
---	-----	----	---	---------------	--------	---

FIAT

FNM 210 C * CM * LN (71...76)

Caixa de Mudanças / Caja de Cambios / Gearbox

Eixo secundário (traseiro) / Eje secundario (trasero) / Secondary shaft rear				6314 NR / C3		BB
--	--	--	--	---------------------	--	----

Eixo Traseiro / Eje Trasero / Rear Axle

Diferencial - coroa lateral (dir./esq.) / Diferencial - corona lateral (der./izq.) / Differential - crown gear (right) / (left)				30222 F		TRB
Diferencial - lateral coroa / Diferencial - lateral corona / Differential - crown gear				31312 F	12080 / 1725200	TRB
Diferencial - pinhão (dianteiro) / Diferencial - piñón (delantero) / Differential - pinion (front)				32213 F		TRB
Diferencial - pinhão (traseiro) / Diferencial - piñón (trasero) / Differential - pinion rear				31314 F		TRB
Diferencial - reduzida esquerda / Diferencial - reducción izquierda / Differential - reduction (left)				32313 F	2910 / 62321	TRB
Diferencial - reduzida (dir.) / Diferencial - reducción (der.) / Differential - reduction (right)				32315 F		TRB
Diferencial - reduzida (esq.) / Diferencial - reducción (izq.) / Differential - reduction (left)				32313 F		TRB

Eixo Dianteiro / Eje Delantero / Front Axle

Roda / Rueda / Wheel	•			32308 F	2680 / 0610	TRB
		•		32311 F	2680 / 0580	TRB

Embreagem / Embrague / Clutch

Apoio (dianteiro) / Apoyo (delantero) / Support (front)				6306 2RS		BB
Apoio (traseiro) / Apoyo (trasero) / Support rear				6209		BB

Motor / Motor / Engine

Alternador (dianteiro) / Alternador (delantero) / Alternator (front)				6202 ZZ		BB
Alternador (traseiro) / Alternador (trasero) / Alternator rear				6201 ZZ		BB
Bomba d'água (dianteiro) / Bomba de agua (delantero) / Water pump (front)				6304	2900 / 60114	BB
Bomba injetora (dianteiro) / Bomba inyectora (delantero) / Injection pump (front)				30203 F	9625 / 47014	TRB
Bomba injetora (traseiro) / Bomba inyectora (trasero) / Injection pump rear				30204 F	9625 / 47015	TRB
Virabrequim - ponta / Cigüeñal - punta / Crankshaft spindle				6306 2RS	1610 / 2300200	BB
Polia tensora / Polea tensora / Tensioner pulley				6302	2900 / 60112	BB
Ventilador / Ventilador / Fan				6302		BB

FNM D-11000 (58...72)

Caixa de Mudanças / Caja de Cambios / Gearbox

Eixo intermediário (dianteiro) / Eje intermedio (delantero) / Intermediate shaft (front)				6408		BB
Eixo primário - anterior (dianteiro) / Eje primario - anterior (delantero) / Primary shaft - previous (front)				6308		BB
Eixo primário - anterior (traseiro) / Eje primario - anterior (trasero) / Primary shaft - previous rear			...68	6409		BB
Eixo secundário (interm.) / Eje secundario (interm.) / Secondary shaft (interm.)				6311		BB
Eixo secundário (traseiro) / Eje secundario (trasero) / Secondary shaft rear				6310		BB

Cardan / Cardan / Cardan

Suporte (dianteiro) / Soporte (delantero) / Support (front)				6212		BB
Suporte (traseiro) / Soporte (trasero) / Support rear				6310		BB

	OUT	IN		Fersa®	Nº OEM	
---	-----	----	---	---------------	--------	---

FIAT

FNM D-11000 (58...72)

Eixo Traseiro / Eje Trasero / Rear Axle

Diferencial - coroa lateral (dir./esq.) / Diferencial - corona lateral (der./izq.) / Differential - crown gear (right) / (left)				594 / 592 A		TRB
Diferencial - pinhão (dianteiro / traseiro) / Diferencial - piñón (delantero / trasero) / Differential - pinion (front / rear)			66...	31312 F		TRB
Diferencial - reduzida (esq.) / Diferencial - reducción (izq.) / Differential - reduction (left)				32312 F		TRB

Eixo Dianteiro / Eje Delantero / Front Axle

Roda / Rueda / Wheel		•		32312 F	2900 / 62320	TRB
----------------------	--	---	--	----------------	--------------	-----

Embreagem / Embrague / Clutch

Apoio (dianteiro) / Apoyo (delantero) / Support (front)				6306 2RS		BB
Apoio (traseiro) / Apoyo (trasero) / Support rear				6209		BB

Motor / Motor / Engine

Bomba d'água (dianteiro) / Bomba de agua (delantero) / Water pump (front)				6304	2900 / 60114	BB
Bomba d'água - rodam / Bomba de agua - rodam. / Water pump - bearing				6304		BB
Virabrequim - ponta / Cigüeñal - punta / Crankshaft spindle				6306 2RS	1610 / 2300200	BB
Comando distribuição - engren.interm. / Control de distribución - engranaje intermedio / Distribution control - intermediate gear			...68	6205		BB
Compressor de ar (dianteiro) / Compressor de aire (delantero) / Air compressor (front)			64...	6207	9610 / 54467	BB
Compressor de ar (traseiro) / Compressor de aire (trasero) / Air compressor rear			64...	6011	96105 / 4478	BB
Compressor (traseiro) / Compressor (trasero) / Compressor rear			...63	6205		BB
Dinamo (traseiro) / Dinamo (trasero) / Dynamo rear				6202 2ZR	9604 / 55102	BB
Dinamo (dianteiro) / Dinamo (delantero) / Dynamo (front)				6203 ZZ		BB
Dinamo (traseiro) / Dinamo (trasero) / Dynamo rear				6202 ZZ		BB
Ventilador / Ventilador / Fan				6304		BB

FNM D-9500 (50...57)

Caixa de Mudanças / Caja de Cambios / Gearbox

Eixo intermediário (dianteiro) / Eje intermedio (delantero) / Intermediate shaft (front)				6408		BB
Eixo primário / Eje primario / Primary shaft				6409		BB
Eixo secundário (traseiro) / Eje secundario (trasero) / Secondary shaft rear				6311		BB

Cardan / Cardan / Cardan

Suporte (dianteiro) / Soporte (delantero) / Support (front)				6212		BB
Suporte (traseiro) / Soporte (trasero) / Support rear				6310		BB

Direção / Dirección / Steering

Rosca sem fim (sup./ inf.) / Tornillo sin fin (sup./ inf.) / Worm gear (upper / lower)				30307 F		TRB
--	--	--	--	----------------	--	-----

Embreagem / Embrague / Clutch

Apoio / Apoyo / Support				6306 2RS		BB
-------------------------	--	--	--	-----------------	--	----

Motor / Motor / Engine

Bomba d'água (traseiro) / Bomba de agua (trasero) / Water pump rear				6205		BB
---	--	--	--	-------------	--	----

	OUT	IN		Fersa®	N° OEM	
---	-----	----	---	---------------	--------	---

FIAT

FNM D-9500 (50...57)

Bomba injetora - comando / Bomba inyectora - comando / Injection pump - command				6207 C3		BB
---	--	--	--	----------------	--	----

Motor / Motor / Engine

Comando distribuição - engren.interm. / Control de distribución - engranaje intermedio / Distribution control - intermediate gear				6205		BB
Compressor / Compresor / Compressor				6205		BB

FNM V-15 (69...74)

Caixa de Mudanças / Caja de Cambios / Gearbox

Eixo primário / Eje primario / Primary shaft				NUP 314 FMNR / C3		CRB
Eixo secundário (traseiro) / Eje secundario (trasero) / Secondary shaft rear				6314 NR / C3		BB

Eixo Traseiro / Eje Trasero / Rear Axle

Diferencial - coroa lateral (dir.) / Diferencial - corona lateral (der.) / Differential - crown gear (right)				32213 F		TRB
Diferencial - coroa lateral (esq.) / Diferencial - coroa lateral (izq.) / Differential - crown gear (left)				30213 F		TRB
Diferencial - eixo dupla ação direito / Diferencial - eje doble acción derecho / Differential - double action shaft (right)				32214 F	701109	TRB
Diferencial - lateral coroa (dir.) / Diferencial - lateral corona (der.) / Differential - crown gear (right)				32213 F		TRB
Diferencial - pinhão (dianteiro / traseiro) / Diferencial - piñón (delantero / trasero) / Differential - pinion (front / rear)				31313 F		TRB

Direção / Dirección / Steering

Braço secundário / Brazo secundario / Secondary arm				32206 F		TRB
---	--	--	--	----------------	--	-----

Embreagem / Embrague / Clutch

Apoio (dianteiro) / Apoyo (delantero) / Support (front)				6202 2RS		BB
Apoio (traseiro) / Apoyo (trasero) / Support rear				6209		BB

Motor / Motor / Engine

Bomba d'água (dianteiro) / Bomba de agua (delantero) / Water pump (front)				6304	2900 / 60114	BB
				30203 F	9625 / 47014	TRB
				30204 F	9625/47015	TRB
Bomba injetora (traseiro) / Bomba inyectora (trasero) / Injection pump rear				30204 F	9625 / 47015	TRB
				30203 F	9625/47014	TRB
Compressor de ar (dianteiro) / Compressor de aire (delantero) / Air compressor (front)				6207	9610 / 54467	BB
Compressor de ar (traseiro) / Compressor de aire (trasero) / Air compressor rear				6011	9610 / 54478	BB
Polia tensora / Polea tensora / Tensioner pulley				6302	2900 / 60112	BB
Ventilador / Ventilador / Fan				6302		BB





FORD (SA)

CARGO 1113 * 1114 * 1116 * 1117

Caixa de Mudanças / Caja de Cambios / Gearbox

Eixo intermediário (dianteiro) / Eje intermedio (delantero) / Intermediate shaft (front)			25877 / 25821	85HU7118A	TRB
Eixo intermediário (traseiro) / Eje intermedio (trasero) / Intermediate shaft rear		MWM * Ford 6,6/turbo * Cummins B 5.9 160 CIV-0 * Eaton - FS 4205	25877 / 25821		TRB
Eixo primário / Eje primario / Primary shaft		MWM * Cummins B 5.9 160 CIV-0 * Eaton - FS 4205	M 802048 / M 802011	85HU7025B	TRB

Eixo Traseiro / Eje Trasero / Rear Axle

Diferencial - coroa lateral (dir.) / Diferencial - corona lateral (der.) / Differential - crown gear (right)		Rockwell H-601	32015 XF		TRB
		1313 * 1314 * 1317	JM 716649 / JM 716610		TRB
Diferencial - coroa lateral (esq.) / Diferencial - corona lateral (izq.) / Differential - crown gear (left)			42381 / 42584	85HU4221A/1243A	TRB
		1313 * 1314 * 1317	JP 12049 / JP 12010		TRB
Diferencial - pinão (dianteiro) / Diferencial - piñón (delantero) / Differential - pinion (front)		Rockwell H-601	M 802048 / M 802011	87HU4621AA/4616	TRB
Roda / Rueda / Wheel	•		39590 / 39520	7EQH1238	TRB
		•	47686 / 47620	BD8T1243B	TRB

Eixo Dianteiro / Eje Delantero / Front Axle

Roda / Rueda / Wheel	•		3585 / 3525	8EB1216/81T1202	TRB
		•	39581 / 39520	8Q1200A	TRB

Motor / Motor / Engine

Alternador (dianteiro) / Alternador (delantero) / Alternator (front)		Bosch 75 A * Motor Ford 6,6 * 6,6 turbo * 6C/CT/CTA * Motor 8,3 L	6403 2RS / C3	BE5H10A303A	BB
Alternador (traseiro) / Alternador (trasero) / Alternator rear		Bosch 75 A * Motor Ford 6,6 * 6,6 turbo * 6C/CT/CTA * Motor 8,3 L	62201 2RS / C3	BE5H10A303B	BB
Bomba injetora (dianteiro) / Bomba inyectora (delantero) / Injection pump (front)		MWM D-229	6203		BB
		Ford 6,6/turbo * 6 CT/8,3 L	30203 F		TRB
Bomba injetora (traseiro) / Bomba inyectora (trasero) / Injection pump rear		Ford 6,6/turbo * 6 CT/8,3 L	30204 F		TRB

CARGO 1215

Caixa de Mudanças / Caja de Cambios / Gearbox

Eixo intermediário (traseiro) / Eje intermedio (trasero) / Intermediate shaft rear		MWM * Ford 6,6/turbo * Cummins B 5.9 160 CIV-0 * Eaton - FS 4205	25877 / 25821		TRB
Eixo primário / Eje primario / Primary shaft		MWM * Cummins B 5.9 160 CIV-0 * Eaton - FS 4205	M 802048 / M 802011		TRB

Eixo Traseiro / Eje Trasero / Rear Axle

Diferencial - coroa lateral (dir.) / Diferencial - corona lateral (der.) / Differential - crown gear (right)		Rockwell H-601	32015 XF		TRB
		1313/1314/1317	JM 716649 / JM 716610		TRB
Diferencial - coroa lateral (esq.) / Diferencial - corona lateral (izq.) / Differential - crown gear (left)		Rockwell H-601	42381 / 42584		TRB
		1313/1314/1317	JP 12049 / JP 12010		TRB
Diferencial - pinão (dianteiro) / Diferencial - piñón (delantero) / Differential - pinion (front)		Rockwell H-601	M 802048 / M 802011		TRB
Roda / Rueda / Wheel	•		580 / 572	TAJAA1240A	TRB
		•	594 A / 592 A	D7AH1244AA/ TUA1243A	TRB

Eixo Dianteiro / Eje Delantero / Front Axle

Roda / Rueda / Wheel	•		3585 / 3525	8EB1216/81T1202	TRB
		•	HM 212049 / HM 212011	D6HHS1240AA	TRB

	OUT	IN		Fersa®	N° OEM	
---	-----	----	---	---------------	--------	---

FORD (SA)

CARGO 1215

Motor / Motor / Engine

Alternador (dianteiro) / Alternador (delantero) / Alternator (front)				6203 2RS / C3	7RA10094A	BB
			Bosch 75 A * Motor Ford 6,6 * 6,6 turbo * 6C/CT/CTA * Motor 8,3 L	6403 2RS / C3		BB
Alternador (traseiro) / Alternador (trasero) / Alternator rear				6201 2RS / C3	BDOT7580A	BB
			Bosch 75 A * Motor Ford 6,6 * 6,6 turbo * 6C/CT/CTA * Motor 8,3 L	62201 2RS / C3		BB
Bomba injetora (dianteiro) / Bomba inyectora (delantero) / Injection pump (front)			MWM D-229	6203		BB
			Ford 6,6/turbo * 6 CT/8,3 L	30203 F		TRB
Bomba injetora (traseiro) / Bomba inyectora (trasero) / Injection pump rear			Ford 6,6/turbo * 6 CT/8,3 L	30204 F		TRB

CARGO 1313 * 1314 * 1317 * 1317E

Caixa de Mudanças / Caja de Cambios / Gearbox

Eixo intermediário (dianteiro) / Eje intermedio (delantero) / Intermediate shaft (front)				25877 / 25821	85HU7118A	TRB
Eixo intermediário (traseiro) / Eje intermedio (trasero) / Intermediate shaft rear			MWM * Ford 6,6/turbo * Cummins B 5.9 160 CIV-0 * Eaton - FS 4205	25877 / 25821		TRB
Eixo primário / Eje primario / Primary shaft			MWM * Cummins B 5.9 160 CIV-0 * Eaton - FS 4205	M 802048 / M 802011	85HU7025B	TRB

Eixo Traseiro / Eje Trasero / Rear Axle

Diferencial - coroa lateral (dir.) / Diferencial - corona lateral (der.) / Differential - crown gear (right)			Rockwell H-601	32015 XF		TRB
			1313 * 1314 * 1317	JM 716649 / JM 716610		TRB
Diferencial - coroa lateral (esq.) / Diferencial - coroa lateral (izq.) / Differential - crown gear (left)			Rockwell H-601	42381 / 42584		TRB
			1313 * 1314 * 1317	JP 12049 / JP 12010		TRB
Diferencial - pinão (dianteiro) / Diferencial - piñón (delantero) / Differential - pinion (front)				HM 804846 / HM 804810		TRB
			Rockwell H-601	M 802048 / M 802011		TRB
Roda / Rueda / Wheel	•			580 / 572	SKTAJAA1238A	TRB
		•		594 / 592 A	D7AH1244AA/ TUAA1243A	TRB

Eixo Dianteiro / Eje Delantero / Front Axle

Roda / Rueda / Wheel	•			3782 / 3720	NCB44134A	TRB
		•		HM 212047 / HM 212011	C4TA1215B	TRB

Motor / Motor / Engine

Alternador (dianteiro) / Alternador (delantero) / Alternator (front)			Bosch 75 A * Motor Ford 6,6 * 6,6 turbo * 6C/CT/CTA * Motor 8,3 L	6403 2RS / C3	BE5H10A303A	BB
Alternador (traseiro) / Alternador (trasero) / Alternator rear			Bosch 75 A * Motor Ford 6,6 * 6,6 turbo * 6C/CT/CTA * Motor 8,3 L	62201 2RS / C3	BE5H10A303B	BB
Bomba injetora (dianteiro) / Bomba inyectora (delantero) / Injection pump (front)			MWM D-229	6203		BB
			Ford 6,6/turbo * 6 CT/8,3 L	30203 F		TRB
Bomba injetora (traseiro) / Bomba inyectora (trasero) / Injection pump rear			Ford 6,6/turbo * 6 CT/8,3 L	30204 F		TRB

	OUT	IN		Fersa®	Nº OEM	
---	-----	----	---	---------------	--------	---

FORD (SA)

CARGO 1415 * 1416

Caixa de Mudanças / Caja de Cambios / Gearbox

Eixo intermediário (dianteiro) / Eje intermedio (delantero) / Intermediate shaft (front)		FS-6	25590 / 25522		TRB
		MWM * Ford 6,6	25877 / 25821		TRB
Eixo intermediário (traseiro) / Eje intermedio (traseiro) / Intermediate shaft rear		Cargo 1422 (Cummins 6 BT AA-160/ 6 CT AA-215 * Eaton - FS 6306 A)	25590 / 25522		TRB
		Cummins 6 BT AA-160/ 6 CT AA-215 * Eaton-FS 4205 * 1617 * 1621 (1997- Cummins B 5.9 160 / 5.9 205 * Eaton-FS 5205 A)	25877 / 25821		TRB
Eixo primário / Eje primario / Primary shaft		Cummins 6 BT AA-160/ 6 CT AA-215 * Eaton - FS 6306 A	39590 / 39520		TRB
		MWM * Cummins 6 BT AA-160/ 6 CT AA-215 * Eaton - FS 4205	M 802048 / M 802011		TRB
Eixo secundário (dianteiro) / Eje secundario (delantero) / Secondary shaft (front)			31594 / 31520		TRB

Eixo Traseiro / Eje Trasero / Rear Axle

Diferencial - coroa lateral (dir./esq.) / Diferencial - corona lateral (der./izq.) / Differential - crown gear (right) / (left)		4030 (Cummins 6 CTA-291 * Meritor RS 23-160)	594 A / 592 A		TRB
		1422 Cummins 6BTAA-160/ 6CTAA-215 * Rockwell 23-145 STD/23-230 OPC	JM 716649 / JM 716610		TRB
Diferencial - coroa lateral (dir.) / Diferencial - corona lateral (der.) / Differential - crown gear (right)		Rockwell H-601	32015 XF		TRB
		Rockwell 220	42381 / 42584		TRB
			JM 716649 / JM 716610		TRB
Diferencial - coroa lateral (esq.) / Diferencial - corona lateral (izq.) / Differential - crown gear (left)		Rockwell 220	32015 XF		TRB
		Rockwell H-601	42381 / 42584		TRB
		1617 * 1621 Cummins B5.9 160/5.9 205 * Meritor RS23-40 * 1622 Cummins 6CTAA-215 Meritor RS 23-240	JP 12049 / JP 12010		TRB
Diferencial - pinão (dianteiro) / Diferencial - piñón (delantero) / Differential - pinion (front)		Rockwell H-601	M 802048 / M 802011		TRB
Roda / Rueda / Wheel	•		580 / 572	TAJAA1240A	TRB
	•		594 A / 592 A	D7AH1244AA/ TUAA1243A	TRB

Eixo Dianteiro / Eje Delantero / Front Axle

Roda / Rueda / Wheel	•		3585 / 3525	8EB1216/81T1202	TRB
	•		HM 212049 / HM 212011	D6HHS1240AA	TRB

Motor / Motor / Engine

Alternador (dianteiro) / Alternador (delantero) / Alternator (front)		Bosch 75A * Motor Ford 6,6 * 6,6 turbo * 6C/CT/CTA * Motor 8,3 L	6203 2RS / C3	7RA10094A	BB
			6403 2RS / C3		BB
Alternador (traseiro) / Alternador (traseiro) / Alternator rear			6201 2RS / C3	BDOT7580A	BB
		Bosch 75A * Motor Ford 6,6 * 6,6 turbo * 6C/CT/CTA * Motor 8,3 L	62201 2RS / C3		BB

	OUT	IN		Fersa®	Nº OEM	
---	-----	----	---	---------------	--------	---

FORD (SA)

CARGO 1415 * 1416

Bomba injetora (dianteiro) / Bomba inyectora (delantero) / Injection pump (front)			MWM D-229	6203		BB
			Ford 6,6/turbo * 6 CT/8,3 L	30203 F		TRB
Bomba injetora (traseiro) / Bomba inyectora (traseiro) / Injection pump rear			Ford 6,6/turbo * 6 CT/8,3 L	30204 F		TRB

Cargo 1422 * 1514 * 1517 * 1517E * 1615 * 1615T * 1617 * 1618 * 1618T * 1619 * 1621 * 1622 * 1717E * 1722 * 1722E * 2216 * 2217 * 2218 * 2218T * 2319 * 2322 * 2324 * 2422 * 2422E * 2425 * 2428E * 2630 * 3224 * 3530 * 4030

Caixa de Mudanças / Caja de Cambios / Gearbox

Eixo intermediário (dianteiro) / Eje intermedio (delantero) / Intermediate shaft (front)			FS-6	25590 / 25522	B7T1201A/ E7HZ7K228A	TRB
			MWM * Ford 6,6	25877 / 25821	85HU7118A	TRB
Eixo intermediário (traseiro) / Eje intermedio (traseiro) / Intermediate shaft rear			Cargo 1422 (Cummins 6 BT AA-160/ 6 CT AA-215 * Eaton - FS 6306 A)	25590 / 25522		TRB
			Cummins 6 BT AA-160/ 6 CT AA-215 * Eaton-FS 4205 * 1617 * 1621 (1997- Cummins B 5.9 160 / 5.9 205 * Eaton-FS 5205 A)	25877 / 25821		TRB
				3782 / 3720	B5QM1216A/9N4222	TRB
Eixo primário / Eje primario / Primary shaft			Cummins 6 BT AA-160/ 6 CT AA-215 * Eaton - FS 6306 A	39590 / 39520		TRB
			MWM * Cummins 6 BT AA-160/ 6 CT AA-215 * Eaton - FS 4205	M 802048 / M 802011	85HU7025B	TRB
Eixo secundário (dianteiro) / Eje secundario (delantero) / Secondary shaft (front)				31594 / 31520	8M4630	TRB
Eixo secundário (traseiro) / Eje secundario (traseiro) / Secondary shaft rear				45284 / 45220	TGAA1201A/1202A	TRB

Eixo Traseiro / Eje Trasero / Rear Axle

Diferencial - coroa lateral (dir./esq.) / Diferencial - corona lateral (der./izq.) / Differential - crown gear (right) / (left)			4030 (Cummins 6 CTAA-291 * Meritor RS 23-160	594 A / 592 A		TRB
			1422 Cummins 6BTAA- 160/ 6CTAA-215 * Rockwell 23-145 STD/23-230 OPC	JM 716649 / JM 716610		TRB
Diferencial - coroa lateral (dir.) / Diferencial - corona lateral (der.) / Differential - crown gear (right)			Rockwell H-601	32015 XF		TRB
			Rockwell 220	42381 / 42584		TRB
				JM 716649 / JM 716610		TRB
				JM 716649 / JM 716610		TRB
Diferencial - coroa lateral (esq.) / Diferencial - corona lateral (izq.) / Differential - crown gear (left)			Rockwell 220	32015 XF		TRB
			Rockwell H-601	42381 / 42584		TRB
			1617 * 1621 Cummins B5.9 160/5.9 205 * Meritor RS23-40 * 1622 Cummins 6CTAA- 215 Meritor RS 23-240	JP 12049 / JP 12010		TRB
				42381 / 42584	85HU4221A/1243A	TRB
				52400 / 52618		TRB
Diferencial - pinhão (dianteiro) / Diferencial - piñón (delantero) / Differential - pinion (front)			Rockwell H-601	M 802048 / M 802011		TRB



FORD (SA)

Cargo 1422 * 1514 * 1517 * 1517E * 1615 * 1615T * 1617 * 1618 * 1618T * 1619 * 1621 * 1622 * 1717E * 1722 * 1722E * 2216 * 2217 * 2218 * 2218T * 2319 * 2322 * 2324 * 2422 * 2422E * 2425 * 2428E * 2630 * 3224 * 3530 * 4030

Eixo Traseiro / Eje Trasero / Rear Axle

Roda / Rueda / Wheel				55200 C / 55437		TRB
	•			580 / 572	SKTAJAA1238A	TRB
		•		594 / 592 A	D7AH1244AA/ TUAA1243A	TRB
				68462 / 68712		TRB
				78225 C / 78551		TRB
				HM 804846 / HM 804810		TRB
				M 802048 / M 802011	87HU4621AA/4616	TRB

Eixo Dianteiro / Eje Delantero / Front Axle

Roda / Rueda / Wheel	•			3782 / 3720	NCB44134A	TRB
		•		HM 212047 / HM 212011	C4TA1215B / D6HS1240AA	TRB

Motor / Motor / Engine

Alternador (dianteiro) / Alternador (delantero) / Alternator (front)			Bosch 75A * Motor Ford 6,6 * 6,6 turbo * 6C/CT/CTA * Motor 8,3 L	6403 2RS / C3	BE5H10A303A	BB
Alternador (traseiro) / Alternador (trasero) / Alternator rear			Bosch 75A * Motor Ford 6,6 * 6,6 turbo * 6C/CT/CTA * Motor 8,3 L	62201 2RS / C3	BE5H10A303B	BB
Bomba injetora (dianteiro) / Bomba inyectora (delantero) / Injection pump (front)			MWM D-229	6203		BB
			Ford 6,6/turbo * 6 CT/8,3 L	30203 F		TRB
Bomba injetora (traseiro) / Bomba inyectora (trasero) / Injection pump rear			Ford 6,6/turbo * 6 CT/8,3 L	30204 F		TRB

CARGO 814

Caixa de Mudanças / Caja de Cambios / Gearbox

Eixo Intermediário (dianteiro / traseiro) / Eje Intermedio (delantero / trasero) / Intermediate shaft (front / rear)			Cummins 4 BT AA * Eaton - FSO 4305 A	25877 / 25821		TRB
Eixo primário / Eje primario / Primary shaft				6211 ZNR	BC5T7025A	BB
			Cummins 4 BT AA * Eaton - FSO 4305 A	M 802048 / M 802011		TRB
Eixo secundário / Eje secundario / Secondary shaft			Cummins 4 BT AA * Eaton - FSO 4305 A	25581 / 25520		TRB
Eixo secundário (dianteiro) / Eje secundario (delantero) / Secondary shaft (front)				6211 ZNR	BC5T7025A	BB
Eixo secundário (traseiro) / Eje secundario (trasero) / Secondary shaft rear				6308 N	7EQ7065	BB
				6308 NR	BC5T765A	BB
				6309 NR	BDO7065	BB

Eixo Traseiro / Eje Trasero / Rear Axle

Diferencial - pinão (dianteiro) / Diferencial - piñón (delantero) / Differential - pinion (front)			Cummins 4 BT AA * Dana 80	HM 807046 / HM 807010		TRB
---	--	--	------------------------------	----------------------------------	--	-----

Eixo Traseiro / Eje Trasero / Rear Axle

Diferencial - pinão (traseiro) / Diferencial - piñón (trasero) / Differential - pinion rear			Cummins 4 BT AA * Dana 80	M 802048 / M 802011		TRB
Roda / Rueda / Wheel		•		3982 / 3920	B6T1243A/1244A	TRB

Eixo Dianteiro / Eje Delantero / Front Axle

Roda / Rueda / Wheel	•			15106 / 15250 X	91T1216A	TRB
		•		25590 / 25522	B7T1201A	TRB

	OUT	IN		Fersa®	N° OEM	
---	-----	----	---	---------------	--------	---

FORD (SA)

CARGO 814

Embreagem / Embrague / Clutch

Apoio / Apoyo / Support				6203 2RS	707600 B	BB
-------------------------	--	--	--	-----------------	----------	----

CARGO 815 * 815 E

Caixa de Mudanças / Caja de Cambios / Gearbox

Eixo primário / Eje primario / Primary shaft				6211 ZNR	BC5T7025A	BB
Eixo secundário (dianteiro) / Eje secundario (delantero) / Secondary shaft (front)				6211 ZNR	BC5T7025A	BB
Eixo secundário (traseiro) / Eje secundario (trasero) / Secondary shaft rear				6308 N	7EQ7065	BB
				6308 NR	BC5T765A	BB
				6309 NR	BDO7065	BB

Eixo Traseiro / Eje Trasero / Rear Axle

Diferencial - pinão (traseiro) / Diferencial - piñón (trasero) / Differential - pinion rear				M 802048 / M 802011		TRB
Roda / Rueda / Wheel		•		3982 / 3920	B6T1243A/1244A	TRB

Eixo Dianteiro / Eje Delantero / Front Axle

Roda / Rueda / Wheel	•			15106 / 15250 X	91T1216A	TRB
		•		25590 / 25522	B7T1201A	TRB

Embreagem / Embrague / Clutch

Apoio / Apoyo / Support				6203 2RS	707600 B	BB
-------------------------	--	--	--	-----------------	----------	----



F 100 (61...80 Diesel) * F 600 (56...77 Gas.) * F 700 (77...80) * F 750 (72...77) * 750 * 2000 * 4000

Caixa de Mudanças / Caja de Cambios / Gearbox

Eixo intermediário (traseiro) / Eje intermedio (trasero) / Intermediate shaft rear			Fuller seco * F 600 (65...71)	6307 ZNR		BB
Eixo primário / Eje primario / Primary shaft			Fuller seco * F 600 (65...71)	6211 ZNR	BC5T7025A	BB
Eixo secundário (dianteiro) / Eje secundario (delantero) / Secondary shaft (front)			Fuller seco * F 600 (65...71)	6211 ZNR	BC5T7025A	BB
Eixo secundário (traseiro) / Eje secundario (trasero) / Secondary shaft rear			F 600 (56...77)	6308 N	7EQ7065	BB
			Fuller seco * F 600 (65...71)	6308 NR	BC5T765A	BB
				6309 NR	BDO7065	BB

Eixo Traseiro / Eje Trasero / Rear Axle

Diferencial - coroa lateral (dir.) / Diferencial - corona lateral (der.) / Differential - crown gear (right)				59175 / 59412	BC8T4A000H	TRB
			F 700, 750 * 72...80	HM 807046 / HM 807010		TRB
Diferencial - coroa lateral (esq.) / Diferencial - coroa lateral (izq.) / Differential - crown gear (left)				HM 807040 / HM 807010	BC8T4A000C	TRB
Diferencial - pinão (dianteiro) / Diferencial - piñón (delantero) / Differential - pinion (front)			F 700, 750 * 72...80	387 / 382 A		TRB
				387 / 382 A		TRB
				HM 803145 / HM 803110	B28T4A000G	TRB
Diferencial - pinão (traseiro) / Diferencial - piñón (trasero) / Differential - pinion rear			F 600 * 60...80	HM 807046 / HM 807010		TRB
				HM 813842 / HM 813810	BD2T4625A	TRB

	OUT	IN		Fersa®	Nº OEM	
---	-----	----	---	---------------	--------	---

FORD (SA)

F 100 (61...80 Diesel) * F 600 (56...77 Gas.) * F 700 (77...80) * F 750 (72...77) * 750 * 2000 * 4000

Roda / Rueda / Wheel		•		33287 / 33462	BC8T4A000K	TRB
	•			39590 / 39520	BDOT1239A/1240A	TRB
	•			3982 / 3920	B6T1243A/1244A	TRB
		•		JM 714249 / JM 714210	BDOT12438	TRB

Eixo Dianteiro / Eje Delantero / Front Axle

Roda / Rueda / Wheel	•			15106 / 15250 X	91T1216A	TRB
				25590 / 25522	B7T1201A	TRB
	•			2780 / 2720	BD2T1216A/1217A	TRB
		•		45284 / 45220	TGAA1201A/1202A	TRB
				LM 501349 / LM 501310		TRB

Embreagem / Embrague / Clutch

Apoio / Apoyo / Support			F 600/700/750	6203 ZZ	707600 B	BB
-------------------------	--	--	---------------	----------------	----------	----

Motor / Motor / Engine

Alternador (dianteiro) / Alternador (delantero) / Alternator (front)				6204 2RS		BB
				6204 2RS / C3		BB
			Diesel (74...77)	6206 2RS / C3		BB
Alternador (traseiro) / Alternador (trasero) / Alternator rear			...73	6200 2RS		BB
				6203 2RS / C3	7RA10094A	BB
			F 600 diesel	6205 2RS / C3		BB
Bomba d'água - rolam / Bomba de agua - rodam. / Water pump - bearing			68...	6305 2RS		BB
Dinamo (dianteiro) / Dinamo (delantero) / Dynamo (front)				6203 2RS / C3	7RA10094A	BB
				6206 2RS / C3		BB
				6200 2RS	80235	BB

F 11000 * F 12000

Eixo Traseiro / Eje Trasero / Rear Axle

Diferencial - caixa satélite (dir./esq.) / Diferencial - caja satélite (der./izq.) / Differential - satellit box (right/left)			F 13000 * 14000 (81...86) * 21000	HM 807040 / HM 807010		TRB
Diferencial - coroa lateral (dir./esq.) / Diferencial - corona lateral (der./izq.) / Differential - crown gear (right) / (left)			F-12000 F-14000	JM 716649 / JM 716610		TRB
Diferencial - coroa lateral (dir.) / Diferencial - corona lateral (der.) / Differential - crown gear (right)				59175 / 59412	BC8T4A000H	TRB
Diferencial - coroa lateral (esq.) / Diferencial - corona lateral (izq.) / Differential - crown gear (left)				42688 / 42620	BD2T4561A	TRB
			Cummins B5.9 205 CIV-0 * Meritor RS 23-240	JP 12049 / JP 12010		TRB
Diferencial - pinão (dianteiro) / Diferencial - piñón (delantero) / Differential - pinion (front)				HM 803145 / HM 803110	B28T4A000G	TRB
Diferencial - pinão (traseiro) / Diferencial - piñón (trasero) / Differential - pinion rear			F 11000 (81...86) * 12000 * 13000 * 14000 (81...86) * 190 (77...)00 * 21000	HM 807046 / HM 807010	BC8T4A000C	TRB
Roda / Rueda / Wheel	•			39590 / 39520	BDOT1239A/1240A	TRB
		•		47686 / 47620	7EQH1238	TRB

Eixo Dianteiro / Eje Delantero / Front Axle

Roda / Rueda / Wheel	•			2780 / 2720	BD2T1216A/1217A	TRB
		•		45284 / 45220	TGAA1201A/1202A	TRB

Motor / Motor / Engine

Alternador (dianteiro) / Alternador (delantero) / Alternator (front)				6203 2RS / C3	7RA10094A	BB
			MWM	6206 2RS / C3		BB

	OUT	IN		Fersa®	N° OEM	
---	-----	----	---	---------------	--------	---

FORD (SA)

F 11000 * F 12000

Alternador (traseiro) / Alternador (trasero) /
Alternator rear

MWM

6201 2RS / C3

BB

F 13000 * F 14000 * F 16000

Eixo Traseiro / Eje Trasero / Rear Axle

Diferencial - caixa satélite (dir./esq.) / Diferencial - caja satélite (der./izq.) / Differential - satellit box (right/left)			F 13000 * 14000 (81...86) * 21000	HM 807040 / HM 807010		TRB
Diferencial - coroa lateral (dir./esq.) / Diferencial - corona lateral (der./izq.) / Differential - crown gear (right) / (left)			F-12000 F-14000	JM 716649 / JM 716610		TRB
Diferencial - coroa lateral (esq.) / Diferencial - coroa lateral (izq.) / Differential - crown gear (left)			Cummins B5.9 205 CIV-0 * Meritor RS 23-240	JP 12049 / JP 12010		TRB
Diferencial - pinão (dianteiro) / Diferencial - piñón (delantero) / Differential - pinion (front)				HM 804843 / HM 804810	BD2T4615A	TRB
Diferencial - pinão (traseiro) / Diferencial - piñón (trasero) / Differential - pinion rear			F 11000 (81...86) * 12000 * 13000 * 14000 (81...86) * 190 (77...00) * 21000	HM 807046 / HM 807010	BC8T4A00OC	TRB
				HM 813842 / HM 813810	BD2T4625A	TRB
Roda / Rueda / Wheel		•		47686 / 47620	7EQH1238	TRB
		•		594 / 592 A	D7AH1244AA/ TUAA1243A	TRB

Eixo Dianteiro / Eje Delantero / Front Axle

Roda / Rueda / Wheel	•			3585 / 3525	8EB1216/81T1202	TRB
		•		39581 / 45220	8Q1201A/ TGAA1202A	TRB
		•		45284 / 45220	TGAA1201A/1202A	TRB

Motor / Motor / Engine

Alternador (dianteiro) / Alternador (delantero) / Alternator (front)				6203 2RS / C3	7RA10094A	BB
			MWM	6206 2RS / C3		BB
Alternador (traseiro) / Alternador (trasero) / Alternator rear			MWM	6201 2RS / C3		BB

F 19000 (77...) * F 21000 * F 22000

Eixo Traseiro / Eje Trasero / Rear Axle

Diferencial - caixa satélite (dir./esq.) / Diferencial - caja satélite (der./izq.) / Differential - satellit box (right/left)			F 13000 * 14000 (81...86) * 21000	HM 807040 / HM 807010		TRB
Diferencial - coroa lateral (dir./esq.) / Diferencial - corona lateral (der./izq.) / Differential - crown gear (right) / (left)			F-12000 F-14000	JM 716649 / JM 716610		TRB
Diferencial - coroa lateral (esq.) / Diferencial - coroa lateral (izq.) / Differential - crown gear (left)			Cummins B5.9 205 CIV-0 * Meritor RS 23-240	JP 12049 / JP 12010		TRB
Diferencial - pinão (dianteiro) / Diferencial - piñón (delantero) / Differential - pinion (front)				HM 804843 / HM 804810	BD2T4615A	TRB
Diferencial - pinão (traseiro) / Diferencial - piñón (trasero) / Differential - pinion rear			F 11000 (81...86) * 12000 * 13000 * 14000 (81...86) * 190 (77...00) * 21000	HM 807046 / HM 807010	BC8T4A00OC	TRB
Roda / Rueda / Wheel	•			39590 / 39520	BDOT1239A/1240A	TRB
		•		47686 / 47620	7EQH1238	TRB

Eixo Dianteiro / Eje Delantero / Front Axle

Roda / Rueda / Wheel	•			2780 / 2720	BD2T1216A/1217A	TRB
		•		45284 / 45220	TGAA1201A/1202A	TRB

Motor / Motor / Engine

Alternador (dianteiro) / Alternador (delantero) / Alternator (front)				6203 2RS / C3	7RA10094A	BB
			MWM	6206 2RS / C3		BB
				6403 2RS / C3	BE5H10A303A	BB

	OUT	IN		Fersa®	N° OEM	
---	-----	----	---	---------------	--------	---

FORD (NA & CA)

F-350 * P-350

Eixo Traseiro / Eje Trasero / Rear Axle

Diferencial - (dir.) e (esq.) (eixo traseiro) / Diferencial - derecho e (izq.) / Differential - rear axle (right/left)				387 A / 382 S	91007313	TRB
Diferencial - pinhão cabeça (eixo traseiro) / Diferencial - piñón cabeça (eje trasero) / Differential - pinion head (rear shaft)				HM 88542 / HM 88510	11440284	TRB
Diferencial - pinhão cola / Diferencial - piñón cola / Differential - pinion rear				HM 803149 / HM 803110		TRB
				HM 807040 / HM 807010	71LB4625A1A	TRB
Roda / Rueda / Wheel	•		76...00	LM 104949 / LM 104911		TRB
		•	76...00	387 AS / 382 A		TRB

Eixo Dianteiro / Eje Delantero / Front Axle

Roda / Rueda / Wheel	•		76...90	15101 / 15245		TRB
		•	76...90	LM 102949 / LM 102910		TRB
	•		...00	15101 / 15245		TRB
		•	...00	LM 501349 / LM 501310	291407625A	TRB

F-350 Super Duty

Eixo Traseiro / Eje Trasero / Rear Axle

Diferencial (dir.) / Diferencial (der.) / Differential (right)				JLM 104946 / JLM 104911 A		TRB
Diferencial - (esq.) / Diferencial - (izq.) / Differential (left)				469 / 453		TRB
Diferencial - pinhão cola / Diferencial - piñón cola / Differential - pinion rear				HM 89443 / HM 89411		TRB
Roda / Rueda / Wheel	•			39250 / 39412		TRB
		•		33281 / 33462		TRB

Eixo Dianteiro / Eje Delantero / Front Axle

Roda / Rueda / Wheel	•			15101 / 15245		TRB
		•		LM 501349 / LM 501310	291407625A	TRB

F-450 * F-450 Super Duty

Eixo Traseiro / Eje Trasero / Rear Axle

Diferencial - eixo (traseiro) / Diferencial - eje (trasero) / Differential - rear shaft				387 A / 382 S	91007313	TRB
Diferencial - (dir./esq.) / Diferencial - (der./izq.) / Differential (right/left)				469 / 453 X		TRB
Diferencial - pinhão cabeça / Diferencial - piñón cabeça / Differential - pinion head				HM 807046 / HM 807011		TRB
Diferencial - pinhão cola / Diferencial - piñón cola / Differential - pinion rear				M 802048 / M 802011		TRB
Roda / Rueda / Wheel	•			39250 / 39412		TRB
		•		33281 / 33462		TRB

Eixo Dianteiro / Eje Delantero / Front Axle

Roda / Rueda / Wheel	•			15101 / 15245		TRB
		•		LM 501349 / LM 501310	291407625A	TRB

F-550 Super Duty

Eixo Traseiro / Eje Trasero / Rear Axle

Diferencial - (dir./esq.) / Diferencial - (der./izq.) / Differential (right/left)				469 / 453		TRB
Roda / Rueda / Wheel	•			39250 / 39412		TRB
		•		33281 / 33462		TRB



FORD (NA & CA)

F-550 Super Duty

Eixo Dianteiro / Eje Delantero / Front Axle

Roda / Rueda / Wheel	•			15101 / 15245		TRB
		•		LM 501349 / LM 501310	291407625A	TRB

F-600 * B-600

Caixa de Mudanças / Caja de Cambios / Gearbox

			Tremec CL559 No. Fuller 235417 / 235418	M 804049 / M 804010		TRB
			Tremec CL559 No. Fuller 654166 / 791943	25590 / 25520		TRB
			Tremec FS 5005 No. Fuller 235417 / 235418	M 804049 / M 804010		TRB
			Tremec FS 5005 No. Fuller 654166 / 791943	25590 / 25520		TRB
			Tremec FSM 5005 No. Fuller 235417 / 235418	M 804049 / M 804010		TRB
			Tremec FSM 5005 No. Fuller 654166 / 791943	25590 / 25520		TRB

Eixo Traseiro / Eje Trasero / Rear Axle

Diferencial - eixo (traseiro) / Diferencial - eje (trasero) / Differential - rear shaft				HM 807040 / HM 807010	71LB4625A1A	TRB
Diferencial (dir.) / Diferencial (der.) / Differential (right)			15,000 lb.	33275 / 33472		TRB
			17,000 lb.	497 / 493	7451380	TRB
Diferencial - (dir./esq.) / Diferencial - (der./izq.) / Differential (right/left)			18,500 lb.	496 / 493		TRB
			15,000 lb.	498 / 493		TRB
Diferencial - (esq.) / Diferencial - (izq.) / Differential (left)			17,000 lb.	56425 / 56650		TRB
			18,500 lb.	72200 C / 72487		TRB
Diferencial - pinhão cabeça / Diferencial - piñón cabeza / Differential - pinion head			15,000 lb.	HM 903249 / HM 903210	931482	TRB
			17,000 lb.	55200 C / 55437		TRB
Diferencial - pinhão cola / Diferencial - piñón cola / Differential - pinion rear			18,500 lb.	72188 C / 72487		TRB
		•	Eaton 15,000 lb.	3982 / 3920	94630960	TRB
Roda / Rueda / Wheel		•	Eaton 15,000 lb.	33287 / 33462		TRB
		•	Eaton 17,000 lb.	3982 / 3920	94630960	TRB
		•	Eaton 17,000 lb.	495 AX / 493		TRB
		•	18,500 lb.	39590 / 39520		TRB
		•	18,500 lb.	47686 / 47620	7EQH1238	TRB

Eixo Dianteiro / Eje Delantero / Front Axle

Roda / Rueda / Wheel	•			25880 / 25820		TRB
		•		45284 / 45220		TRB

F-700

Eixo Traseiro / Eje Trasero / Rear Axle

Diferencial - eixo (traseiro) / Diferencial - eje (trasero) / Differential - shaft rear				HM 807040 / HM 807010	71LB4625A1A	TRB
Diferencial (dir.) / Diferencial (der.) / Differential (right)				497 / 493	620244	TRB
Diferencial - (esq.) / Diferencial - (izq.) / Differential (left)				56425 / 56650		TRB

	OUT	IN		Fersa®	N° OEM	
---	-----	----	---	---------------	--------	---

FORD (NA & CA)

F-700

Eixo Traseiro / Eje Trasero / Rear Axle

Diferencial - pinhão cabeça / Diferencial - piñón cabeza / Differential - pinion head				72200 C / 72487		TRB
Diferencial - pinhão cola / Diferencial - piñón cola / Differential - pinion rear				55200 C / 55437		TRB
Roda / Rueda / Wheel	•			580 / 572		TRB
		•		594 A / 592 A	003 9811405	TRB

Eixo Dianteiro / Eje Delantero / Front Axle

Roda / Rueda / Wheel	•			3782 / 3720	B5QM1216A	TRB
		•		HM 212049 / HM 212011		TRB

F-800

Caixa de Mudanças / Caja de Cambios / Gearbox

			Fuller FS 5306 A No. Fuller 1313645 / 791943	25590 / 25522	B7T1201A	TRB
			Fuller FS 5306 A No. Fuller 658981 / 660181	3782 / 3720	B5QM1216A	TRB
			Fuller FS 5306 A No. Fuller 675250 / 742259	39590 / 39520		TRB
			Fuller FS 5306 A No. Fuller 710787	31594 / 31520	9415470/477080	TRB
			Fuller FS 5306 A No. Fuller 711123 / 5202047	45284 / 45220		TRB

LM-700

Eixo Traseiro / Eje Trasero / Rear Axle

Diferencial (dir.) / Diferencial (der.) / Differential (right)				JM 716649 / JM 716610		TRB
Diferencial - pinhão cabeça / Diferencial - piñón cabeza / Differential - pinion head				78225 C / 78551		TRB
Diferencial - pinhão cola / Diferencial - piñón cola / Differential - pinion rear				55206 C / 55437		TRB
Roda / Rueda / Wheel	•			580 / 572		TRB
		•		594 A / 592 A	183704	TRB

Eixo Dianteiro / Eje Delantero / Front Axle

Roda / Rueda / Wheel	•			3782 / 3720	807949	TRB
		•		HM 212047 / HM 212011	C4TA1215B	TRB

LT-800

Eixo Traseiro / Eje Trasero / Rear Axle

Diferencial - lateral (dir./esq.) / Diferencial - lateral (der./izq.) / Differential (right/left)				32021 XF		TRB
Diferencial - pinhão cabeça / Diferencial - piñón cabeza / Differential - pinion head				H 715343 / H 715311	500588901	TRB
Diferencial - pinhão cola / Diferencial - piñón cola / Differential - pinion rear				65237 / 65500		TRB

Eixo Dianteiro / Eje Delantero / Front Axle

Roda / Rueda / Wheel	•			555 S / 552 A		TRB
		•		6461A / 6420		TRB





FREIGHTLINER

ARGOSY

Caixa de Mudanças / Caja de Cambios / Gearbox

Caixa pinhão / Caja piñón / Pinion box				H 715343 / H 715311	500588901	TRB
				HM 813843 / HM 813810		TRB

Eixo Traseiro / Eje Trasero / Rear Axle

Diferencial - (dir./esq.) / Diferencial - (der./izq.) / Differential (right/left)				594 A / 592 A	183704	TRB
Roda / Rueda / Wheel	•			580 / 572		TRB
		•		594 A / 592 A	183704	TRB

Eixo Dianteiro / Eje Delantero / Front Axle

Roda / Rueda / Wheel	•			HM 212047 / HM 212011	C4TA1215B	TRB
		•		3782 / 3720	B5QM1216A	TRB

C-120 * Columbia * Coronado * CST 120

Caixa de Mudanças / Caja de Cambios / Gearbox

Caixa pinhão / Caja piñón / Pinion box				H 715343 / H 715311	500588901	TRB
				HM 813843 / HM 813810		TRB

Eixo Traseiro / Eje Trasero / Rear Axle

Diferencial - (dir./esq.) / Diferencial - (der./izq.) / Differential (right/left)				594 A / 592 A	183704	TRB
Roda / Rueda / Wheel	•			580 / 572		TRB
		•		594 A / 592 A	183704	TRB

Direção / Dirección / Steering

Perno de direção / Perno de dirección / Pintle direction				T 182	DIHA 3123 A2A	TRBT
--	--	--	--	-------	---------------	------

Eixo Dianteiro / Eje Delantero / Front Axle

Roda / Rueda / Wheel	•			3782 / 3720	B5QM1216A	TRB
		•		HM 212049 / HM 212011		TRB

FC 70

Eixo Traseiro / Eje Trasero / Rear Axle

Diferencial - eixo de entrada (dianteiro) / Diferencial - eje de entrada (delantero) / Differential - input shaft (front)				JM 511946 / JM 511910		TRB
Diferencial - eixo de entrada (traseiro) / Diferencial - eje de entrada (trasero) / Differential - input shaft rear				JLM 710949 / JLM 710910		TRB
Diferencial - eixo de saída / Diferencial - eje de salida / Differential - output shaft				LM 104949 / LM 104910		TRB
Diferencial - (dir./esq.) / Diferencial - (der./izq.) / Differential (right/left)				JM 716649 / JM 716610		TRB
Diferencial - pinhão cabeça / Diferencial - piñón cabeza / Differential - pinion head				H 715334 / H 715311	500587901	TRB
Diferencial - pinhão cola / Diferencial - piñón cola / Differential - pinion rear				72212 C / 72487		TRB
Roda / Rueda / Wheel	•		17,000 lb.	39590 / 39520		TRB
		•	17,000 lb.	47686 / 47620	7EQH1238	TRB
		•	Meritor RS-17-145	33287 / 33462		TRB
		•	Meritor RS-17-145	3982 / 3920	94630960	TRB



OUT

IN



Fersa®

N° OEM



FREIGHTLINER

FC 70

Eixo Dianteiro / Eje Delantero / Front Axle

Roda / Rueda / Wheel	•		02...04	25877 / 25820		TRB
		•	02...04	JM 207049 A / JM 207010		TRB
	•		10,000 lb.	3782 / 3720	B5QM1216A	TRB
		•	10,000 lb.	HM 212047 / HM 212011	C4TA1215B	TRB
	•		12,000 lb.	3782 / 3720	B5QM1216A	TRB
		•	12,000 lb.	HM 212049 / HM 212011		TRB

FC 80

Eixo Traseiro / Eje Trasero / Rear Axle

Diferencial (dir.) / Diferencial (der.) / Differential (right)			23,000 lb.	JM 716649 / JM 716610		TRB
Diferencial - (dir./esq.) / Diferencial - (der./izq.) / Differential (right/left)			17,000 / 21,000 lb.	32020 XF	0019816405	TRB
Diferencial - pinhão cabeça / Diferencial - piñón cabeza / Differential - pinion head			17,000 / 21,000 lb.	72212 C / 72487		TRB
			23,000 lb.	78225 C / 78551		TRB
Diferencial - pinhão cola / Diferencial - piñón cola / Differential - pinion rear			17,000, 21,000 / 23,000 lb.	55206 C / 55437		TRB
Roda / Rueda / Wheel	•		Meritor RS-23-240	580 / 572		TRB

Eixo Dianteiro / Eje Delantero / Front Axle

Roda / Rueda / Wheel	•		10,000 lb.	3782 / 3720	B5QM1216A	TRB
		•	10,000 lb.	HM 212047 / HM 212011	C4TA1215B	TRB
	•		12,000 lb.	3782 / 3720	B5QM1216A	TRB
		•	12,000 lb.	HM 212049 / HM 212011		TRB

FL 106

Eixo Dianteiro / Eje Delantero / Front Axle

Roda / Rueda / Wheel	•			3782 / 3720	B5QM1216A	TRB
		•		HM 212049 / HM 212011		TRB

Eixo Traseiro / Eje Trasero / Rear Axle

Roda / Rueda / Wheel	•			39590 / 39520		TRB
		•		47686 / 47620	7EQH1238	TRB

FL 112 6X4



Eixo Dianteiro / Eje Delantero / Front Axle

Roda / Rueda / Wheel	•			3782 / 3720	B5QM1216A	TRB
		•		HM 212049 / HM 212011		TRB
	•		29,000 lb.	555 S / 552 A		TRB
		•	29,000 lb.	6461A / 6420		TRB

FL 112QR 6X4

Eixo Traseiro / Eje Trasero / Rear Axle

Diferencial / Diferencial / Differential			RD-20-145 / RP-20-145 DIF Lock	72212 C / 72487		TRB
			RD-20-145 / RP-20-145 DIF Lock Rockwell RT- 40/44-145	JLM 710949 C / JLM 710910		TRB
			RD-20-145 / RP-20-145 DIF Lock	JM 716649 / JM 716610		TRB
Diferencial - (dir./esq.) / Diferencial - (der./izq.) / Differential (right/left)				594 A / 592 A	183704	TRB

	OUT	IN		Fersa®	Nº OEM	
---	-----	----	---	---------------	--------	---

FREIGHTLINER

FL 112QR 6X4

Diferencial - pinhão cabeça / Diferencial - piñón cabeza / Differential - pinion head			Rockwell RT-40/44-145 RD-20-145 / RP-20-145	H 715334 / H 715311	500587901	TRB
Diferencial - pinhão cola / Diferencial - piñón cola / Differential - pinion rear			Rockwell RT-40/45-145 RR-20-145 DIF Lock	55206 C / 55437		TRB
Roda / Rueda / Wheel	•		Meritor RT-40-160	580 / 572		TRB
		•	Meritor RT-40-160	594 A / 592 A	183704	TRB

Eixo Dianteiro / Eje Delantero / Front Axle

Roda / Rueda / Wheel	•		FL-941, 20,000 lb.	555 S / 552 A		TRB
		•	FL-941, 20,000 lb.	6461A / 6420		TRB
		•	FF-961, 13,000 lb.	HM 212049 / HM 212011		TRB

FL 60

Caixa de Mudanças / Caja de Cambios / Gearbox

			Fuller FS5205A	25580 / 25520		TRB
			Fuller FS5205A	M 804049 / M 804010		TRB
			Fuller FS5205A	M 802048 / M 802011		TRB
			Fuller FS5205A No. Fuller 654166 / 791943	25590 / 25520		TRB

Eixo Traseiro / Eje Trasero / Rear Axle

Diferencial (dir.) / Diferencial (der.) / Differential (right)			13,000 / 15,000 lb.	34306 / 34478		TRB
Diferencial - pinhão cabeça / Diferencial - piñón cabeza / Differential - pinion head			13,000 / 15,000 lb.	55200 C / 55437		TRB
Diferencial - pinhão cola / Diferencial - piñón cola / Differential - pinion rear			13,000 / 15,000 lb.	HM 804846 / HM 804810		TRB
Roda / Rueda / Wheel	•		17,000 lb.	33287 / 33462		TRB
		•	17,000 lb.	3982 / 3920	94630960	TRB

Eixo Dianteiro / Eje Delantero / Front Axle

Roda / Rueda / Wheel	•		10,000 lb.	25877 / 25820		TRB
		•	10,000 lb.	JM 207049 A / JM 207010		TRB

FL 70

Caixa de Mudanças / Caja de Cambios / Gearbox

			Fuller FS5205A	25580 / 25520		TRB
			Fuller FS5205A	M 804049 / M 804010		TRB
			Fuller FS5205A	M 802048 / M 802011		TRB
			Fuller FS5205A	25590 / 25520		TRB

Eixo Traseiro / Eje Trasero / Rear Axle

Diferencial (dir.) / Diferencial (der.) / Differential (right)			Rockwell 17,000 lb.	JLM 714149 / JLM 714110	3459817118	TRB
			Rockwell 21,000 / 23,000 lb.	JM 716649 / JM 716610		TRB
Diferencial - (esq.) / Diferencial - (izq.) / Differential (left)			Rockwell 17,000 lb.	42381 / 42584	3315955	TRB
			Rockwell 21,000 lb.	52400 / 52618		TRB

	OUT	IN		Fersa®	N° OEM	
---	-----	----	---	---------------	--------	---

FREIGHTLINER

FL 70

Diferencial - pinhão cabeça / Diferencial - piñón cabeza / Differential - pinion head			Rockwell 17,000 lb.	M 804049 / M 804010		TRB
			Rockwell 21,000 lb.	HM 804846 / HM 804810		TRB
			Rockwell 23,000 lb.	78225 C / 78551		TRB
Diferencial - pinhão cola / Diferencial - piñón cola / Differential - pinion rear			Rockwell 17,000 / 21,000 lb.	55200 C / 55437		TRB
			Rockwell 23,000 lb.	55206 C / 55437		TRB
Roda / Rueda / Wheel	•		Meritor RR-17-145	39590 / 39520		TRB
		•	Meritor RR-17-145	47686 / 47620	7EQH1238	TRB
	•		Meritor RS-23-240, 40 Ton.	580 / 572		TRB
		•	Meritor RS-23-240, 40 Ton.	594 A / 592 A	183704	TRB

Eixo Dianteiro / Eje Delantero / Front Axle

Roda / Rueda / Wheel	•		10,000 lb.	3782 / 3720	B5QM1216A	TRB
		•	10,000 lb.	HM 212047 / HM 212011	C4TA1215B	TRB
	•		12,000 lb.	3782 / 3720	B5QM1216A	TRB
		•	12,000 lb.	HM 212049 / HM 212011		TRB

FL 80 * FL 80 QR 4X2

Caixa de Mudanças / Caja de Cambios / Gearbox

			Fuller FS5406	25590 / 25522	B7T1201A	TRB
			Fuller FS5406	45520		TRB
			Fuller FS5406	39590 / 39520		TRB
			Fuller FS5406	31594 / 31520	9415470/477080	TRB
			Fuller FS5406	3782 / 3720	B5QM1216A	TRB
			Fuller FS 6305 A No. Fuller 1313645 / 791943	25590 / 25522	B7T1201A	TRB
			Fuller FS 6305 A No. Fuller 658981 / 660181	3782 / 3720	B5QM1216A	TRB
			Fuller FS 6305 A No. Fuller 675250 / 742259	39590 / 39520		TRB
			Fuller FS 6305 A No. Fuller 710787	31594 / 31520	9415470/477080	TRB

Eixo Dianteiro / Eje Delantero / Front Axle

Roda / Rueda / Wheel	•		10,000 lb.	3782 / 3720	B5QM1216A	TRB
		•	10,000 lb.	HM 212047 / HM 212011	C4TA1215B	TRB
	•		12,000 lb.	3782 / 3720	B5QM1216A	TRB
		•	12,000 lb.	HM 212049 / HM 212011		TRB

Eixo Traseiro / Eje Trasero / Rear Axle

Roda / Rueda / Wheel	•		Meritor RS-23-240 * RT-44-145, 40 Ton.	580 / 572		TRB
		•	Meritor RS-23-240 * RT-44-145, 40 Ton.	594 A / 592 A	183704	TRB

FLD 120

Eixo Traseiro / Eje Trasero / Rear Axle

Diferencial / Diferencial / Differential			RD-20-145 / RP-20-145 DIF LOCK	H 715343 / H 715311	500588901	TRB
			RD-20-145 / RP-20-145 DIF LOCK	H 715334 / H 715311	500587901	TRB
Diferencial - flecha de entrada / Diferencial - flecha de entrada / Differential - input shaft			Dirona	JH 211749 / JH 211710	23336042	TRB
Diferencial - flecha de saída / Diferencial - flecha de saída / Differential - output shaft			Dirona	LM 104949 / LM 104910		TRB

	OUT	IN		Fersa®	Nº OEM	
---	-----	----	---	---------------	--------	---

FREIGHTLINER

FLD 120

Diferencial - interdiferencial / Diferencial - interdiferencial / Differential - interdiffereñtial			Dirona	JLM 714149 / JLM 714110	3459817118	TRB
Diferencial - (dir./esq.) / Diferencial - (der./izq.) / Differential (right/left)			Dirona	47890 / 47820		TRB
Diferencial - nariz pinhão / Diferencial - nariz piñón / Differential - pinion			Dirona	F 19034		CRBS
Diferencial - pinhão cola / Diferencial - piñón cola / Differential - pinion rear				65237 / 65500		TRB
Roda / Rueda / Wheel	•			580 / 572		TRB
		•		594 A / 592 A	183704	TRB

Eixo Dianteiro / Eje Delantero / Front Axle

Roda / Rueda / Wheel	•		FF-961, 13,000 lb.	3782 / 3720	B5QM1216A	TRB
		•	FF-961, 13,000 lb.	HM 212049 / HM 212011		TRB

Direção / Dirección / Steering

Perno de direção / Perno de dirección / Pintle direction				T 182	DIHA 3123 A2A	TRBT
--	--	--	--	--------------	---------------	------

FS 65

Caixa de Mudanças / Caja de Cambios / Gearbox

			Fuller FS5205A	25580 / 25520		TRB
			Fuller FS5205A	M 804049 / M 804010		TRB
			Fuller FS5205A	M 802048 / M 802011		TRB
			Fuller FS5205A No. Fuller 654166 / 791943	25590 / 25520		TRB
			Fuller FS 6406 A No. Fuller 1313645 / 791943	25590 / 25522	B7T1201A	TRB
			Fuller FS 6406 A No. Fuller 658981 / 660181	3782 / 3720	B5QM1216A	TRB
			Fuller FS 6406 A No. Fuller 675250 / 742259	39590 / 39520		TRB
			Fuller FS 6406 A	31594 / 31520	9415470/477080	TRB
			Fuller FS 6406 A No. Fuller 711123 / 5202047	45284 / 45220		TRB

Eixo Traseiro / Eje Trasero / Rear Axle

Diferencial - flecha de entrada / Diferencial - flecha de entrada / Differential - input shaft			Rockwell SSHD	JH 211749 / JH 211710	23336042	TRB
Diferencial - flecha de saída / Diferencial - flecha de salida / Differential - output shaft			Rockwell SSHD	LM 104949 / LM 104910		TRB
Diferencial - interdiferencial / Diferencial - interdiferencial / Differential - interdiffereñtial			Rockwell SSHD 46,000	JLM 714149 / LM 714110	3459817118	TRB
Diferencial - (dir./esq.) / Diferencial - (der./izq.) / Differential (right/left)			Rockwell SSHD 46,000 lb.	47890 / 47820		TRB
Diferencial - nariz pinhão / Diferencial - nariz piñón / Differential - pinion			Rockwell SSHD 46,000 lb.	F 19034		CRBS
Diferencial - pinhão cabeça / Diferencial - piñón cabeza / Differential - pinion head			Rockwell SSHD 46,000	H 715343 / H 715311	500588901	TRB
Diferencial - pinhão cola / Diferencial - piñón cola / Differential - pinion rear			Rockwell SSHD 46,000 lb.	65237 / 65500		TRB
			Rockwell SSHD 46,000 lb.	H 715334 / H 715311	500587901	TRB
Roda / Rueda / Wheel	•		19,000 lb.	39590 / 39520		TRB
		•	19,000 lb.	47686 / 47620	7EQH1238	TRB
	•			580 / 572		TRB
		•		594 A / 592 A	183704	TRB

	OUT	IN		Fersa [®]	N° OEM	
---	-----	----	---	---------------------------	--------	---

FREIGHTLINER

FS 65

Eixo Dianteiro / Eje Delantero / Front Axle

Roda / Rueda / Wheel	•		10,000 lb.	3782 / 3720	B5QM1216A	TRB
		•	10,000 lb.	HM 212047 / HM 212011	C4TA1215B	TRB
	•		12,000 lb.	3782 / 3720	B5QM1216A	TRB
		•	12,000 lb.	HM 212049 / HM 212011		TRB

L-112

Eixo Traseiro / Eje Trasero / Rear Axle

Diferencial (dir.) / Diferencial (der.) / Differential (right)			Rockwell RT-40-145 * Carrier 3200- G-1879	JM 716649 / JM 716610		TRB
Diferencial - pinhão cabeça / Diferencial - piñón cabeza / Differential - pinion head			Rockwell RT-40-145 * Carrier 3200- G-1879	72212 C / 72487		TRB
Diferencial - pinhão cola / Diferencial - piñón cola / Differential - pinion rear			Rockwell RT-40-145 * Carrier 3200- G-1879	55206 C / 55437		TRB
Roda / Rueda / Wheel	•			580 / 572		TRB
		•		594 A / 592 A	183704	TRB

Eixo Dianteiro / Eje Delantero / Front Axle

Roda / Rueda / Wheel	•			3782 / 3720	B5QM1216A	TRB
		•		HM 212049 / HM 212011		TRB

MT45 * MT45A. M2 52K 6X2



Caixa de Mudanças / Caja de Cambios / Gearbox

			Fuller FS5406	25590 / 25522	B7T1201A	TRB
			Fuller FS5205A	25590 / 25520		TRB
			Fuller FS5406 No Fuller 711123	45520		TRB
			Fuller FS5406	39590 / 39520		TRB
			Fuller FS5406	31594 / 31520	9415470/477080	TRB
			Fuller FS5406	3782 / 3720	B5QM1216A	TRB

Eixo Dianteiro / Eje Delantero / Front Axle

Roda / Rueda / Wheel	•			25877 / 25820		TRB
		•		JM 207049 A / JM 207010		TRB



	OUT	IN		Fersa®	Nº OEM	
---	-----	----	---	---------------	--------	---

GENERAL MOTORS (SA)

6-100 (4X2) * 6-150 * 12-170 L * S (4X2) * 14-190 (77...) (4X2) * 15-190 (77...) (4X2) * 16-220 (4X2)

Caixa de Mudanças / Caja de Cambios / Gearbox

Eixo intermediário (dianteiro) / Eje intermedio (delantero) / Intermediate shaft (front)				3782 / 3720	7326379/94632998	TRB
Eixo Intermediário (dianteiro / traseiro) / Eje Intermedio (delantero / trasero) / Intermediate shaft (front / rear)			6-100 4x2 Maxion S-4 * Eaton FS 2305 C	25877 / 25821		TRB
Eixo intermediário (dir.) / Eje intermedio (der.) / Intermediate shaft (right)			15-190 (77...) (4x2) Caterpillar-3116 * Eaton FS 5306 A * 16-220 (4x2) Caterpillar-3116 * Eaton FS 6306 A	25590 / 25522		TRB
			12-170 L/S (4x2) Caterpillar-3116 * Eaton FS 4205 A * 14-190 (77...) (4x2) Caterpillar-3116 * Eaton FS 5205 A	25877 / 25821		TRB
Eixo primário / Eje primario / Primary shaft			15-190 (77...) (4x2) Caterpillar-3116 * Eaton FS 5306 A * 16-220 (4x2) Caterpillar-3116 * Eaton FS 6306 A	39590 / 39520		TRB
			6-100 (4x2) Maxion S-4 * Eaton FS 2305 C * 12-170 L/S (4x2) Caterpillar-3116 * Eaton FS 4205	M 802048 / M 802011		TRB
Eixo primário (dianteiro) / Eje primario (delantero) / Primary shaft (front)				M 802048 / M 802011		TRB
Eixo primário (traseiro) / Eje primario (trasero) / Primary shaft rear				39590 / 39520		TRB
Eixo secundário (dianteiro) / Eje secundario (delantero) / Secondary shaft (front)			6-100 (4x2) Maxion S-4 * Eaton FS 2305 C	M 802048 / M 802011		TRB

Eixo Traseiro / Eje Trasero / Rear Axle

Diferencial - lateral / Diferencial - lateral / Differential - crown gear			16-220 (4x2) Caterpillar-3116 * Eaton 23080 TR - Argentina	42381 / 42584		TRB
Diferencial - lateral coroa (dir./esq.) / Diferencial - lateral corona (der./izq.) / Differential - crown gear (right/left)			6-100 (4x2) Maxion S-4 * Dana 1410 * 6-150 Maxion 6.07 THD * Dana 1410	387 A / 382 A		TRB
				387 A / 382 A		TRB
Diferencial - lateral coroa (dir.) / Diferencial - lateral corona (der.) / Differential - crown gear (right)			12-170 L/S (4x2) * 14-190 (77...) (4x2) Caterpillar-3116 * Eaton 23060 TR - Argentina	497 / 493		TRB
Diferencial - lateral coroa (esq.) / Diferencial - lateral corona (izq.) / Differential - crown gear (left)			12-170 L/S (4x2) * 14-190 (77...) (4x2) Caterpillar-3116 * Eaton 23060 TR - Argentina	56425 / 56650		TRB
Diferencial - pinhão (dianteiro) / Diferencial - piñón (delantero) / Differential - pinion (front)			6-100 (4x2) Maxion S-4 * Dana 1410 * 6-150 Maxion 6.07 THD * Dana 1410	HM 807046 / HM 807010		TRB
Roda / Rueda / Wheel		•		3982 / 3920		TRB
		•		594 / 592 A		TRB
	•			368 A / 362 A		TRB
	•			580 / 572		TRB

Eixo Dianteiro / Eje Delantero / Front Axle

Roda / Rueda / Wheel		•		LM 501349 / LM 501310	00457233	TRB
	•			32307 F		TRB
	•			33208 F		TRB
	•			2780 / 2720	94223337	TRB

	OUT	IN		Fersa®	N° OEM	
---	-----	----	---	---------------	--------	---

GENERAL MOTORS (SA)

6-100 (4X2) * 6-150 * 12-170 L * S (4X2) * 14-190 (77...) (4X2) * 15-190 (77...) (4X2) * 16-220 (4X2)

Motor / Motor / Engine

Polia tensora - coletor / Polea tensora - colector / Tensioner pulley - collector				6205 Z	94642765	BB
--	--	--	--	---------------	----------	----

A-C-D 60 * 70 * 80 * 90 * 99 Turbo e 3500 Heavy Duty

Caixa de Mudanças / Caja de Cambios / Gearbox

Eixo intermediário (traseiro) / Eje intermedio (trasero) / Intermediate shaft rear			Fuller seco	6307 ZNR		BB
			Fuller sincrono	6308 ZNR		BB
Eixo primário / Eje primario / Primary shaft			Fuller seco	6211 ZNR		BB
Eixo primário (dianteiro) / Eje primario (delantero) / Primary shaft (front)			85...	M 802048 / M 802011		TRB
Eixo secundário (traseiro) / Eje secundario (trasero) / Secondary shaft rear				6308 N		BB
			Fuller seco	6308 NR		BB
			Fuller sincrono	6309 NR		BB

Eixo Traseiro / Eje Trasero / Rear Axle

Diferencial - eixo reduzida (dir.) / Diferencial - eje reducción (der.) / Differential - reduction shaft (right)				HM 807046 / HM 807010		TRB
Diferencial - eixo reduzida (esq.) / Diferencial - eje reducción (izq.) / Differential - reduction shaft (left)				HM 807040 / HM 807010		TRB
Diferencial - pinhão (dianteiro) / Diferencial - piñón (delantero) / Differential - pinion (front)				M 802048 / M 802011	9418356	TRB
Diferencial - pinhão (traseiro) / Diferencial - piñón (trasero) / Differential - pinion rear				HM 807046 / HM 807010		TRB
Roda / Rueda / Wheel				33287 / 33462	457439	TRB
	•			39590 / 39520	7451070	TRB
		•		45284 / 45220	7451119	TRB
			•	47686 / 47620	446051	TRB

Eixo Dianteiro / Eje Delantero / Front Axle

Roda / Rueda / Wheel		•		25590 / 25522	7319663	TRB
		•		45284 / 45220	7451119	TRB
	•			15106 / 15250 X	7319666	TRB
	•			2780 / 2720	94223337	TRB

Motor / Motor / Engine

Alternador (dianteiro) / Alternador (delantero) / Alternator (front)			A 60 * C 60 * D 60 Perkins * 67...	6203 2RS		BB
Dínamo (dianteiro) / Dinamo (delantero) / Dynamo (front)			C 60 (64...66)	6203 2RS		BB
Polia tensora - coletor / Polea tensora - colector / Tensioner pulley - collector				6205 ZZ	94642765	BB



	OUT	IN		Fersa®	Nº OEM	
---	-----	----	---	---------------	--------	---

GENERAL MOTORS (NA & CA)

C-3500

Eixo Traseiro / Eje Trasero / Rear Axle

Diferencial (dir.) / Diferencial (der.) / Differential (right)			17,000 * 22,000 lb.	497 / 493		TRB
Diferencial - (dir./esq.) / Diferencial - (der./izq.) / Differential (right/left)				HM 903249 / HM 903210		TRB
Diferencial - (esq.) / Diferencial - (izq.) / Differential (left)			17,000 * 22,000 lb.	56425 / 56650		TRB
Diferencial - pinhão cabeça / Diferencial - piñón cabeza / Differential - pinion head				387 AS / 382 A		TRB
			22,000 lb.	72200 C / 72487		TRB
Diferencial - pinhão (cabeza - cola) / Diferencial - piñón (cabeza/cola) / Differential - pinion (head rear)			17,000 * 22,000 lb.	55200 C / 55437		TRB
Diferencial - pinhão cola / Diferencial - piñón cola / Differential - pinion rear				M 802048 / M 802011		TRB
Roda / Rueda / Wheel	•			LM 104949 / LM 104911		TRB
		•		387 AS / 382 A		TRB

Eixo Dianteiro / Eje Delantero / Front Axle

Roda / Rueda / Wheel	•			15103S / 15243		TRB
		•		LM 501349 / LM 501310		TRB

Kodiak

Caixa de Mudanças / Caja de Cambios / Gearbox

			Fuller FS5205A No Fuller 654166, 237227 / Diesel	25580 / 25520		TRB
			Fuller FS5205A No. Fuller 235417, 235416 / Diesel	M 804049 / M 804010		TRB
			Fuller FS5205A No. Fuller 1314774, 1314773 / Diesel	M 802048 / M 802011	4001035070006	TRB
			Fuller FS5205A No. Fuller 654166 / 791943 / Diesel	25590 / 25520		TRB
			Fuller FS 5306 A No. Fuller1313645 / 791943 / Diesel	25590 / 25522		TRB
			Fuller FS 5306 A No. Fuller 658981 / 660181 / Diesel	3782 / 3720		TRB
			Fuller FS 5306 A No. Fuller675250 / 742259 / Diesel	39590 / 39520		TRB
			Fuller FS 5306 A No. Fuller 710787, Diesel	31594 / 31520		TRB
			Fuller FS 5306 A No. Fuller 711123 / 5202047 / Diesel	45284 / 45220		TRB
			Tremec FS 5005 No. Fuller 235417, 235418 / Diesel	M 804049 / M 804010		TRB
			Tremec FS 5005 No. Fuller 654166, 791943 / Diesel	25590 / 25520		TRB
			Tremec FSM 5005 No. Fuller 235417, 235418 / Diesel	M 804049 / M 804010		TRB
			Tremec FSM 5005	25590 / 25520		TRB

	OUT	IN		Fersa®	Nº OEM	
---	-----	----	---	---------------	--------	---

INTERNATIONAL (NA & CA)

4700

Eixo Traseiro / Eje Trasero / Rear Axle

Diferencial (dir.) / Diferencial (der.) / Differential (right)			22065T / R22000	497 / 493		TRB
Diferencial - (esq.) / Diferencial - (izq.) / Differential (left)			22065T / R22000	56425 / 56650		TRB
Diferencial - pinhão cola / Diferencial - piñón cola / Differential - pinion rear			22065T / R22000	55200 C / 55437		TRB

Eixo Dianteiro / Eje Delantero / Front Axle

Roda / Rueda / Wheel		•		3782 / 3720	807949	TRB
----------------------	--	---	--	--------------------	--------	-----

7400

Eixo Dianteiro / Eje Delantero / Front Axle

Roda / Rueda / Wheel	•			3782 / 3720	807949	TRB
		•		HM 212049 / HM 212011		TRB

Eixo Traseiro / Eje Trasero / Rear Axle

Roda / Rueda / Wheel	•			580 / 572		TRB
		•		594 A / 592 A	0039811405 / 183704	TRB

4200 VT 365 * 4300 DT 466 / 195 HP

Caixa de Mudanças / Caja de Cambios / Gearbox

			654166, 237227 / Diesel	25580 / 25520		TRB
			Fuller FS5205A No. Fuller 235417, 235416 / Diesel	M 804049 / M 804010		TRB
			Fuller FS5205A No. Fuller 1314774, 1314773 / Diesel	M 802048 / M 802011		TRB
			Fuller FS5205A No. Fuller 654166 / 791943 / Diesel	25590 / 25520	9414069	TRB
			Fuller FS5406	25590 / 25522		TRB
			Fuller FS5406	45520		TRB
			Fuller FS5406	39590 / 39520		TRB
			Fuller FS5406	31594 / 31520		TRB
			Fuller FS5406	3782 / 3720	807949	TRB
			Fuller FS 6305 A No. Fuller 1313645 / 791943	25590 / 25522		TRB
			Fuller FS 6305 A No. Fuller 658981 / 660181	3782 / 3720	807949	TRB
			Fuller FS 6305 A No. Fuller 675250 / 742259	39590 / 39520		TRB
			Fuller FS 6305 A No. Fuller 4400-215HP 4X2, 4400-250HP, 4400- 285HP, 4400-300HP	31594 / 31520		TRB

Eixo Dianteiro / Eje Delantero / Front Axle

Roda / Rueda / Wheel	•		10,000 lb.	3782 / 3720	807949	TRB
		•	10,000 lb.	HM 212049 / HM 212011		TRB

Eixo Traseiro / Eje Trasero / Rear Axle

Roda / Rueda / Wheel	•		23,000 lb.	580 / 572		TRB
		•	23,000 lb.	594 A / 592 A	0039811405 / 183704	TRB

	OUT	IN		Fersa®	N° OEM	
---	-----	----	---	---------------	--------	---

INTERNATIONAL (NA & CA)

4400-215HP 4X2 * 4400-250HP * 4400-285HP * 4400-300HP

Caixa de Mudanças / Caja de Cambios / Gearbox

			Fuller FS 6305 A No. Fuller 1313645 / 791943	25590 / 25522		TRB
			Fuller FS 6305 A No. Fuller 658981 / 660181	3782 / 3720	807949	TRB
			Fuller FS 6305 A No. Fuller 675250 / 742259	39590 / 39520		TRB
			Fuller FS 6305 A	31594 / 31520		TRB

Eixo Traseiro / Eje Trasero / Rear Axle

Diferencial - eixo intermedio de entrada / Diferencial - eje intermedio de entrada / Differential - input intermediate shaft			Dana Spicer DS 405	555 S / 552 A		TRB
Diferencial - eixo intermedio de saída / Diferencial - eje intermedio de salida / Differential - output intermediate shaft			Dana Spicer DS 405	29675 / 29630		TRB
Diferencial (dir.) / Diferencial (der.) / Differential (right)				JM 716649 / JM 716610		TRB
			Dana Spicer DS 405 / RS405	497 / 493		TRB
Diferencial - (esq.) / Diferencial - (izq.) / Differential (left)			Dana Spicer DS 405 / RS405	567 / 563	354821 / 658623	TRB
Diferencial - pinhão cabeça / Diferencial - piñón cabeza / Differential - pinion head				78225 C / 78551		TRB
			Dana Spicer RS 405 / DS	72212 C / 72487		TRB
Diferencial - pinhão cola / Diferencial - piñón cola / Differential - pinion rear				55206 C / 55437		TRB
			Dana Spicer DS 405	55200 C / 55437		TRB
Roda / Rueda / Wheel	•		23,000 lb.	580 / 572		TRB
		•	23,000 lb.	594 A / 592 A	0039811405 / 183704	TRB

Eixo Dianteiro / Eje Delantero / Front Axle

Roda / Rueda / Wheel	•		12,000 lb.	3782 / 3720	807949	TRB
		•	12,000 lb.	HM 212049 / HM 212011		TRB

4900 DT 466E

Eixo Traseiro / Eje Trasero / Rear Axle

Diferencial - (dir./esq.) / Diferencial - (der./izq.) / Differential (right/left)				47890 / 47820	181608 / 590762	TRB
Diferencial - nariz pinhão / Diferencial - nariz piñón / Differential - pinion			Rockwell SSHD 46,000 lb.	F 19034		CRBS
Diferencial - pinhão cabeça / Diferencial - piñón cabeza / Differential - pinion head				H 715334 / H 715311	500587901	TRB
Diferencial - pinhão cola / Diferencial - piñón cola / Differential - pinion rear				H 715343 / H 715311	500588901	TRB
Roda / Rueda / Wheel	•			580 / 572		TRB
		•		594 A / 592 A	0039811405 / 183704	TRB



Eixo Dianteiro / Eje Delantero / Front Axle

Roda / Rueda / Wheel	•			3782 / 3720	807949	TRB
		•		HM 212049 / HM 212011		TRB

4900-210HP * 4900-215HP * 4900-250HP * 4900-300HP

Eixo Dianteiro / Eje Delantero / Front Axle

Roda / Rueda / Wheel	•		12,000 lb.	3782 / 3720	807949	TRB
		•	12,000 lb.	HM 212049 / HM 212011		TRB

	OUT	IN		Fersa®	Nº OEM	
---	-----	----	---	---------------	--------	---

INTERNATIONAL (NA & CA)

4900-210HP * 4900-215HP * 4900-250HP * 4900-300HP

Eixo Traseiro / Eje Trasero / Rear Axle

Roda / Rueda / Wheel	•		23,000 lb.	580 / 572		TRB
		•	23,000 lb.	594 A / 592 A	0039811405 / 183704	TRB

9200 * 9200i * 9400 * 9400i * Day Cab * Day Cab DDC

Eixo Dianteiro / Eje Delantero / Front Axle

Roda / Rueda / Wheel	•		13,200 lb.	3782 / 3720	807949	TRB
		•	13,200 lb.	HM 212047 / HM 212011	C4TA1215B	TRB
	•		12,000 lb.	3782 / 3720	807949	TRB
		•	12,000 lb.	HM 212049 / HM 212011		TRB

Eixo Traseiro / Eje Trasero / Rear Axle

Roda / Rueda / Wheel	•		44,000 lb.	580 / 572		TRB
		•	44,000 lb.	594 A / 592 A	0039811405 / 183704	TRB

IVECO

160 E21

Eixo Traseiro / Eje Trasero / Rear Axle

Diferencial - pinhão (dianteiro) / Diferencial - (piñón delantero) / Differential - pinion (front)				78225 C / 78551		TRB
---	--	--	--	------------------------	--	-----

Daily I 59-12 * Turbo Daily (...12/99)

Eixo Dianteiro / Eje Delantero / Front Axle

Roda / Rueda / Wheel				F 300006		CWT
----------------------	--	--	--	-----------------	--	-----

Eurotrakker * Power Star 450 E37T * Eurotech E37

Caixa de Mudanças / Caja de Cambios / Gearbox

Eixo intermediário / Eje intermedio / Intermediate shaft				F 19010		CRBS
				F 19039		CRBS
Eixo intermediário (dianteiro) / Eje intermedio (delantero) / Intermediate shaft (front)				F 15047	0019801402	STRB



	OUT	IN		Fersa [®]	N° OEM	
---	-----	----	---	---------------------------	--------	---

KENWORTH

T2000

Eixo Traseiro / Eje Trasero / Rear Axle

Diferencial - flecha de entrada / Diferencial - flecha de entrada / Differential - input shaft			Rockwell SSHD 46,000 lb.	JH 211749 / JH 211710	073 5370606	TRB
Diferencial - flecha de saída / Diferencial - flecha de saída / Differential - output shaft			Rockwell SSHD 46,000 lb.	LM 104949 / LM 104910		TRB
Diferencial - interdiferencial / Diferencial - interdiferencial / Differential - interdifferential			Rockwell SSHD 46,000 lb.	JLM 714149 / JLM 714110	735370574	TRB
Diferencial - (dir./esq.) / Diferencial - (der./izq.) / Differential (right/left)			Rockwell SSHD 46,000 lb.	47890 / 47820		TRB
Diferencial - nariz pinhão / Diferencial - nariz piñón / Differential - pinion			Rockwell SSHD 46,000 lb.	F 19034		CRBS
Diferencial - pinhão cabeça / Diferencial - piñón cabeça / Differential - pinion head			Rockwell SSHD 46,000 lb.	H 715343 / H 715311	500588901	TRB
Diferencial - pinhão cola / Diferencial - piñón cola / Differential - pinion rear			Rockwell SSHD 46,000 lb. Tandem	H 715334 / H 715311	500587901	TRB
			Rockwell SSHD 46,000 lb.	65237 / 65500	8Q4625A	TRB
Roda / Rueda / Wheel	•		40,000 lb.	580 / 572		TRB
		•	40,000 lb.	594 A / 592 A	183704	TRB

Eixo Dianteiro / Eje Delantero / Front Axle

Roda / Rueda / Wheel	•		10,000 lb.	3782 / 3720	807949	TRB
		•	10,000 lb.	HM 212047 / HM 212011	C4TA1215B	TRB
	•		12,000 lb.	3782 / 3720	807949	TRB
		•	12,000 lb.	HM 212049 / HM 212011		TRB

T300 4X2 * 6X4

Caixa de Mudanças / Caja de Cambios / Gearbox

			Fuller FS 6305 A No. Fuller 1313645 / 791943	25590 / 25522		TRB
			Fuller FS 6305 A No. Fuller 658981 / 660181	3782 / 3720	807949	TRB
			Fuller FS 6305 A	39590 / 39520		TRB
			Fuller FS 6305 A	31594 / 31520		TRB
			Fuller FS 5306 A No. Fuller 1313645 / 791943	25590 / 25522		TRB
			Fuller FS 5306 A No. Fuller 658981 / 660181	3782 / 3720	807949	TRB
			Fuller FS 5306 A No. Fuller 675250 / 742259	39590 / 39520		TRB
			Fuller FS 5306 A	31594 / 31520		TRB
			Fuller FS 5306 A	45284 / 45220		TRB

Eixo Traseiro / Eje Trasero / Rear Axle

Diferencial (dir.) / Diferencial (der.) / Differential (right)			Eaton DS 405	497 / 493		TRB
Diferencial - (dir./esq.) / Diferencial - (der./izq.) / Differential (right/left)			Rockwell SSHD 46,000	47890 / 47820		TRB
Diferencial - nariz pinhão / Diferencial - nariz piñón / Differential - pinion			Rockwell SSHD 46,000 lb.	F 19034		CRBS
Diferencial - pinhão cabeça / Diferencial - piñón cabeça / Differential - pinion head			Rockwell SSHD 46,000 lb.	H 715343 / H 715311	500588901	TRB
Diferencial - pinhão cola / Diferencial - piñón cola / Differential - pinion rear			Rockwell SSHD 46,000 lb.	H 715334 / H 715311	500587901	TRB

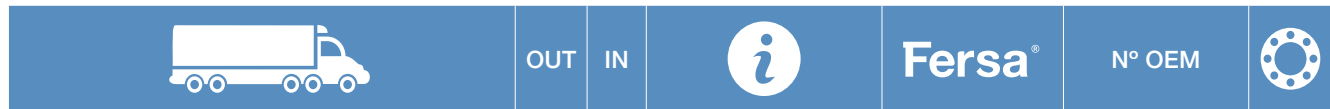

KENWORTH

T300 4X2 * 6X4

Eixo Traseiro / Eje Trasero / Rear Axle

			Rockwell SSHD 46,000 lb.	65237 / 65500	8Q4625A	TRB
Diferencial - (esq.) / Diferencial - (lq.) / Differential (left)			Eaton DS 405	598 A / 592 A		TRB
			Eaton DS 405	567 / 563	658623	TRB
Diferencial - pinhão cabeça / Diferencial - piñón cabeza / Differential - pinion head			Eaton DS 405	72212 C / 72487		TRB
			Eaton DS 405	H 914841 / H 914811		TRB
Diferencial - pinhão cola / Diferencial - piñón cola / Differential - pinion rear			Eaton DS 405	55200 C / 55437		TRB
Roda / Rueda / Wheel	•		21,000 lb.	580 / 572		TRB
		•	21,000 lb.	594 A / 592 A	183704	TRB
	•		40,000 lb.	580 / 572		TRB
		•	40,000 lb.	594 A / 592 A	183704	TRB
	•		46,000 lb.	580 / 572		TRB
		•	46,000 lb.	594 A / 592 A	183704	TRB

Eixo Dianteiro / Eje Delantero / Front Axle

Roda / Rueda / Wheel	•		12,000 lb.	3782 / 3720	807949	TRB
		•	12,000 lb.	HM 212049 / HM 212011		TRB

T 600 Aerocab * B * Modular

Eixo Traseiro / Eje Trasero / Rear Axle

Diferencial - flecha de entrada / Diferencial - flecha de entrada / Differential - input shaft			Rockwell SSHD 46,000 lb.	JH 211749 / JH 211710	073 5370606	TRB
Diferencial - flecha de saída / Diferencial - flecha de salida / Differential - output shaft			Rockwell SSHD 46,000 lb.	LM 104949 / LM 104910		TRB
Diferencial - interdiferencial / Diferencial - interdiferencial / Differential - interdifferential			Rockwell SSHD 46,000 lb.	JLM 714149 / JLM 714110	735370574	TRB

T450 * T450 B * T450 W

Eixo Traseiro / Eje Trasero / Rear Axle

Diferencial (dir.) / Diferencial (der.) / Differential (right)				JM 716649 / JM 716610		TRB
Diferencial - (esq.) / Diferencial - (lq.) / Differential (left)				52400 / 52618		TRB
Diferencial - pinhão cabeça / Diferencial - piñón cabeza / Differential - pinion head				55200 C / 55437		TRB
Diferencial - pinhão cola / Diferencial - piñón cola / Differential - pinion rear				HM 804846 / HM 804810		TRB

Direção / Dirección / Steering

Perno de direção / Perno de dirección / Pintle direction				T 182	DIHA 3123 A2A	TRBT
--	--	--	--	--------------	---------------	------

Eixo Dianteiro / Eje Delantero / Front Axle

Roda / Rueda / Wheel	•		20,000 lb.	3782 / 3720	807949	TRB
		•	20,000 lb.	HM 212049 / HM 212011		TRB
	•		13,200 lb.	3782 / 3720	807949	TRB
		•	13,200 lb.	HM 212047 / HM 212011	C4TA1215B	TRB
	•		13,200 lb.	HM 212049 / HM 212011		TRB

T800 * Aerocab * Modular * SHW (Short hood wide) * HB * BSH Aerocab * SH 6X4 * 8X4

Eixo Traseiro / Eje Trasero / Rear Axle

Diferencial - flecha de entrada / Diferencial - flecha de entrada / Differential - input shaft			Rockwell SSHD 46,000 lb.	JH 211749 / JH 211710	073 5370606	TRB
--	--	--	--------------------------	------------------------------	-------------	-----

	OUT	IN		Fersa [®]	Nº OEM	
---	-----	----	---	---------------------------	--------	---

KENWORTH

T800 * Aerocab * Modular * SHW (Short hood wide) * HB * BSH Aerocab * SH 6X4 * 8X4

Eixo Traseiro / Eje Trasero / Rear Axle

Diferencial - flecha de saída / Diferencial - flecha de salida / Differential - output shaft			Rockwell SSHD 46,000 lb.	LM 104949 / LM 104910		TRB
Diferencial - interdiferencial / Diferencial - interdiferencial / Differential - interdifferential			Rockwell SSHD 46,000 lb.	JLM 714149 / JLM 714110	735370574	TRB
Diferencial - (dir./esq.) / Diferencial - (der./izq.) / Differential (right/left)			Rockwell SSHD 46,000	47890 / 47820		TRB
Diferencial - nariz pinhão / Diferencial - nariz piñón / Differential - pinion			Rockwell SSHD 46,000 lb.	F 19034		CRBS
Diferencial - pinhão cabeça / Diferencial - piñón cabeça / Differential - pinion head			Rockwell SSHD 46,000 lb.	H 715343 / H 715311	500588901	TRB
Diferencial - pinhão cola / Diferencial - piñón cola / Differential - pinion rear			Rockwell SSHD 46,000 lb.	H 715334 / H 715311	500587901	TRB
			Rockwell SSHD 46,000 lb.	65237 / 65500	8Q4625A	TRB
Roda / Rueda / Wheel	•		40,000 lb.	580 / 572		TRB
		•	40,000 lb.	594 A / 592 A	183704	TRB

Direção / Dirección / Steering

Perno de direção / Perno de dirección / Pintle direction				T 182	DIHA 3123 A2A	TRBT
--	--	--	--	--------------	---------------	------

Eixo Dianteiro / Eje Delantero / Front Axle

Roda / Rueda / Wheel	•		Meritor FG-941, 13,200 lb. 90...03	3782 / 3720	807949	TRB
		•	Meritor FG-941, 13,200 lb. 90...03	HM 212049 / HM 212011		TRB
	•		Meritor FG-941, 13,200 lb. de 90...91	3782 / 3720	807949	TRB
		•	Meritor FG-941	HM 212047 / HM 212011	C4TA1215B	TRB
	•		Rockwell FL-941, 20,000 lb.	555 S / 552 A		TRB
		•	Rockwell FL-941, 20,000 lb.	6461A / 6420		TRB

W900 * W924

Eixo Traseiro / Eje Trasero / Rear Axle

Diferencial - flecha de entrada / Diferencial - flecha de entrada / Differential - input shaft			Rockwell SSHD 46,000 lb.	JH 211749 / JH 211710	073 5370606	TRB
Diferencial - flecha de saída / Diferencial - flecha de salida / Differential - output shaft			Rockwell SSHD 46,000 lb.	LM 104949 / LM 104910		TRB
Diferencial - interdiferencial / Diferencial - interdiferencial / Differential - interdifferential			Rockwell SSHD 46,000 lb.	JLM 714149 / JLM 714110	735370574	TRB
Diferencial - (dir./esq.) / Diferencial - (der./izq.) / Differential (right/left)			Rockwell SSHD 46,000	47890 / 47820		TRB
Diferencial - nariz pinhão / Diferencial - nariz piñón / Differential - pinion			Rockwell SSHD 46,000 lb.	F 19034		CRBS
Diferencial - pinhão cabeça / Diferencial - piñón cabeça / Differential - pinion head			Rockwell SSHD 46,000 lb.	H 715343 / H 715311	500588901	TRB
Diferencial - pinhão cola / Diferencial - piñón cola / Differential - pinion rear			Rockwell SSHD 46,000 lb.	65237 / 65500	8Q4625A	TRB
			Rockwell SSHD 46,000 lb.	H 715334 / H 715311	500587901	TRB
Roda / Rueda / Wheel	•		40,000 lb.	580 / 572		TRB
		•	40,000 lb.	594 A / 592 A	183704	TRB

Direção / Dirección / Steering

Perno de direção / Perno de dirección / Pintle direction				T 182	DIHA 3123 A2A	TRBT
--	--	--	--	--------------	---------------	------

	OUT	IN		Fersa®	N° OEM	
---	-----	----	---	---------------	--------	---

MERCEDES BENZ (NA)

L1113 * L1114 * L1116 * L1117 * L1118

Caixa de Mudanças / Caja de Cambios / Gearbox

			Tremec CL559	M 804049 / M 804010		TRB
			Tremec CL559	25590 / 25520		TRB

Eixo Traseiro / Eje Trasero / Rear Axle

Diferencial - eixo (traseiro) / Diferencial - eje (trasero) / Differential - shaft (rear)				31312 F	174716	TRB
				32020 XF	001 981 64 05	TRB

Eixo Dianteiro / Eje Delantero / Front Axle

Roda / Rueda / Wheel	•			3782 / 3720	B5QM1216A/9N4222	TRB
		•		HM 212049 / HM 212011		TRB

Eixo Traseiro / Eje Trasero / Rear Axle

Roda / Rueda / Wheel	•			39590 / 39520	2986843	TRB
	•			47686 / 47620	7EQH1238	TRB

L1214 * L1215 * L1217 39 * L1217 52 * L1218 52

Caixa de Mudanças / Caja de Cambios / Gearbox

				32208 F	LA5113	TRB
				32210 F	LA5115	TRB
			Fuller FS 6305 A	25590 / 25522	B7T1201A/ E7HZ7K228A	TRB
			Fuller FS 6305 A No. Fuller 658981 / 660181	3782 / 3720	B5QM1216A/9N4222	TRB
			Fuller FS 6305 A No. Fuller 675250 / 742259	39590 / 39520	2986843	TRB
			Fuller FS 6305 A	31594 / 31520	477080	TRB

Eixo Traseiro / Eje Trasero / Rear Axle

Diferencial / Diferencial / Differential				33020 F	005 981 84 05	TRB
Diferencial - eixo (traseiro) / Diferencial - eje (trasero) / Differential - shaft (rear)				32018 XF	004 981 43 05	TRB
				32020 XF	001 981 64 05	TRB
				F 15082	001 981 99 05	STRB
				F 15159	006 981 35 05	STRB
Diferencial (dir.) / Diferencial (der.) / Differential (right)			Eaton RS-17-220	497 / 493	7451380	TRB
Diferencial - (esq.) / Diferencial - (izq.) / Differential (left)			Eaton RS-17-220	56425 / 56650		TRB
Diferencial - pinhão cabeça / Diferencial - piñón cabeça / Differential - pinion head			Eaton RS-17-220	72200 C / 72487		TRB
Diferencial - pinhão (cabeza - cola) / Diferencial - piñón (cabeza/cola) / Differential - pinion head (rear)			Eaton RS-17-220	55200 C / 55437		TRB

Eixo Dianteiro / Eje Delantero / Front Axle

Roda / Rueda / Wheel	•			3782 / 3720	B5QM1216A/9N4222	TRB
		•		HM 212049 / HM 212011		TRB

Eixo Traseiro / Eje Trasero / Rear Axle

Roda / Rueda / Wheel	•			39590 / 39520	2986843	TRB
	•			47686 / 47620	7EQH1238	TRB

L1313 * L1314 * L1315 * L1316 * L1317 * L1318 * L1319 * L1321

Caixa de Mudanças / Caja de Cambios / Gearbox

			Tremec CL559 No. Fuller 235417 / 235418	M 804049 / M 804010		TRB
			Tremec CL559	25590 / 25520		TRB

	OUT	IN		Fersa®	Nº OEM	
---	-----	----	---	---------------	--------	---

MERCEDES BENZ (NA)

L1313 * L1314 * L1315 * L1316 * L1317 * L1318 * L1319 * L1321

Eixo Traseiro / Eje Trasero / Rear Axle

Diferencial - pinhão eixo (dianteiro/traseiro) / Diferencial - piñón eje (delantero/trasero) / Differential - shaft pinion (front/rear)				F 15158	012 981 85 05	STRB
---	--	--	--	----------------	---------------	------

Eixo Dianteiro / Eje Delantero / Front Axle

Roda / Rueda / Wheel	•			3782 / 3720	B5QM1216A/9N4222	TRB
		•		HM 212049 / HM 212011		TRB

Eixo Traseiro / Eje Trasero / Rear Axle

Roda / Rueda / Wheel	•			39590 / 39520	2986843	TRB
	•			47686 / 47620	7EQH1238	TRB

L1414 * L1416

Caixa de Mudanças / Caja de Cambios / Gearbox

				32208 F	LA5113	TRB
--	--	--	--	----------------	--------	-----

Eixo Traseiro / Eje Trasero / Rear Axle

Diferencial - eixo (traseiro) / Diferencial - eje (trasero) / Differential - shaft (rear)				32017 XF	184623	TRB
				32018 XF	004 981 43 05	TRB
				32020 XF	001 981 64 05	TRB
				F 15082	001 981 99 05	STRB

L1417 52

Caixa de Mudanças / Caja de Cambios / Gearbox

			Tremec FS 5005 No. Fuller 235417 / 235418	M 804049 / M 804010		TRB
			Tremec FS 5005	25590 / 25520		TRB
			Tremec FSM 5005 No. Fuller 235417 / 235418	M 804049 / M 804010		TRB
			Tremec FSM 5005 No. Fuller 654166 / 791943	25590 / 25520		TRB

Eixo Traseiro / Eje Trasero / Rear Axle

Diferencial (dir.) / Diferencial (der.) / Differential (right)				497 / 493	7451380	TRB
Diferencial - (esq.) / Diferencial - (izq.) / Differential (left)				56425 / 56650		TRB
Diferencial - pinhão cabeça / Diferencial - piñón cabeza / Differential - pinion head				72200 C / 72487		TRB
Diferencial - pinhão cola / Diferencial - piñón cola / Differential - pinion rear				55200 C / 55437		TRB

Eixo Dianteiro / Eje Delantero / Front Axle

Roda / Rueda / Wheel	•			3782 / 3720	B5QM1216A/9N4222	TRB
		•		HM 212049 / HM 212011		TRB

Eixo Traseiro / Eje Trasero / Rear Axle

Roda / Rueda / Wheel	•			580 / 572	600704011	TRB
		•		594 A / 592 A	183704	TRB

L1418 39 * L1418 52 * L1418 60 * L1418 59 * L1420 * L1422

Caixa de Mudanças / Caja de Cambios / Gearbox

				32208 F	LA5113	TRB
				3382 / 3320	050 139 82 17	TRB

Eixo Traseiro / Eje Trasero / Rear Axle

Diferencial - eixo (traseiro) / Diferencial - eje (trasero) / Differential - shaft (rear)				32017 XF	184623	TRB
--	--	--	--	-----------------	--------	-----

	OUT	IN		Fersa®	N° OEM	
---	-----	----	---	---------------	--------	---

MERCEDES BENZ (NA)

L1418 39 * L1418 52 * L1418 60 * L1419 59 * L1420 * L1422

Eixo Traseiro / Eje Trasero / Rear Axle

Diferencial - eixo (traseiro) / Diferencial - eje (trasero) / Differential - rear shaft				32018 XF	004 981 43 05	TRB
				32020 XF	001 981 64 05	TRB
				F 15082	001 981 99 05	STRB
Diferencial (dir.) / Diferencial (der.) / Differential (right)			Eaton 19055T	497 / 493	7451380	TRB
Diferencial - (esq.) / Diferencial - (izq.) / Differential (left)			Eaton 19055T	56425 / 56650		TRB
Diferencial - pinhão cabeça / Diferencial - piñón cabeça / Differential - pinion head				72200 C / 72487		TRB
Diferencial - pinhão cola / Diferencial - piñón cola / Differential - pinion rear			Eaton 19055T	55200 C / 55437		TRB

Eixo Dianteiro / Eje Delantero / Front Axle

Roda / Rueda / Wheel	•			3782 / 3720	B5QM1216A/9N4222	TRB
		•		HM 212049 / HM 212011		TRB

L1518 52

Caixa de Mudanças / Caja de Cambios / Gearbox

			Tremec FS 5005 No. Fuller 235417 / 235418	M 804049 / M 804010		TRB
			Tremec FS 5005	M 804049 / M 804010		TRB
			Tremec FS 5005 No. Fuller 654166 / 791943	25590 / 25520		TRB
			Tremec FSM 5005	M 804049 / M 804010		TRB
			Tremec FSM 5005 No. Fuller 654166 / 791943	25590 / 25520		TRB

Eixo Traseiro / Eje Trasero / Rear Axle

Diferencial (dir.) / Diferencial (der.) / Differential (right)				497 / 493	7451380	TRB
Diferencial - (esq.) / Diferencial - (izq.) / Differential (left)				56425 / 56650		TRB
Diferencial - pinhão cabeça / Diferencial - piñón cabeça / Differential - pinion head				72200 C / 72487		TRB
Diferencial - pinhão cola / Diferencial - piñón cola / Differential - pinion rear				55200 C / 55437		TRB

Eixo Dianteiro / Eje Delantero / Front Axle

Roda / Rueda / Wheel	•			3782 / 3720	B5QM1216A/9N4222	TRB
		•		HM 212049 / HM 212011		TRB

Eixo Traseiro / Eje Trasero / Rear Axle

Roda / Rueda / Wheel	•			580 / 572	600704011	TRB
		•		594 A / 592 A	183704	TRB
	•		44,000 lb.	39590 / 39520	2986843	TRB
		•	44,000 lb.	47686 / 47620	7EQH1238	TRB

L1617 59

Caixa de Transferência / Caja de Transferencia / Transfer Case

				33210 F	003 981 83 05	TRB
--	--	--	--	----------------	---------------	-----

Caixa de Mudanças / Caja de Cambios / Gearbox

			Tremec FS 5005	M 804049 / M 804010		TRB
			Tremec FS 5005 No. Fuller 654166 / 791943	25590 / 25520		TRB

	OUT	IN		Fersa®	Nº OEM	
---	-----	----	---	---------------	--------	---

MERCEDES BENZ (NA)

L1617 59

Caixa de Mudanças / Caja de Cambios / Gearbox

			Tremec FSM 5005 No. Fuller 235417 / 235418	M 804049 / M 804010		TRB
			Tremec FSM 5005 No. Fuller 654166 / 791943	25590 / 25520		TRB

Eixo Traseiro / Eje Trasero / Rear Axle

Diferencial / Diferencial / Differential				32314 BF	003 981 31 05	TRB
Diferencial - eixo (traseiro) / Diferencial - eje (trasero) / Differential - shaft (rear)				32017 XF	184623	TRB
				32018 XF	004 981 43 05	TRB
				32020 XF	001 981 64 05	TRB
				F 15082	001 981 99 05	STRB
				F 15159	006 981 35 05	STRB
Diferencial (dir.) / Diferencial (der.) / Differential (right)				497 / 493	7451380	TRB
Diferencial - (esq.) / Diferencial - (izq.) / Differential (left)				56425 / 56650		TRB
Diferencial - pinhão cabeça / Diferencial - piñón cabeça / Differential - pinion head				72200 C / 72487		TRB
Diferencial - pinhão cola / Diferencial - piñón cola / Differential - pinion rear				55200 C / 55437		TRB

Eixo Dianteiro / Eje Delantero / Front Axle

Roda / Rueda / Wheel	•			3782 / 3720	B5QM1216A/9N4222	TRB
		•		HM 212049 / HM 212011		TRB

Eixo Traseiro / Eje Trasero / Rear Axle

Roda / Rueda / Wheel	•			580 / 572	600704011	TRB
		•		594 A / 592 A	183704	TRB

L1618

Caixa de Transferência / Caja de Transferencia / Transfer Case

				33210 F	003 981 83 05	TRB
--	--	--	--	----------------	---------------	-----

Eixo Traseiro / Eje Trasero / Rear Axle

Diferencial / Diferencial / Differential				33115 F	003 981 30 05	TRB
				32314 BF	003 981 31 05	TRB
Diferencial - eixo (traseiro) / Diferencial - eje (trasero) / Differential - shaft (rear)				32017 XF	184623	TRB
				32018 XF	004 981 43 05	TRB
				32020 XF	001 981 64 05	TRB
				F 15082	001 981 99 05	STRB
				F 15159	006 981 35 05	STRB

Eixo Dianteiro / Eje Delantero / Front Axle

Roda / Rueda / Wheel		•		F 15051 C	005 981 30 05	STRB
	•			32310 F	001 981 74 05	TRB

L1619 52

Eixo Traseiro / Eje Trasero / Rear Axle

Diferencial (dir.) / Diferencial (der.) / Differential (right)				497 / 493	7451380	TRB
Diferencial - (esq.) / Diferencial - (izq.) / Differential (left)				56425 / 56650		TRB
Diferencial - pinhão cabeça / Diferencial - piñón cabeça / Differential - pinion head				72200 C / 72487		TRB
Diferencial - pinhão cola / Diferencial - piñón cola / Differential - pinion rear				55200 C / 55437		TRB

	OUT	IN		Fersa®	N° OEM	
---	-----	----	---	---------------	--------	---

MERCEDES BENZ (NA)

L1619 52

Eixo Dianteiro / Eje Delantero / Front Axle

Roda / Rueda / Wheel	•			3782 / 3720	B5QM1216A/9N4222	TRB
		•		HM 212049 / HM 212011		TRB

Eixo Traseiro / Eje Trasero / Rear Axle

Roda / Rueda / Wheel	•			580 / 572	600704011	TRB
		•		594 A / 592 A	183704	TRB

L1621 54 * L1621 59 * L1621 60 * L1621 70 * L1622 * L1623 * L1625

Caixa de Transferência / Caja de Transferencia / Transfer Case

				33210 F	003 981 83 05	TRB
--	--	--	--	----------------	---------------	-----

Eixo Traseiro / Eje Trasero / Rear Axle

Diferencial / Diferencial / Differential				33115 F	003 981 30 05	TRB
Diferencial - eixo (traseiro) / Diferencial - eje (trasero) / Differential - shaft (rear)				32017 XF	184623	TRB
				32018 XF	004 981 43 05	TRB
				32020 XF	001 981 64 05	TRB
				F 15082	001 981 99 05	STRB
				F 15159	006 981 35 05	STRB

Eixo Dianteiro / Eje Delantero / Front Axle

Roda / Rueda / Wheel	•			32310 F	001 981 74 05	TRB
		•		F 15051 C	005 981 30 05	STRB

L1621 52

Eixo Traseiro / Eje Trasero / Rear Axle

Diferencial (dir.) / Diferencial (der.) / Differential (right)				497 / 493	7451380	TRB
Diferencial - (esq.) / Diferencial - (izq.) / Differential (left)				56425 / 56650		TRB
Diferencial - pinhão cabeça / Diferencial - piñón cabeza / Differential - pinion head				72200 C / 72487		TRB
Diferencial - pinhão cola / Diferencial - piñón cola / Differential - pinion rear				55200 C / 55437		TRB

Eixo Dianteiro / Eje Delantero / Front Axle

Roda / Rueda / Wheel	•			3782 / 3720	B5QM1216A/9N4222	TRB
		•		HM 212049 / HM 212011		TRB

Eixo Traseiro / Eje Trasero / Rear Axle

Roda / Rueda / Wheel	•			580 / 572	600704011	TRB
		•		594 A / 592 A	183704	TRB

L1630 * L1632 * L1633 * L1634

Caixa de Transferência / Caja de Transferencia / Transfer Case

				33210 F	003 981 83 05	TRB
--	--	--	--	----------------	---------------	-----

Eixo Traseiro / Eje Trasero / Rear Axle

Diferencial / Diferencial / Differential				32314 BF	003 981 31 05	TRB
Diferencial - eixo (traseiro) / Diferencial - eje (trasero) / Differential - shaft (rear)				32017 XF	184623	TRB
				32018 XF	004 981 43 05	TRB
				32020 XF	001 981 64 05	TRB
				F 15082	001 981 99 05	STRB
				F 15159	006 981 35 05	STRB



MERCEDES BENZ (NA)

L1630 * L1632 * L1633 * L1634

Eixo Dianteiro / Eje Delantero / Front Axle

Roda / Rueda / Wheel	•			32310 F	001 981 74 05	TRB
		•		F 15051 C	005 981 30 05	STRB

L1924 * L1929 * L1930 * L1932 * L1933 * L1934 * L1935 * L1937 * L1938 * L1939 * L1941 * L1942 * L1944 * L1945 * L1951

Caixa de Mudanças / Caja de Cambios / Gearbox

			ZF 105	F 15047	073 537 00 55	STRB
			ZF 105	NUP 314 FMNR / C3	001 981 98 02	CRB
			ZF 105	32309 F	004 981 13 05	TRB

Eixo Traseiro / Eje Trasero / Rear Axle

Diferencial - eixo (traseiro) / Diferencial - eje (trasero) / Differential - shaft (rear)				32020 XF	001 981 64 05	TRB
---	--	--	--	-----------------	---------------	-----

Eixo Dianteiro / Eje Delantero / Front Axle

Roda / Rueda / Wheel				F 15051 C	005 981 30 05	STRB
----------------------	--	--	--	------------------	---------------	------

L2013 * L2014 * L2016 * L2017 * L2024 * L2036 * L2042

Eixo Traseiro / Eje Trasero / Rear Axle

Diferencial - eixo (traseiro) / Diferencial - eje (trasero) / Differential - shaft (rear)				32018 XF	004 981 43 05	TRB
Diferencial - eixo (traseiro) / Diferencial - eje (trasero) / Differential - shaft (rear)				F 15159	006 981 35 05	STRB

Eixo Dianteiro / Eje Delantero / Front Axle

Roda / Rueda / Wheel				F 15051 C	005 981 30 05	STRB
----------------------	--	--	--	------------------	---------------	------

L2121 54

Caixa de Mudanças / Caja de Cambios / Gearbox

			Tremec CL559 No. Fuller 235417 / 235418	M 804049 / M 804010		TRB
			Tremec CL559 No. Fuller 654166 / 791943	25590 / 25520		TRB

Eixo Traseiro / Eje Trasero / Rear Axle

Diferencial (dir.) / Diferencial (der.) / Differential (right)				497 / 493	7451380	TRB
Diferencial - (esq.) / Diferencial - (izq.) / Differential (left)				56425 / 56650		TRB
Diferencial - pinhão cabeça / Diferencial - piñón cabeza / Differential - pinion head				72200 C / 72487		TRB
Diferencial - pinhão cola / Diferencial - piñón cola / Differential - pinion (rear)				55200 C / 55437		TRB

Eixo Dianteiro / Eje Delantero / Front Axle

Roda / Rueda / Wheel	•			3782 / 3720	B5QM1216A/9N4222	TRB
		•		HM 212049 / HM 212011		TRB

Eixo Traseiro / Eje Trasero / Rear Axle

Roda / Rueda / Wheel	•			580 / 572	600704011	TRB
		•		594 A / 592 A	183704	TRB

L2221

Eixo Traseiro / Eje Trasero / Rear Axle

Diferencial (dir.) / Diferencial (der.) / Differential (right)				497 / 493	7451380	TRB
Diferencial - (esq.) / Diferencial - (izq.) / Differential (left)				56425 / 56650		TRB
Diferencial - pinhão cabeça / Diferencial - piñón cabeza / Differential - pinion head				72188 C / 72487		TRB

	OUT	IN		Fersa®	N° OEM	
---	-----	----	---	---------------	--------	---

MERCEDES BENZ (NA)

L2221

Eixo Traseiro / Eje Trasero / Rear Axle

Diferencial - pinhão cabeça / Diferencial - piñón cabeza / Differential - pinion head				72218 C / 72487		TRB
Diferencial - pinhão cola / Diferencial - piñón cola / Differential - pinion rear				HM 807049 / HM 807010		TRB

Eixo Dianteiro / Eje Delantero / Front Axle

Roda / Rueda / Wheel	•			3782 / 3720	B5QM1216A/9N4222	TRB
		•		HM 212049 / HM 212011		TRB

Eixo Traseiro / Eje Trasero / Rear Axle

Roda / Rueda / Wheel	•			580 / 572	600704011	TRB
		•		594 A / 592 A	183704	TRB

LK1417 34

Caixa de Mudanças / Caja de Cambios / Gearbox

			Tremec FS 5005 No. Fuller 235417 / 235418	M 804049 / M 804010		TRB
			Tremec FS 5005 No. Fuller 654166 / 791943	25590 / 25520		TRB
			Tremec FSM 5005 No. Fuller 235417 / 235418	M 804049 / M 804010		TRB
			Tremec FSM 5005 No. Fuller 654166 / 791943	25590 / 25520		TRB

Eixo Traseiro / Eje Trasero / Rear Axle

Diferencial (dir.) / Diferencial (der.) / Differential (right)				497 / 493	7451380	TRB
Diferencial - (esq.) / Diferencial - (izq.) / Differential (left)				56425 / 56650		TRB
Diferencial - pinhão cabeça / Diferencial - piñón cabeza / Differential - pinion head				72200 C / 72487		TRB
Diferencial - pinhão cola / Diferencial - piñón cola / Differential - pinion rear				55200 C / 55437		TRB

Eixo Dianteiro / Eje Delantero / Front Axle

Roda / Rueda / Wheel	•			3782 / 3720	B5QM1216A/9N4222	TRB
		•		HM 212049 / HM 212011		TRB

Eixo Traseiro / Eje Trasero / Rear Axle

Roda / Rueda / Wheel	•			39590 / 39520	2986843	TRB
		•		47686 / 47620	7EQH1238	TRB

LK1418 39 * LK1418 52

Caixa de Mudanças / Caja de Cambios / Gearbox

				32208 F	LA5113	TRB
			Tremec FS 5005	M 804049 / M 804010		TRB
			Tremec FS 5005 No. Fuller 654166 / 791943	25590 / 25520		TRB
			Tremec FSM 5005 No. Fuller 235417 / 235418	M 804049 / M 804010		TRB
			Tremec FSM 5005 No. Fuller 654166 / 791943	25590 / 25520		TRB

Eixo Traseiro / Eje Trasero / Rear Axle

Diferencial - eixo (traseiro) / Diferencial - eje (trasero) / Differential - shaft (rear)				32017 XF	184623	TRB
				32018 XF	004 981 43 05	TRB
				32020 XF	001 981 64 05	TRB
				F 15082	001 981 99 05	STRB

	OUT	IN		Fersa®	Nº OEM	
---	-----	----	---	---------------	--------	---

MERCEDES BENZ (NA)

LK1418 39 * LK1418 52

Eixo Dianteiro / Eje Delantero / Front Axle

Roda / Rueda / Wheel	•			3782 / 3720	B5QM1216A/9N4222	TRB
		•		HM 212049 / HM 212011		TRB

LK1420 * LK1422

Caixa de Mudanças / Caja de Cambios / Gearbox

				32208 F	LA5113	TRB
--	--	--	--	----------------	--------	-----

Eixo Traseiro / Eje Trasero / Rear Axle

Diferencial - eixo (traseiro) / Diferencial - eje (trasero) / Differential - shaft (rear)				32017 XF	184623	TRB
				32018 XF	004 981 43 05	TRB
				32020 XF	001 981 64 05	TRB
				F 15082	001 981 99 05	STRB

Eixo Dianteiro / Eje Delantero / Front Axle

Roda / Rueda / Wheel				559 / 552 A	3449817005	TRB
----------------------	--	--	--	--------------------	------------	-----

MBO 1017

Eixo Traseiro / Eje Trasero / Rear Axle

Diferencial (dir.) / Diferencial (der.) / Differential (right)				JLM 714149 / JLM 714110	3459817118	TRB
Diferencial - pinhão cabeça / Diferencial - piñón cabeza / Differential - pinion head				55200 C / 55437		TRB
Diferencial - pinhão cola / Diferencial - piñón cola / Differential - pinion (rear)				M 804049 / M 804010		TRB

Eixo Dianteiro / Eje Delantero / Front Axle

Roda / Rueda / Wheel	•			25877 / 25820		TRB
		•		JM 207049 / JM 207010		TRB

Eixo Traseiro / Eje Trasero / Rear Axle

Roda / Rueda / Wheel	•			33287 / 33462		TRB
		•		3982 / 3920	94630960	TRB

MBO 1018 44

Caixa de Mudanças / Caja de Cambios / Gearbox

			Fuller FS 6305 A No. Fuller 1313645 / 791943	25590 / 25522	B7T1201A/ E7HZ7K228A	TRB
			Fuller FS 6305 A No. Fuller 658981 / 660181	3782 / 3720	B5QM1216A/9N4222	TRB
			Fuller FS 6305 A No. Fuller 675250 / 742259	39590 / 39520	2986843	TRB
			Fuller FS 6305 A	31594 / 31520	477080	TRB
			Tremec FS 5005	M 804049 / M 804010		TRB
			Tremec FS 5005 No. Fuller 654166 / 791943	25590 / 25520		TRB
			Tremec FSM 5005	M 804049 / M 804010		TRB
			Tremec FSM 5005 No. Fuller 654166 / 791943	25590 / 25520		TRB

Eixo Traseiro / Eje Trasero / Rear Axle

Diferencial (dir.) / Diferencial (der.) / Differential (right)				JLM 714149 / JLM 714110	3459817118	TRB
Diferencial - (esq.) / Diferencial - (izq.) / Differential (left)			Eaton RS-17-220	42381 / 42584	3315955	TRB

	OUT	IN		Fersa®	N° OEM	
---	-----	----	---	---------------	--------	---

MERCEDES BENZ (NA)

MBO 1018 44

Eixo Traseiro / Eje Trasero / Rear Axle

Diferencial - pinhão cabeça / Diferencial - piñón cabeza / Differential - pinion head			Eaton RS-17-220	M 804049 / M 804010		TRB
Diferencial - pinhão cola / Diferencial - piñón cola / Differential - pinion (rear)			Eaton RS-17-220	55200 C / 55437		TRB

Eixo Dianteiro / Eje Delantero / Front Axle

Roda / Rueda / Wheel	•			25877 / 25820		TRB
		•		JM 207049 A / JM 207010		TRB

Eixo Traseiro / Eje Trasero / Rear Axle

Roda / Rueda / Wheel	•			39590 / 39520	2986843	TRB
		•		47686 / 47620	7EQH1238	TRB

MBO 1019 44 Boxer

Caixa de Mudanças / Caja de Cambios / Gearbox

			Fuller FS 6305 A No. Fuller 1313645 / 791943	25590 / 25522	B7T1201A/ E7HZ7K228A	TRB
			Fuller FS 6305 A No. Fuller 658981 / 660181	3782 / 3720	B5QM1216A/9N4222	TRB
			Fuller FS 6305 A No. Fuller 675250 / 742259	39590 / 39520	2986843	TRB
			Fuller FS 6305 A	31594 / 31520	477080	TRB
			Tremec FS 5005 No. Fuller 235417 / 235418	M 804049 / M 804010		TRB
			Tremec FS 5005 No. Fuller 654166 / 791943	25590 / 25520		TRB
			Tremec FSM 5005 No. Fuller 235417 / 235418	M 804049 / M 804010		TRB
			Tremec FSM 5005 No. Fuller 654166 / 791943	25590 / 25520		TRB

Eixo Traseiro / Eje Trasero / Rear Axle

Diferencial (dir.) / Diferencial (der.) / Differential (right)				JLM 714149 / JLM 714110	3459817118	TRB
Diferencial - (esq.) / Diferencial - (izq.) / Differential (left)				42381 / 42584	3315955	TRB
Diferencial - pinhão cabeça / Diferencial - piñón cabeza / Differential - pinion head				M 804049 / M 804010		TRB
Diferencial - pinhão cola / Diferencial - piñón cola / Differential - pinion (rear)				55200 C / 55437		TRB

Eixo Dianteiro / Eje Delantero / Front Axle

Roda / Rueda / Wheel	•			25877 / 25820		TRB
		•		JM 207049 A / JM 207010		TRB

Eixo Traseiro / Eje Trasero / Rear Axle

Roda / Rueda / Wheel	•			39590 / 39520	2986843	TRB
		•		47686 / 47620	7EQH1238	TRB

MBO 1217

Eixo Traseiro / Eje Trasero / Rear Axle

Diferencial (dir.) / Diferencial (der.) / Differential (right)				497 / 493	7451380	TRB
Diferencial - (esq.) / Diferencial - (izq.) / Differential (left)				56425 / 56650		TRB
Diferencial - pinhão cabeça / Diferencial - piñón cabeza / Differential - pinion head				72200 C / 72487		TRB
Diferencial - pinhão cola / Diferencial - piñón cola / Differential - pinion (rear)				55200 C / 55437		TRB

	OUT	IN		Fersa®	Nº OEM	
---	-----	----	---	---------------	--------	---

MERCEDES BENZ (NA)

MBO 1217

Eixo Dianteiro / Eje Delantero / Front Axle

Roda / Rueda / Wheel	•			3782 / 3720	B5QM1216A/9N4222	TRB
		•		HM 212049 / HM 212011		TRB

Eixo Traseiro / Eje Trasero / Rear Axle

Roda / Rueda / Wheel	•			39590 / 39520	2986843	TRB
		•		47686 / 47620	7EQH1238	TRB

MBO 1219 52 Boxer

Caixa de Mudanças / Caja de Cambios / Gearbox

			Fuller FS5406	25590 / 25522	B7T1201A/ E7HZ7K228A	TRB
			Fuller FS5406	39590 / 39520	2986843	TRB
			Fuller FS5406	31594 / 31520	477080	TRB
			Fuller FS5406	3782 / 3720	B5QM1216A/9N4222	TRB
			Tremec FS 5005 No. Fuller 235417 / 235418	M 804049 / M 804010		TRB
			Tremec FS 5005 No. Fuller 654166 / 791943	25590 / 25520		TRB
			Tremec FSM 5005	M 804049 / M 804010		TRB
			Tremec FSM 5005 No. Fuller 654166 / 791943	25590 / 25520		TRB

Eixo Dianteiro / Eje Delantero / Front Axle

Roda / Rueda / Wheel	•			3782 / 3720	B5QM1216A/9N4222	TRB
		•		HM 212049 / HM 212011		TRB

Eixo Traseiro / Eje Trasero / Rear Axle

Roda / Rueda / Wheel	•			39590 / 39520	2986843	TRB
		•		47686 / 47620	7EQH1238	TRB

MBO 1417

Eixo Traseiro / Eje Trasero / Rear Axle

Diferencial (dir.) / Diferencial (der.) / Differential (right)				497 / 493	7451380	TRB
Diferencial - (esq.) / Diferencial - (izq.) / Differential (left)				56425 / 56650		TRB
Diferencial - pinhão cabeça / Diferencial - piñón cabeza / Differential - pinion head				72200 C / 72487		TRB
Diferencial - pinhão cola / Diferencial - piñón cola / Differential - pinion (rear)				55200 C / 55437		TRB

Eixo Dianteiro / Eje Delantero / Front Axle

Roda / Rueda / Wheel	•			3782 / 3720	B5QM1216A/9N4222	TRB
		•		HM 212049 / HM 212011		TRB

Eixo Traseiro / Eje Trasero / Rear Axle

Roda / Rueda / Wheel	•			39590 / 39520	2986843	TRB
		•		47686 / 47620	7EQH1238	TRB

MBO 1418 60

Caixa de Mudanças / Caja de Cambios / Gearbox

			Fuller FS5406	25590 / 25522	B7T1201A/ E7HZ7K228A	TRB
			Fuller FS5406	39590 / 39520	2986843	TRB
			Fuller FS5406	31594 / 31520	477080	TRB
			Fuller FS5406	3782 / 3720	B5QM1216A/9N4222	TRB

	OUT	IN		Fersa®	N° OEM	
---	-----	----	---	---------------	--------	---

MERCEDES BENZ (NA)

MBO 1418 60

Eixo Traseiro / Eje Trasero / Rear Axle

Diferencial - pinhão cabeça / Diferencial - piñón cabeza / Differential - pinion head			Eaton 19055T	72200 C / 72487		TRB
---	--	--	--------------	-----------------	--	-----

Eixo Dianteiro / Eje Delantero / Front Axle

Roda / Rueda / Wheel	•			3782 / 3720	B5QM1216A/9N4222	TRB
		•		HM 212049 / HM 212011		TRB

Eixo Traseiro / Eje Trasero / Rear Axle

Roda / Rueda / Wheel	•			39590 / 39520	2986843	TRB
		•		47686 / 47620	7EQH1238	TRB

MBO 1419 60 Boxer

Caixa de Mudanças / Caja de Cambios / Gearbox

			Fuller FS5406	25590 / 25522	B7T1201A/ E7HZ7K228A	TRB
			Fuller FS5406	39590 / 39520	2986843	TRB
			Fuller FS5406	31594 / 31520	477080	TRB
			Fuller FS5406	3782 / 3720	B5QM1216A/9N4222	TRB

Eixo Traseiro / Eje Trasero / Rear Axle

Diferencial (dir.) / Diferencial (der.) / Differential (right)				497 / 493	7451380	TRB
Diferencial - (esq.) / Diferencial - (izq.) / Differential (left)				56425 / 56650		TRB
Diferencial - pinhão cabeça / Diferencial - piñón cabeza / Differential - pinion head				72200 C / 72487		TRB
Diferencial - pinhão cola / Diferencial - piñón cola / Differential - pinion (rear)				55200 C / 55437		TRB

Eixo Dianteiro / Eje Delantero / Front Axle

Roda / Rueda / Wheel	•			3782 / 3720	B5QM1216A/9N4222	TRB
		•		HM 212049 / HM 212011		TRB

MBO 1621

Eixo Traseiro / Eje Trasero / Rear Axle

Diferencial (dir.) / Diferencial (der.) / Differential (right)				497 / 493	7451380	TRB
Diferencial - (esq.) / Diferencial - (izq.) / Differential (left)				56425 / 56650		TRB
Diferencial - pinhão cabeça / Diferencial - piñón cabeza / Differential - pinion head				72200 C / 72487		TRB
Diferencial - pinhão cola / Diferencial - piñón cola / Differential - pinion (rear)				55200 C / 55437		TRB

Eixo Dianteiro / Eje Delantero / Front Axle

Roda / Rueda / Wheel	•			3782 / 3720	B5QM1216A/9N4222	TRB
		•		HM 212049 / HM 212011		TRB

Eixo Traseiro / Eje Trasero / Rear Axle

Roda / Rueda / Wheel	•			580 / 572	600704011	TRB
		•		594 A / 592 A	183704	TRB

OF 1313 * OF 1314 * OF 1315 * OF 1316 * OF 1317 * OF 1318 51

Eixo Traseiro / Eje Trasero / Rear Axle

Diferencial - eixo (traseiro) / Diferencial - eje (trasero) / Differential - shaft (rear)				32018 XF	004 981 43 05	TRB
				32020 XF	001 981 64 05	TRB
				F 15082	001 981 99 05	STRB



MERCEDES BENZ (NA)

OF 1313 * OF 1314 * OF 1315 * OF 1316 * OF 1317 * OF 1318 51

Eixo Traseiro / Eje Trasero / Rear Axle

Diferencial - eixo (traseiro) / Diferencial - eje (trasero) / Differential - rear shaft			F 15159	006 981 35 05	STRB
Diferencial (dir.) / Diferencial (der.) / Differential (right)			497 / 493	7451380	TRB
Diferencial - (esq.) / Diferencial - (izq.) / Differential (left)			598 A / 592 A		TRB
Diferencial - pinhão (cabeza - cola) / Diferencial - piñón (cabeza / cola) / Differential - pinion head (rear)			55200 C / 55437		TRB
Diferencial - pinhão eixo (dianteiro/traseiro) / Diferencial - piñón eje (delantero/trasero) / Differential - shaft pinion (front/rear)			F 15158	012 981 85 05	STRB

Eixo Dianteiro / Eje Delantero / Front Axle

Roda / Rueda / Wheel	•		3782 / 3720	B5QM1216A/9N4222	TRB
		•	HM 212049 / HM 212011		TRB

Eixo Traseiro / Eje Trasero / Rear Axle

Roda / Rueda / Wheel	•		39590 / 39520	2986843	TRB
		•	47686 / 47620	7EQH1238	TRB

OMC 1418 51 * OMC 1418 60

Eixo Traseiro / Eje Trasero / Rear Axle

Diferencial (dir.) / Diferencial (der.) / Differential (right)			497 / 493	7451380	TRB
Diferencial - (esq.) / Diferencial - (izq.) / Differential (left)			598 A / 592 A		TRB
Diferencial - pinhão cabeça / Diferencial - piñón cabeça / Differential - pinion head			72200 C / 72487		TRB
Diferencial - pinhão cola / Diferencial - piñón cola / Differential - pinion (rear)			55200 C / 55437		TRB

Eixo Dianteiro / Eje Delantero / Front Axle

Roda / Rueda / Wheel	•		3782 / 3720	B5QM1216A/9N4222	TRB
		•	HM 212049 / HM 212011		TRB

Eixo Traseiro / Eje Trasero / Rear Axle

Roda / Rueda / Wheel	•		47686 / 47620	7EQH1238	TRB
		•	39590 / 39520	2986843	TRB

OMC 1419 51

Caixa de Mudanças / Caja de Cambios / Gearbox

		Fuller FS5406	25590 / 25522	B7T1201A/ E7HZ7K228A	TRB
		Fuller FS5406	39590 / 39520	2986843	TRB
		Fuller FS5406 No. Fuller 710787	31594 / 31520	477080	TRB
		Fuller FS5406	3782 / 3720	B5QM1216A/9N4222	TRB
		Tremec FS 5005 No. Fuller 235417 / 235418	M 804049 / M 804010		TRB
		Tremec FS 5005 No. Fuller 654166 / 791943	25590 / 25520		TRB
		Tremec FSM 5005 No. Fuller 235417 / 235418	M 804049 / M 804010		TRB
		Tremec FSM 5005 No. Fuller 654166 / 791943	25590 / 25520		TRB

Eixo Dianteiro / Eje Delantero / Front Axle

Roda / Rueda / Wheel	•		3782 / 3720	B5QM1216A/9N4222	TRB
		•	HM 212049 / HM 212011		TRB

	OUT	IN		Fersa®	Nº OEM	
---	-----	----	---	---------------	--------	---

MERCEDES BENZ (NA)

OMC 1419 51

Eixo Traseiro / Eje Trasero / Rear Axle

Roda / Rueda / Wheel	•			39590 / 39520	2986843	TRB
		•		47686 / 47620	7EQH1238	TRB

OMC 1423 51 Torino

Caixa de Mudanças / Caja de Cambios / Gearbox

			Fuller FS 6406 A No. Fuller 711123 / 5202047	45284 / 45220		TRB
			Fuller FS 6406 A No. Fuller 1313645 / 791943	25590 / 25522	B7T1201A/ E7HZ7K228A	TRB
			Fuller FS 6406 A No. Fuller 658981 / 660181	3782 / 3720	B5QM1216A/9N4222	TRB
			Fuller FS 6406 A No. Fuller 675250 / 742259	39590 / 39520	2986843	TRB
			Fuller FS 6406 A	31594 / 31520	477080	TRB

Eixo Traseiro / Eje Trasero / Rear Axle

Diferencial - eixo (traseiro) / Diferencial - eje (trasero) / Differential - shaft (rear)				F 19015	3459817501	CRBS
Diferencial (dir.) / Diferencial (der.) / Differential (right)				497 / 493	7451380	TRB
Diferencial - (esq.) / Diferencial - (izq.) / Differential (left)				598 A / 592 A		TRB
Diferencial - pinhão cabeça / Diferencial - piñón cabeza / Differential - pinion head				72200 C / 72487		TRB
Diferencial - pinhão cola / Diferencial - piñón cola / Differential - pinion (rear)				55200 C / 55437		TRB

OMC 1421 51

Eixo Dianteiro / Eje Delantero / Front Axle

Roda / Rueda / Wheel	•			3782 / 3720	B5QM1216A/9N4222	TRB
		•		HM 212049 / HM 212011		TRB

Eixo Traseiro / Eje Trasero / Rear Axle

Roda / Rueda / Wheel	•			580 / 572	600704011	TRB
		•		594 A / 592 A	183704	TRB

OMC 1425 51 Allegro

Caixa de Mudanças / Caja de Cambios / Gearbox

			Fuller FS 8406 A No. Fuller 1313645 / 791943	25590 / 25522	B7T1201A/ E7HZ7K228A	TRB
			Fuller FS 8406 A No. Fuller 658981 / 660181	3782 / 3720	B5QM1216A/9N4222	TRB
			Fuller FS 8406 A No. Fuller 675250 / 742259	39590 / 39520	2986843	TRB
			Fuller FS 8406 A	31594 / 31520	477080	TRB

Eixo Traseiro / Eje Trasero / Rear Axle

Diferencial - eixo (traseiro) / Diferencial - eje (trasero) / Differential - shaft (rear)				F 19015	3459817501	CRBS
Diferencial (dir.) / Diferencial (der.) / Differential (right)			Eaton 23080S	497 / 493	7451380	TRB
Diferencial - (esq.) / Diferencial - (izq.) / Differential (left)			Eaton 23080S	598 A / 592 A		TRB
Diferencial - pinhão cabeça / Diferencial - piñón cabeza / Differential - pinion head			Eaton 23080S	H 914841 / H 914811		TRB
Diferencial - pinhão cola / Diferencial - piñón cola / Differential - pinion (rear)			Eaton 23080S	HM 813841 / HM 813810		TRB

	OUT	IN		Fersa®	N° OEM	
---	-----	----	---	---------------	--------	---

MERCEDES BENZ (CA)

L 1312

Caixa de Mudanças / Caja de Cambios / Gearbox

				30306 F	001 981 57 05	TRB
--	--	--	--	----------------	---------------	-----

Eixo Traseiro / Eje Trasero / Rear Axle

Diferencial - eixo (traseiro) / Diferencial - eje (trasero) / Differential - shaft (rear)				32212 F	3129810101	TRB
Roda / Rueda / Wheel				32214 F	3129810001	TRB

Eixo Dianteiro / Eje Delantero / Front Axle

Roda / Rueda / Wheel				30312 F	001 981 97 05	TRB
				32306 F	3129810205	TRB

L 1524 * L 1525

Eixo Traseiro / Eje Trasero / Rear Axle

Diferencial / Diferencial / Differential				F 15083	003 981 19 05	STRB
				33115 F	003 981 30 05	TRB
Diferencial - eixo (traseiro) / Diferencial - eje (trasero) / Differential - shaft (rear)				32017 XF	184623	TRB
				32018 XF	004 981 43 05	TRB
				32020 XF	001 981 64 05	TRB
				F 15082	001 981 99 05	STRB
				F 15159	006 981 35 05	STRB
Roda / Rueda / Wheel		•		32218 F	072 003 22 18	TRB

L 1614 * L 1615

Caixa de Transferência / Caja de Transferencia / Transfer Case

				33210 F	003 981 83 05	TRB
--	--	--	--	----------------	---------------	-----

Eixo Traseiro / Eje Trasero / Rear Axle

Diferencial / Diferencial / Differential				F 15083	003 981 19 05	STRB
				32314 BF	003 981 31 05	TRB
Diferencial - eixo (traseiro) / Diferencial - eje (trasero) / Differential - shaft (rear)				32017 XF	184623	TRB
				32018 XF	004 981 43 05	TRB
				32020 XF	001 981 64 05	TRB
				F 15082	001 981 99 05	STRB
				F 15159	006 981 35 05	STRB

Eixo Dianteiro / Eje Delantero / Front Axle

Roda / Rueda / Wheel		•		F 15051 C	005 981 30 05	STRB
	•			32310 F	001 981 74 05	TRB

L 1620

Caixa de Transferência / Caja de Transferencia / Transfer Case

				33210 F	003 981 83 05	TRB
--	--	--	--	----------------	---------------	-----

Eixo Traseiro / Eje Trasero / Rear Axle

Diferencial / Diferencial / Differential				33115 F	003 981 30 05	TRB
				F 15083	003 981 19 05	STRB
				32314 BF	003 981 31 05	TRB
Diferencial - eixo (traseiro) / Diferencial - eje (trasero) / Differential - shaft (rear)				32017 XF	184623	TRB
				32018 XF	004 981 43 05	TRB
				32020 XF	001 981 64 05	TRB
				F 15082	001 981 99 05	STRB
				F 15159	006 981 35 05	STRB



MERCEDES BENZ (CA)

L 1620

Eixo Dianteiro / Eje Delantero / Front Axle

Roda / Rueda / Wheel		•		F 15051 C	005 981 30 05	STRB
	•			32310 F	001 981 74 05	TRB

L 1714 * L 1715 * L 1718 * L 1720 * L 1721 * L 1722 * L 1723 * L 1724 * L 1728

Eixo Traseiro / Eje Trasero / Rear Axle

Diferencial / Diferencial / Differential				F 15083	003 981 19 05	STRB
Diferencial - eixo (traseiro) / Diferencial - eje (trasero) / Differential - shaft (rear)				32017 XF	184623	TRB
				32018 XF	004 981 43 05	TRB
				32020 XF	001 981 64 05	TRB
				F 15082	001 981 99 05	STRB
				F 15159	006 981 35 05	STRB

Eixo Dianteiro / Eje Delantero / Front Axle

Roda / Rueda / Wheel				F 15051 C	005 981 30 05	STRB
	•			33213 F	006 981 63 05	TRB
	•			32310 F	001 981 74 05	TRB

L 1819 * L 1820 * L 1833

Eixo Traseiro / Eje Trasero / Rear Axle

Diferencial - eixo (traseiro) / Diferencial - eje (trasero) / Differential - shaft (rear)				32017 XF	184623	TRB
				32020 XF	001 981 64 05	TRB
Roda / Rueda / Wheel				498 / 492 A	0039812005	TRB

L 2213 * L 2214 * L 2215 * L 2216 * L 2217 * L 2219 * L 2220

Caixa de Transferência / Caja de Transferencia / Transfer Case

				33210 F	003 981 83 05	TRB
--	--	--	--	----------------	---------------	-----

Caixa de Mudanças / Caja de Cambios / Gearbox

				33011 F	005 981 44 05	TRB
--	--	--	--	----------------	---------------	-----

Eixo Traseiro / Eje Trasero / Rear Axle

Diferencial - eixo (traseiro) / Diferencial - eje (trasero) / Differential - shaft (rear)				32018 XF	004 981 43 05	TRB
				F 15159	006 981 35 05	STRB

L 2222 * L 2225 * L 2314 * L 2318 * L 2325

Caixa de Transferência / Caja de Transferencia / Transfer Case

				33210 F	003 981 83 05	TRB
--	--	--	--	----------------	---------------	-----

Caixa de Mudanças / Caja de Cambios / Gearbox

				33011 F	005 981 44 05	TRB
--	--	--	--	----------------	---------------	-----

Eixo Traseiro / Eje Trasero / Rear Axle

Diferencial - eixo (traseiro) / Diferencial - eje (trasero) / Differential - shaft (rear)				32018 XF	004 981 43 05	TRB
				F 15159	006 981 35 05	STRB

L 2414 * L 2418 * L 2420 * L 2423 * L 2424 * L 2428

Eixo Traseiro / Eje Trasero / Rear Axle

Diferencial / Diferencial / Differential				F 15083	003 981 19 05	STRB
Diferencial - eixo (traseiro) / Diferencial - eje (trasero) / Differential - shaft (rear)				32018 XF	004 981 43 05	TRB
				F 15082	001 981 99 05	STRB

	OUT	IN		Fersa®	N° OEM	
---	-----	----	---	---------------	--------	---

MERCEDES BENZ (CA)

L 331

Caixa de Transferência / Caja de Transferencia / Transfer Case

				33210 F	003 981 83 05	TRB
--	--	--	--	---------	---------------	-----

Caixa de Mudanças / Caja de Cambios / Gearbox

				33011 F	005 981 44 05	TRB
--	--	--	--	---------	---------------	-----

Eixo Dianteiro / Eje Delantero / Front Axle

Roda / Rueda / Wheel	•			32309 F	004 981 13 05	TRB
----------------------	---	--	--	---------	---------------	-----

Eixo Traseiro / Eje Trasero / Rear Axle

Roda / Rueda / Wheel		•		32218 F	072 003 22 18	TRB
				32219 F	000 981 21 05	TRB

L 608 * L 708 * L 709 * L 710 * L 712 * L 714 * L 715 * L 718

Caixa de Mudanças / Caja de Cambios / Gearbox

				32208 F	LA5113	TRB
				32210 F	LA5115	TRB

Eixo Dianteiro / Eje Delantero / Front Axle

Roda / Rueda / Wheel				33109 F	003 981 16 05	TRB
				33205 F	006 981 58 05	TRB
				32306 F	3129810205	TRB

Eixo Dianteiro e Traseiro / Eje Delantero y Trasero / Front and Rear Axle

				33111 F	000 980 75 02	TRB
--	--	--	--	---------	---------------	-----

Eixo Traseiro / Eje Trasero / Rear Axle

Roda / Rueda / Wheel				33895 / 33822	002 981 05 05	TRB
----------------------	--	--	--	---------------	---------------	-----

L 809 * L 812 * L 814 * L 817

Caixa de Mudanças / Caja de Cambios / Gearbox

				32208 F	LA5113	TRB
--	--	--	--	---------	--------	-----

Eixo Dianteiro / Eje Delantero / Front Axle

Roda / Rueda / Wheel				32306 F	3129810205	TRB
----------------------	--	--	--	---------	------------	-----

L 911 * L 912 * L 913 * L 914

Caixa de Transferência / Caja de Transferencia / Transfer Case

				33210 F	003 981 83 05	TRB
--	--	--	--	---------	---------------	-----

Caixa de Mudanças / Caja de Cambios / Gearbox

				33011 F	005 981 44 05	TRB
				30306 F	001 981 57 05	TRB
				32208 F	LA5113	TRB
				32210 F	LA5115	TRB

Eixo Dianteiro / Eje Delantero / Front Axle

Roda / Rueda / Wheel				33109 F	003 981 16 05	TRB
				33205 F	006 981 58 05	TRB
				32306 F	3129810205	TRB

Eixo Dianteiro e Traseiro / Eje Delantero y Trasero / Front and Rear Axle

				33111 F	000 980 75 02	TRB
--	--	--	--	---------	---------------	-----

Eixo Traseiro / Eje Trasero / Rear Axle

Roda / Rueda / Wheel				33895 / 33822	002 981 05 05	TRB
----------------------	--	--	--	---------------	---------------	-----

	OUT	IN		Fersa®	Nº OEM	
---	-----	----	---	---------------	--------	---

MERCEDES BENZ (CA)

LA 1313 * LA 1314 * LA 1315 * LA 1316 * LA 1317 * LA 1318 * LA 1319 * LA 1320

Caixa de Transferência / Caja de Transferencia / Transfer Case

				33210 F	003 981 83 05	TRB
--	--	--	--	----------------	---------------	-----

Caixa de Mudanças / Caja de Cambios / Gearbox

				33011 F	005 981 44 05	TRB
--	--	--	--	----------------	---------------	-----

Eixo Traseiro / Eje Trasero / Rear Axle

Diferencial / Diferencial / Differential				F 15083	003 981 19 05	STRB
--	--	--	--	----------------	---------------	------

Diferencial - pinhão eixo (dianteiro/traseiro) /
 Diferencial - piñón eje (delantero/trasero) /
 Differential - shaft pinion (front/rear)

				F 15158	012 981 85 05	STRB
--	--	--	--	----------------	---------------	------

Eixo Dianteiro / Eje Delantero / Front Axle

Roda / Rueda / Wheel				497 / 492 A	000 981 61 05	TRB
----------------------	--	--	--	--------------------	---------------	-----

LA 1418 * LA 1419 * LA 1420

Eixo Dianteiro / Eje Delantero / Front Axle

Roda / Rueda / Wheel				559 / 552 A	3449817005	TRB
----------------------	--	--	--	--------------------	------------	-----

LA 2213 6X6 * LA 2214 6X6 * LA2215 6X6 * LA2216 6X6 * LA2217 6X6 * LA2219 6X6 * LA2220 6X6 * LA2225 6X6

Caixa de Transferência / Caja de Transferencia / Transfer Case

				33210 F	003 981 83 05	TRB
--	--	--	--	----------------	---------------	-----

Caixa de Mudanças / Caja de Cambios / Gearbox

				33011 F	005 981 44 05	TRB
--	--	--	--	----------------	---------------	-----

Eixo Traseiro / Eje Trasero / Rear Axle

Diferencial - eixo (traseiro) / Diferencial - eje (trasero) / Differential - shaft (rear)				F 15159	006 981 35 05	STRB
--	--	--	--	----------------	---------------	------

Eixo Dianteiro / Eje Delantero / Front Axle

Roda / Rueda / Wheel	•			32307 F	003 981 64 05	TRB
----------------------	---	--	--	----------------	---------------	-----

LAK 1113 * LAK 1116 * LAK 1118

Eixo Dianteiro / Eje Delantero / Front Axle

Roda / Rueda / Wheel				30312 F	001 981 97 05	TRB
----------------------	--	--	--	----------------	---------------	-----

LAK 1313 * LAK 1314 * LAK 1315 * LAK 1316 * LAK 1317 * LAK 1318 * LAK 1320

Caixa de Transferência / Caja de Transferencia / Transfer Case

				33210 F	003 981 83 05	TRB
--	--	--	--	----------------	---------------	-----

Caixa de Mudanças / Caja de Cambios / Gearbox

				33011 F	005 981 44 05	TRB
--	--	--	--	----------------	---------------	-----

Eixo Traseiro / Eje Trasero / Rear Axle

Diferencial / Diferencial / Differential				F 15083	003 981 19 05	STRB
--	--	--	--	----------------	---------------	------

Diferencial - pinhão eixo (dianteiro/traseiro) /
 Diferencial - piñón eje (delantero/trasero) /
 Differential - shaft pinion (front/rear)

				F 15158	012 981 85 05	STRB
--	--	--	--	----------------	---------------	------

Eixo Dianteiro / Eje Delantero / Front Axle

Roda / Rueda / Wheel				497 / 492 A	000 981 61 05	TRB
----------------------	--	--	--	--------------------	---------------	-----

LAK 1418 * LAK 1419 * LAK 1420

Eixo Dianteiro / Eje Delantero / Front Axle

Roda / Rueda / Wheel				559 / 552 A	3449817005	TRB
----------------------	--	--	--	--------------------	------------	-----

LAK 1524 * LAK 1525

Eixo Traseiro / Eje Trasero / Rear Axle

Diferencial / Diferencial / Differential				F 15083	003 981 19 05	STRB
--	--	--	--	----------------	---------------	------

Diferencial - eixo (traseiro) / Diferencial - eje (trasero) /
 Differential - shaft (rear)

				32017 XF	184623	TRB
--	--	--	--	-----------------	--------	-----

				32018 XF	004 981 43 05	TRB
--	--	--	--	-----------------	---------------	-----

				32020 XF	001 981 64 05	TRB
--	--	--	--	-----------------	---------------	-----

Diferencial - eixo (traseiro) / Diferencial - eje (trasero) /
 Differential - rear shaft

				F 15082	001 981 99 05	STRB
--	--	--	--	----------------	---------------	------

				F 15159	006 981 35 05	STRB
--	--	--	--	----------------	---------------	------

	OUT	IN		Fersa®	N° OEM	
---	-----	----	---	---------------	--------	---

MERCEDES BENZ (CA)

LAK 1524 * LAK 1525

Eixo Traseiro / Eje Trasero / Rear Axle

Roda / Rueda / Wheel		•		32218 F	072 003 22 18	TRB
----------------------	--	---	--	----------------	---------------	-----

LA K1819 * LAK 1820 * LAK 1833

Eixo Traseiro / Eje Trasero / Rear Axle

Diferencial - eixo (traseiro) / Diferencial - eje (trasero) / Differential - shaft (rear)				32017 XF	184623	TRB
				32020 XF	001 981 64 05	TRB

LAK 2013 6X2 * LAK 2014 * LAK 2016 * LAK 2017

Eixo Traseiro / Eje Trasero / Rear Axle

Roda / Rueda / Wheel				498 / 492 A	0039812005	TRB
----------------------	--	--	--	--------------------	------------	-----

LAK 2213 * LAK 2214 * LAK 2215 * LAK 2216 * LAK 2217 * LAK 2219 * LAK 2220 * LAK 2222 * LAK 2225

Caixa de Transferência / Caja de Transferencia / Transfer Case

				33210 F	003 981 83 05	TRB
--	--	--	--	----------------	---------------	-----

Caixa de Mudanças / Caja de Cambios / Gearbox

Eixo primário / Eje primario / Primary shaft				33011 F	005 981 44 05	TRB
--	--	--	--	----------------	---------------	-----

Eixo Traseiro / Eje Trasero / Rear Axle

Diferencial - eixo (traseiro) / Diferencial - eje (trasero) / Differential - shaft (rear)				F 15159	006 981 35 05	STRB
				32212 F	3129810101	TRB

Eixo Dianteiro / Eje Delantero / Front Axle

Roda / Rueda / Wheel				30312 F	001 981 97 05	TRB
----------------------	--	--	--	----------------	---------------	-----

LAS1111

Eixo Traseiro / Eje Trasero / Rear Axle

Remolque Eixos / Remolque ejes / Trailer axles		•	HL4/7 * 6-HL4/25	32216 F	000 981 72 05	TRB
--	--	---	------------------	----------------	---------------	-----

LAS 1113 * LAS 1114 * LAS 1116 * LAS 1118

Eixo Dianteiro / Eje Delantero / Front Axle

Roda / Rueda / Wheel				30312 F	001 981 97 05	TRB
----------------------	--	--	--	----------------	---------------	-----

LAS 1313 * LAS 1314 * LAS 1315 * LAS 1316 * LAS 1317 * LAS 1318 * LAS1319 * LAS 1320

Caixa de Transferência / Caja de Transferencia / Transfer Case

				33210 F	003 981 83 05	TRB
--	--	--	--	----------------	---------------	-----

Caixa de Mudanças / Caja de Cambios / Gearbox

				33011 F	005 981 44 05	TRB
--	--	--	--	----------------	---------------	-----

Eixo Traseiro / Eje Trasero / Rear Axle

Diferencial / Diferencial / Differential				F 15083	003 981 19 05	STRB
Diferencial - pinhão eixo (dianteiro/traseiro) / Diferencial - piñón eje (delantero/trasero) / Differential - shaft pinion (front/rear)				F 15158	012 981 85 05	STRB

Eixo Dianteiro / Eje Delantero / Front Axle

Roda / Rueda / Wheel				497 / 492 A	000 981 61 05	TRB
----------------------	--	--	--	--------------------	---------------	-----

LB 1116 * LB 1117 * LB 1118

Eixo Dianteiro / Eje Delantero / Front Axle

Roda / Rueda / Wheel				30312 F	001 981 97 05	TRB
----------------------	--	--	--	----------------	---------------	-----

LB 1314 * LB 1315 * LB 1316 * LB 1317 * LB 1318 * LB 1319 * LB 1320

Eixo Traseiro / Eje Trasero / Rear Axle

Diferencial / Diferencial / Differential				F 15083	003 981 19 05	STRB
Diferencial - pinhão eixo (dianteiro/traseiro) / Diferencial - piñón eje (delantero/trasero) / Differential - shaft pinion (front/rear)				F 15158	012 981 85 05	STRB
Roda / Rueda / Wheel				598 A / 593 X	0039811405	TRB

	OUT	IN		Fersa®	N° OEM	
MERCEDES BENZ (CA)						
LB 1314 * LB 1315 * LB 1316 * LB 1317 * LB 1318 * LB 1319 * LB 1320						
Eixo Dianteiro / Eje Delantero / Front Axle						
Roda / Rueda / Wheel				497 / 492 A	000 981 61 05	TRB
LB 1524 * LB 1525						
Eixo Traseiro / Eje Trasero / Rear Axle						
Diferencial / Diferencial / Differential				F 15083	003 981 19 05	STRB
Diferencial - eixo (traseiro) / Diferencial - eje (trasero) / Differential - shaft (rear)				32017 XF	184623	TRB
				32018 XF	004 981 43 05	TRB
				32020 XF	001 981 64 05	TRB
				F 15082	001 981 99 05	STRB
				F 15159	006 981 35 05	STRB
Roda / Rueda / Wheel		•		32218 F	072 003 22 18	TRB
LB 2220 * LB 2222 * LB 2225						
Caixa de Transferência / Caja de Transferencia / Transfer Case						
				33210 F	003 981 83 05	TRB
Caixa de Mudanças / Caja de Cambios / Gearbox						
				33011 F	005 981 44 05	TRB
Eixo Traseiro / Eje Trasero / Rear Axle						
Diferencial - eixo (traseiro) / Diferencial - eje (trasero) / Differential - shaft (rear)				F 15159	006 981 35 05	STRB
LB 2314 * LB 2318 * LB 2325						
Caixa de Transferência / Caja de Transferencia / Transfer Case						
				33210 F	003 981 83 05	TRB
Caixa de Mudanças / Caja de Cambios / Gearbox						
				33011 F	005 981 44 05	TRB
Eixo Traseiro / Eje Trasero / Rear Axle						
Diferencial - eixo (traseiro) / Diferencial - eje (trasero) / Differential - shaft (rear)				F 15159	006 981 35 05	STRB
LB 2414 * LB 2418 * LB 2420 * LB 2423 * LB 2424 * LB 2428						
Eixo Traseiro / Eje Trasero / Rear Axle						
Diferencial - eixo (traseiro) / Diferencial - eje (trasero) / Differential - shaft (rear)				F 15159	006 981 35 05	STRB
LG 1524 * LG 1525						
Eixo Traseiro / Eje Trasero / Rear Axle						
Diferencial / Diferencial / Differential				F 15083	003 981 19 05	STRB
Diferencial - eixo (traseiro) / Diferencial - eje (trasero) / Differential - shaft (rear)				32017 XF	184623	TRB
				32018 XF	004 981 43 05	TRB
				32020 XF	001 981 64 05	TRB
				F 15082	001 981 99 05	STRB
				F 15159	006 981 35 05	STRB
Roda / Rueda / Wheel		•		32218 F	072 003 22 18	TRB
LG 1819 * LG 1820						
Caixa de Transferência / Caja de Transferencia / Transfer Case						
				33210 F	003 981 83 05	TRB
Caixa de Mudanças / Caja de Cambios / Gearbox						
				33011 F	005 981 44 05	TRB

	OUT	IN		Fersa®	N° OEM	
---	-----	----	---	---------------	--------	---

MERCEDES BENZ (CA)

LG 2013 6X2

Eixo Traseiro / Eje Trasero / Rear Axle

Roda / Rueda / Wheel				598 A / 593 X	0039811405	TRB
----------------------	--	--	--	----------------------	------------	-----

LG 2213 * LG 2214 * LG 2215 * LG 2216 * LG 2217 * LG 2219 * LG 2220 * LG 2222 * LG 2225

Eixo Traseiro / Eje Trasero / Rear Axle

Roda / Rueda / Wheel				598 A / 593 X	0039811405	TRB
----------------------	--	--	--	----------------------	------------	-----

LK 1113 * LK 1114 * LK 1116 * LK 1117 * LK 1118

Eixo Dianteiro / Eje Delantero / Front Axle

Roda / Rueda / Wheel				30312 F	001 981 97 05	TRB
	•			32307 F	003 981 64 05	TRB

LK 1214 * LK 1215 * LK 1217 * LK 1218

Eixo Traseiro / Eje Trasero / Rear Axle

Diferencial / Diferencial / Differential				33020 F	005 981 84 05	TRB
Roda / Rueda / Wheel		•		33020 F	005 981 84 05	TRB

LK 1313 * LK 1314 * LK 1315 * LK 1316 * LK 1317 * LK 1318 * LK 1319 * LK 1320 * LK 1321

Caixa de Transferência / Caja de Transferencia / Transfer Case

				33210 F	003 981 83 05	TRB
--	--	--	--	----------------	---------------	-----

Caixa de Mudanças / Caja de Cambios / Gearbox

				33011 F	005 981 44 05	TRB
			Tremec CL559 No. Fuller	M 804049 / M 804010		TRB
			Tremec CL559 No. Fuller 235418	M 804049 / M 804010		TRB
			Tremec CL559 No. Fuller 654166 / 791943	25590 / 25520		TRB

Eixo Traseiro / Eje Trasero / Rear Axle

Diferencial / Diferencial / Differential				F 15083	003 981 19 05	STRB
Diferencial - pinhão eixo (dianteiro/traseiro) / Diferencial - piñón eje (delantero/trasero) / Differential - shaft pinion (front/rear)				F 15158	012 981 85 05	STRB
Roda / Rueda / Wheel				598 A / 593 X	0039811405	TRB

Eixo Dianteiro / Eje Delantero / Front Axle

Roda / Rueda / Wheel				33214 F	003 981 52 05	TRB
				497 / 492 A	000 981 61 05	TRB

LK 1414 * LK 1416

Caixa de Mudanças / Caja de Cambios / Gearbox

				32208 F	LA5113	TRB
--	--	--	--	----------------	--------	-----

Eixo Traseiro / Eje Trasero / Rear Axle

Diferencial / Diferencial / Differential				F 15083	003 981 19 05	STRB
Diferencial - eixo (traseiro) / Diferencial - eje (trasero) / Differential - shaft (rear)				32017 XF	184623	TRB
				32018 XF	004 981 43 05	TRB
				32020 XF	001 981 64 05	TRB
				F 15082	001 981 99 05	STRB

LK 1524 * LK 1525

Eixo Traseiro / Eje Trasero / Rear Axle

Diferencial / Diferencial / Differential				F 15083	003 981 19 05	STRB
Diferencial - eixo (traseiro) / Diferencial - eje (trasero) / Differential - shaft (rear)				32017 XF	184623	TRB

	OUT	IN		Fersa®	Nº OEM	
---	-----	----	---	---------------	--------	---

MERCEDES BENZ (CA)

LK 1524 * LK 1525

Eixo Traseiro / Eje Trasero / Rear Axle

Diferencial - eixo (traseiro) / Diferencial - eje (trasero) / Differential - rear shaft				32018 XF	004 981 43 05	TRB
				32020 XF	001 981 64 05	TRB
				F 15082	001 981 99 05	STRB
				F 15159	006 981 35 05	STRB
Roda / Rueda / Wheel		•		32218 F	072 003 22 18	TRB

LK 1614 * LK 1615 * LK 1617 * LK 1618 * LK 1620 * LK 1621 * LK 1622 * LK 1623 * LK 1625 * LK 1630 * LK 1633 * LK 1634

Caixa de Transferência / Caja de Transferencia / Transfer Case

				33210 F	003 981 83 05	TRB
--	--	--	--	----------------	---------------	-----

Eixo Traseiro / Eje Trasero / Rear Axle

Diferencial / Diferencial / Differential				33115 F	003 981 30 05	TRB
				F 15083	003 981 19 05	STRB
				32314 BF	003 981 31 05	TRB
Diferencial - eixo (traseiro) / Diferencial - eje (trasero) / Differential - shaft (rear)				32017 XF	184623	TRB
				32018 XF	004 981 43 05	TRB
				32020 XF	001 981 64 05	TRB
				F 15082	001 981 99 05	STRB
				F 15159	006 981 35 05	STRB

Eixo Dianteiro / Eje Delantero / Front Axle

Roda / Rueda / Wheel				F 15051 C	005 981 30 05	STRB
	•			32310 F	001 981 74 05	TRB

LK 1714 * LK 1715 * LK 1718 * LK 1720 * LK 1721 * LK 1722 * LK 1723 * LK 1724 * LK 1728

Eixo Traseiro / Eje Trasero / Rear Axle

Diferencial / Diferencial / Differential				F 15083	003 981 19 05	STRB
Diferencial - eixo (traseiro) / Diferencial - eje (trasero) / Differential - shaft (rear)				32017 XF	184623	TRB
				32018 XF	004 981 43 05	TRB
				32020 XF	001 981 64 05	TRB
				F 15082	001 981 99 05	STRB
				F 15159	006 981 35 05	STRB

Eixo Dianteiro / Eje Delantero / Front Axle

Roda / Rueda / Wheel				F 15051 C	005 981 30 05	STRB
	•			33213 F	006 981 63 05	TRB
	•			32310 F	001 981 74 05	TRB

LK 2013 6X2 * LK 2014 * LK 2016 * LK 2017 * LK 2024 * LK 2036 * LK 2042

Eixo Traseiro / Eje Trasero / Rear Axle

Diferencial - eixo (traseiro) / Diferencial - eje (trasero) / Differential - shaft (rear)				32018 XF	004 981 43 05	TRB
				F 15159	006 981 35 05	STRB
Roda / Rueda / Wheel				498 / 492 A	0039812005	TRB
				598 A / 593 X	0039811405	TRB

LK 2213 * LK 2214 * LK 2215 * LK 2216 * LK 2217 * LK 2219 * LK 2220 * LK 2222 * LK 2225

Caixa de Transferência / Caja de Transferencia / Transfer Case

				33210 F	003 981 83 05	TRB
--	--	--	--	----------------	---------------	-----

Caixa de Mudanças / Caja de Cambios / Gearbox

				33011 F	005 981 44 05	TRB
--	--	--	--	----------------	---------------	-----

Eixo Traseiro / Eje Trasero / Rear Axle

Diferencial - eixo (traseiro) / Diferencial - eje (trasero) / Differential - shaft (rear)				32018 XF	004 981 43 05	TRB
Roda / Rueda / Wheel				598 A / 593 X	0039811405	TRB

	OUT	IN		Fersa®	N° OEM	
---	-----	----	---	---------------	--------	---

MERCEDES BENZ (CA)

LK 2314 * LK 2318 * LK 2325

Caixa de Transferência / Caja de Transferencia / Transfer Case

				33210 F	003 981 83 05	TRB
--	--	--	--	----------------	---------------	-----

Caixa de Mudanças / Caja de Cambios / Gearbox

				33011 F	005 981 44 05	TRB
--	--	--	--	----------------	---------------	-----

Eixo Traseiro / Eje Trasero / Rear Axle

Diferencial - eixo (traseiro) / Diferencial - eje (trasero) / Differential - shaft (rear)

				F 15159	006 981 35 05	STRB
--	--	--	--	----------------	---------------	------

LK 2414 * LK 2418 * LK 2420 * LK 2423 * LK 2424 * LK 2428 * LK 2429

Eixo Traseiro / Eje Trasero / Rear Axle

Diferencial / Diferencial / Differential

				F 15083	003 981 19 05	STRB
--	--	--	--	----------------	---------------	------

Diferencial - eixo (traseiro) / Diferencial - eje (trasero) / Differential - shaft (rear)

				F 15082	001 981 99 05	STRB
--	--	--	--	----------------	---------------	------

LK 2629 * LK 2635 * LK 2638 * LK 2654

Eixo Traseiro / Eje Trasero / Rear Axle

Diferencial / Diferencial / Differential

				32314 BF	003 981 31 05	TRB
--	--	--	--	-----------------	---------------	-----

Diferencial - eixo (traseiro) / Diferencial - eje (trasero) / Differential - shaft (rear)

				32018 XF	004 981 43 05	TRB
--	--	--	--	-----------------	---------------	-----

				F 15159	006 981 35 05	STRB
--	--	--	--	----------------	---------------	------

Eixo Dianteiro / Eje Delantero / Front Axle

Roda / Rueda / Wheel

				F 15051 C	005 981 30 05	STRB
--	--	--	--	------------------	---------------	------

LK 312

Caixa de Mudanças / Caja de Cambios / Gearbox

				30306 F	001 981 57 05	TRB
--	--	--	--	----------------	---------------	-----

Eixo Traseiro / Eje Trasero / Rear Axle

Diferencial - eixo (traseiro) / Diferencial - eje (trasero) / Differential - shaft (rear)

				32212 F	3129810101	TRB
--	--	--	--	----------------	------------	-----

Roda / Rueda / Wheel

				32214 F	3129810001	TRB
--	--	--	--	----------------	------------	-----

Eixo Dianteiro / Eje Delantero / Front Axle

Roda / Rueda / Wheel

				30312 F	001 981 97 05	TRB
--	--	--	--	----------------	---------------	-----

				32306 F	3129810205	TRB
--	--	--	--	----------------	------------	-----

LK 3238 6X4 KS

Eixo Traseiro / Eje Trasero / Rear Axle

Diferencial / Diferencial / Differential

				32314 BF	003 981 31 05	TRB
--	--	--	--	-----------------	---------------	-----

Eixo Dianteiro / Eje Delantero / Front Axle

Roda / Rueda / Wheel

				F 15051 C	005 981 30 05	STRB
--	--	--	--	------------------	---------------	------

LO 1417 59

Eixo Traseiro / Eje Trasero / Rear Axle

Diferencial (dir.) / Diferencial (der.) / Differential (right)

				497 / 493	7451380	TRB
--	--	--	--	------------------	---------	-----

Diferencial - (esq.) / Diferencial - (izq.) / Differential (left)

				56425 / 56650		TRB
--	--	--	--	----------------------	--	-----

Diferencial - pinhão cabeça / Diferencial - piñón cabeza / Differential - pinion head

				72200 C / 72487		TRB
--	--	--	--	------------------------	--	-----

Diferencial - pinhão cola / Diferencial - piñón cola / Differential - pinion (rear)

				55200 C / 55437		TRB
--	--	--	--	------------------------	--	-----

Roda / Rueda / Wheel

	•			39590 / 39520	2986843	TRB
--	---	--	--	----------------------	---------	-----

		•		47686 / 47620	7EQH1238	TRB
--	--	---	--	----------------------	----------	-----

	OUT	IN		Fersa®	Nº OEM	
---	-----	----	---	---------------	--------	---

MERCEDES BENZ (CA)

LO 1417 59

Eixo Dianteiro / Eje Delantero / Front Axle

Roda / Rueda / Wheel	•			3782 / 3720	B5QM1216A/9N4222	TRB
		•		HM 212049 / HM 212011		TRB

LO 608 * LO 708

Caixa de Mudanças / Caja de Cambios / Gearbox

				32208 F	LA5113	TRB
--	--	--	--	----------------	--------	-----

Eixo Dianteiro / Eje Delantero / Front Axle

Roda / Rueda / Wheel				32306 F	3129810205	TRB
----------------------	--	--	--	----------------	------------	-----

Eixo Dianteiro e Traseiro / Eje Delantero y Trasero / Front and Rear Axle

Roda / Rueda / Wheel				33111 F	000 980 75 02	TRB
----------------------	--	--	--	----------------	---------------	-----

Eixo Traseiro / Eje Trasero / Rear Axle

Roda / Rueda / Wheel				33895 / 33822	002 981 05 05	TRB
----------------------	--	--	--	----------------------	---------------	-----

LO 709 * LO 710 * LO 712

Caixa de Transferência / Caja de Transferencia / Transfer Case

				33210 F	003 981 83 05	TRB
--	--	--	--	----------------	---------------	-----

Caixa de Mudanças / Caja de Cambios / Gearbox

				30306 F	001 981 57 05	TRB
				32208 F	LA5113	TRB
				32210 F	LA5115	TRB
				33011 F	005 981 44 05	TRB
				32210 F	LA5115	TRB
			GMC6-100 * 6-150 * 12-170 * 14-190 * 15-190	32210 F	LA5115	TRB

Eixo Traseiro / Eje Trasero / Rear Axle

				30308 F		TRB
--	--	--	--	----------------	--	-----

Diferencial - eixo (traseiro) / Diferencial - eje (trasero) / Differential - shaft (rear)				32017 XF	184623	TRB
--	--	--	--	-----------------	--------	-----

Roda / Rueda / Wheel				33895 / 33822	002 981 05 05	TRB
----------------------	--	--	--	----------------------	---------------	-----

Eixo Dianteiro / Eje Delantero / Front Axle

Roda / Rueda / Wheel				33109 F	003 981 16 05	TRB
----------------------	--	--	--	----------------	---------------	-----

				33205 F	006 981 58 05	TRB
--	--	--	--	----------------	---------------	-----

				32306 F	3129810205	TRB
--	--	--	--	----------------	------------	-----

Eixo Dianteiro e Traseiro / Eje Delantero y Trasero / Front and Rear Axle

Roda / Rueda / Wheel				33111 F	000 980 75 02	TRB
----------------------	--	--	--	----------------	---------------	-----

LO 914

Eixo Dianteiro / Eje Delantero / Front Axle

Roda / Rueda / Wheel				33109 F	003 981 16 05	TRB
----------------------	--	--	--	----------------	---------------	-----

				33205 F	006 981 58 05	TRB
--	--	--	--	----------------	---------------	-----

				32306 F	3129810205	TRB
--	--	--	--	----------------	------------	-----

Eixo Dianteiro e Traseiro / Eje Delantero y Trasero / Front and Rear Axle

Roda / Rueda / Wheel				33111 F	000 980 75 02	TRB
----------------------	--	--	--	----------------	---------------	-----

LP 1114 * LPO 1114 * LS 1114

Eixo Dianteiro / Eje Delantero / Front Axle

Roda / Rueda / Wheel				30312 F	001 981 97 05	TRB
----------------------	--	--	--	----------------	---------------	-----

				30312 F	001 981 97 05	TRB
--	--	--	--	----------------	---------------	-----

	OUT	IN		Fersa®	N° OEM	
---	-----	----	---	---------------	--------	---

MERCEDES BENZ (CA)

LP 1116 * LPO 1116 * LS 1116

Eixo Dianteiro / Eje Delantero / Front Axle

Roda / Rueda / Wheel				30312 F	001 981 97 05	TRB
----------------------	--	--	--	----------------	---------------	-----

LP 1117 * LPO 1117 * LS 1117

Eixo Dianteiro / Eje Delantero / Front Axle

Roda / Rueda / Wheel				30312 F	001 981 97 05	TRB
----------------------	--	--	--	----------------	---------------	-----

LP 1118 * LPO 1118 * LS 1118

Eixo Dianteiro / Eje Delantero / Front Axle

Roda / Rueda / Wheel				30312 F	001 981 97 05	TRB
----------------------	--	--	--	----------------	---------------	-----

LP 1312

Caixa de Mudanças / Caja de Cambios / Gearbox

				30306 F	001 981 57 05	TRB
--	--	--	--	----------------	---------------	-----

Eixo Traseiro / Eje Trasero / Rear Axle

Diferencial - eixo (traseiro) / Diferencial - eje (trasero) / Differential - shaft (rear)				32212 F	3129810101	TRB
---	--	--	--	----------------	------------	-----

Roda / Rueda / Wheel				32214 F	3129810001	TRB
----------------------	--	--	--	----------------	------------	-----

Eixo Dianteiro / Eje Delantero / Front Axle

Roda / Rueda / Wheel				30312 F	001 981 97 05	TRB
----------------------	--	--	--	----------------	---------------	-----

				32306 F	3129810205	TRB
--	--	--	--	----------------	------------	-----

LP 1313 * LP 1314 * LP 1315 * LP 1316 * LP 1317 * LP 1318 * LP 1320

Eixo Traseiro / Eje Trasero / Rear Axle

Diferencial - pinhão eixo (dianteiro/traseiro) / Diferencial - piñón eje (delantero/traseiro) / Differential - shaft pinion (front/rear)				F 15158	012 981 85 05	STRB
--	--	--	--	----------------	---------------	------

Eixo Dianteiro / Eje Delantero / Front Axle

Roda / Rueda / Wheel				497 / 492 A	000 981 61 05	TRB
----------------------	--	--	--	--------------------	---------------	-----

LP 1520 * LPK 1520 * LPS 1520

Eixo Traseiro / Eje Trasero / Rear Axle

Diferencial - eixo (traseiro) / Diferencial - eje (trasero) / Differential - shaft (rear)				32017 XF	184623	TRB
---	--	--	--	-----------------	--------	-----

				H 715345 / H 715311	181342	TRB
--	--	--	--	----------------------------	--------	-----

Eixo Dianteiro / Eje Delantero / Front Axle

Roda / Rueda / Wheel	•			32309 F	004 981 13 05	TRB
----------------------	---	--	--	----------------	---------------	-----

LP 1524 * LPK 1524 * LPS 1524 * LS 1524

Eixo Traseiro / Eje Trasero / Rear Axle

Diferencial - eixo (traseiro) / Diferencial - eje (trasero) / Differential - shaft (rear)				32018 XF	004 981 43 05	TRB
---	--	--	--	-----------------	---------------	-----

LP 1525 * LPK 1525 * LPS 1525 * LS 1525

Eixo Traseiro / Eje Trasero / Rear Axle

Diferencial / Diferencial / Differential				F 15083	003 981 19 05	STRB
--	--	--	--	----------------	---------------	------

Diferencial - eixo (traseiro) / Diferencial - eje (trasero) / Differential - shaft (rear)				32017 XF	184623	TRB
---	--	--	--	-----------------	--------	-----

				32018 XF	004 981 43 05	TRB
--	--	--	--	-----------------	---------------	-----

				32020 XF	001 981 64 05	TRB
--	--	--	--	-----------------	---------------	-----

				F 15082	001 981 99 05	STRB
--	--	--	--	----------------	---------------	------

				F 15159	006 981 35 05	STRB
--	--	--	--	----------------	---------------	------

Roda / Rueda / Wheel		•		32218 F	072 003 22 18	TRB
----------------------	--	---	--	----------------	---------------	-----

	OUT	IN		Fersa®	Nº OEM	
MERCEDES BENZ (CA)						
LP 321 * LPK 321						
Eixo Traseiro / Eje Trasero / Rear Axle						
Diferencial - eixo (traseiro) / Diferencial - eje (trasero) / Differential - shaft (rear)				32212 F	3129810101	TRB
Roda / Rueda / Wheel				30312 F	001 981 97 05	TRB
LPK 331 * LPS 331						
Caixa de Transferência / Caja de Transferencia / Transfer Case						
				33210 F	003 981 83 05	TRB
Caixa de Mudanças / Caja de Cambios / Gearbox						
				33011 F	005 981 44 05	TRB
Eixo Dianteiro / Eje Delantero / Front Axle						
Roda / Rueda / Wheel	•			32309 F	004 981 13 05	TRB
Eixo Traseiro / Eje Trasero / Rear Axle						
Roda / Rueda / Wheel		•		32218 F	072 003 22 18	TRB
				32219 F	000 981 21 05	TRB
LPO 1313 * LPO 1314 * LPO 1315 * LPO 1316 * LPO 1317 * LPO 1318 * LPO 1320						
Eixo Traseiro / Eje Trasero / Rear Axle						
Diferencial - pinhão eixo (dianteiro/traseiro) / Diferencial - piñón eje (delantero/trasero) / Differential - shaft pinion (front/rear)				F 15158	012 981 85 05	STRB
Eixo Dianteiro / Eje Delantero / Front Axle						
Roda / Rueda / Wheel				497 / 492 A	000 981 61 05	TRB
LS 1314 * LS 1315 * LS 1316 * LS 1317 * LS 1318 * LS 1319						
Eixo Traseiro / Eje Trasero / Rear Axle						
Diferencial / Diferencial / Differential				F 15083	003 981 19 05	STRB
Diferencial - pinhão eixo (dianteiro/traseiro) / Diferencial - piñón eje (delantero/trasero) / Differential - shaft pinion (front/rear)				F 15158	012 981 85 05	STRB
Roda / Rueda / Wheel				598 A / 593 X	0039811405	TRB
Eixo Dianteiro / Eje Delantero / Front Axle						
Roda / Rueda / Wheel				33214 F	003 981 52 05	TRB
				497 / 492 A	000 981 61 05	TRB
LS 1524 * LP 1524 * LPK 1524 * LPS 1524						
Eixo Traseiro / Eje Trasero / Rear Axle						
Diferencial / Diferencial / Differential				F 15083	003 981 19 05	STRB
Diferencial - eixo (traseiro) / Diferencial - eje (trasero) / Differential - shaft (rear)				32020 XF	001 981 64 05	TRB
				F 15082	001 981 99 05	STRB
				F 15159	006 981 35 05	STRB
Roda / Rueda / Wheel		•		32218 F	072 003 22 18	TRB
LS 1929 * LS 1930 * LS 1932 * LS 1933 * LS 1934 * LS 1935 * LS 1937 * LS 1938 * LS 1939 * LS 1941 * LS 1942 * LS 1944 * LS 1945 * LS 1951						
Eixo Traseiro / Eje Trasero / Rear Axle						
Diferencial / Diferencial / Differential				32314 BF	003 981 31 05	TRB
Diferencial - eixo (traseiro) / Diferencial - eje (trasero) / Differential - shaft (rear)				32020 XF	001 981 64 05	TRB
Roda / Rueda / Wheel				33022 F	005 981 21 05	TRB
Eixo Dianteiro / Eje Delantero / Front Axle						
Roda / Rueda / Wheel				F 15051 C	005 981 30 05	STRB

	OUT	IN		Fersa®	N° OEM	
---	-----	----	---	---------------	--------	---

MERCEDES BENZ (CA)

LS 2013 * LS 2014 * LS 2016 * LS 2017 * LS 2024 * LS 2036 * LS 2042

Eixo Dianteiro / Eje Delantero / Front Axle

Roda / Rueda / Wheel				F 15051 C	005 981 30 05	STRB
----------------------	--	--	--	------------------	---------------	------

Eixo Traseiro / Eje Trasero / Rear Axle

Roda / Rueda / Wheel				598 A / 593 X	0039811405	TRB
----------------------	--	--	--	----------------------	------------	-----

LS 2220 * LS 2222 * LS 2225 * LS 2314 * LS 2325

Caixa de Transferência / Caja de Transferencia / Transfer Case

				33210 F	003 981 83 05	TRB
--	--	--	--	----------------	---------------	-----

Caixa de Mudanças / Caja de Cambios / Gearbox

				33011 F	005 981 44 05	TRB
--	--	--	--	----------------	---------------	-----

Eixo Traseiro / Eje Trasero / Rear Axle

Diferencial - eixo (traseiro) / Diferencial - eje (trasero) / Differential - shaft (rear)				F 15159	006 981 35 05	STRB
---	--	--	--	----------------	---------------	------

LS 2629 * LS 2635 * LS 2638 * LS 2654

Eixo Traseiro / Eje Trasero / Rear Axle

Diferencial / Diferencial / Differential				32314 BF	003 981 31 05	TRB
Diferencial - eixo (traseiro) / Diferencial - eje (trasero) / Differential - shaft (rear)				32018 XF	004 981 43 05	TRB
				F 15159	006 981 35 05	STRB

Eixo Dianteiro / Eje Delantero / Front Axle

Roda / Rueda / Wheel				F 15051 C	005 981 30 05	STRB
----------------------	--	--	--	------------------	---------------	------

OF 1111 * OF 1113 * OF 1114 * OF 1115 * OF 1116 * OF 1117 * OF 1118

Eixo Traseiro / Eje Trasero / Rear Axle

Diferencial - pinhão eixo (dianteiro/traseiro) / Diferencial - piñón eje (delantero/trasero) / Differential - shaft pinion (front/rear)				F 15158	012 981 85 05	STRB
---	--	--	--	----------------	---------------	------

Eixo Dianteiro / Eje Delantero / Front Axle

Roda / Rueda / Wheel				30312 F	001 981 97 05	TRB
				497 / 492 A	000 981 61 05	TRB

OF 1215 * OF 1217

Caixa de Mudanças / Caja de Cambios / Gearbox

				32208 F	LA5113	TRB
				32210 F	LA5115	TRB

Eixo Traseiro / Eje Trasero / Rear Axle

Diferencial / Diferencial / Differential				33020 F	005 981 84 05	TRB
Diferencial - eixo (traseiro) / Diferencial - eje (trasero) / Differential - shaft (rear)				32018 XF	004 981 43 05	TRB
				32020 XF	001 981 64 05	TRB
				F 15082	001 981 99 05	STRB
				F 15159	006 981 35 05	STRB
Roda / Rueda / Wheel		●		33020 F	005 981 84 05	TRB

OF 1320

Eixo Traseiro / Eje Trasero / Rear Axle

Diferencial / Diferencial / Differential				F 15083	003 981 19 05	STRB
Diferencial - eixo (traseiro) / Diferencial - eje (trasero) / Differential - shaft (rear)				32018 XF	004 981 43 05	TRB
				32020 XF	001 981 64 05	TRB
Diferencial - eixo (traseiro) / Diferencial - eje (trasero) / Differential - rear shaft				F 15082	001 981 99 05	STRB
				F 15159	006 981 35 05	STRB
Diferencial - pinhão eixo (dianteiro/traseiro) / Diferencial - piñón eje (delantero/trasero) / Differential - shaft pinion (front/rear)				F 15158	012 981 85 05	STRB

	OUT	IN		Fersa®	Nº OEM	
---	-----	----	---	---------------	--------	---

MERCEDES BENZ (CA)

OF 1320

Eixo Dianteiro / Eje Delantero / Front Axle

Roda / Rueda / Wheel				497 / 492 A	000 981 61 05	TRB
----------------------	--	--	--	--------------------	---------------	-----

OF 1416 * OF 1417 * OF 1418 * OF 1419 * OF 1420 * OF 1421

Caixa de Mudanças / Caja de Cambios / Gearbox

				32208 F	LA5113	TRB
--	--	--	--	----------------	--------	-----

Eixo Traseiro / Eje Trasero / Rear Axle

Diferencial / Diferencial / Differential				F 15083	003 981 19 05	STRB
--	--	--	--	----------------	---------------	------

Diferencial - eixo (traseiro) / Diferencial - eje (trasero) / Differential - shaft (rear)				32017 XF	184623	TRB
				32018 XF	004 981 43 05	TRB
				32020 XF	001 981 64 05	TRB

				F 15082	001 981 99 05	STRB
--	--	--	--	----------------	---------------	------

Roda / Rueda / Wheel	•			39590 / 39520	2986843	TRB
		•		47686 / 47620	7EQH1238	TRB

Eixo Dianteiro / Eje Delantero / Front Axle

Roda / Rueda / Wheel	•			3782 / 3720	B5QM1216A/9N4222	TRB
		•		HM 212049 / HM 212011		TRB

OF 1513 * OF 1514

Eixo Traseiro / Eje Trasero / Rear Axle

Diferencial - eixo (traseiro) / Diferencial - eje (trasero) / Differential - shaft (rear)				H 715345 / H 715311	181342	TRB
--	--	--	--	--------------------------------	--------	-----

OF 1517 * OF 1518 * OF 1519 * OF 1520 * OF 1521 * OF 1524 * OF 1525

Eixo Traseiro / Eje Trasero / Rear Axle

Diferencial / Diferencial / Differential				F 15083	003 981 19 05	STRB
--	--	--	--	----------------	---------------	------

Diferencial - eixo (traseiro) / Diferencial - eje (trasero) / Differential - shaft (rear)				32017 XF	184623	TRB
				32018 XF	004 981 43 05	TRB
				32020 XF	001 981 64 05	TRB

				F 15082	001 981 99 05	STRB
--	--	--	--	----------------	---------------	------

				F 15159	006 981 35 05	STRB
--	--	--	--	----------------	---------------	------

				H 715345 / H 715311	181342	TRB
--	--	--	--	--------------------------------	--------	-----

Roda / Rueda / Wheel		•	OF1618 * OF1620, OF1621 * OF1625, OF1628 * OF1630, OF1635 * OF1636	32218 F	072 003 22 18	TRB

Eixo Dianteiro / Eje Delantero / Front Axle

Roda / Rueda / Wheel	•			32310 F	001 981 74 05	TRB
		•		F 15051 C	005 981 30 05	STRB

OF 1618 * OF 1620 * OF 1621 * OF 1625 * OF 1628 * OF 1630 * OF 1635 * OF 1636

Caixa de Transferência / Caja de Transferencia / Transfer Case

			OF1714 * OF1718, OF1721 * OF1725	33210 F	003 981 83 05	TRB
--	--	--	-------------------------------------	----------------	---------------	-----

Eixo Traseiro / Eje Trasero / Rear Axle



Diferencial / Diferencial / Differential				F 15083	003 981 19 05	STRB
--	--	--	--	----------------	---------------	------

				32314 BF	003 981 31 05	TRB
--	--	--	--	-----------------	---------------	-----

Diferencial - eixo (traseiro) / Diferencial - eje (trasero) / Differential - shaft (rear)				32017 XF	184623	TRB
				32018 XF	004 981 43 05	TRB
				32020 XF	001 981 64 05	TRB

				F 15082	001 981 99 05	STRB
--	--	--	--	----------------	---------------	------

				F 15159	006 981 35 05	STRB
--	--	--	--	----------------	---------------	------

	OUT	IN		Fersa®	Nº OEM	
---	-----	----	---	---------------	--------	---

MERCEDES BENZ (SA)

608 (L*LO) * 708 (L*LO) * 809 (LO*OF) * 812 (LO*OF) * 814 LO * 817 O * 914 LO * 709 * 710 * 712 * 712 C * 811 * 911 L * 912 * 913 * 914 * 914 C * 917

Eixo Dianteiro / Eje Delantero / Front Axle

Roda / Rueda / Wheel		•		33109 F	0039811605	TRB
		•		33111 F	0069807205 / 0009807502	TRB
	•			32306 F	0019818705	TRB
	•			33205 F	6889817005	TRB

Eixo Traseiro / Eje Trasero / Rear Axle

Roda / Rueda / Wheel	•			33895 / 33822	0029810505	TRB
	•			33011 F	0029819305	TRB
Diferencial - conjunto da redução / Diferencial - conjunto de reducción / Differential - reduction assembly				32016 XF	0079819005 / 00720032016	TRB

Caixa de Mudanças / Caja de Cambios / Gearbox

Eixo primário (dianteiro) / Eje primario (delantero) / Primary shaft (front)				QJ 208 FM	0009813427	BB4PAC
				QJ 212 FM	3459817627	BB4PAC
Eixo primário (traseiro) / Eje primario (trasero) / Primary shaft (rear)				NU 208 FM	3459817101	CRB
Eixo principal (entrada / saída) / Eje principal (entrada / salida) / Main shaft (input / output)				32210 F	A0159815005	TRB
Eixo Intermediário (dianteiro/traseiro) / Eje Intermedio (delantero/trasero) / Intermediate shaft (front/rear)				32208 F	A0159813405	TRB
				30306 F	0019815705	TRB
				30308 F	0019813105 / 0019815005	TRB
Eixo secundário (dianteiro) / Eje secundario (delantero) / Secondary shaft (front)				QJ 208 FM	0009813427	BB4PAC
				QJ 309 FM	3411117121 / 3459817727	BB4PAC
Eixo secundário (traseiro) / Eje secundario (trasero) / Secondary shaft (rear)				NU 208 FM	3459817101	CRB

Tomada de Potência / Toma de Potencia / Power Take-off

Eixo primário (dianteiro) / Eje primario (delantero) / Primary shaft (front)				32304 F	0019819005	TRB
Eixo primário (traseiro) / Eje primario (trasero) / Primary shaft (rear)				32306 F	3129810205	TRB
Eixo intermediário (dianteiro) / Eje intermedio (delantero) / Intermediate shaft (front)				NJ 304 FM	005412400304	CRB
Eixo intermediário (traseiro) / Eje intermedio (trasero) / Intermediate shaft (rear)				NJ 2206 FM	005412402216	CRB
Eixo secundário (dianteiro) / Eje secundario (delantero) / Secondary shaft (front)				32305 F	007200032305	TRB
Eixo secundário (traseiro) / Eje secundario (trasero) / Secondary shaft (rear)				32306 F	3129810205	TRB

Motor / Motor / Engine

Alternador (dianteiro) / Alternador (delantero) / Alternator (front)				6303 2RS / C3	000625406303	BB
				6303 Z / C3	000625900193	BB
				6303 Z / C3	000625900182	BB
Alternador (traseiro) / Alternador (trasero) / Alternator (rear)				62201 2RS / C3	0029819095	BB
Árvore de manivela / Árbol de levas / Camshaft				6204 2RS / C3	000625406204	BB
Bomba d'água (dianteiro) / Bomba de agua (delantero) / Water pump (front)				6203	000625006203	BB
Bomba d'água (traseiro) / Bomba de agua (trasero) / Water pump (rear)				6206	000625006206	BB
Bomba hidráulica / Bomba hidráulica / Hydraulic pump				62204 2RS	0049819625	BB

	OUT	IN		Fersa®	N° OEM	
---	-----	----	---	---------------	--------	---

MERCEDES BENZ (SA)

608 (L*LO) * 708 (L*LO) * 809 (LO*OF) * 812 (LO*OF) * 814 LO * 817 O * 914 LO * 709 * 710 * 712 * 712 C * 811 * 911 L * 912 * 913 * 914 * 914 C * 917

Motor / Motor / Engine

Bomba injetora (dianteiro) / Bomba inyectora (delantero) / Injection pump (front)				30203 F	000720030203	TRB
Bomba injetora (traseiro) / Bomba inyectora (traseiro) / Injection pump (rear)				30204 F	000720030204	TRB

1018 MBO

Caixa de Mudanças / Caja de Cambios / Gearbox

Eixo de entrada (dianteiro) / Eje de entrada (delantero) / Input shaft (front)			LA * LAK * LAS	30308 F		TRB
Eixo de entrada (traseiro) / Eje de entrada (traseiro) / Input shaft (rear)			LA * LAK * LAS	30309 F		TRB
Eixo intermediário / Eje intermedio / Intermediate shaft				30308 F		TRB
			LA * LAK * LAS	30309 F		TRB
Eixo primário / Eje primario / Primary shaft				QJ 209 FM		BB4PAC
Eixo secundário (traseiro) / Eje secundario (traseiro) / Secondary shaft (rear)				QJ 309 FM		BB4PAC

Cardan / Cardan / Cardan

Suporte / Soporte / Support			L * LK * LS	6208		BB
-----------------------------	--	--	-------------	-------------	--	----

Eixo Dianteiro / Eje Delantero / Front Axle

Roda / Rueda / Wheel		•	L * LK * LS	30312 F		TRB
	•		L * LK * LS	32307 F		TRB
		•	LA * LAK * LAS	497 / 492 A		TRB

Eixo Traseiro / Eje Trasero / Rear Axle

Roda / Rueda / Wheel		•		32216 F		TRB
----------------------	--	---	--	----------------	--	-----

Embreagem / Embrague / Clutch

Apoio / Apoyo / Support				6204		BB
-------------------------	--	--	--	-------------	--	----

Motor / Motor / Engine

Alternador (dianteiro) / Alternador (delantero) / Alternator (front)			69...75	6303 2RS / C3		BB
Alternador (traseiro) / Alternador (traseiro) / Alternator (rear)			69...75	6201 2RS / C3		BB
Bomba d'água - rolam / Bomba de agua - rodam. / Water pump - bearing				30302 F		TRB
Dínamo Bosch (dianteiro) / Dinamo bosch (delantero) / Bosch dynamo (front)			60...74	6303		BB
Dínamo Bosch (traseiro) / Dinamo bosch (traseiro) / Bosch dynamo (rear)			60...74	6203		BB
Ventilador (traseiro) / Ventilador (traseiro) / Fan (rear)				6304		BB
Virabrequim - ponta / Cigüeñal - punta / Crankshaft spindle				6205 2RS		BB

Tomada de Força / Toma de Fuerza / Power Take-off

Eixo de saída (dianteiro) / Eje de salida (delantero) / Output shaft (front)			LK * LAK	6007		BB
Eixo de saída (traseiro) / Eje de salida (traseiro) / Output shaft (rear)			LK * LAK	6206		BB

1111 (L*LA*LAK* LAS*LK*LS)

Caixa de Mudanças / Caja de Cambios / Gearbox

Eixo de entrada (dianteiro) / Eje de entrada (delantero) / Input shaft (front)			LA * LAK * LAS	30308 F		TRB
Eixo de entrada (traseiro) / Eje de entrada (traseiro) / Input shaft (rear)			LA * LAK * LAS	30309 F		TRB

	OUT	IN		Fersa®	Nº OEM	
---	-----	----	---	---------------	--------	---

MERCEDES BENZ (SA)

1111 (L*LA*LAK*LAS*LK*LS)

Caixa de Mudanças / Caja de Cambios / Gearbox

Eixo intermediário / Eje intermedio / Intermediate shaft				30308 F		TRB
			LA * LAK * LAS	30309 F		TRB
Eixo primário / Eje primario / Primary shaft				QJ 209 FM		BB4PAC
Eixo secundário (traseiro) / Eje secundario (trasero) / Secondary shaft (rear)				QJ 309 FM		BB4PAC

Cardan / Cardan / Cardan

Suporte / Soporte / Support			L * LK * LS	6208		BB
-----------------------------	--	--	-------------	-------------	--	----

Eixo Dianteiro / Eje Delantero / Front Axle

Roda / Rueda / Wheel		•	L * LK * LS	30312 F		TRB
	•		L * LK * LS	32307 F		TRB
		•	LA * LAK * LAS	497 / 492 A		TRB

Eixo Traseiro / Eje Trasero / Rear Axle

Roda / Rueda / Wheel		•		32216 F		TRB
----------------------	--	---	--	----------------	--	-----

Embreagem / Embrague / Clutch

Apoio / Apoyo / Support				6204		BB
-------------------------	--	--	--	-------------	--	----

Motor / Motor / Engine

Alternador (dianteiro) / Alternador (delantero) / Alternator (front)			69...75	6303 2RS / C3		BB
Alternador (traseiro) / Alternador (trasero) / Alternator (rear)			69...75	6201 2RS / C3		BB
Bomba d'água - rodam / Bomba de agua - rodam. / Water pump - bearing				30302 F		TRB
Dinamo Bosch (dianteiro) / Dinamo bosch (delantero) / Bosch dynamo (front)			60...74	6303		BB
Dinamo Bosch (traseiro) / Dinamo bosch (trasero) / Bosch dynamo (rear)			60...74	6203		BB
Ventilador (traseiro) / Ventilador (trasero) / Fan (rear)				6304		BB
Virabrequim - ponta / Cigüeñal - punta / Crankshaft spindle				6205 2RS		BB

Tomada de Força / Toma de Fuerza / Power Take-off

Eixo de saída (dianteiro) / Eje de salida (delantero) / Output shaft (front)			LK * LAK	6007		BB
Eixo de saída (traseiro) / Eje de salida (trasero) / Output shaft (rear)			LK * LAK	6206		BB

1113 (L*LA*LAK*LAS*LK*LP*LS*LP) * 1114 * 1114 (L*LK*LP) * 1116 (L*LA*LAK*LAS*LB* LK*LS) * 1118 (L*LK*LP)

Caixa de Mudanças / Caja de Cambios / Gearbox

Eixo de entrada (traseiro) / Eje de entrada (trasero) / Input shaft (rear)			G 3/36-5/8,98 * G 3/40-5/7,5	30309 F		TRB
Eixo intermediário / Eje intermedio / Intermediate shaft				30308 F	0019813105 / 0019815005	TRB
Eixo Intermediário (dianteiro/traseiro) / Eje Intermedio (delantero/trasero) / Intermediate shaft (front/rear)				30309 F	00198113705	TRB
			G 3/36-5/8,98 * G 3/40-5/7,5	30309 F		TRB
Eixo primário (dianteiro) / Eje primario (delantero) / Primary shaft (front)			G 3/36-5/8,98 * G 3/40-5/7,5	QJ 209 FM	3459817027	BB4PAC
			G 3/50-5/8,5 * G 3/60-5/7,5 G 3/50-5/8,5 + NA 3/60-1B * G 3/60-5/7,5 + NA 3/60-1B	QJ 212 FM	3459817627	BB4PAC

	OUT	IN		Fersa®	N° OEM	
---	-----	----	---	---------------	--------	---

MERCEDES BENZ (SA)

1113 (L*LA*LAK*LAS*LK*LP*LS*LP) * 1114 * 1114 (L*LK*LP) * 1116 (L*LA*LAK*LAS*LB* LK*LS) * 1118 (L*LK*LP)

Caixa de Mudanças / Caja de Cambios / Gearbox

Eixo primário (traseiro) / Eje primario (trasero) / Primary shaft (rear)			G 3/50-5/8 * G 3/60-5/7,5 G 3/50-5/8,5 + NA 3/60-1B * G 3/60-5/7,5 + NA 3/60-1B	F 19011		CRBS
				NU 209 FMN	3449817101	CRB
Eixo primário inf. (dianteiro/traseiro) / Eje primario inf. (delantero/trasero) / Primary shaft (front/rear)				6308 ZNR / C3	3129811325	BB
Eixo primário inf. (traseiro) / Eje primario inf. (trasero) / Primary shaft (rear)				NJ 2211 FM	000628000339	CRB
Eixo primário sup. (dianteiro/traseiro) / Eje primario sup. (delantero/trasero) / Upper primary shaft (front/rear)				30308 F	0019813105 / 0019815005	TRB
Eixo secundário (dianteiro) / Eje secundario (delantero) / Secondary shaft (front)				QJ 309 FM	3459817127 / 3459817727	BB4PAC

Eixo Traseiro / Eje Trasero / Rear Axle

Diferencial - coroa lateral (dir./esq.) / Diferencial - corona lateral (der./izq.) / Differential - crown gear (right/left)			HL 4/25 D-7,6/40:7 * HL 4/25 D-7,6/43:7 * HL 4/25 D-7,6/48:7 * HL 4/7,6/48:7 * HL 4/26 D-8,8/43:7	47487 / 47420 A		TRB
Diferencial - pinhão - apoio / Diferencial - piñón - apoyo / Differential - pinion support			733004	33111 F		TRB

Direção / Dirección / Steering

Direção hidráulica - alav.interna (inf.) / Dirección hidráulica - palanca interna (inf.) / Hydraulic direction - inner lever (lower)			LS	30205 F	000720030205	TRB
Direção hidráulica - alav.interna (sup.) / Dirección hidráulica - palanca interna (sup.) / Hydraulic direction - inner lever (upper)			LS	30206 F	000720030206	TRB

Eixo Dianteiro / Eje Delantero / Front Axle

Roda / Rueda / Wheel		•		30312 F	0019819705	TRB
			VL 2/13 C-2.9 1114	32306 F		TRB
		•		32307 F	0039816405	TRB
			VL 2/13 C-2.9 1114	33111 F		TRB
		•		33208 F	3849817605 / 0089810105	TRB
		•		33213 F	0089810005	TRB
		•		497 / 492 A	0009816105	TRB

Eixo Traseiro / Eje Trasero / Rear Axle



Roda / Rueda / Wheel		•		32216 F	0009817205	TRB
		•		33019 F	00298190 (77...)/ 0039818605	TRB
		•		33215 F	0029818905 / 0029818605	TRB

Embreagem / Embrague / Clutch

Apoyo / Apoyo / Support				6204	000625006204	
-------------------------	--	--	--	------	--------------	--

Motor / Motor / Engine

Alternador (dianteiro) / Alternador (delantero) / Alternator (front)			OM 366 * 352 * M 352 O	6303 2RS / C3		BB
				6403 2RS / C3	0049812425	BB
Alternador (traseiro) / Alternador (trasero) / Alternator (rear)			M 352 O * OM 352	6201 Z / C3		BB
			OM 366 * OM 352 * OM 364 LA	62201 2RS / C3		BB
Bomba d'água / Bomba de agua / Water pump				30302 F	000720030202	TRB

	OUT	IN		Fersa®	N° OEM	
---	-----	----	---	---------------	--------	---

MERCEDES BENZ (SA)

1113 (L*LA*LAK*LAS*LK*LP*LS*LP) * 1114 * 1114 (L*LK*LP) * 1116 (L*LA*LAK*LAS*LB* LK*LS) * 1118 (L*LK*LP)

Embreagem / Embrague / Clutch

Bomba d'água (dianteiro) / Bomba de agua (delantero) / Water pump (front)				6203 C3	000625900208	BB
			OM 366 * OM 364 LA	6206 C3		BB
Bomba d'água (traseiro) / Bomba de agua (trasero) / Water pump (rear)			OM 366 * OM 364 LA	6203 C3		BB
				6206 C3	000625006206	BB
Bomba hidráulica / Bomba hidráulica / Hydraulic pump				62204 2RS	0049819625	BB
Bomba injetora (dianteiro) / Bomba inyectora (delantero) / Injection pump (front)				30203 F	000720030203	TRB
Bomba servo (dianteira) / Bomba servo (delantero) / Servopump (front)			OM 364 LA	62204 2RS		BB
Virabrequim / Cigüeñal / Crankshaft				6204 2RS / C3	000625406204	BB
Ventilador - comando da ventoinha (esq.) / Ventilador - control del ventilador (izd.) / Fan fan control (left)			OH 1115 L	6304 C3		BB
Virabrequim - ponta / Cigüeñal - punta / Crankshaft spindle			OM 366 * OM 352/A/AI * M352 O	6204 2RS		BB

Tomada de Força / Toma de Fuerza / Power Take-off

Eixo de saída (traseiro) / Eje de salida (trasero) / Output shaft (rear)			G 3/60-5/7,5 + NA 3/60-1B G 3/50-5/7,5 + NA 3/60-1B	6007 N		BB
--	--	--	---	---------------	--	----

Tomada de Potência / Toma de Potencia / Power Take-off

Eixo primário (dianteiro) / Eje primario (delantero) / Primary shaft (front)				6206	000625006006	BB
Eixo primário (traseiro) / Eje primario (trasero) / Primary shaft (rear)				6007 N	000625506007	BB

1113 OF * 1115 OF

Caixa de Mudanças / Caja de Cambios / Gearbox

Eixo de entrada (traseiro) / Eje de entrada (trasero) / Input shaft (rear)			G 3/36-5/8,98 * G 3/40-5/7,5	30309 F		TRB
Eixo intermediário / Eje intermedio / Intermediate shaft				30308 F	0019813105 / 0019815005	TRB
Eixo Intermediário (dianteiro/traseiro) / Eje Intermedio (delantero/trasero) / Intermediate shaft (front/rear)			G 3/36-5/8,98 * G 3/40-5/7,5	30309 F	00198113705	TRB
				30309 F		TRB
Eixo primário (dianteiro) / Eje primario (delantero) / Primary shaft (front)			G 3/36-5/8,98 * G 3/40-5/7,5	QJ 209 FM	3459817027	BB4PAC
			G 3/50-5/8,5 * G 3/60-5/7,5 G 3/50-5/8,5 + NA 3/60-1B * G 3/60-5/7,5 + NA 3/60-1B	QJ 212 FM	3459817627	BB4PAC
Eixo primário (traseiro) / Eje primario (trasero) / Primary shaft (rear)			G 3/50-5/8 * G 3/60-5/7,5 G 3/50-5/8,5 + NA 3/60-1B * G 3/60-5/7,5 + NA 3/60-1B	F 19011		CRBS
				NU 209 FMN	3449817101	CRB
Eixo primário inf. (dianteiro/traseiro) / Eje primario inf. (delantero/trasero) / Primary shaft (front/rear)				6308 ZNR / C3	3129811325	BB
Eixo primário inf. (traseiro) / Eje primario inf. (trasero) / Primary shaft (rear)				NJ 2211 FM	000628000339	CRB
Eixo primário sup. (dianteiro/traseiro) / Eje primario sup. (delantero/trasero) / Upper primary shaft (front/rear)				30308 F	0019813105 / 0019815005	TRB
Eixo secundário (dianteiro) / Eje secundario (delantero) / Secondary shaft (front)				QJ 309 FM	3459817127 / 3459817727	BB4PAC

	OUT	IN		Fersa®	N° OEM	
---	-----	----	---	---------------	--------	---

MERCEDES BENZ (SA)

1113 OF * 1115 OF

Eixo Traseiro / Eje Trasero / Rear Axle

Diferencial - coroa lateral (dir./esq.) / Diferencial - corona lateral (der./izq.) / Differential - crown gear (right/left)			HL 4/25 D-7,6/40:7 * HL 4/25 D-7,6/43:7 * HL 4/25 D-7,6/48:7 * HL 4/7,6/48:7 * HL 4/26 D-8,8/43:7	47487 / 47420 A		TRB
Diferencial - pinhão - apoio / Diferencial - piñón - apoyo / Differential - pinion support			733004	33111 F		TRB

Direção / Dirección / Steering

Direção hidráulica - alav.interna (inf.) / Dirección hidráulica - palanca interna (inf.) / Hydraulic direction - inner lever (lower)			LS	30205 F	000720030205	TRB
Direção hidráulica - alav.interna (sup.) / Dirección hidráulica - palanca interna (sup.) / Hydraulic direction - inner lever (upper)			LS	30206 F	000720030206	TRB

Eixo Dianteiro / Eje Delantero / Front Axle

Roda / Rueda / Wheel		•		30312 F	0019819705	TRB
			VL 2/13 C-2.9 1114	32306 F		TRB
		•		32307 F	0039816405	TRB
			VL 2/13 C-2.9 1114	33111 F		TRB
		•		33208 F	3849817605 / 0089810105	TRB
			•	33213 F	0089810005	TRB
		•		497 / 492 A	0009816105	TRB

Eixo Traseiro / Eje Trasero / Rear Axle

Roda / Rueda / Wheel		•		32216 F	0009817205	TRB
		•		33019 F	00298190 (77...)05 / 0039818605	TRB
		•		33215 F	0029818905 / 0029818605	TRB

Embreagem / Embrague / Clutch

Apoio / Apoyo / Support				6204	000625006204	BB
-------------------------	--	--	--	-------------	--------------	----

Motor / Motor / Engine

Alternador (dianteiro) / Alternador (delantero) / Alternator (front)			OM 366 * 352 * M 352 O	6303 2RS / C3		BB
				6403 2RS / C3	0049812425	BB
Alternador (traseiro) / Alternador (trasero) / Alternator (rear)			M 352 O * OM 352	6201 Z / C3		BB
			OM 366, OM 352 * OM 364 LA	62201 2RS / C3		BB
Bomba d'água / Bomba de agua / Water pump				30302 F	000720030202	TRB
Bomba d'água (dianteiro) / Bomba de agua (delantero) / Water pump (front)				6203 C3	000625900208	BB
			OM 366 * OM 364 LA	6206 C3		BB
Bomba d'água (traseiro) / Bomba de agua (trasero) / Water pump (rear)			OM 366 * OM 364 LA	6203 C3		BB
				6206 C3	000625006206	BB
Bomba hidráulica / Bomba hidráulica / Hydraulic pump				62204 2RS	0049819625	BB
Bomba injetora (dianteiro) / Bomba inyectora (delantero) / Injection pump (front)				30203 F	000720030203	TRB
Bomba servo (dianteira) / Bomba servo (delantero) / Servopump (front)			OM 364 LA	62204 2RS		BB
Virabrequim / Cigüeñal / Crankshaft				6204 2RS / C3	000625406204	BB

	OUT	IN		Fersa®	Nº OEM	
---	-----	----	---	---------------	--------	---

MERCEDES BENZ (SA)

1113 OF * 1115 OF

Motor / Motor / Engine

Ventilador - comando da ventoinha (esq.) / Ventilador - control del ventilador (izd.) / Fan fan control (left)			OH 1115 L	6304 C3		BB
Virabrequim - ponta / Cigüeñal - punta / Crankshaft spindle			OM 366 * OM 352/A/AI * M352 O * OM 364 LA	6204 2RS		BB

Tomada de Força / Toma de Fuerza / Power Take-off

Eixo de saída (traseiro) / Eje de salida (trasero) / Output shaft (rear)			G 3/60-5/7,5 + NA 3/60-1B G 3/50-5/7,5 + NA 3/60-1B	6007 N		BB
--	--	--	---	---------------	--	----

Tomada de Potência / Toma de Potencia / Power Take-off

Eixo primário (dianteiro) / Eje primario (delantero) / Primary shaft (front)				6206	000625006006	BB
Eixo primário (traseiro) / Eje primario (trasero) / Primary shaft (rear)				6007 N	000625506007	BB

1214 C * 1214 K * 1214 (L*LK*LS) * 1215 * 1215 C * 1215 (L*LA*LK) * 1218 * 1218 R (L)

Caixa de Mudanças / Caja de Cambios / Gearbox

Eixo de acionamento / Eje de accionamiento / Drive shaft				NUP 2212 FMN		CRB
Eixo de entrada (dianteiro) / Eje de entrada (delantero) / Input shaft (front)			ZG 500-3 M/1,64 * VG 500-3 W/1,64	33210 F		TRB
Eixo Intermediário (dianteiro/traseiro) / Eje Intermedio (delantero/trasero) / Intermediate shaft (front/rear)				32208 F	A0159813405	TRB
Eixo intermediário (entrada) / Eje intermedio (entrada) / Intermediate shaft (input)				3382 / 3320		TRB
Eixo intermediário (saída) / Eje intermedio (salida) / Intermediate shaft (output)				2789 / 2720		TRB
Eixo primário (dianteiro) / Eje primario (delantero) / Primary shaft (front)				QJ 212 FM	3459817627	BB4PAC
Eixo primário (traseiro) / Eje primario (trasero) / Primary shaft (rear)			(L 1215) * G 3/60-5/7,5 * G 3/50-5/8,5 * G 3/50-5/8,5 + NA 3/60-1B	F 19011		CRBS
Eixo principal (entrada / saída) / Eje principal (entrada / salida) / Main shaft (input / output)				32210 F	A0159815005	TRB
Eixo principal (saída) / Eje principal (salida) / Main shaft (output)				NUP 310 FMN / C3		CRB
Eixo secundário / Eje secundario / Secondary shaft			G 3/55-6/8,5 * G 3/55-6/8,5 + NA 3/60-1B	F 19046		CRBS
Eixo secundário (dianteiro) / Eje secundario (delantero) / Secondary shaft (front)				QJ 309 FM	3459817127 / 3459817727	BB4PAC
Eixo secundário (traseiro) / Eje secundario (trasero) / Secondary shaft (rear)			L 1215 * G 3/60-5/7,5 * G 3/50-5/8,5 * G 3/50-5/8,5 + NA 3/60-1B G 3/60-5/7,5 + NA 3/60-1B	QJ 309 FM		BB4PAC
Tomada de força / Toma de fuerza / Power take-off				6208 N		BB

Eixo Traseiro / Eje Trasero / Rear Axle

Diferencial - coroa lateral (dir./esq.) / Diferencial - corona lateral (der./izq.) / Differential - crown gear (right/left)			HL 4/60 D-10	32018 XF		TRB
			HL 5/60 DZ-10 * HL 5/60 DZ-10/39:8	32020 XF		TRB
			HL 4/25 D-7,6/43:7 * HL 4/25 D-7,6/40:7 * HL 4/25 D-7,6/42:8 * HL 4/25 D-7,6/39:8 * HL 4/60 D-10/40:7 * HL 4/60 10/42:8 *	47487 / 47420 A		TRB
Diferencial - coroa lateral (dir.) / Diferencial - corona lateral (der.) / Differential - crown gear (right)			AL 4/5 D 4,3 48:7	47487 / 47420 A		TRB
Diferencial - pinhão (traseiro) / Diferencial - piñón (trasero) / Differential - pinion (rear)			HL 5/60 DZ-10 * HL 5/60 DZ-10/39:8	F 15083		STRB

	OUT	IN		Fersa®	N° OEM	
---	-----	----	---	---------------	--------	---

MERCEDES BENZ (SA)

1214 C * 1214 K * 1214 (L*LK*LS) * 1215 * 1215 C * 1215 (L*LA*LK) * 1218 * 1218 R (L)

Eixo Dianteiro / Eje Delantero / Front Axle

Roda / Rueda / Wheel	•			33208 F	3849817605 / 0089810105	TRB
		•		33213 F	0089810005	TRB
		•	AL 4/5 D 4,3 48:7	497 / 492 A		TRB

Eixo Traseiro / Eje Trasero / Rear Axle

Roda / Rueda / Wheel				32214 F	001 981 8005	TRB
		•		32216 F	0009817205	TRB
		•		33019 F	00298190 (77...)05 / 0039818605	TRB
	•			33020 F	0059818505	TRB
		•		33117 F	0059818605	TRB
	•			33215 F	0029818905	TRB

Motor / Motor / Engine

Alternador (dianteiro) / Alternador (delantero) / Alternator (front)				6403 2RS / C3	0049812425	BB
Alternador (traseiro) / Alternador (trasero) / Alternator (rear)				62201 2RS / C3	00298190 (77...)95	BB
Bomba d'água (dianteiro) / Bomba de agua (delantero) / Water pump (front)				6206 C3	000625900209	BB
Bomba d'água (traseiro) / Bomba de agua (trasero) / Water pump (rear)				6203 C3	000625900208	BB
Bomba hidráulica / Bomba hidráulica / Hydraulic pump				62204 2RS	0049819625	BB
Bomba injetora (dianteiro) / Bomba inyectora (delantero) / Injection pump (front)				30203 F	000720030203	TRB
Bomba injetora (traseiro) / Bomba inyectora (trasero) / Injection pump (rear)				30204 F	000720030204	TRB
Bomba servo (dianteira) / Bomba servo (delantero) / Servopump (front)			OM 366	62204 2RS		BB
Virabrequim / Cigüeñal / Crankshaft				6204 2RS / C3	000625406204	BB
Virabrequim - ponta / Cigüeñal - punta / Crankshaft spindle			OM 366 * OM 366 A * L 1215 * OM 364 LA * 1214 K	6204 2RS		BB

Tomada de Força / Toma de Fuerza / Power Take-off

Eixo de saída (traseiro) / Eje de salida (trasero) / Output shaft (rear)			G 3/60-5/7,5 + NA 3/60-1B * G 3/50-5/8,5 + NA 3/60-1B	6007 N		BB
--	--	--	---	---------------	--	----

Tomada de Potência / Toma de Potencia / Power Take-off

Eixo primário (dianteiro) / Eje primario (delantero) / Primary shaft (front)				6007 N	000625506007	BB
--	--	--	--	---------------	--------------	----

1215 (OF) * 1217 (OF)

Caixa de Mudanças / Caja de Cambios / Gearbox

Eixo de acionamento / Eje de accionamiento / Drive shaft				NUP 2212 FMN		CRB
Eixo de entrada (dianteiro) / Eje de entrada (delantero) / Input shaft (front)			ZG 500-3 M/1,64 * VG 500-3 W/1,64	33210 F		TRB
Eixo Intermediário (dianteiro/traseiro) / Eje Intermedio (delantero/trasero) / Intermediate shaft (front/rear)				32208 F	A0159813405	TRB
Eixo intermediário (entrada) / Eje intermedio (entrada) / Intermediate shaft (input)				3382 / 3320		TRB
Eixo intermediário (saída) / Eje intermedio (salida) / Intermediate shaft (output)				2789 / 2720		TRB
Eixo primário (dianteiro) / Eje primario (delantero) / Primary shaft (front)				QJ 212 FM	3459817627	BB4PAC

	OUT	IN		Fersa®	Nº OEM	
---	-----	----	---	---------------	--------	---

MERCEDES BENZ (SA)

1215 (OF) * 1217 (OF)

Caixa de Mudanças / Caja de Cambios / Gearbox

Eixo primário (traseiro) / Eje primario (trasero) / Primary shaft (rear)			(L 1215) * G 3/60-5/7,5 * G 3/50-5/8,5 * G 3/50-5/8,5 + NA 3/60-1B	F 19011		CRBS
Eixo principal (entrada / saída) / Eje principal (entrada / salida) / Main shaft (input / output)				32210 F	A0159815005	TRB
Eixo principal (saída) / Eje principal (salida) / Main shaft (output)				NUP 310 FMN / C3		CRB
Eixo secundário / Eje secundario / Secondary shaft			G 3/55-6/8,5 * G 3/55-6/8,5 + NA 3/60-1B	F 19046		CRBS
Eixo secundário (dianteiro) / Eje secundario (delantero) / Secondary shaft (front)				QJ 309 FM	3459817127 / 3459817727	BB4PAC
Eixo secundário (traseiro) / Eje secundario (trasero) / Secondary shaft (rear)			(L 1215) * G 3/60-5/7,5 * G 3/50-5/8,5 * G 3/50-5/8,5 + NA 3/60-1B G 3/60-5/7,5 + NA 3/60-1B	QJ 309 FM		BB4PAC
Tomada de força / Toma de fuerza / Power take-off				6208 N		BB

Eixo Traseiro / Eje Trasero / Rear Axle

Diferencial - coroa lateral (dir./esq.) / Diferencial - corona lateral (der./izq.) / Differential - crown gear (right/left)			HL 4/60 D-10	32018 XF		TRB
			HL 5/60 DZ-10 * HL 5/60 DZ-10/39:8	32020 XF		TRB
			HL 4/25 D-7,6/43:7 * HL 4/25 D-7,6/40:7 * HL 4/25 D-7,6/42:8 * HL 4/25 D-7,6/39:8 * HL 4/60 D-10/40:7 * HL 4/60 10/42:8 *	47487 / 47420 A		TRB
Diferencial - coroa lateral (dir.) / Diferencial - corona lateral (der.) / Differential - crown gear (right)			AL 4/5 D 4,3 48:7	47487 / 47420 A		TRB
Diferencial - pinhão (traseiro) / Diferencial - piñón (trasero) / Differential - pinion (rear)			HL 5/60 DZ-10 * HL 5/60 DZ-10/39:8	F 15083		STRB

Eixo Dianteiro / Eje Delantero / Front Axle

Roda / Rueda / Wheel	•			33208 F	3849817605 / 0089810105	TRB
		•		33213 F	0089810005	TRB
		•	AL 4/5 D 4,3 48:7	497 / 492 A		TRB

Eixo Traseiro / Eje Trasero / Rear Axle

Roda / Rueda / Wheel				32214 F	001 981 8005	TRB
		•		32216 F	0009817205	TRB
		•		33019 F	00298190 (77...)05 / 0039818605	TRB
	•			33020 F	0059818505	TRB
		•		33117 F	0059818605	TRB
	•			33215 F	0029818905	TRB

Motor / Motor / Engine

Alternador (dianteiro) / Alternador (delantero) / Alternator (front)				6403 2RS / C3	0049812425	BB
Alternador (traseiro) / Alternador (trasero) / Alternator (rear)				62201 2RS / C3	00298190 (77...)95	BB
Bomba d'água (dianteiro) / Bomba de agua (delantero) / Water pump (front)				6206 C3	000625900209	BB
Bomba d'água (traseiro) / Bomba de agua (trasero) / Water pump (rear)				6203 C3	000625900208	BB
Bomba hidráulica / Bomba hidráulica / Hydraulic pump				62204 2RS	0049819625	BB

	OUT	IN		Fersa®	N° OEM	
---	-----	----	---	---------------	--------	---

MERCEDES BENZ (SA)

1215 (OF) * 1217 (OF)

Motor / Motor / Engine

Bomba injetora (dianteiro) / Bomba inyectora (delantero) / Injection pump (front)				30203 F	000720030203	TRB
Bomba injetora (traseiro) / Bomba inyectora (trasero) / Injection pump (rear)				30204 F	000720030204	TRB
Bomba servo (dianteira) / Bomba servo (delantero) / Servopump (front)			OM 366	62204 2RS		BB
Virabrequim / Cigüeñal / Crankshaft				6204 2RS / C3	000625406204	BB
Virabrequim - ponta / Cigüeñal - punta / Crankshaft spindle			OM 366 * OM 366 A * L 1215 * OM 364 LA * 1214 K	6204 2RS		BB

Tomada de Força / Toma de Fuerza / Power Take-off

Eixo de saída (traseiro) / Eje de salida (trasero) / Output shaft (rear)			G 3/60-5/7,5 + NA 3/60-1B * G 3/50-5/8,5 + NA 3/60-1B	6007 N		BB
--	--	--	--	---------------	--	----

Tomada de Potência / Toma de Potencia / Power Take-off

Eixo primário (dianteiro) / Eje primario (delantero) / Primary shaft (front)				6007 N	000625506007	BB
--	--	--	--	---------------	--------------	----

1313 (L*LA*LAK*LB*LK*LS) * 1314 (L*LA*LAK*LB*LK*LS) * 1316 (L*LA*LAK*LAS*LB*LK*LS) * 1317 (L*LA*LAK*LK*LS) * 1319 (L)

Caixa de Mudanças / Caja de Cambios / Gearbox

Eixo de entrada (traseiro) / Eje de entrada (trasero) / Input shaft (rear)			ZG 500-3 M/1,64 * VG 500-3 W/1,64	33209 F		TRB
Eixo de saída (dianteiro/traseiro) / Eje de salida (delantero/trasero) / Output shaft (front/rear)			ZG 500-3 M/1,64 * VG 500-3 W/1,64	33011 F		TRB
			ZG 500-3 M/1,64 * VG 500-3 W/1,64	33113 F		TRB
			ZG 500-3 M/1,64 * VG 500-3 W/1,64	6211 N / C3		BB
Eixo intermediário (dianteiro) / Eje intermedio (delantero) / Intermediate shaft (front)				33210 F	0039818305	TRB
Eixo Intermediário (dianteiro/traseiro) / Eje Intermedio (delantero/trasero) / Intermediate shaft (front/rear)				30309 F	00198113705	TRB
			G 3/40-5/7,5 * G 3/36-5/8,98 G 3/60-5/7,5 + NA 3/60-1B * G 3/60-5/8,5 + NA 3/60-1B	30308 F	0019813105 / 0019815005	TRB
Eixo intermediário (traseiro) / Eje intermedio (trasero) / Intermediate shaft (rear)				33212 F	0059812805	TRB
Eixo primário (dianteiro) / Eje primario (delantero) / Primary shaft (front)				QJ 212 FM	3459817627	BB4PAC
Eixo primário (traseiro) / Eje primario (trasero) / Primary shaft (rear)			G 3/60-5/7,5 + NA 3/60-1B G 3/60-5/8,5 + NA 3/60-1B * G 3/60-5/7,5	F 19011		CRBS
Eixo primário inf. (dianteiro/traseiro) / Eje primario inf. (delantero/trasero) / Primary shaft - lower (front/rear)				6308 ZNR / C3	3129811325	BB
				6211 N / C3	0019819125	BB
				33112 F		TRB
				33011 F	0029819305	TRB
				NJ 2211 FM	000628000339	CRB
Eixo primário sup. (dianteiro) / Eje primario sup. (delantero) / Upper primary shaft (front)				30309 F	00198113705	TRB
				33210 F	0039818305	TRB
Eixo primário sup. (traseiro) / Eje primario sup. (trasero) / Upper primary shaft (rear)				30308 F	0019813105 / 0019815005	TRB
				33209 F	0039815705	TRB

	OUT	IN		Fersa®	Nº OEM	
---	-----	----	---	---------------	--------	---

MERCEDES BENZ (SA)

1313 (L*LA*LAK*LB*LK*LS) * 1314 (L*LA*LAK*LB*LK*LS) * 1316 (L*LA*LAK*LAS*LB*LK*LS) * 1317 (L*LA*LAK*LK*LS) * 1319 (L)

Caixa de Mudanças / Caja de Cambios / Gearbox

Eixo secundário (traseiro) / Eje secundario (trasero) / Secondary shaft (rear)				QJ 309 FM	3459817127 / 3459817727	BB4PAC
--	--	--	--	------------------	-------------------------	--------

Eixo Traseiro / Eje Trasero / Rear Axle

Diferencial - coroa lateral (dir./esq.) / Diferencial - corona lateral (der./izq.) / Differential - crown gear (right/left)			HH O5 D-10/43:10	32018 XF		TRB
			745004/007/012/033/035/036	32020 XF		TRB
			HH 4/12 D-10/40:7 * HL 4/26 D-9,2/48:7 * HL 4/26 D-9,2/43:7 * HL 4/14-8,8/43:7 * HL 4/27 D-10/43:7	47487 / 47420 A		TRB
Diferencial - pinhão (traseiro) / Diferencial - piñón (trasero) / Differential - pinion (rear)			745004/007/012/033/035/036	F 15083		STRB
				F 15083	003981190 (77...)/5	STRB
Diferencial - pinhão (dianteiro) / Diferencial - piñón (delantero) / Differential - pinion (front)				F 15183	0069811705	TRBS

Eixo Dianteiro / Eje Delantero / Front Axle

Roda / Rueda / Wheel	•		AL 4/50-4,3/48:7	30214 F		TRB
	•			32307 F	0039816405	TRB
	•			33208 F	3849817605 / 0089810105	TRB
	•			33209 F	0039815705	TRB
	•		VL 3/7 D-5	33213 F	0089810005	TRB
	•		VL 3/7 D-5	33214 F		TRB
	•			33214 F	0039815605 / 0039815205	TRB
	•		AL 4/50-4,3/48:7	497 / 492 A	0009816105	TRB

Eixo Traseiro / Eje Trasero / Rear Axle

Roda / Rueda / Wheel		•		33019 F	00298190 (77...)/05 / 0039818605	TRB
		•		33020 F	0059818505	TRB
		•		33117 F	0059818605	TRB
		•		33215 F	0029818905 / 0029818605	TRB
		•		598 A / 593 X	0039811405	TRB

Embreagem / Embrague / Clutch

Desengate / Desembrague / Clutch				6204 2RS	000625406104	BB
----------------------------------	--	--	--	-----------------	--------------	----

Motor / Motor / Engine

Alternador (dianteiro) / Alternador (delantero) / Alternator (front)			OM 366 A/G * OM 366 * OM 352 I	6303 2RS / C3	000625406303	BB
Alternador (dianteiro) / Alternador (delantero) / Alternator (front)				6403 2RS / C3		BB
Alternador (traseiro) / Alternador (trasero) / Alternator (rear)				6201 2RS / C3	0049812425	BB
				62201 2RS / C3	000625406303	BB
Bomba d'água (dianteiro) / Bomba de agua (delantero) / Water pump (front)			OM 352 * OM 352 A * OM 352 I	6203 C3		BB
				6206 C3	000625900209	BB
Bomba d'água (dianteiro/traseiro) / Bomba de agua (delantero/trasero) / Water pump (front/rear)				6203 C3	000625900208	BB
Bomba d'água (traseiro) / Bomba de agua (trasero) / Water pump (rear)			OM 366 * OM 366 A * OM 366 G * OM 366 LA	6203 C3		BB
			OM 352 * OM 352 A * OM 352 I	6206 C3		BB

	OUT	IN		Fersa®	N° OEM	
---	-----	----	---	---------------	--------	---

MERCEDES BENZ (SA)

1313 (L*LA*LAK*LB*LK*LS) * 1314 (L*LA*LAK*LB*LK*LS) * 1316 (L*LA*LAK*LAS*LB*LK*LS) * 1317 (L*LA*LAK*LK*LS) * 1319 (L)

Motor / Motor / Engine

Bomba hidráulica / Bomba hidráulica / Hydraulic pump				62204 2RS	0049819625	BB
Bomba injetora (dianteiro) / Bomba inyectora (delantero) / Injection pump (front)				30203 F	000720030203	TRB
				30205 F	000720030205	TRB
Bomba injetora (traseiro) / Bomba inyectora (traseiro) / Injection pump (rear)				30204 F	000720030204	TRB
			OM 366	30205 F		TRB
			OM 366 LA	30206 F		TRB
Virabrequim / Cigüeñal / Crankshaft				6204 2RS / C3	000625406204	BB
Polia tensora / Polea tensora / Tensioner pulley				6303	000635006303	BB
Ventilador (traseiro) / Ventilador (traseiro) / Fan (rear)				6304 C3	000635006303	BB
Virabrequim - ponta / Cigüeñal - punta / Crankshaft spindle			OM 366/A * OM 352/A/I * OM 366 G * OM 366 LA	6204 2RS		BB

Tomada de Força / Toma de Fuerza / Power Take-off

Eixo de saída (traseiro) / Eje de salida (traseiro) / Output shaft (rear)			G 3/60-5/7,5 + NA 3/60-1B * G 3/60-5/8,5 + NA 3/60-1B	6007 N		BB
---	--	--	--	---------------	--	----



Tomada de Potência / Toma de Potencia / Power Take-off

Eixo primário (traseiro) / Eje primario (traseiro) / Primary shaft (rear)				6007 N	000625506007	BB
---	--	--	--	---------------	--------------	----

1313 OF * 1314 OF * 1315 OF * 1316 OF * 1317 OF * 1318 OF * 1319 OF * 1320 OF

Caixa de Mudanças / Caja de Cambios / Gearbox

Eixo de entrada (traseiro) / Eje de entrada (traseiro) / Input shaft (rear)			ZG 500-3 M/1,64 * VG 500-3 W/1,64	33209 F		TRB
Eixo de saída (dianteiro/traseiro) / Eje de salida (delantero/traseiro) / Output shaft (front)			ZG 500-3 M/1,64 * VG 500-3 W/1,64	33011 F		TRB
			ZG 500-3 M/1,64 * VG 500-3 W/1,64	33113 F		TRB
			ZG 500-3 M/1,64 * VG 500-3 W/1,64	6211 N / C3		BB
Eixo intermediário (dianteiro) / Eje intermedio (delantero) / Intermediate shaft (front)				33210 F	0039818305	TRB
Eixo Intermediário (dianteiro/traseiro) / Eje Intermedio (delantero/traseiro) / Intermediate shaft (front/rear)				30309 F	00198113705	TRB
			G 3/40-5/7,5 * G 3/36-5/8,98 G 3/60-5/7,5 + NA 3/60-1B * G 3/60-5/8,5 + NA 3/60-1B	30308 F	0019813105 / 0019815005	TRB
Eixo intermediário (traseiro) / Eje intermedio (traseiro) / Intermediate shaft (rear)				33212 F	0059812805	TRB
Eixo primário (dianteiro) / Eje primario (delantero) / Primary shaft (front)				QJ 212 FM	3459817627	BB4PAC
Eixo primário (traseiro) / Eje primario (traseiro) / Primary shaft (rear)			G 3/60-5/7,5 + NA 3/60-1B G 3/60-5/8,5 + NA 3/60-1B * G 3/60-5/7,5	F 19011		CRBS
				6308 ZNR / C3	3129811325	BB
Eixo primário inf. (dianteiro/traseiro) / Eje primario inf. (delantero/traseiro) / Primary shaft - lower (front/rear)				6211 N / C3	0019819125	BB
				33112 F		TRB
				33011 F	0029819305	TRB
				NJ 2211 FM	000628000339	CRB
Eixo primário sup. (dianteiro) / Eje primario sup. (delantero) / Upper primary shaft (front)				30309 F	00198113705	TRB
				33210 F	0039818305	TRB
Eixo primário sup. (traseiro) / Eje primario sup. (traseiro) / Upper primary shaft (rear)				30308 F	0019813105 / 0019815005	TRB
				33209 F	0039815705	TRB

	OUT	IN		Fersa®	Nº OEM	
---	-----	----	---	---------------	--------	---

MERCEDES BENZ (SA)

1313 OF * 1314 OF * 1315 OF * 1316 OF * 1317 OF * 1318 OF * 1319 OF * 1320 OF

Caixa de Mudanças / Caja de Cambios / Gearbox

Eixo secundário (traseiro) / Eje secundario (trasero) / Secondary shaft (rear)				QJ 309 FM	3459817127 / 3459817727	BB4PAC
---	--	--	--	------------------	----------------------------	--------

Eixo Traseiro / Eje Trasero / Rear Axle

Diferencial - coroa lateral (dir./esq.) / Diferencial - corona lateral (der./izq.) / Differential - crown gear (right/left)			HH O5 D-10/43:10	32018 XF		TRB
			745004/007/012/ 033/035/036	32020 XF		TRB
			HH 4/12 D-10/40:7 * HL 4/26 D-9,2/48:7 * HL 4/26 D-9,2/43:7 * HL 4/14-8,8/43:7 * HL 4/27 D-10/43:7	47487 / 47420 A		TRB
Diferencial - pinhão (traseiro) / Diferencial - piñón (trasero) / Differential - pinion (rear)			745004/007/012/ 033/035/036	F 15083		STRB
				F 15083	0069811705	STRB

Eixo Dianteiro / Eje Delantero / Front Axle

Roda / Rueda / Wheel	•		AL 4/50-4,3/48:7	30214 F		TRB
	•			32307 F	0039816405	TRB
	•			33208 F	3849817605 / 0089810105	TRB
	•			33209 F	0039815705	TRB
	•		VL 3/7 D-5	33213 F	0089810005	TRB
	•		VL 3/7 D-5	33214 F		TRB
	•			33214 F	0039815605 / 0039815205	TRB
	•		AL 4/50-4,3/48:7	497 / 492 A	0009816105	TRB

Eixo Traseiro / Eje Trasero / Rear Axle

Roda / Rueda / Wheel		•		33019 F	00298190 (77...)/05 / 0039818605	TRB
		•		33020 F	0059818505	TRB
	•			33117 F	0059818605	TRB
	•			33215 F	0029818905 / 0029818605	TRB
		•		598 A / 593 X	0039811405	TRB

Embreagem / Embrague / Clutch

Desengate / Desembrague / Clutch				6204 2RS	000625406104	BB
----------------------------------	--	--	--	-----------------	--------------	----

Motor / Motor / Engine

Alternador (dianteiro) / Alternador (delantero) / Alternator (front)			OM 366 A/G * OM 366 * OM 352 I	6303 2RS / C3	000625406303	BB
Alternador (dianteiro) / Alternador (delantero) / Alternator (front)				6403 2RS / C3		BB
Alternador (traseiro) / Alternador (trasero) / Alternator (rear)				6201 2RS / C3	0049812425	BB
				62201 2RS / C3	000625406303	BB
Bomba d'água (dianteiro) / Bomba de agua (delantero) / Water pump (front)			OM 352 * OM 352 A * OM 352 I	6203 C3		BB
				6206 C3	000625900209	BB
Bomba d'água (dianteiro/traseiro) / Bomba de agua (delantero/trasero) / Water pump (front/rear)				6203 C3	000625900208	BB
Bomba d'água (traseiro) / Bomba de agua (trasero) / Water pump (rear)			OM 366 * OM 366 A * OM 366 G * OM 366 LA	6203 C3		BB
			OM 352 * OM 352 A * OM 352 I	6206 C3		BB

	OUT	IN		Fersa®	N° OEM	
---	-----	----	---	---------------	--------	---

MERCEDES BENZ (SA)

1313 OF * 1314 OF * 1315 OF * 1316 OF * 1317 OF * 1318 OF * 1319 OF * 1320 OF

Motor / Motor / Engine

Bomba hidráulica / Bomba hidráulica / Hydraulic pump				62204 2RS	0049819625	BB
Bomba injetora (dianteiro) / Bomba inyectora (delantero) / Injection pump (front)				30203 F	000720030203	TRB
				30205 F	000720030205	TRB
Bomba injetora (traseiro) / Bomba inyectora (traseiro) / Injection pump (rear)				30204 F	000720030204	TRB
			OM 366	30205 F		TRB
			OM 366 LA	30206 F		TRB
Virabrequim / Cigüeñal / Crankshaft				6204 2RS / C3	000625406204	BB
Polia tensora / Polea tensora / Tensioner pulley				6303	000635006303	BB
Ventilador (traseiro) / Ventilador (traseiro) / Fan (rear)				6304 C3	000635006303	BB
Virabrequim - ponta / Cigüeñal - punta / Crankshaft spindle			OM 366/A * OM 352/A/I * OM 366 G * OM 366 LA	6204 2RS		BB

Tomada de Força / Toma de Fuerza / Power Take-off

Eixo de saída (traseiro) / Eje de salida (traseiro) / Output shaft (rear)			G 3/60-5/7,5 + NA 3/60-1B * G 3/60-5/8,5 + NA 3/60-1B	6007 N		BB
---	--	--	--	---------------	--	----



Tomada de Potência / Toma de Potencia / Power Take-off

Eixo primário (traseiro) / Eje primario (traseiro) / Primary shaft (rear)				6007 N	000625506007	BB
---	--	--	--	---------------	--------------	----

1414 * 1414 (K*L*LA*LAK*LK) * 1418 * 1418 (E*K*R) * 1418 (L*LA*LAK*LK*(LK)) * 1419 (L*LK*LS) * 1420 (L*LK*LS)

Caixa de Mudanças / Caja de Cambios / Gearbox

Eixo de acionamento / Eje de accionamiento / Drive shaft				NUP 2212 FMN		CRB
Eixo intermediário / Eje intermedio / Intermediate shaft				2789 / 2720		TRB
				3382 / 3320		TRB
Eixo Intermediário (dianteiro/traseiro) / Eje Intermedio (delantero/traseiro) / Intermediate shaft (front/rear)				30309 F	00198113705	TRB
				30308 F	0019813105 / 0019815005	TRB
				32208 F	A0159813405	TRB
			G 3/61-5/6,1 * G 3/60-5/7,5 * G 3/50-5/8,5 * G 3/60-5/7,5 + NA 3/60-1B * G 3/50-5/8,5 + NA 3/60-1B * G 3/60-5/8,5 + NA 3/60-1B	30308 F		TRB
Eixo primário / Eje primario / Primary shaft			G 3/55-6/8,5	F 19047		CRBS
Eixo primário (dianteiro) / Eje primario (delantero) / Primary shaft (front)			G 3/61-5/6,1 * G 3/60-5/7,5 * G 3/50-5/8,5 * G 3/50-5/8,5 + NA 3/60-1B * G 3/60-5/8,5 + NA 3/60-1B * G 3/5-5/8,5	QJ 212 FM		BB4PAC
				QJ 212 FM	3459817627	BB4PAC
Eixo primário (traseiro) / Eje primario (traseiro) / Primary shaft (rear)			G 3/61-5/6,1 * G 3/60-5/7,5 * G 3/50-5/8,5 * G 3/50-5/8,5 + NA 3/60-1B * G 3/60-5/8,5 + NA 3/60-1B * G 3/5-5/8,5	F 19011		CRBS
Eixo primário inf. (dianteiro/traseiro) / Eje primario inf. (delantero/traseiro) / Primary shaft - lower (front/rear)				NJ 2211 FM	000628000339	CRB
Eixo primário sup. (dianteiro) / Eje primario sup. (delantero) / Upper primary shaft (front)				30309 F	00198113705	TRB
Eixo primário sup. (traseiro) / Eje primario sup. (traseiro) / Upper primary shaft (rear)				30308 F	0019813105 / 0019815005	TRB
Eixo principal / Eje principal / Main shaft				NUP 310 FMN / C3		CRB
Eixo principal (entrada / saída) / Eje principal (entrada / salida) / Main shaft (input / output)				32210 F	A0159815005	TRB

	OUT	IN		Fersa®	Nº OEM	
---	-----	----	---	---------------	--------	---

MERCEDES BENZ (SA)

1414 * 1414 (K*L*LA*LAK*LK) * 1418 * 1418 (E*K*R) * 1418 (L*LA*LAK*LK*R(LK)) * 1419 (L*LK*LS) * 1420 (L*LK*LS)

Caixa de Mudanças / Caja de Cambios / Gearbox

Eixo secundário / Eje secundario / Secondary shaft			G 3/55-6/8,5	F 19046		CRBS
Eixo secundário (traseiro) / Eje secundario (trasero) / Secondary shaft (rear)			G 3/55-6/8,5	F 19046		CRBS
				QJ 309 FM	3459817127 / 3459817727	BB4PAC
Tomada de força / Toma de fuerza / Power take-off				6208 N		BB

Eixo Traseiro / Eje Trasero / Rear Axle

Diferencial - caixa sat.lat. (dir.) / Diferencial - caja sat.lat. (der.) / Differential - satellit box (right)				32014 XF	005 981 6605	TRB
				32022 XF	002 981 5005	TRB
Diferencial - caixa sat.lat (esq.) / Diferencial - caja sat.lat. (izq.) / Differential - satellit box (left)				32017 XF	005 981 1405	TRB
Diferencial - coroa lateral (dir./esq.) / Diferencial - corona lateral (der./izq.) / Differential - crown gear (right/left)			HL 4/60 D-10 * HL 4/061 D-11,5 * HH 4/05 D-10/43:10 * HH 4/07 DL-10/41:7 * HH 4/07 DL-10/47:9	32018 XF		TRB
			HL 5/60 DZ-10 * HL 5/60 DZ-10/39:8	32020 XF		TRB
			HH 4/12-10/41:11 * HH 4/12D-10/40:7 * HL 4/26 D-9,2/43:7 * HH 4/12 D-10/41:11 * HL 4/26 D-9,2/40:7	47487 / 47420 A		TRB
Diferencial - pinhão (traseiro) / Diferencial - piñón (trasero) / Differential - pinion (rear)			HL 5/2 DZ-10/48:7 * HH 4/12 D-10/41:11 * HL 4/26 D-9,2/40:7 * HL 5/2 DZ-10/43:7 * HL 5/60 DZ-10 * HL 5/60 DZ-10/39:8	F 15083		STRB
				F 15083	003981190 (77...)/5	STRB
Diferencial (traseiro) / Diferencial (trasero) / Differential - differential (rear)			HL 5/2 DZ 10/48:7	32020 XF		TRB

Direção / Dirección / Steering

Inferior / Inferior / Lower				30205 F	000720030205	TRB
Braço superior / Brazo superior / Upper arm				30206 F	000720030206	TRB

Eixo Dianteiro / Eje Delantero / Front Axle

Roda / Rueda / Wheel	•			33208 F	3849817605 / 0089810105	TRB
	•			33210 F	003 981 8305	TRB
		•		33213 F	0089810005	TRB
		•		33214 F	003 981 5205	TRB
		•		559 / 552 A	3449817005	TRB
	•		VL 3/7 D-5 (504304 38/39/40/41/44/45/46/47/50/51) * VL 3/8 D-6,5	33210 F		TRB

Eixo Traseiro / Eje Trasero / Rear Axle

Roda / Rueda / Wheel		•	HL 4/D2-8/46:7	32216 F		TRB
		•		33019 F	00298190 (77...)/05 / 0039818605	TRB
	•			33020 F	0059818505	TRB
		•		33020 F	014 981 3205	TRB
	•			33116 F	012 981 4005	TRB
	•		HH 4/05 D-10/43:10 * HH 4/07 DL-10/41:7 * HH 4/07 DL-10/47:9	33117 F		TRB
		•		33117 F	0059818605	TRB

	OUT	IN		Fersa®	N° OEM	
---	-----	----	---	---------------	--------	---

MERCEDES BENZ (SA)

1414 * 1414 (K*LA*LAK*LK) * 1418 * 1418 (E*K*R) * 1418 (L*LA*LAK*LK*R(LK)) * 1419 (L*LK*LS) * 1420 (L*LK*LS)

Eixo Traseiro / Eje Trasero / Rear Axle

	•			33215 F	0029818905 / 0029818605	TRB
		•		598 A / 593 X	0039811405	TRB

Motor / Motor / Engine

Alternador (dianteiro) / Alternador (delantero) / Alternator (front)				6303 2RS / C3	000625406303 / 000625900193	BB
				6304 2RS / C3	0049812425	BB
			OM 366 * OM 366 A (Bosch/Valeo 14V 55 A) * OM 366 LA II/23	6403 2RS / C3		BB
Alternador (traseiro) / Alternador (trasero) / Alternator (rear)				62201 2RS / C3	00298190 (77...)95	BB
Bomba d'água (dianteiro) / Bomba de agua (delantero) / Water pump (front)				6203	000625900208	BB
Bomba d'água (traseiro) / Bomba de agua (trasero) / Water pump (rear)				6206	000625006206	BB
			OM 366 * OM 366 A * OM 366 LA	6203 C3		BB
Bomba hidráulica / Bomba hidráulica / Hydraulic pump				62204 2RS	0049819625	BB
Bomba injetora (dianteiro) / Bomba inyectora (delantero) / Injection pump (front)				30203 F	000720030203	TRB
				30204 F	000720030204	TRB
Virabrequim / Cigüeñal / Crankshaft				6204 2RS / C3	000625406204	BB
Polia tensora (dianteiro) / Polea tensora (delantero) / Tensioner pulley (front)				30205 F	000720030205	TRB
Polia tensora (traseiro) / Polea tensora (trasero) / Tensioner pulley (rear)				30204 F	000720030204	TRB
Polia tensora - rodam (dianteiro) / Polea tensora - rodam. delantero / Tensioner pulley - bearing (front)			OM 355/5 * OH-1419/1420	30205 F		TRB
Polia tensora - rodam (traseiro) / Polea tensora - rodam. trasero / Tensioner pulley - bearing (rear)			OM 355/5 * OH-1419/1420	30204 F		TRB
Ventilador (dianteiro) / Ventilador (delantero) / Fan (front)				30205 F	000720030205	TRB
Ventilador (traseiro) / Ventilador (trasero) / Fan (rear)				30204 F	000720030204	TRB
Virabrequim - ponta / Cigüeñal - punta / Crankshaft spindle			OM 366/A * OM 355/5	6204 2RS		BB
Virabrequim - ponta / Cigüeñal - punta / Crankshaft spindle			OM 366 * OM 366 A * OM 366 LA * OM 366 LA II/23	6204 2RS		BB



Tomada de Força / Toma de Fuerza / Power Take-off

Eixo de saída (traseiro) / Eje de salida (trasero) / Output shaft (rear)			G 3/60-5/7,5 + NA 3/60-1B * G 3/60-5/8,5 + NA 3/60-1B * G 3/50-5/8,5 + NA 3/60-1B	6007 N		BB
Eixo primário (dianteiro) / Eje primario (delantero) / Primary shaft (front)				6208 N	000625506208	BB
Eixo primário (traseiro) / Eje primario (trasero) / Primary shaft (rear)				6007 N	000625506007	BB

1417 OF * 1419 OF * 1421 OF

Caixa de Mudanças / Caja de Cambios / Gearbox

Eixo de acionamento / Eje de accionamiento / Drive shaft				NUP 2212 FMN		CRB
Eixo intermediário / Eje intermedio / Intermediate shaft				2789 / 2720		TRB
				3382 / 3320		TRB
Eixo Intermediário (dianteiro/traseiro) / Eje Intermedio (delantero/trasero) / Intermediate shaft (front/rear)				30309 F	00198113705	TRB

	OUT	IN		Fersa®	Nº OEM	
---	-----	----	---	---------------	--------	---

MERCEDES BENZ (SA)

1417 OF * 1419 OF * 1421 OF

Caixa de Mudanças / Caja de Cambios / Gearbox

Eixo Intermediário (dianteiro/traseiro) / Eje Intermedio (delantero/trasero) / Intermediate shaft (front/rear)				30308 F	0019813105 / 0019815005	TRB
				32208 F	A0159813405	TRB
		G 3/61-5/6,1 * G 3/60-5/7,5 * G 3/50-5/8,5 * G 3/60-5/7,5 + NA 3/60-1B * G 3/50-5/8,5 + NA 3/60-1B * G 3/60-5/8,5 + NA 3/60-1B		30308 F		TRB
Eixo primário / Eje primario / Primary shaft		G 3/55-6/8,5		F 19047		CRBS
Eixo primário (dianteiro) / Eje primario (delantero) / Primary shaft (front)		G 3/61-5/6,1 * G 3/60-5/7,5 * G 3/50-5/8,5 * G 3/50-5/8,5 + NA 3/60-1B * G 3/60-5/8,5 + NA 3/60-1B * G 3/5-5/8,5		QJ 212 FM		BB4PAC
				QJ 212 FM	3459817627	BB4PAC
Eixo primário (traseiro) / Eje primario (trasero) / Primary shaft (rear)		G 3/61-5/6,1 * G 3/60-5/7,5 * G 3/50-5/8,5 * G 3/50-5/8,5 + NA 3/60-1B * G 3/60-5/8,5 + NA 3/60-1B * G 3/5-5/8,5		F 19011		CRBS
Eixo primário inf. (dianteiro/traseiro) / Eje primario inf. (delantero/trasero) / Primary shaft - lower (front/rear)				NJ 2211 FM	000628000339	CRB
Eixo primário sup. (dianteiro) / Eje primario sup. (delantero) / Upper primary shaft (front)				30309 F	00198113705	TRB
Eixo primário sup. (traseiro) / Eje primario sup. (trasero) / Upper primary shaft (rear)				30308 F	0019813105 / 0019815005	TRB
Eixo principal / Eje principal / Main shaft				NUP 310 FMN / C3		CRB
Eixo principal (entrada / saída) / Eje principal (entrada / salida) / Main shaft (input / output)				32210 F	A0159815005	TRB
Eixo secundário / Eje secundario / Secondary shaft		G 3/55-6/8,5		F 19046		CRBS
Eixo secundário (traseiro) / Eje secundario (trasero) / Secondary shaft (rear)		G 3/55-6/8,5		F 19046		CRBS
Eixo secundário (traseiro) / Eje secundario (trasero) / Secondary shaft (rear)				QJ 309 FM	3459817127 / 3459817727	BB4PAC
Tomada de força / Toma de fuerza / Power take-off				6208 N		BB
Eixo Traseiro / Eje Trasero / Rear Axle						
Diferencial - caixa sat.lat. (dir.) / Diferencial - caja sat.lat. (der.) / Differential - satellit box (right)				32014 XF	005 981 6605	TRB
Diferencial - caixa sat.lat. (dir.) / Diferencial - caja sat.lat. (der.) / Differential - satellit box (right)				32022 XF	002 981 5005	TRB
Diferencial - caixa sat.lat. (esq.) / Diferencial - caja sat.lat. (izq.) / Differential - satellit box (left)				32017 XF	005 981 1405	TRB
Diferencial - coroa lateral (dir./esq.) / Diferencial - corona lateral (der./izq.) / Differential - crown gear (right/left)		HL 4/60 D-10 * HL 4/061 D-11,5 * HH 4/05 D-10/43:10 * HH 4/07 DL-10/41:7 * HH 4/07 DL-10/47:9		32018 XF		TRB
		HL 5/60 DZ-10 * HL 5/60 DZ-10/39:8		32020 XF		TRB
		HH 4/12-10/41:11 * HH 4/12D-10/40:7 * HL 4/26 D-9,2/43:7 * HH 4/12 D-10/41:11 * HL 4/26 D-9,2/40:7		47487 / 47420 A		TRB

	OUT	IN		Fersa®	Nº OEM	
---	-----	----	---	---------------	--------	---

MERCEDES BENZ (SA)

1417 OF * 1419 OF * 1421 OF

Eixo Traseiro / Eje Trasero / Rear Axle

Diferencial - pinhão (traseiro) / Diferencial - piñón (trasero) / Differential - pinion (rear)			HL 5/2 DZ-10/48:7 * HH 4/12 D-10/41:11 * HL 4/26 D-9,2/40:7 * HL 5/2 DZ-10/43:7 * HL 5/60 DZ-10 * HL 5/60 DZ-10/39:8	F 15083		STRB
				F 15083	003981190 (77...)5	STRB
Diferencial (traseiro) / Diferencial (trasero) / Differential - differential (rear)			HL 5/2 DZ 10/48:7	32020 XF		TRB

Direção / Dirección / Steering

Inferior / Inferior / Lower				30205 F	000720030205	TRB
Braço superior / Brazo superior / Upper arm				30206 F	000720030206	TRB

Eixo Dianteiro / Eje Delantero / Front Axle



Roda / Rueda / Wheel	•			33208 F	3849817605 / 0089810105	TRB
	•			33210 F	003 981 8305	TRB
		•		33213 F	0089810005	TRB
		•		33214 F	003 981 5205	TRB
		•		559 / 552 A	3449817005	TRB
	•		VL 3/7 D-5 (504304 38/39/40/41/44/45/46/47/50/51) * VL 3/8 D-6,5	33210 F		TRB

Eixo Traseiro / Eje Trasero / Rear Axle

Roda / Rueda / Wheel		•	HL 4/D2-8/46:7	32216 F		TRB
		•		33019 F	00298190 (77...)05 / 0039818605	TRB
		•		33020 F	0059818505	TRB
		•		33020 F	014 981 3205	TRB
		•		33116 F	012 981 4005	TRB
	•		HH 4/05 D-10/43:10 * HH 4/07 DL-10/41:7 * HH 4/07 DL-10/47:9	33117 F		TRB
		•		33117 F	0059818605	TRB
	•			33215 F	0029818905 / 0029818605	TRB
		•		598 A / 593 X	0039811405	TRB

Motor / Motor / Engine

Alternador (dianteiro) / Alternador (delantero) / Alternator (front)				6303 2RS / C3	000625406303 / 000625900193	BB
				6304 2RS / C3	0049812425	BB
			OM 366 * OM 366 A (Bosch/Valeo 14V 55 A) * OM 366 LA II/23	6403 2RS / C3		BB
Alternador (traseiro) / Alternador (trasero) / Alternator (rear)				62201 2RS / C3	00298190 (77...)95	BB
Bomba d'água (dianteiro) / Bomba de agua (delantero) / Water pump (front)				6203	000625900208	BB
Bomba d'água (traseiro) / Bomba de agua (trasero) / Water pump (rear)				6206	000625006206	BB
			OM 366 * OM 366 A * OM 366 LA	6203 C3		BB
Bomba hidráulica / Bomba hidráulica / Hydraulic pump				62204 2RS	0049819625	BB
Bomba injetora (dianteiro) / Bomba inyectora (delantero) / Injection pump (front)				30203 F	000720030203	TRB
				30204 F	000720030204	TRB
Virabrequim / Cigüeñal / Crankshaft				6204 2RS / C3	000625406204	BB

	OUT	IN		Fersa®	N° OEM	
---	-----	----	---	---------------	--------	---

MERCEDES BENZ (SA)

1417 OF * 1419 OF * 1421 OF

Motor / Motor / Engine

Polia tensora (dianteiro) / Polea tensora (delantero) / Tensioner pulley (front)				30205 F	000720030205	TRB
Polia tensora (traseiro) / Polea tensora (trasero) / Tensioner pulley (rear)				30204 F	000720030204	TRB
Polia tensora - rolam (dianteiro) / Polea tensora - rodam. delantero / Tensioner pulley - bearing (front)			OM 355/5 * OH-1419/1420	30205 F		TRB
Polia tensora - rolam (traseiro) / Polea tensora - rodam. trasero / Tensioner pulley - bearing (rear)			OM 355/5 * OH-1419/1420	30204 F		TRB
Ventilador (dianteiro) / Ventilador (delantero) / Fan (front)				30205 F	000720030205	TRB
Ventilador (traseiro) / Ventilador (trasero) / Fan (rear)				30204 F	000720030204	TRB
Virabrequim - ponta / Cigüeñal - punta / Crankshaft spindle			OM 366/A * OM 355/5	6204 2RS		BB
			OM 366 * OM 366 A * OM 366 LA * OM 366 LA II/23	6204 2RS		BB

Tomada de Força / Toma de Fuerza / Power Take-off

Eixo de saída (traseiro) / Eje de salida (trasero) / Output shaft (rear)			G 3/60-5/7,5 + NA 3/60-1B * G 3/60-5/8,5 + NA 3/60-1B * G 3/50-5/8,5 + NA 3/60-1B	6007 N		BB
--	--	--	--	---------------	--	----

Tomada de Potência / Toma de Potencia / Power Take-off

Eixo primário (dianteiro) / Eje primario (delantero) / Primary shaft (front)				6208 N	000625506208	BB
Eixo primário (traseiro) / Eje primario (trasero) / Primary shaft (rear)				6007 N	000625506007	BB

1421 OMC

Caixa de Mudanças / Caja de Cambios / Gearbox

Eixo de acionamento / Eje de accionamiento / Drive shaft				NUP 2212 FMN		CRB
Eixo intermediário / Eje intermedio / Intermediate shaft				2789 / 2720		TRB
				3382 / 3320		TRB
				30309 F	00198113705	TRB
Eixo Intermediário (dianteiro/traseiro) / Eje Intermedio (delantero/trasero) / Intermediate shaft (front/rear)				30308 F	0019813105 / 0019815005	TRB
				32208 F	A0159813405	TRB
			G 3/61-5/6,1 * G 3/60-5/7,5 * G 3/50-5/8,5 * G 3/60-5/7,5 + NA 3/60-1B * G 3/50-5/8,5 + NA 3/60-1B * G 3/60-5/8,5 + NA 3/60-1B	30308 F		TRB
			G 3/55-6/8,5	F 19047		CRBS
Eixo primário (dianteiro) / Eje primario (delantero) / Primary shaft (front)			G 3/61-5/6,1 * G 3/60-5/7,5 * G 3/50-5/8,5 * G 3/50-5/8,5 + NA 3/60-1B * G 3/60-5/8,5 + NA 3/60-1B * G 3/5-5/8,5	QJ 212 FM		BB4PAC
				QJ 212 FM	3459817627	BB4PAC
Eixo primário (traseiro) / Eje primario (trasero) / Primary shaft (rear)			G 3/61-5/6,1 * G 3/60-5/7,5 * G 3/50-5/8,5 * G 3/50-5/8,5 + NA 3/60-1B * G 3/60-5/8,5 + NA 3/60-1B * G 3/5-5/8,5	F 19011		CRBS
Eixo primário inf. (dianteiro/traseiro) / Eje primario inf. (delantero/trasero) / Primary shaft - lower (front/rear)				NJ 2211 FM	000628000339	CRB
Eixo primário sup. (dianteiro) / Eje primario sup. (delantero) / Upper primary shaft (front)				30309 F	00198113705	TRB

	OUT	IN		Fersa®	N° OEM	
---	-----	----	---	---------------	--------	---

MERCEDES BENZ (SA)

1421 OMC

Caixa de Mudanças / Caja de Cambios / Gearbox

Eixo primário sup. (traseiro) / Eje primario sup. (traseiro) / Upper primary shaft (rear)				30308 F	0019813105 / 0019815005	TRB
Eixo principal / Eje principal / Main shaft				NUP 310 FMN / C3		CRB
Eixo principal (entrada / saída) / Eje principal (entrada / salida) / Main shaft (input / output)				32210 F	A0159815005	TRB
Eixo secundário / Eje secundario / Secondary shaft			G 3/55-6/8,5	F 19046		CRBS
Eixo secundário (traseiro) / Eje secundario (traseiro) / Secondary shaft (rear)			G 3/55-6/8,5	F 19046		CRBS
				QJ 309 FM	3459817127 / 3459817727	BB4PAC
Tomada de força / Toma de fuerza / Power take-off				6208 N		BB

Eixo Traseiro / Eje Trasero / Rear Axle

Diferencial - caixa sat.lat. (dir.) / Diferencial - caja sat.lat. (der.) / Differential - satellit box (right)				32014 XF	005 981 6605	TRB
				32022 XF	002 981 5005	TRB
Diferencial - caixa sat.lat. (esq.) / Diferencial - caja sat.lat. (izq.) / Differential - satellit box (left)				32017 XF	005 981 1405	TRB
Diferencial - coroa lateral (dir./esq.) / Diferencial - corona lateral (der./izq.) / Differential - crown gear (right/left)			HL 4/60 D-10 * HL 4/061 D-11,5 * HH 4/05 D-10/43:10 * HH 4/07 DL-10/41:7 * HH 4/07 DL-10/47:9	32018 XF		TRB
			HL 5/60 DZ-10 * HL 5/60 DZ-10/39:8	32020 XF		TRB
			HH 4/12-10/41:11 * HH 4/12D-10/40:7 * HL 4/26 D-9,2/43:7 * HH 4/12 D-10/41:11 * HL 4/26 D-9,2/40:7	47487 / 47420 A		TRB
Diferencial - pinhão (traseiro) / Diferencial - piñón (traseiro) / Differential - pinion (rear)			HL 5/2 DZ-10/48:7 * HH 4/12 D-10/41:11 * HL 4/26 D-9,2/40:7 * HL 5/2 DZ-10/43:7 * HL 5/60 DZ-10 * HL 5/60 DZ-10/39:8	F 15083		STRB
Diferencial - pinhão (traseiro) / Diferencial - piñón (traseiro) / Differential - pinion (rear)				F 15083	003981190 (77...)5	STRB
Diferencial (traseiro) / Diferencial (traseiro) / Differential - differential (rear)			HL 5/2 DZ 10/48:7	32020 XF		TRB

Direção / Dirección / Steering



Inferior / Inferior / Lower				30205 F	000720030205	TRB
Braço superior / Brazo superior / Upper arm				30206 F	000720030206	TRB

Eixo Dianteiro / Eje Delantero / Front Axle

Roda / Rueda / Wheel	•			33208 F	3849817605 / 0089810105	TRB
	•			33210 F	003 981 8305	TRB
		•		33213 F	0089810005	TRB
		•		33214 F	003 981 5205	TRB
		•		559 / 552 A	3449817005	TRB
	•		VL 3/7 D-5 (504304 38/39/40/41/44/45/46/47/50/51) * VL 3/8 D-6,5	33210 F		TRB

Eixo Traseiro / Eje Trasero / Rear Axle

Roda / Rueda / Wheel		•	HL 4/D2-8/46:7	32216 F		TRB
		•		33019 F	00298190 (77...)05 / 0039818605	TRB
		•		33020 F	0059818505	TRB

	OUT	IN		Fersa®	Nº OEM	
---	-----	----	---	---------------	--------	---

MERCEDES BENZ (SA)

1421 OMC

Eixo Traseiro / Eje Trasero / Rear Axle

Roda / Rueda / Wheel		•		33020 F	014 981 3205	TRB
	•			33116 F	012 981 4005	TRB
	•		HH 4/05 D-10/43:10 * HH 4/07 DL-10/41:7 * HH 4/07 DL-10/47:9	33117 F		TRB
		•		33117 F	0059818605	TRB
	•			33215 F	0029818905 / 0029818605	TRB
		•		598 A / 593 X	0039811405	TRB

Motor / Motor / Engine

Alternador (dianteiro) / Alternador (delantero) / Alternator (front)				6303 2RS / C3	000625406303 / 000625900193	BB
				6304 2RS / C3	0049812425	BB
			OM 366 * OM 366 A (Bosch/Valeo 14V 55 A) * OM 366 LA II/23	6403 2RS / C3		BB
Alternador (traseiro) / Alternador (trasero) / Alternator (rear)				62201 2RS / C3	00298190 (77...)95	BB
Bomba d'água (dianteiro) / Bomba de agua (delantero) / Water pump (front)				6203	000625900208	BB
Bomba d'água (traseiro) / Bomba de agua (trasero) / Water pump (rear)				6206	000625006206	BB
			OM 366 * OM 366 A * OM 366 LA	6203 C3		BB
Bomba hidráulica / Bomba hidráulica / Hydraulic pump				62204 2RS	0049819625	BB
Bomba injetora (dianteiro) / Bomba inyectora (delantero) / Injection pump (front)				30203 F	000720030203	TRB
				30204 F	000720030204	TRB
Virabrequim / Cigüeñal / Crankshaft				6204 2RS / C3	000625406204	BB
Polia tensora (dianteiro) / Polea tensora (delantero) / Tensioner pulley (front)				30205 F	000720030205	TRB
Polia tensora (traseiro) / Polea tensora (trasero) / Tensioner pulley (rear)				30204 F	000720030204	TRB
Polia tensora - rodam (dianteiro) / Polea tensora - rodam.delantero / Tensioner pulley - bearing (front)			OM 355/5 * OH-1419/1420	30205 F		TRB
			OM 355/5 * OH-1419/1420	30204 F		TRB
Ventilador (dianteiro) / Ventilador (delantero) / Fan (front)				30205 F	000720030205	TRB
Ventilador (traseiro) / Ventilador (trasero) / Fan (rear)				30204 F	000720030204	TRB
Virabrequim - ponta / Cigüeñal - punta / Crankshaft spindle			OM 366/A * OM 355/5	6204 2RS		BB
			OM 366 * OM 366 A * OM 366 LA * OM 366 LA II/23	6204 2RS		BB

Tomada de Força / Toma de Fuerza / Power Take-off

Eixo de saída (traseiro) / Eje de salida (trasero) / Output shaft (rear)			G 3/60-5/7,5 + NA 3/60-1B * G 3/60-5/8,5 + NA 3/60-1B * G 3/50-5/8,5 + NA 3/60-1B	6007 N		BB
---	--	--	---	---------------	--	----

Tomada de Potência / Toma de Potencia / Power Take-off

Eixo primário (dianteiro) / Eje primario (delantero) / Primary shaft (front)				6208 N	000625506208	BB
Eixo primário (traseiro) / Eje primario (trasero) / Primary shaft (rear)				6007 N	000625506007	BB



MERCEDES BENZ (SA)

1513 (L*LA*LAK*LB*LG*LK*LS) * 1514 (L*LK*LS) * 1516 (L*LA*LAK*LB*LG*LK*LS) * 1517 (L*LK) * 1518 (L*LK*LS) *
1519 (L*LAK*LB*LG*LK*LS) * 1520 (L*LK*LP*LPK*LPS*LS) * 1521 L * 1524 * 1525 (L*LK*LS)

Caixa de Mudanças / Caja de Cambios / Gearbox

Eixo de entrada / Eje de entrada / Input shaft				6209 C3	000625036209	BB
			718052	6209 C3		BB
Eixo de saída (traseiro) / Eje de salida (trasero) / Output shaft (rear)				6007 N	000625506007	BB
				6208 N	000625506208	BB
Eixo intermediário / Eje intermedio / Intermediate shaft				6208 N	000625506208	BB
Eixo intermediário (dianteiro) / Eje intermedio (delantero) / Intermediate shaft (front)				33885 / 33822	0019809602	TRB
Eixo Intermediário (dianteiro/traseiro) / Eje Intermedio (delantero/trasero) / Intermediate shaft (front/rear)				30308 F	0019813105 / 0019815005	TRB
				33889 / 33822	0019809502	TRB
Eixo primário / Eje primario / Primary shaft				6208 N	000625506208	BB
			AK 6-80/9,0	NUP 314 FMNR / C3		CRB
Eixo primário (dianteiro) / Eje primario (delantero) / Primary shaft (front)				QJ 209 FM	3459817027	BB4PAC
				QJ 212 FM	3459817627	BB4PAC
Eixo primário (traseiro) / Eje primario (trasero) / Primary shaft (rear)			3/60-5/6,1 * G 3/61-5/6,1 * G 3/50-5/8,5 * G 3/60-5/7,5 * AK 6-80/9,0 * AK 6-80/9,0 GV 80 * G 3/60-5/7,5 + NA 3/60-1B * G 3/60-5/8	F 19011		CRBS
				NU 209 FMN	3449817101	CRB
Eixo secundário / Eje secundario / Secondary shaft				F 19019	0049815801	CRBS
Eixo secundário (interm.) / Eje secundario (interm.) / Secondary shaft (interm.)			LP/LPK/LPS-1520	NUP 314 FM		CRB
Eixo secundário (traseiro) / Eje secundario (trasero) / Secondary shaft (rear)			LP/LPK/LPS-1520	6314		BB
				6314 N / C3	00198190 (77...)25	BB
			G 3/60-5/6,1 * G 3/36-5/8,98 * G 3/40-5/7,5 * G 3/61-5/6,1 * G 3/50-5/8,5 * G 3/60-5/7,5 * AK 6-80/9,0 * AK 6-80/9,0 GV 80 * G 3/60-5/7,5 + NA 3/60-1B	QJ 309 FM		BB4PAC
			QJ 309 FM	3459817127 / 3459817727		BB4PAC
Motor traseira / Motor trasero / Rear engine				NUP 314 FM / C3	0019809802	CRB

Cardan / Cardan / Cardan

Suporte / Soporte / Support				6210	000625006210	BB
			LP/LPK/LPS-1520	6210		BB

Eixo Traseiro / Eje Trasero / Rear Axle

Diferencial - coroa lateral (dir./esq.) / Diferencial - corona lateral (der./izq.) / Differential - crown gear (right/left)			HL 4/01 D-10/38:8 * HL 4/01 D-10 * HL4/01 D-10/ 48:7 * HH 4/05 D-10/43:10	32018 XF		TRB
			HL 5/2 D-10/39:8 * HL 5/2 DZ-10/48:7 * HL 5/2 D-10/45:8 * HL 5/2-10/39:8	32020 XF		TRB
			HH 4/12-10/40:7 * HL 4/27 D-10/43:7 * HH 4/12-10/40:7 * HH 4/12-10/40:7	47487 / 47420 A		TRB

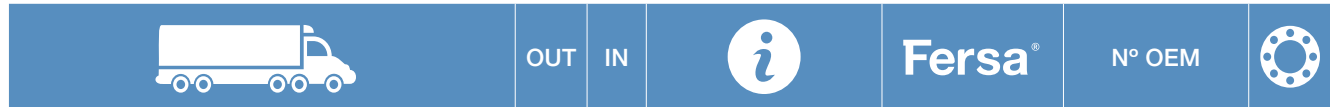

MERCEDES BENZ (SA)

1513 (L*LA*LAK*LB*LG*LK*LS) * 1514 (L*LK*LS) * 1516 (L*LA*LAK*LB*LG*LK*LS) * 1517 (L*LK) * 1518 (L*LK*LS) * 1519 (L*LAK*LB*LG*LK*LS) * 1520 (L*LK*LP*LPK*LPS*LS) * 1521 L * 1524 * 1525 (L*LK*LS)

Eixo Traseiro / Eje Trasero / Rear Axle

Diferencial - pinhão (dianteiro) / Diferencial - piñón (delantero) / Differential - pinion (front)			LP/LPK/LPS-1520	HM 807046 / HM 807010		TRB
Diferencial - pinhão apoio / Diferencial - piñón apoyo / Differential - support pinion				F 15083	003981190 (77...) ⁵	STRB
Diferencial - pinhão (dianteiro) / Diferencial - piñón (delantero) / Differential - pinion (front)				HM 807046 / HM 807010	031981190 (77...) ⁵	TRB
Diferencial - pinhão (traseiro) / Diferencial - piñón (trasero) / Differential - pinion (rear)			HL 5/2D-10/39:8 * HL 5/2DZ-10/48:7 * HL 5/2D-10/45:8 * HL 5/2-10/39:8	F 15083		STRB

Direção / Dirección / Steering

Direção hidráulica - árvore artic. (sup.) / Dirección hidráulica - árbol artic. (sup.) / Hydraulic direction - artic. shaft (upper)			LP/LPK/LPS-1520	6007		BB
---	--	--	-----------------	-------------	--	----

Eixo Dianteiro / Eje Delantero / Front Axle

Roda / Rueda / Wheel		•	LP/LPK/LPS-1520	30313 F		TRB
		•		32307 F	0039816405	TRB
		•	LP/LPK/LPS-1520	32309 F		TRB
		•		33208 F	3849817605 / 0089810105	TRB
		•		33213 F	0089810005	TRB
		•		559 / 552 A	3449817005	TRB

Eixo Traseiro / Eje Trasero / Rear Axle

Roda / Rueda / Wheel		•		32216 F	0009817205	TRB
		•		32218 F	000720032218	TRB
		•		33019 F	00298190 (77...) ⁰⁵ / 0039818605	TRB
		•		33020 F	0059818505	TRB
		•		33117 F	0059818605	TRB
		•		33215 F	0029818905 / 0029818605	TRB
				497 / 492 A	0009816105	TRB
				498 / 492 A	0039812005	TRB
		•	LP/LPK/LPS-1520	580 / 572		TRB
		•		598 A / 593 X	0039811405	TRB
				H 715345 / H 715311	0319811805	TRB

Embreagem / Embrague / Clutch

Apoio / Apoyo / Support			344938/955/963	6204 2RS		BB
				6204 2RS / C3	000625406204	BB
				6205 2RS	000625406205	BB

Motor / Motor / Engine

Alternador (dianteiro) / Alternador (delantero) / Alternator (front)				6303 2RS / C3	000625406303 / 000625900193	BB
				6303 RS / C3	000625900182	BB
Alternador (dianteiro/traseiro) / Alternador (delantero/trasero) / Alternator (front/rear)				6403 2RS / C3	0049812425 / 0049811825	BB
Alternador (traseiro) / Alternador (trasero) / Alternator (rear)				6201 2RS / C3	0089810705	BB
				6201 RS / C3	0049812425	BB



OUT

IN



Fersa®

N° OEM



MERCEDES BENZ (SA)

1513 (L*LA*LAK*LB*LG*LK*LS) * 1514 (L*LK*LS) * 1516 (L*LA*LAK*LB*LG*LK*LS) * 1517 (L*LK) * 1518 (L*LK*LS) * 1519 (L*LAK*LB*LG*LK*LS) * 1520 (L*LK*LP*LPK*LPS*LS) * 1521 L * 1524 * 1525 (L*LK*LS)



Motor / Motor / Engine

Alternador (traseiro) / Alternador (trasero) / Alternator (rear)				6204 2RS / C3	000625406204	BB
				6205 2RS	000625406205	BB
				62201 2RS / C3	00298190 (77...)25	BB
				6403 2RS / C3		BB
Bomba d'água (dianteiro) / Bomba de agua (delantero) / Water pump (front)				6204	000625006204	BB
Bomba d'água (dianteiro/traseiro) / Bomba de agua (delantero/trasero) / Water pump (front/rear)				6203 C3	000625900208	BB
Bomba d'água (traseiro) / Bomba de agua (trasero) / Water pump (rear)				6004	000625006004	BB
			OM 366 A/LA	6203 C3		BB
				6206 C3	000625900209	BB
				NU 303 FM	0019819601	CRB
Bomba hidráulica / Bomba hidráulica / Hydraulic pump				62204 2RS	0049819625	BB
Bomba injetora (dianteiro) / Bomba inyectora (delantero) / Injection pump (front)				6305	000625006305	BB
				30203 F	000720030203	TRB
				32205 F	000720032205	TRB
Bomba injetora (dianteiro/traseiro) / Bomba inyectora (delantero/trasero) / Injection pump (front/rear)			OM 355/5A	32205 BF		TRB
Bomba injetora (traseiro) / Bomba inyectora (trasero) / Injection pump (rear)				6205	000625006205	BB
				30205 F	000720030205	TRB
Compressor / Compresor / Compressor			LP-1520	6011		BB
Compressor (dianteiro) / Compresor (delantero) / Compressor (front)			OM 355/5A	NJ 305 C3		CRB
Compressor de ar / Compresor de aire / Air compressor				6011	000625006011	BB
				6305	000625006305	BB
Compressor de ar (dianteiro) / Compresor de aire (delantero) / Air compressor (front)				NJ 305 FM / C3	005412400004	CRB
				NUP 206 FM	005412400004	CRB
Compressor - árvore / Compresor - eje de la turbina / Compressor shaft turbine			LP/LPK/LPS-1520	6305		BB
Dínamo Bosch (dianteiro) / Dinamo bosch (delantero) / Bosch dynamo (front)			LP/LPK/LPS-1520	6204		BB
Dínamo Bosch (traseiro) / Dinamo bosch (trasero) / Bosch dynamo (rear)			LP/LPK/LPS-1520	6004		BB
Polia tensora (dianteiro) / Polea tensora (delantero) / Tensioner pulley (front)				30205 F	000720030205	TRB
Polia tensora (traseiro) / Polea tensora (trasero) / Tensioner pulley (rear)				30204 F	000720030204	TRB
Ventilador (dianteiro) / Ventilador (delantero) / Fan (front)				30205 F	000720030205	TRB
Ventilador (traseiro) / Ventilador (trasero) / Fan (rear)				30204 F	000720030204	TRB
Virabrequim - ponta / Cigüeñal - punta / Crankshaft spindle			OM 352 A * OM 355 * OM 366 A/LA * OM 352	6204 2RS		BB
			OM 355 A/5-I	6205 2RS		BB

1517 OF * 1518 OF * 1520 OF

Caixa de Mudanças / Caja de Cambios / Gearbox

Eixo de entrada / Eje de entrada / Input shaft				6209 C3	000625036209	BB
			718052	6209 C3		BB

	OUT	IN		Fersa®	Nº OEM	
---	-----	----	---	---------------	--------	---

MERCEDES BENZ (SA)

1517 OF * 1518 OF * 1520 OF

Caixa de Mudanças / Caja de Cambios / Gearbox



Eixo de saída (traseiro) / Eje de salida (trasero) / Output shaft (rear)				6007 N	000625506007	BB
				6208 N	000625506208	BB
Eixo intermediário / Eje intermedio / Intermediate shaft				6208 N	000625506208	BB
Eixo intermediário (dianteiro) / Eje intermedio (delantero) / Intermediate shaft (front)				33885 / 33822	0019809602	TRB
Eixo Intermediário (dianteiro/traseiro) / Eje Intermedio (delantero/trasero) / Intermediate shaft (front/rear)				30308 F	0019813105 / 0019815005	TRB
				33889 / 33822	0019809502	TRB
Eixo primário / Eje primario / Primary shaft				6208 N	000625506208	BB
		AK 6-80/9,0		NUP 314 FMNR / C3		CRB
Eixo primário (dianteiro) / Eje primario (delantero) / Primary shaft (front)				QJ 209 FM	3459817027	BB4PAC
				QJ 212 FM	3459817627	BB4PAC
Eixo primário (traseiro) / Eje primario (trasero) / Primary shaft (rear)			3/60-5/6,1 * G 3/61-5/6,1 * G 3/50-5/8,5 * G 3/60-5/7,5 * AK 6-80/9,0 * AK 6-80/9,0 GV 80 * G 3/60-5/7,5 + NA 3/60-1B * G 3/60-5/8	F 19011		CRBS
				NU 209 FMN	3449817101	CRB
Eixo secundário / Eje secundario / Secondary shaft				F 19019	0049815801	CRBS
Eixo secundário (interm.) / Eje secundario (interm.) / Secondary shaft (interm.)		LP/LPK/LPS-1520		NUP 314 FM		CRB
Eixo secundário (traseiro) / Eje secundario (trasero) / Secondary shaft (rear)		LP/LPK/LPS-1520		6314		BB
				6314 N / C3	00198190 (77...)25	BB
			G 3/60-5/6,1 * G 3/36-5/8,98 * G 3/40-5/7,5 * G 3/61-5/6,1 * G 3/50-5/8,5 * G 3/60-5/7,5 * AK 6-80/9,0 * AK 6-80/9,0 GV 80 * G 3/60-5/7,5 + NA 3/60-1B	QJ 309 FM		BB4PAC
				QJ 309 FM	3459817127 / 3459817727	BB4PAC
Motora traseira / Motor trasero / Rear engine				NUP 314 FM / C3	0019809802	CRB

Cardan / Cardan / Cardan

Suporte / Soporte / Support				6210	000625006210	BB
		LP/LPK/LPS-1520		6210		BB

Eixo Traseiro / Eje Trasero / Rear Axle

Diferencial - coroa lateral (dir./esq.) / Diferencial - corona lateral (der./izq.) / Differential - crown gear (right/left)			HL 4/01 D-10/38:8 * HL 4/01 D-10 * HL4/01 D-10/ 48:7 * HH 4/05 D-10/43:10	32018 XF		TRB
			HL 5/2 D-10/39:8 * HL 5/2 DZ-10/48:7 * HL 5/2 D-10/45:8 * HL 5/2-10/39:8	32020 XF		TRB
			HH 4/12-10/40:7 * HL 4/27 D-10/43:7 * HH 4/12-10/40:7 * HH 4/12-10/40:7	47487 / 47420 A		TRB
Diferencial - pinhão (dianteiro) / Diferencial - piñón (delantero) / Differential - pinion (front)		LP/LPK/LPS-1520		HM 807046 / HM 807010		TRB
Diferencial - pinhão apoio / Diferencial - piñón apoyo / Differential - support pinion				F 15083	003981190 (77...)5	STRB
Diferencial - pinhão (dianteiro) / Diferencial - piñón (delantero) / Differential - pinion (front)				HM 807046 / HM 807010	031981190 (77...)5	TRB
				F 15183	0069811705	TRBS

	OUT	IN		Fersa®	N° OEM	
---	-----	----	---	---------------	--------	---

MERCEDES BENZ (SA)

1517 OF * 1518 OF * 1520 OF

Eixo Traseiro / Eje Trasero / Rear Axle

Diferencial - pinhão (traseiro) / Diferencial - piñón (trasero) / Differential - pinion (rear)			HL 5/2D-10/39:8 * HL 5/2DZ-10/48:7 * HL 5/2D-10/45:8 * HL 5/2-10/39:8	F 15083	0069811705	STRB
--	--	--	--	----------------	------------	------

Direção / Dirección / Steering

Direção hidráulica - árvore artic. (sup.) / Dirección hidráulica - árbol artic. (sup.) / Hydraulic direction - artic. shaft (upper)			LP/LPK/LPS-1520	6007		BB
---	--	--	-----------------	-------------	--	----

Eixo Dianteiro / Eje Delantero / Front Axle

Roda / Rueda / Wheel		•	LP/LPK/LPS-1520	30313 F		TRB
		•		32307 F	0039816405	TRB
		•	LP/LPK/LPS-1520	32309 F		TRB
		•		33208 F	3849817605 / 0089810105	TRB
		•		33213 F	0089810005	TRB
		•		559 / 552 A	3449817005	TRB

Eixo Traseiro / Eje Trasero / Rear Axle

Roda / Rueda / Wheel	•			32216 F	0009817205	TRB
		•		32218 F	000720032218	TRB
		•		33019 F	00298190 (77...)/05 / 0039818605	TRB
		•		33020 F	0059818505	TRB
		•		33117 F	0059818605	TRB
		•		33215 F	0029818905 / 0029818605	TRB
				497 / 492 A	0009816105	TRB
				498 / 492 A	0039812005	TRB
		•	LP/LPK/LPS-1520	580 / 572		TRB
		•		598 A / 593 X	0039811405	TRB
				H 715345 / H 715311	0319811805	TRB

Embreagem / Embrague / Clutch

Apoio / Apoyo / Support			344938/955/963	6204 2RS		BB
				6204 2RS / C3	000625406204	BB
				6205 2RS	000625406205	BB

Motor / Motor / Engine

Alternador (dianteiro) / Alternador (delantero) / Alternator (front)				6303 2RS / C3	000625406303 / 000625900193	BB
				6303 RS / C3	000625900182	BB
Alternador (dianteiro/traseiro) / Alternador (delantero/traseiro) / Alternator (front/rear)				6403 2RS / C3	0049812425 / 0049811825	BB
Alternador (traseiro) / Alternador (trasero) / Alternator (rear)				6201 2RS / C3	0089810705	BB
				6201 RS / C3	0049812425	BB
				6204 2RS / C3	000625406204	BB
				6205 2RS	000625406205	BB
				62201 2RS / C3	00298190 (77...)/25	BB
				6403 2RS / C3		BB
Bomba d'água (dianteiro) / Bomba de agua (delantero) / Water pump (front)				6204	000625006204	BB

	OUT	IN		Fersa [®]	Nº OEM	
---	-----	----	---	---------------------------	--------	---

MERCEDES BENZ (SA)

1517 OF * 1518 OF * 1520 OF

Motor / Motor / Engine

Bomba d'água (dianteiro/traseiro) / Bomba de agua (delantero/trasero) / Water pump (front/rear)				6203 C3	000625900208	BB
Bomba d'água (traseiro) / Bomba de agua (trasero) / Water pump (rear)				6004	000625006004	BB
			OM 366 A/LA	6203 C3		BB
				6206 C3	000625900209	BB
				NU 303 FM	0019819601	CRB
Bomba hidráulica / Bomba hidráulica / Hydraulic pump				62204 2RS	0049819625	BB
Bomba injetora (dianteiro) / Bomba inyectora (delantero) / Injection pump (front)				6305	000625006305	BB
				30203 F	000720030203	TRB
				32205 F	000720032205	TRB
Bomba injetora (dianteiro/traseiro) / Bomba inyectora (delantero/trasero) / Injection pump (front/rear)			OM 355/5A	32205 BF		TRB
Bomba injetora (traseiro) / Bomba inyectora (trasero) / Injection pump (rear)				6205	000625006205	BB
				30205 F	000720030205	TRB
Compressor / Compresor / Compressor			LP-1520	6011		BB
Compressor (dianteiro) / Compresor (delantero) / Compressor (front)			OM 355/5A	NJ 305 C3		CRB
Compressor de ar / Compresor de aire / Air compressor				6011	000625006011	BB
				6305	000625006305	BB
Compressor de ar (dianteiro) / Compresor de aire (delantero) / Air compressor (front)				NJ 305 FM / C3	005412400004	CRB
				NUP 206 FM	005412400004	CRB
Compressor - árvore / Compresor - eje de la turbina / Compressor shaft turbine			LP/LPK/LPS-1520	6305		BB
Dinamo Bosch (dianteiro) / Dinamo bosch (delantero) / Bosch dynamo (front)			LP/LPK/LPS-1520	6204		BB
Dinamo Bosch (traseiro) / Dinamo bosch (trasero) / Bosch dynamo (rear)			LP/LPK/LPS-1520	6004		BB
Polia tensora (dianteiro) / Polea tensora (delantero) / Tensioner pulley (front)				30205 F	000720030205	TRB
Polia tensora (traseiro) / Polea tensora (trasero) / Tensioner pulley (rear)				30204 F	000720030204	TRB
Ventilador (dianteiro) / Ventilador (delantero) / Fan (front)				30205 F	000720030205	TRB
Ventilador (traseiro) / Ventilador (trasero) / Fan (rear)				30204 F	000720030204	TRB
Virabrequim - ponta / Cigüeñal - punta / Crankshaft spindle			OM 352 A * OM 355 * OM 366 A/LA * OM 352	6204 2RS		BB
Virabrequim - ponta / Cigüeñal - punta / Crankshaft spindle			OM 355 A/5-I	6205 2RS		BB

1614 * 1615 (L*LK*LS) * 1615 * 1618 M * 1618 (L*LK*LS) * 1619 (L)

Caixa de Mudanças / Caja de Cambios / Gearbox

Eixo de acionamento / Eje de accionamiento / Drive shaft				NUP 2212 FMN		CRB
				NUP 310 FMN / C3		CRB
Eixo intermediário (dianteiro) / Eje intermedio (delantero) / Intermediate shaft (front)				33885 / 33822	0019809602	TRB
			S 6-90/9,01 * 16 S-130 * S 6-90/9,01 + N 70/18 * S 6-90/6,98 * 8 S-1350 * S 6-1550/6,98 * S 6-1550 * S 6-105	F 15047		STRB
Eixo Intermediário (dianteiro/traseiro) / Eje Intermedio (delantero/trasero) / Intermediate shaft (front/rear)				30308 F	0019813105 / 0019815005	TRB



	OUT	IN		Fersa®	N° OEM	
---	-----	----	---	---------------	--------	---

MERCEDES BENZ (SA)

1614 * 1615 (L*LK*LS) * 1615 * 1618 M * 1618 (L*LK*LS) * 1619 (L)

Caixa de Mudanças / Caja de Cambios / Gearbox

Eixo Intermediário (dianteiro/traseiro) / Eje Intermedio (delantero/trasero) / Intermediate shaft (front/rear)				33889 / 33822	0019809502	TRB
			G 3/60-5/7,5 * G 3/50-5/8,5 * G 3/55-6/8,5 * G 3/50-5/8,5 * G 3/60-5/7,5 + NA 3/60-1B * G 3/50-5/8,5 + NA 3/60-1B * 16 S-1650 * S 6-1550/6.98 + ESI	30308 F		TRB
Eixo intermediário (saída) / Eje intermedio (salida) / Intermediate shaft (output)				32309 F		TRB
Eixo intermediário (traseiro) / Eje intermedio (trasero) / Intermediate shaft (rear)				30309 F	00198113705	TRB
			S 6-90/9,01 * S 6-90/9,0 + N 70/18 * S 6-90/6,98 * S 6-1550/6,98 * S 6-1550 * S 6-105 * S 6-1550/6.98 + ESI	32309 F		TRB
			16 S-130 * 8 S-1350 * 16 S-1650	32310 F		TRB
Eixo primário / Eje primario / Primary shaft			S 6-90/9,0 + N 70/18 (ZF)	6208 N		BB
			G 3/50-5/8,5	F 19047		CRBS
			S 6-90/9:01 (ZF) * S 6-1550/ 6,98 * S 6-90/6,98 * S 6-1550 *	NUP 314 FMNR / C3		CRB
				6208 N	000625506208	BB
				NUP 314 FM / C3	0019819802	CRB
Eixo primário (dianteiro) / Eje primario (delantero) / Primary shaft (front)			G 3/60-5/7,5 * G 3/50-5/8,5 * G 3/60-5/7,5 + NA 3/60-1B * G 3/50-5/8,5 + NA 3/60-1B	QJ 212 FM		BB4PAC
				QJ 212 FM	3459817627	BB4PAC
Eixo primário (traseiro) / Eje primario (trasero) / Primary shaft (rear)			G 3/60-5/7,5 * G 3/50-5/8,5 * G 3/60-5/7,5 + NA 3/60-1B * G 3/50-5/8,5 + NA 3/60-1B	F 19011		CRBS
				NU 209 FMN	0019811701	CRB
Eixo principal (saída) / Eje principal (salida) / Main shaft (output)				NUP 310 FMN / C3		CRB
Eixo secundário / Eje secundario / Secondary shaft				F 19019	0049815801	CRBS
			4 S-120 GP * 4 S-120 GP + N 70/18	NUP 311 FMNR / C3		CRB
Eixo secundário (traseiro) / Eje secundario (trasero) / Secondary shaft (rear)			S 6-1550/6,98 * S 6-90/6,98	6314 C3		BB
			G 3/55-6/8,5	F 19046		CRBS
			S 6-1550 * S 6-105 * S 6-1550/6.98 + ESI	NUP 314 FMNR / C3		CRB
			G 3/60-5/7,5 * G 3/50-5/8,5 * G 3/60-5/7,5 + NA 3/60-1B *	QJ 309 FM		BB4PAC
				QJ 309 FM	3459817127 / 3459817727	BB4PAC
Tampa (traseiro) / Cubierta (trasero) / Cover (rear)			16 S-130 * 8 S-1350 * 16 S-1650	6218 C3		BB
Tomada de força / Toma de fuerza / Power take-off				6208 N		BB
Cardan / Cardan / Cardan						
Suporte / Soporte / Support				6210	000625006210	BB

	OUT	IN		Fersa®	N° OEM	
---	-----	----	---	---------------	--------	---

MERCEDES BENZ (SA)

1614 * 1615 (L*LK*LS) * 1615 * 1618 M * 1618 (L*LK*LS) * 1619 (L)

Eixo Traseiro / Eje Trasero / Rear Axle

Diferencial - coroa lateral (dir./esq.) / Diferencial - corona lateral (der./izq.) / Differential - crown gear (right/left)			HL 4/01 D-10/43:10 * HL 4/01 D-10/43:10 * HL 4/01 D-10/41:7 * HL 4/01 D-10/47:9 * HL 4/01 D-10/43:7 * HH 4/07 DL-1	32018 XF		TRB
			HL 5/2 DZ10:48:7 * HL 5/60 DZ-10 * HL 5/2 DZ-10/43:7 * HL 5/61 DZ-10/39:8 * HL 5/60 DZ-10/39:8 * HL 4/050 DC-11,5 * HL 4/061 D-11,5	32020 XF		TRB
			HL 7/021 D-10/26:24 * HL 7/021 D-10/29:25 * HL 7/021 D-10/3,77 * HL 7/022 D-12,3/3,43 * HL 7/021 D-10/3,83	33115 F		TRB
			HL 4/27 D-10/40:7 * HL 4/27 D-10/39:8 40:7 * HH 4/12-10/40:7	47487 / 47420 A		TRB
Diferencial - pinhão (dianteiro) / Diferencial - piñón (delantero) / Differential - pinion (front)			HL 7/02 D-10/29:25 * HL 7/021 D-10/26:24 * HL 7/021 D-10/3,77 * HL 7/022 D-12,3/3,43 * HL 7/021 D-10/3,83	31313 F		TRB
Diferencial - pinhão (traseiro) / Diferencial - piñón (trasero) / Differential - pinion (rear)			HL 7/021 D-10/29:25 * HL 7/021 D-10/26:24 * HL 7/021 D-10/3,77 * HL 7/022 D-12,3/3,43 * HL 7/021 D-10/3,83	32314 BF		TRB
			HL 5/2 DZ10/48:7 * HL 5/60 DZ-10 * HL 5/2 DZ-10/43:7 * HL 5/61 DZ-10/39:8 * HL 5/60 DZ-10/39:8	F 15083		STRB

Direção / Dirección / Steering

Alavanca intermediária / Palanca intermedia / Intermediate lever			OF-1618/1620	30205 F		TRB
			OF-1618/1620	30206 F		TRB

Eixo Dianteiro / Eje Delantero / Front Axle

Roda / Rueda / Wheel	•		VL 4/37 DL-6,7 * VL 4/37 DL-7,1	32310 F		TRB
		•		32310 F	0019817405	TRB
	•			33208 F	3849817605 / 0089810105	TRB
	•			33210 F	0039818305	TRB
		•		33213 F	0089810005	TRB
		•		33214 F	0039815605 / 0039815205	TRB
	•			F 15051 C	0059813105	STRB

Eixo Traseiro / Eje Trasero / Rear Axle

Roda / Rueda / Wheel	•		HL 7/021 D-10/26:24 * HL 7/021 D-10/3:7	32019 XF		TRB
	•			32019 XF	0029815405	TRB
		•		33019 F	00298190 (77...)05 / 0039818605	TRB
	•			33019 F	00298190 (77...)05 / 0039818605	TRB

	OUT	IN		Fersa®	N° OEM	
---	-----	----	---	---------------	--------	---

MERCEDES BENZ (SA)

1614 * 1615 (L*LK*LS) * 1615 * 1618 M * 1618 (L*LK*LS) * 1619 (L)

Eixo Traseiro / Eje Trasero / Rear Axle

Roda / Rueda / Wheel		•		33020 F	0059818505	TRB
		•		33020 F	014 981 3205	TRB
		•		33021 F	0039812605	TRB
	•			33116 F	012 981 4005	TRB
	•			33117 F	0059818605	TRB
	•			33215 F	0029818905 / 0029818605	TRB

Motor / Motor / Engine

Alternador (dianteiro) / Alternador (delantero) / Alternator (front)				6303 2RS / C3	000625406303 / 000625900193	BB
				6303 RS / C3	000625900182	BB
				6403 C3	0049812425	BB
Alternador (traseiro) / Alternador (trasero) / Alternator (rear)				62201 2RS / C3	00298190 (77...)95	BB
Bomba d'água (dianteiro) / Bomba de agua (delantero) / Water pump (front)				30204 F	000720030204	TRB
				6206 C3	000625900209	BB
Bomba d'água (traseiro) / Bomba de agua (trasero) / Water pump (rear)				6203 C3	000625900208	BB
Bomba hidráulica / Bomba hidráulica / Hydraulic pump				62204 2RS	0049819625	BB
Bomba injetora (dianteiro) / Bomba inyectora (delantero) / Injection pump (front)				30203 F	000720030203	TRB
Bomba injetora (traseiro) / Bomba inyectora (trasero) / Injection pump (rear)				30204 F	000720030204	TRB
Virabrequim / Cigüeñal / Crankshaft				6204 2RS / C3	000625406204	BB
Tomada de Potência / Toma de Potencia / Power Take-off						
Eixo de saída (traseiro) / Eje de salida (trasero) / Output shaft (rear)				6007 N	000625506007	BB
				6208 N	000625506208	BB
Eixo intermediário / Eje intermedio / Intermediate shaft				6209 C3	000625036209	BB

1618 (OF)

Caixa de Mudanças / Caja de Cambios / Gearbox

Eixo de acionamento / Eje de accionamiento / Drive shaft				NUP 2212 FMN		CRB
				NUP 310 FMN / C3		CRB
Eixo intermediário (dianteiro) / Eje intermedio (delantero) / Intermediate shaft (front)				33885 / 33822	0019809602	TRB
			S 6-90/9,01 * 16 S-130 * S 6-90/9,01 + N 70/18 * S 6-90/6,98 * 8 S-1350 * S 6-1550/6,98 * S 6-1550 * S 6-105	F 15047		STRB
Eixo Intermediário (dianteiro/traseiro) / Eje Intermedio (delantero/trasero) / Intermediate shaft (front/rear)				30308 F	0019813105 / 0019815005	TRB
				33889 / 33822	0019809502	TRB
			G 3/60-5/7,5 * G 3/50-5/8,5 * G 3/55-6/8,5 * G 3/50-5/8,5 * G 3/60-5/7,5 + NA 3/60-1B * G 3/50-5/8,5 + NA 3/60-1B * 16 S-1650 * S 6-1550/6.98 + ESI	30308 F		TRB
Eixo intermediário (saída) / Eje intermedio (salida) / Intermediate shaft (output)				32309 F		TRB
Eixo intermediário (traseiro) / Eje intermedio (trasero) / Intermediate shaft (rear)				30309 F	00198113705	TRB

	OUT	IN		Fersa®	Nº OEM	
---	-----	----	---	---------------	--------	---

MERCEDES BENZ (SA)

1618 (OF)

Caixa de Mudanças / Caja de Cambios / Gearbox

Eixo intermediário (traseiro) / Eje intermedio (trasero) / Intermediate shaft (rear)		S 6-90/9,01 * S 6-90/9,0 + N 70/18 * S 6-90/6,98 * S 6-1550/6,98 * S 6-1550 * S 6-105 * S 6-1550/6,98 + ESI	32309 F		TRB
		16 S-130 * 8 S-1350 * 16 S-1650	32310 F		TRB
Eixo primário / Eje primario / Primary shaft		S 6-90/9,0 + N 70/18 (ZF)	6208 N		BB
		G 3/50-5/8,5	F 19047		CRBS
		S 6-90/9:01 (ZF) * S 6-1550/ 6,98 * S 6-90/6,98 * S 6-1550 *	NUP 314 FMNR / C3		CRB
			6208 N	000625506208	BB
			NUP 314 FM / C3	0019819802	CRB
Eixo primário (dianteiro) / Eje primario (delantero) / Primary shaft (front)		G 3/60-5/7,5 * G 3/50-5/8,5 * G 3/60-5/7,5 + NA 3/60-1B * G 3/50-5/8,5 + NA 3/60-1B	QJ 212 FM		BB4PAC
			QJ 212 FM	3459817627	BB4PAC
Eixo primário (traseiro) / Eje primario (trasero) / Primary shaft (rear)		G 3/60-5/7,5 * G 3/50-5/8,5 * G 3/60-5/7,5 + NA 3/60-1B * G 3/50-5/8,5 + NA 3/60-1B	F 19011		CRBS
			NU 209 FMN	0019811701	CRB
Eixo principal (saída) / Eje principal (salida) / Main shaft (output)			NUP 310 FMN / C3		CRB
Eixo secundário / Eje secundario / Secondary shaft			F 19019	0049815801	CRBS
		4 S-120 GP * 4 S-120 GP + N 70/18	NUP 311 FMNR / C3		CRB
Eixo secundário (traseiro) / Eje secundario (trasero) / Secondary shaft (rear)		S 6-1550/6,98 * S 6-90/6,98	6314 C3		BB
		G 3/55-6/8,5	F 19046		CRBS
		S 6-1550 * S 6-105 * S 6-1550/6,98 + ESI	NUP 314 FMNR / C3		CRB
		G 3/60-5/7,5 * G 3/50-5/8,5 * G 3/60-5/7,5 + NA 3/60-1B *	QJ 309 FM		BB4PAC
			QJ 309 FM	3459817127 / 3459817727	BB4PAC
Tampa (traseiro) / Cubierta (trasero) / Cover (rear)		16 S-130 * 8 S-1350 * 16 S-1650	6218 C3		BB
Tomada de força / Toma de fuerza / Power take-off			6208 N		BB

Cardan / Cardan / Cardan

Suporte / Soporte / Support			6210	000625006210	BB
-----------------------------	--	--	-------------	--------------	----

Eixo Traseiro / Eje Trasero / Rear Axle

Diferencial - coroa lateral (dir./esq.) / Diferencial - corona lateral (der./izq.) / Differential - crown gear (right/left)		HL 4/01 D-10/43:10 * HL 4/01 D-10/43:10 * HL 4/01 D-10/41:7 * HL 4/01 D-10/47:9 * HL 4/01 D-10/43:7 * HH 4/07 DL-1	32018 XF		TRB
		HL 5/2 DZ10:48:7 * HL 5/60 DZ-10 * HL 5/2 DZ-10/43:7 * HL 5/61 DZ-10/39:8 * HL 5/60 DZ-10/39:8 * HL 4/050 DC-11,5 * HL 4/061 D-11,5	32020 XF		TRB



OUT

IN



Fersa®

N° OEM



MERCEDES BENZ (SA)

1618 (OF)

Eixo Traseiro / Eje Trasero / Rear Axle

Diferencial - coroa lateral (dir./esq.) / Diferencial - corona lateral (der./izq.) / Differential - crown gear (right) / (left)			HL 7/021 D-10/26:24 * HL 7/021 D-10/29:25 * HL 7/021 D-10/3,77 * HL 7/022 D-12,3/3,43 * HL 7/021 D-10/3,83	33115 F		TRB
			HL 4/27 D-10/40:7 * HL 4/27 D-10/39:8 40:7 * HH 4/12-10/40:7	47487 / 47420 A		TRB
Diferencial - pinhão (dianteiro) / Diferencial - piñón (delantero) / Differential - pinion (front)			HL 7/02 D-10/29:25 * HL 7/021 D-10/26:24 * HL 7/021 D-10/3,77 * HL 7/022 D-12,3/3,43 * HL 7/021 D-10/3,83	31313 F		TRB
				F 15183	0069811705	TRBS
Diferencial - pinhão (traseiro) / Diferencial - piñón (traseiro) / Differential - pinion (rear)			HL 7/021 D-10/29:25 * HL 7/021 D-10/26:24 * HL 7/021 D-10/3,77 * HL 7/022 D-12,3/3,43 * HL 7/021 D-10/3,83	32314 BF		TRB
			HL 5/2 DZ10/48:7 * HL 5/60 DZ-10 * HL 5/2 DZ-10/43:7 * HL 5/61 DZ-10/39:8 * HL 5/60 DZ-10/39:8	F 15083	0069811705	TRBS

Direção / Dirección / Steering



Alavanca intermediária / Palanca intermedia / Intermediate lever			OF-1618/1620	30205 F		TRB
			OF-1618/1620	30206 F		TRB

Eixo Dianteiro / Eje Delantero / Front Axle

Roda / Rueda / Wheel	•		VL 4/37 DL-6,7 * VL 4/37 DL-7,1	32310 F		TRB
		•		32310 F	0019817405	TRB
	•			33208 F	3849817605 / 0089810105	TRB
	•			33210 F	0039818305	TRB
		•		33213 F	0089810005	TRB
		•		33214 F	0039815605 / 0039815205	TRB
	•			F 15051 C	0059813105	STRB

Eixo Traseiro / Eje Trasero / Rear Axle

Roda / Rueda / Wheel	•		HL 7/021 D-10/26:24 * HL 7/021 D-10/3:7	32019 XF		TRB
	•			32019 XF	0029815405	TRB
		•		33019 F	00298190 (77...)05 / 0039818605	TRB
	•			33019 F	00298190 (77...)05 / 0039818605	TRB
		•		33020 F	0059818505	TRB
		•		33020 F	014 981 3205	TRB
		•		33021 F	0039812605	TRB
	•			33116 F	012 981 4005	TRB
	•			33117 F	0059818605	TRB
	•			33215 F	0029818905 / 0029818605	TRB

	OUT	IN		Fersa®	Nº OEM	
---	-----	----	---	---------------	--------	---

MERCEDES BENZ (SA)

1618 (OF)

Motor / Motor / Engine

Alternador (dianteiro) / Alternador (delantero) / Alternator (front)				6303 2RS / C3	000625406303 / 000625900193	BB
				6303 RS / C3	000625900182	BB
				6403 C3	0049812425	BB
Alternador (traseiro) / Alternador (trasero) / Alternator (rear)				62201 2RS / C3	00298190 (77...)95	BB
Bomba d'água (dianteiro) / Bomba de agua (delantero) / Water pump (front)				30204 F	000720030204	TRB
				6206 C3	000625900209	BB
Bomba d'água (traseiro) / Bomba de agua (trasero) / Water pump (rear)				6203 C3	000625900208	BB
Bomba hidráulica / Bomba hidráulica / Hydraulic pump				62204 2RS	0049819625	BB
Bomba injetora (dianteiro) / Bomba inyectora (delantero) / Injection pump (front)				30203 F	000720030203	TRB
Bomba injetora (traseiro) / Bomba inyectora (trasero) / Injection pump (rear)				30204 F	000720030204	TRB
Virabrequim / Cigüeñal / Crankshaft				6204 2RS / C3	000625406204	BB

Tomada de Potência / Toma de Potencia / Power Take-off

Eixo de saída (traseiro) / Eje de salida (trasero) / Output shaft (rear)				6007 N	000625506007	BB
				6208 N	000625506208	BB
Eixo intermediário / Eje intermedio / Intermediate shaft				6209 C3	000625036209	BB

1620 (L*LK*LS) * 1620 6X2 51 (L) * 1621 (L*LK*LS) * 1622 (L*LK*LS) * 1623 (L*LS) * 1625 (L*LK*LS) * 1630 (L*LK*LS) *
 1632 (L*LS) * 1633 (L*LK*LS) * 1634 (L*LS) * 1635 L

Caixa de Mudanças / Caja de Cambios / Gearbox

Eixo intermediário (dianteiro) / Eje intermedio (delantero) / Intermediate shaft (front)			S 6-90/9,01 * 16 S-130 * S 6-90/9,01 + N 70/18 * S 6-90/6,98 * 8 S-1350 * S 6-1550/6,98 * S 6-1550 * S 6-105	F 15047		STRB
Eixo Intermediário (dianteiro/traseiro) / Eje Intermedio (delantero/trasero) / Intermediate shaft (front/rear)			G 3/60-5/7,5 * G 3/50-5/8,5 * G 3/55-6/8,5 * G 3/50-5/8,5 * G 3/60-5/7,5 + NA 3/60-1B * G 3/50-5/8,5 + NA 3/60-1B * 16 S-1650 * S 6-1550/6,98 + ESI	30308 F		TRB
Eixo intermediário (traseiro) / Eje intermedio (trasero) / Intermediate shaft (rear)			S 6-90/9,01 * S 6-90/9,0 + N 70/18 * S 6-90/6,98 * S 6-1550/6,98 * S 6-1550 * S 6-105 * S 6-1550/6,98 + ESI	32309 F		TRB
			16 S-130 * 8 S-1350 * 16 S-1650	32310 F		TRB
Eixo primário / Eje primario / Primary shaft			S 6-90/9,0 + N 70/18 (ZF)	6208 N		BB
			G 3/50-5/8,5	F 19047		CRBS
			S 6-90/9,01 (ZF) * S 6-1550/ 6,98 * S 6-90/6,98 * S 6-1550 *	NUP 314 FMNR / C3		CRB
Eixo primário (dianteiro) / Eje primario (delantero) / Primary shaft (front)			G 3/60-5/7,5 * G 3/50-5/8,5 * G 3/60-5/7,5 + NA 3/60-1B * G 3/50-5/8,5 + NA 3/60-1B	QJ 212 FM		BB4PAC
Eixo primário (traseiro) / Eje primario (trasero) / Primary shaft (rear)			G 3/60-5/7,5 * G 3/50-5/8,5 * G 3/60-5/7,5 + NA 3/60-1B * G 3/50-5/8,5 + NA 3/60-1B	F 19011		CRBS
Eixo secundário / Eje secundario / Secondary shaft			4 S-120 GP * 4 S-120 GP + N 70/18	NUP 311 FMNR / C3		CRB

	OUT	IN		Fersa®	Nº OEM	
---	-----	----	---	---------------	--------	---

MERCEDES BENZ (SA)

1620 (L*LK*LS) * 1620 6X2 51 (L) * 1621 (L*LK*LS) * 1622 (L*LK*LS) * 1623 (L*LS) * 1625 (L*LK*LS) * 1630 (L*LK*LS) * 1632 (L*LS) * 1633 (L*LK*LS) * 1634 (L*LS) * 1635 L

Caixa de Mudanças / Caja de Cambios / Gearbox

Eixo secundário (traseiro) / Eje secundario (trasero) / Secondary shaft (rear)		S 6-1550/6,98 * S 6-90/6,98	6314 C3	BB
		G 3/55-6/8,5	F 19046	CRBS
		S 6-1550 * S 6-105 * S 6-1550/6.98 + ESI	NUP 314 FMNR / C3	CRB
		G 3/60-5/7,5 * G 3/50-5/8,5 * G 3/60-5/7,5 + NA 3/60-1B *	QJ 309 FM	BB4PAC
Tampa (traseiro) / Cubierta (trasero) / Cover (rear)		16 S-130 * 8 S-1350 * 16 S-1650	6218 C3	BB

Cardan / Cardan / Cardan

Suporte / Soporte / Support		L-1614	6210	BB
-----------------------------	--	--------	-------------	----

Eixo Traseiro / Eje Trasero / Rear Axle

Diferencial - coroa lateral (dir./esq.) / Diferencial - corona lateral (der./izq.) / Differential - crown gear (right/left)		HL 4/01 D-10/43:10 * HL 4/01 D-10/43:10 * HL 4/01 D-10/41:7 * HL 4/01 D-10/47:9 * HL 4/01 D-10/43:7 * HH 4/07 DL-1	32018 XF	TRB
		HL 5/2 DZ10:48:7 * HL 5/60 DZ-10 * HL 5/2 DZ-10/43:7 * HL 5/61 DZ-10/39:8 * HL 5/60 DZ-10/39:8 * HL 4/050 DC-11,5 * HL 4/061 D-11,5	32020 XF	TRB
		HL 7/021 D-10/26:24 * HL 7/021 D-10/29:25 * HL 7/021 D-10/3,77 * HL 7/022 D-12,3/3,43 * HL 7/021 D-10/3,83	33115 F	TRB
		HL 4/27 D-10/40:7 * HL 4/27 D-10/39:8 40:7 * HH 4/12-10/40:7	47487 / 47420 A	TRB
Diferencial - pinhão (dianteiro) / Diferencial - piñón (delantero) / Differential - pinion (front)		HL 7/02 D-10/29:25 * HL 7/021 D-10/26:24 * HL 7/021 D-10/3,77 * HL 7/022 D-12,3/3,43 * HL 7/021 D-10/3,83	31313 F	TRB
Diferencial - pinhão (traseiro) / Diferencial - piñón (trasero) / Differential - pinion (rear)		HL 7/021 D-10/29:25 * HL 7/021 D-10/26:24 * HL 7/021 D-10/3,77 * HL 7/022 D-12,3/3,43 * HL 7/021 D-10/3,83	32314 BF	TRB
		HL 5/2 DZ10:48:7 * HL 5/60 DZ-10 * HL 5/2 DZ-10/43:7 * HL 5/61 DZ-10/39:8 * HL 5/60 DZ-10/39:8	F 15083	STRB

Direção / Dirección / Steering

Alavanca intermediária / Palanca intermedia / Intermediate lever		OF-1618/1620	30205 F	TRB
		OF-1618/1620	30206 F	TRB

Motor / Motor / Engine

Alternador (dianteiro) / Alternador (delantero) / Alternator (front)		OM 366 A/LA * OM 449 A/LA	6303 2RS / C3	BB
		OM 449 A * OM 366 * OM 366 A * OM 366 LA II/23	6403 2RS / C3	BB

	OUT	IN		Fersa®	Nº OEM	
---	-----	----	---	---------------	--------	---

MERCEDES BENZ (SA)

1620(L*LK*LS) * 1620 6X2 51 (L) * 1621 (L*LK*LS) * 1622 (L*LK*LS) * 1623 (L*LS) * 1625 (L*LK*LS) * 1630 (L*LK*LS) * 1632 (L*LS) * 1633 (L*LK*LS) * 1634 (L*LS) * 1635 L

Motor / Motor / Engine

Alternador (traseiro) / Alternador (trasero) / Alternator (rear)		OM 449 A/LA * OM 366 A/LA (28V * 35A/28 A * 14V * 55 A-Bosch) * OM 366 LA II/23	62201 2RS / C3		BB
Bomba d'água (dianteiro) / Bomba de agua (delantero) / Water pump (front)		OM 366 * OM 366 A/LA * OM 366 LAG	6206 C3		BB
Bomba d'água (traseiro) / Bomba de agua (trasero) / Water pump (rear)		OM 366 * OM 366 A/LA * M 366 LAG	6203 C3		BB
Vírbrequim - ponta / Cigüeñal - punta / Crankshaft spindle		OM 366 A/LA * M 366 LAG	6204 2RS		BB

Tomada de Força / Toma de Fuerza / Power Take-off

Eixo de saída (traseiro) / Eje de salida (trasero) / Output shaft (rear)		G 3/60-5/7,5 + NA 3/60-1B * G 3/50-5/8,5 + NA 3/60-1B	6007 N		BB
		S 6-90/9,0 + N 70/18	6208 N		BB
Eixo intermediário / Eje intermedio / Intermediate shaft		4 S-120 GP + N 70/18	6209 C3		BB

1620 OF * 1621 OF

Caixa de Mudanças / Caja de Cambios / Gearbox

Eixo intermediário (dianteiro) / Eje intermedio (delantero) / Intermediate shaft (front)		S 6-90/9:01 * 16 S-130 * S 6-90/9,01 + N 70/18 * S 6-90/6,98 * 8 S-1350 * S 6-1550/6,98 * S 6-1550 * S 6-105	F 15047		STRB
Eixo Intermediário (dianteiro/traseiro) / Eje Intermedio (delantero/trasero) / Intermediate shaft (front/rear)		G 3/60-5/7,5 * G 3/50-5/8,5 * G 3/55-6/8,5 * G 3/50-5/8,5 * G 3/60-5/7,5 + NA 3/60-1B * G 3/50-5/8,5 + NA 3/60-1B * 16 S-1650 * S 6-1550/6,98 + ESI	30308 F		TRB
Eixo intermediário (traseiro) / Eje intermedio (trasero) / Intermediate shaft (rear)		S 6-90/9,01 * S 6-90/9,0 + N 70/18 * S 6-90/6,98 * S 6-1550/6,98 * S 6-1550 * S 6-105 * S 6-1550/6,98 + ESI	32309 F		TRB
		16 S-130 * 8 S-1350 * 16 S-1650	32310 F		TRB
Eixo primário / Eje primario / Primary shaft		S 6-90/9,0 + N 70/18 (ZF)	6208 N		BB
		G 3/50-5/8,5	F 19047		CRBS
		S 6-90/9:01 (ZF) * S 6-1550/6,98 * S 6-90/6,98 * S 6-1550 *	NUP 314 FMNR / C3		CRB
Eixo primário (dianteiro) / Eje primario (delantero) / Primary shaft (front)		G 3/60-5/7,5 * G 3/50-5/8,5 * G 3/60-5/7,5 + NA 3/60-1B * G 3/50-5/8,5 + NA 3/60-1B	QJ 212 FM		BB4PAC
Eixo primário (traseiro) / Eje primario (trasero) / Primary shaft (rear)		G 3/60-5/7,5 * G 3/50-5/8,5 * G 3/60-5/7,5 + NA 3/60-1B * G 3/50-5/8,5 + NA 3/60-1B	F 19011		CRBS
Eixo secundário / Eje secundario / Secondary shaft		4 S-120 GP * 4 S-120 GP + N 70/18	NUP 311 FMNR / C3		CRB
Eixo secundário (traseiro) / Eje secundario (trasero) / Secondary shaft (rear)		S 6-1550/6,98 * S 6-90/6,98	6314 C3		BB
		G 3/55-6/8,5	F 19046		CRBS

	OUT	IN		Fersa®	Nº OEM	
---	-----	----	---	---------------	--------	---

MERCEDES BENZ (SA)

1620 OF * 1621 OF

Caixa de Mudanças / Caja de Cambios / Gearbox

Eixo secundário (traseiro) / Eje secundario (trasero) / Secondary shaft (rear)			S 6-1550 * S 6-105 * S 6-1550/6.98 + ESI	NUP 314 FMNR / C3		CRB
			G 3/60-5/7,5 * G 3/50-5/8,5 * G 3/60-5/7,5 + NA 3/60-1B	QJ 309 FM		BB4PAC
Tampa (traseiro) / Cubierta (trasero) / Cover (rear)			16 S-130 * 8 S-1350 * 16 S-1650	6218 C3		BB

Cardan / Cardan / Cardan

Suporte / Soporte / Support			L-1614	6210		BB
-----------------------------	--	--	--------	-------------	--	----

Eixo Traseiro / Eje Trasero / Rear Axle



Diferencial - coroa lateral (dir./esq.) / Diferencial - corona lateral (der./izq.) / Differential - crown gear (right/left)			HL 4/01 D-10/43:10 * HL 4/01 D-10/43:10 * HL 4/01 D-10/41:7 * HL 4/01 D-10/47:9 * HL 4/01 D-10/43:7 * HH 4/07 DL-1	32018 XF		TRB
			HL 5/2 DZ10:48:7 * HL 5/60 DZ-10 * HL 5/2 DZ-10/43:7 * HL 5/61 DZ-10/39:8 * HL 5/60 DZ-10/39:8 * HL 4/050 DC-11,5 * HL 4/061 D-11,5	32020 XF		TRB
			HL 7/021 D-10/26:24 * HL 7/021 D-10/29:25 * HL 7/021 D-10/3,77 * HL 7/022 D-12,3/3,43 * HL 7/021 D-10/3,83	33115 F		TRB
			HL 4/27 D-10/40:7 * HL 4/27 D-10/39:8 40:7 * HH 4/12-10/40:7	47487 / 47420 A		TRB
Diferencial - pinhão (dianteiro) / Diferencial - piñón (delantero) / Differential - pinion (front)			HL 7/02 D-10/29:25 * HL 7/021 D-10/26:24 * HL 7/021 D-10/3,77 * HL 7/022 D-12,3/3,43 * HL 7/021 D-10/3,83	31313 F		TRB
Diferencial - pinhão (traseiro) / Diferencial - piñón (trasero) / Differential - pinion (rear)			HL 7/021 D-10/29:25 * HL 7/021 D-10/26:24 * HL 7/021 D-10/3,77 * HL 7/022 D-12,3/3,43 * HL 7/021 D-10/3,83	32314 BF		TRB
			HL 5/2 DZ10/48:7 * HL 5/60 DZ-10 * HL 5/2 DZ-10/43:7 * HL 5/61 DZ-10/39:8 * HL 5/60 DZ-10/39:8	F 15083		STRB

Direção / Dirección / Steering

Alavanca intermediária / Palanca intermedia / Intermediate lever			OF-1618/1620	30205 F		TRB
			OF-1618/1620	30206 F		TRB

Motor / Motor / Engine

Alternador (dianteiro) / Alternador (delantero) / Alternator (front)			OM 366 A/LA * OM 449 A/LA	6303 2RS / C3		BB
			OM 449 A * OM 366 * OM 366 A * OM 366 LA II/23	6403 2RS / C3		BB
Alternador (traseiro) / Alternador (trasero) / Alternator (rear)			OM 449 A/LA * OM 366 A/LA (28V * 35A/28 A * 14V * 55 A-Bosch) * OM 366 LA II/23	62201 2RS / C3		BB

	OUT	IN		Fersa®	N° OEM	
---	-----	----	---	---------------	--------	---

MERCEDES BENZ (SA)

1620 OF * 1621 OF

Motor / Motor / Engine

Bomba d'água (dianteiro) / Bomba de agua (delantero) / Water pump (front)			OM 366 * OM 366 A/LA * OM 366 LAG	6206 C3		BB
Bomba d'água (traseiro) / Bomba de agua (trasero) / Water pump (rear)			OM 366 * OM 366 A/LA * M 366 LAG	6203 C3		BB
Virabrequim - ponta / Cigüeñal - punta / Crankshaft spindle			OM 366 A/LA * M 366 LAG	6204 2RS		BB

Tomada de Força / Toma de Fuerza / Power Take-off

Eixo de saída (traseiro) / Eje de salida (trasero) / Output shaft (rear)			G 3/60-5/7,5 + NA 3/60-1B * G 3/50-5/8,5 + NA 3/60-1B	6007 N		BB
			S 6-90/9,0 + N 70/18	6208 N		BB
Eixo intermediário / Eje intermedio / Intermediate shaft			4 S-120 GP + N 70/18	6209 C3		BB

1714 OF * 1721 OF * 1722 OF

Caixa de Mudanças / Caja de Cambios / Gearbox

Corpo sincronizador (traseiro) / Cuerpo sincronizador (trasero) / Synchronizer (rear)			4S-120 GP	6213 C3		BB
Eixo de acionamento / Eje de accionamiento / Drive shaft				NUP 2212 FMN		CRB
Eixo de saída (traseiro) / Eje de salida (trasero) / Output shaft (rear)			G 3/50-5/8,5 + NA 3/60-1B * G 3/60-5/7,5 + NA 3/60-1B	6007 N		BB
			S 6-90/9,01 + N 70/1B	6208 N		BB
			S 6-90 * S 6-90/9,01 * S 6-90/9,01 + N 70/1B * 8S-1350	F 15047		STRB
Eixo Intermediário (dianteiro/traseiro) / Eje Intermedio (delantero/trasero) / Intermediate shaft (front/rear)				30308 F	0019813105 / 0019815005	TRB
			G 3/50-5/8,5 + NA 3/60-1B * G 3/60-5/7,5 * G 3/50-5/8,5 * G 3/55-6/8,5 * G 3/60-5/7,5 + NA 3/60-1B	30308 F		TRB
Eixo intermediário (traseiro) / Eje intermedio (trasero) / Intermediate shaft (rear)				32309 F	0049811305	TRB
			8S-1350	32310 F		TRB
			S 6-90/9,01 + N 70/1B	6009 C3		BB
Eixo primário / Eje primario / Primary shaft			G 3/55-6/8,5	F 19047		CRBS
Eixo primário / Eje primario / Primary shaft			S 6-90 * S 6-90/9,01 + N 70/1B	NUP 314 FMNR / C3		CRB
Eixo primário (dianteiro) / Eje primario (delantero) / Primary shaft (front)				QJ 212 FM	3459817627	BB4PAC
Eixo primário (traseiro) / Eje primario (trasero) / Primary shaft (rear)			G 3/50-5/8,5 + NA 3/60-1B * G 3/50-5/8,5	F 19011		CRBS
Eixo principal (saída) / Eje principal (salida) / Main shaft (output)				NUP 310 FMN / C3		CRB
Eixo secundário / Eje secundario / Secondary shaft				F 19019	0049815801	CRBS
Eixo secundário (traseiro) / Eje secundario (trasero) / Secondary shaft (rear)			S 6-90	6314		BB
			S 6-90/9,01 + N 70/1B	6314 C3		BB
			G 3/55-6/8,5	F 19046		CRBS
			4S-120 GP	NUP 311 FMNR / C3		CRB
			G 3/50-5/8,5 + NA 3/60-1B * G 3/60-5/7,5 * G 3/50	QJ 309 FM		BB4PAC
			QJ 309 FM C2	0009813105	BB4PAC	
Tampa (traseiro) / Cubierta (trasero) / Cover (rear)			8S-1350	6218 C3		BB
Tomada de força / Toma de fuerza / Power take-off				6208 N	000625506208	BB

	OUT	IN		Fersa®	N° OEM	
---	-----	----	---	---------------	--------	---

MERCEDES BENZ (SA)

1714 OF * 1721 OF * 1722 OF

Caixa de Mudanças / Caja de Cambios / Gearbox

Eixo Traseiro / Eje Trasero / Rear Axle



Diferencial - coroa lateral (dir./esq.) / Diferencial - corona lateral (der./izq.) / Differential - crown gear (right/left)			HL 4/10 D-10/43:7 * HL 4/10 D-10/41:7 * HL 4/10 D-10/47:9 * HL 4/01 D-10/41:7 * HL 4/01 D-10/43:7 * HL 4/01 D	32018 XF		TRB
			HL 5/2 DZ-10/43:7 * HL 5/2 DZ 10/48:7 * HL 5/60 DZ-10/39:8 * HL 5/60 DZ-10 * HL 5/61 DZ-10/39:8	32020 XF		TRB
			HL 7/021 D-10/3,77	33115 F		TRB
			HL 4/27 D-10/40:7 * HL 4/27 D-10/42:8 * HL 4/27 D-10/43:7 * HL 4/27 D-10/39:8	47487 / 47420 A		TRB
Diferencial - coroa lateral (dir.) / Diferencial - corona lateral (der.) / Differential - crown gear (right)			AL 4/6 DS-6/43:7	47487 / 47420 A		TRB
Diferencial - pinhão (dianteiro) / Diferencial - piñón (delantero) / Differential - pinion (front)			HL 7/021 D-10/3,77	31313 F		TRB
Diferencial - pinhão (traseiro) / Diferencial - piñón (traseiro) / Differential - pinion (rear)			HL 7/021 D-10/3,77	32314 BF		TRB
			HL 5/2 DZ-10/43:7 * HL 5/2 DZ 10/48:7 * HL 5/60 DZ-10/39:8 * HL 5/60 DZ-10 * HL 5/61 DZ-10/39:8	F 15083		STRB

Eixo Dianteiro / Eje Delantero / Front Axle

Roda / Rueda / Wheel	•		AL 4/6 DS-6/43:7	32017 XF		TRB
		•		32310 F	0019817405	TRB
		•	AL 4/6 DS-6/43:7	33019 F		TRB
		•		33208 F	3849817605 / 0089810105	TRB
		•		33210 F	0039818305	TRB
		•	VL 3/7 D-5	33213 F		TRB
		•		33213 F	0089810005	TRB
		•		33214 F	0039815605 / 0039815205	TRB
		•		F 15051 C	0059813105	STRB

Eixo Traseiro / Eje Trasero / Rear Axle

Roda / Rueda / Wheel	•		HL 7/021 D-10/3,77	33019 F		TRB
		•		33019 F	00298190 (77...)05 / 0039818605	TRB
		•		33020 F	0059818505	TRB
		•		33020 F	014 981 3205	TRB
		•	HL 7/021 D-10/3,77	33021 F		TRB
		•		33116 F	012 981 4005	TRB
		•		33117 F	0059818605	TRB
		•		33215 F	0029818905 / 0029818605	TRB

	OUT	IN		Fersa®	N° OEM	
---	-----	----	---	---------------	--------	---

MERCEDES BENZ (SA)

1714 OF * 1721 OF * 1722 OF

Motor / Motor / Engine

Alternador (dianteiro) / Alternador (delantero) / Alternator (front)				6303 ZZ / C3	000625900182	BB
				6303 ZZ / C3	000625900193	BB
			OM 366 * OM 366 A/LA (Bosch 14V 55 A) * OM 366 LA II/23	6403 2RS / C3		BB
Alternador (traseiro) / Alternador (trasero) / Alternator (rear)				62201 2RS / C3	00298190 (77...)95	BB
Bomba d'água (dianteiro) / Bomba de agua (delantero) / Water pump (front)				6206 C3	000625900209	BB
			OM 366 * OM 366 A/LA	6206 C3		BB
Bomba d'água (traseiro) / Bomba de agua (trasero) / Water pump (rear)			OM 366 * OM 366 A/LA	6203 C3		BB
				6203 C3	000625900208	BB
Bomba hidráulica / Bomba hidráulica / Hydraulic pump				62204 2RS	0049819625	BB
Bomba injetora (dianteiro) / Bomba inyectora (delantero) / Injection pump (front)				30203 F	000720030203	TRB
Bomba injetora (traseiro) / Bomba inyectora (trasero) / Injection pump (rear)				30204 F	000720030204	TRB
Virabrequim / Cigüeñal / Crankshaft				6204 2RS / C3	000625406204	BB
Virabrequim - ponta / Cigüeñal - punta / Crankshaft spindle			OM 366 * OM 366 A/LA * OM 366 LA II/23 * OM 449 LA	6204 2RS		BB

Tomada de Potência / Toma de Potencia / Power Take-off

Eixo de saída (traseiro) / Eje de salida (trasero) / Output shaft (rear)				6007 N	000625506007	BB
---	--	--	--	---------------	--------------	----

1714 * 1714 (L*K*LK) * 1715 * 1718 * 1718 (A * AK) * K * 1720 L * 1721 * 1721 S * 1721 (L*LK) * 1722 S * 1723 * 1723 S * 1725 L

Caixa de Mudanças / Caja de Cambios / Gearbox

Corpo sincronizador (traseiro) / Cuerpo sincronizador (trasero) / Synchronizer (rear)			4S-120 GP	6213 C3		BB
Eixo de acionamento / Eje de accionamiento / Drive shaft				NUP 2212 FMN		CRB
Eixo de saída (traseiro) / Eje de salida (trasero) / Output shaft (rear)			G 3/50-5/8,5 + NA 3/60-1B * G 3/60-5/7,5 + NA 3/60-1B	6007 N		BB
			S 6-90/9.01 + N 70/1B	6208 N		BB
Eixo intermediário (dianteiro) / Eje intermedio (delantero) / Intermediate shaft (front)			S 6-90 * S 6-90/9,01 * S 6-90/9.01 + N 70/1B * 8S-1350	F 15047		STRB
Eixo Intermediário (dianteiro/traseiro) / Eje Intermedio (delantero/trasero) / Intermediate shaft (front/rear)				30308 F	0019813105 / 0019815005	TRB
			G 3/50-5/8,5 + NA 3/60-1B * G 3/60-5/7,5 * G 3/50-5/8,5 * G 3/55-6/8,5 * G 3/60-5/7,5 + NA 3/60-1B	30308 F		TRB
Eixo intermediário (traseiro) / Eje intermedio (trasero) / Intermediate shaft (rear)				32309 F	0049811305	TRB
			8S-1350	32310 F		TRB
			S 6-90/9.01 + N 70/1B	6009 C3		BB
Eixo primário / Eje primario / Primary shaft			G 3/55-6/8,5	F 19047		CRBS
			S 6-90 * S 6-90/9.01 + N 70/1B	NUP 314 FMNR / C3		CRB
Eixo primário (dianteiro) / Eje primario (delantero) / Primary shaft (front)				QJ 212 FM	3459817627	BB4PAC
Eixo primário (traseiro) / Eje primario (trasero) / Primary shaft (rear)			G 3/50-5/8,5 + NA 3/60-1B * G 3/50-5/8,5	F 19011		CRBS

	OUT	IN		Fersa®	N° OEM	
---	-----	----	---	---------------	--------	---

MERCEDES BENZ (SA)

1714 * 1714 (L*K*LK) * 1715 * 1718 * 1718 (A * AK) * K * 1720 L * 1721 * 1721 S * 1721 (L*LK) * 1722 S * 1723 * 1723 S * 1725 L

Caixa de Mudanças / Caja de Cambios / Gearbox

Eixo principal (saída) / Eje principal (salida) / Main shaft (output)				NUP 310 FMN / C3		CRB
Eixo secundário / Eje secundario / Secondary shaft				F 19019	0049815801	CRBS
Eixo secundário (traseiro) / Eje secundario (trasero) / Secondary shaft (rear)			S 6-90	6314		BB
			S 6-90/9.01 + N 70/1B	6314 C3		BB
			G 3/55-6/8,5	F 19046		CRBS
			4S-120 GP	NUP 311 FMNR / C3		CRB
			G 3/50-5/8,5 + NA 3/60-1B * G 3/60-5/7,5 * G 3/50	QJ 309 FM		BB4PAC
			QJ 309 FM	0009813105		BB4PAC
Tampa (traseiro) / Cubierta (trasero) / Cover (rear)			8S-1350	6218 C3		BB
Tomada de força / Toma de fuerza / Power take-off				6208 N	000625506208	BB

Eixo Traseiro / Eje Trasero / Rea r Axle

Diferencial - coroa lateral (dir./esq.) / Diferencial - corona lateral (der./izq.) / Differential - crown gear (right/left)			HL 4/10 D-10/43:7 * HL 4/10 D-10/41:7 * HL 4/10 D-10/47:9 * HL 4/01 D-10/41:7 * HL 4/01 D-10/43:7 * HL 4/01 D	32018 XF		TRB
			HL 5/2 DZ-10/43:7 * HL 5/2 DZ 10/48:7 * HL 5/60 DZ-10/39:8 * HL 5/60 DZ-10 * HL 5/61 DZ-10/39:8	32020 XF		TRB
			HL 7/021 D-10/3,77	33115 F		TRB
			HL 4/27 D-10/40:7 * HL 4/27 D-10/42:8 * HL 4/27 D-10/43:7 * HL 4/27 D-10/39:8	47487 / 47420 A		TRB
Diferencial - coroa lateral (dir.) / Diferencial - corona lateral (der.) / Differential - crown gear (right)			AL 4/6 DS-6/43:7	47487 / 47420 A		TRB
Diferencial - pinhão (dianteiro) / Diferencial - piñón (delantero) / Differential - pinion (front)			HL 7/021 D-10/3,77	31313 F		TRB

Caixa de Mudanças / Caja de Cambios / Gearbox

Diferencial - pinhão (traseiro) / Diferencial - piñón (trasero) / Differential - pinion (rear)			HL 7/021 D-10/3,77	32314 BF		TRB
			HL 5/2 DZ-10/43:7 * HL 5/2 DZ 10/48:7 * HL 5/60 DZ-10/39:8 * HL 5/60 DZ-10 * HL 5/61 DZ-10/39:8	F 15083		STRB

Eixo Dianteiro / Eje Delantero / Front Axle

Roda / Rueda / Wheel	•		AL 4/6 DS-6/43:7	32017 XF		TRB
		•		32310 F	0019817405	TRB
		•	AL 4/6 DS-6/43:7	33019 F		TRB
		•		33208 F	3849817605 / 0089810105	TRB
		•		33210 F	0039818305	TRB
		•	VL 3/7 D-5	33213 F		TRB
		•		33213 F	0089810005	TRB
		•		33214 F	0039815605 / 0039815205	TRB
	•		F 15051 C	0059813105	STRB	

	OUT	IN		Fersa®	Nº OEM	
---	-----	----	---	---------------	--------	---

MERCEDES BENZ (SA)

1714 * 1714 (L*K*LK) * 1715 * 1718 * 1718 (A * AK) * K * 1720 L * 1721 * 1721 S * 1721 (L*LK) * 1722 S * 1723 * 1723 S * 1725 L

Eixo Traseiro / Eje Trasero / Rear Axle

Roda / Rueda / Wheel	•		HL 7/021 D-10/3,77	33019 F		TRB
		•		33019 F	00298190 (77...)05 / 0039818605	TRB
		•		33020 F	0059818505	TRB
		•		33020 F	014 981 3205	TRB
		•	HL 7/021 D-10/3,77	33021 F		TRB
	•			33116 F	012 981 4005	TRB
	•			33117 F	0059818605	TRB
	•			33215 F	0029818905 / 0029818605	TRB

Motor / Motor / Engine

Alternador (dianteiro) / Alternador (delantero) / Alternator (front)				6303 ZZ / C3	000625900182	BB
				6303 ZZ / C3	000625900193	BB
			OM 366 * OM 366 A/LA (Bosch 14V 55 A) * OM 366 LA II/23	6403 2RS / C3		BB
Alternador (traseiro) / Alternador (trasero) / Alternator (rear)				62201 2RS / C3	00298190 (77...)95	BB
Bomba d'água (dianteiro) / Bomba de agua (delantero) / Water pump (front)				6206 C3	000625900209	BB
			OM 366 * OM 366 A/LA	6206 C3		BB
Bomba d'água (traseiro) / Bomba de agua (trasero) / Water pump (rear)			OM 366 * OM 366 A/LA	6203 C3		BB
				6203 C3	000625900208	BB
Bomba hidráulica / Bomba hidráulica / Hydraulic pump				62204 2RS	0049819625	BB
Bomba injetora (dianteiro) / Bomba inyectora (delantero) / Injection pump (front)				30203 F	000720030203	TRB
Bomba injetora (traseiro) / Bomba inyectora (trasero) / Injection pump (rear)				30204 F	000720030204	TRB
Virabrequim / Cigüeñal / Crankshaft				6204 2RS / C3	000625406204	BB
Virabrequim - ponta / Cigüeñal - punta / Crankshaft spindle			OM 366 * OM 366 A/LA * OM 366 LA II/23 * OM 449 LA	6204 2RS		BB

Tomada de Potência / Toma de Potencia / Power Take-off

Eixo de saída (traseiro) / Eje de salida (trasero) / Output shaft (rear)				6007 N	000625506007	BB
--	--	--	--	---------------	--------------	----

1819 (L*LAK*LB*LG*LK*LS) * 1820 LG

Caixa de Mudanças / Caja de Cambios / Gearbox

Eixo de entrada (dianteiro) / Eje de entrada (delantero) / Input shaft (front)			VG 500-3W * 750610	33210 F		TRB
Eixo de entrada (traseiro) / Eje de entrada (trasero) / Input shaft (rear)			VG 500-3W * 750610	33209 F		TRB
Eixo de saída (dianteiro/traseiro) / Eje de salida (delantero/trasero) / Output shaft (front)			VG 500-3W * 750610	33011 F		TRB
			VG 500-3W * 750610	33113 F		TRB
			VG 500-3W * 750610	6211 N / C3		BB
Eixo intermediário (dianteiro) / Eje intermedio (delantero) / Intermediate shaft (front)			VG 500-3W * 750610	33210 F		TRB
				33210 F	0039818305	TRB
				33885 / 33822	0019809602	TRB
Eixo Intermediário (dianteiro/traseiro) / Eje Intermedio (delantero/trasero) / Intermediate shaft (front/rear)				33889 / 33882	0019809502	TRB
Eixo intermediário (traseiro) / Eje intermedio (trasero) / Intermediate shaft (rear)				33212 F	0059812805	TRB



OUT IN



Fersa®

N° OEM



MERCEDES BENZ (SA)

1819 (L*LAK*LB*LG*LK*LS) * 1820 LG

Caixa de Mudanças / Caja de Cambios / Gearbox

Eixo primário / Eje primario / Primary shaft				NUP 314 FM / C3	0019819802	CRB
			719650	NUP 314 FMNR / C3		CRB
Eixo primário inf. (dianteiro/traseiro) / Eje primario inf. (delantero/trasero) / Primary shaft (front/rear)				6211 N / C3	0059819125	BB
				33112 F		TRB
				33011 F	0029819305	TRB
Eixo primário sup. (dianteiro) / Eje primario sup. (delantero) / Upper primary shaft (front)				33210 F	0039818305	TRB
Eixo primário sup. (traseiro) / Eje primario sup. (trasero) / Upper primary shaft (rear)				33209 F	0039815705	TRB
Eixo secundário (traseiro) / Eje secundario (trasero) / Secondary shaft (rear)			719650	6314 C3		BB
				6314 N / C3	00198190 (77...)25	BB

Eixo Traseiro / Eje Trasero / Rear Axle

Diferencial - coroa lateral (dir.) / Diferencial - corona lateral (der.) / Differential - crown gear (right)			AL 4/6 S-6/43:7 * 733099	47487 / 47420 A		TRB
Diferencial - divisor de torque (dianteiro) / Diferencial - divisor de par (delantero) / Differential - torque divisor (front)			HD 4/21 GS-10/43:7	6312 C3		BB
Diferencial - divisor de torque (traseiro) / Diferencial - divisor de par (trasero) / Differential - torque divisor (rear)			HD 4/21 GS-10/43:7	6211 C3		BB
Diferencial - divisor de torque (interm.) / Diferencial - divisor de par (interm.) / Differential - torque divisor (intermediate)			HD 4/21 GS-10/43:7	6014 C3		BB
Diferencial - pinhão - apoio / Diferencial - piñón - apoyo / Differential - pinion support			733099	33111 F		TRB

Eixo Dianteiro / Eje Delantero / Front Axle



Roda / Rueda / Wheel		•		32017 XF		TRB
	•		AL 4/6 S-6/43:7 * 733099	32017 XF		TRB
		•		32017 XF		TRB
		•	AL 4/6 S-6/43:7 * 733099	33019 F		TRB
		•		33019 F	00298190 (77...)05 / 0039818605	TRB
	•			33210 F	003 981 8305	TRB
		•		33214 F	003 981 5205	TRB

Eixo Traseiro / Eje Trasero / Rear Axle

Roda / Rueda / Wheel		•		33019 F	00298190 (77...)05 / 0039818605	TRB
		•		33022 F	009 981 0905	TRB
	•			33215 F	0029818905 / 0029818605	TRB
				497 / 492 A	0009816105	TRB
				498 / 492 A	0039812005	TRB
Suporte da mola (interno) / Resorte de apoyo (interno) / Spring support (inner)			LG-1819/1820	497 / 492 A		TRB

Motor / Motor / Engine

Alternador (traseiro) / Alternador (trasero) / Alternator (rear)			OM 355/5I	6201 2RS / C3		BB
			OM 355/5I	62201 2RS / C3		BB
				62201 2RS / C3	00298190 (77...)25	BB
Bomba d'água (dianteiro) / Bomba de agua (delantero) / Water pump (front)			OM 355/5I	6206 C3		BB
				NU 303 FM	0019819601	CRB

	OUT	IN		Fersa®	Nº OEM	
---	-----	----	---	---------------	--------	---

MERCEDES BENZ (SA)

1819 (L*LAK*LB*LG*LK*LS) * 1820 LG

Motor / Motor / Engine

Bomba d'água (traseiro) / Bomba de agua (trasero) / Water pump (rear)				6206	000625006206	BB
Virabrequim / Cigüeñal / Crankshaft				6205 2RS	000625406205	BB
Compressor de ar / Compresor de aire / Air compressor				NJ 305 FM / C3	005412400004	CRB
Virabrequim - ponta / Cigüeñal - punta / Crankshaft spindle			OM 355/5I	6205 2RS		BB

1924 LS * 1924 A LS * 1929 (L*LK*LS) * 1930 LS * 1932 LS * 1933 LS * 1934 LS * 1935 (L*LS) * 1938 * 1938 S * 1938 (L*LS) * 1941 (L*LS) * 1944 S * 1945 (L*LS)

Caixa de Mudanças / Caja de Cambios / Gearbox

Bomba servo direção / Bomba servo dirección / Steering servopump			G 210-16	6004		BB
Eixo da bomba de óleo / Eje de bomba de aceite / Oil pump shaft			G 210-16	6009 C3		BB
Eixo de acionamento / Eje de accionamiento / Drive shaft				F19008		CRBS
Eixo (dianteiro/traseiro) / Eje (delantero/trasero) / Axle (front/rear)				33889 / 33822	0019809502	TRB
Eixo intermediário (dianteiro) / Eje intermedio (delantero) / Intermediate shaft (front)				33885 / 33822	0019809602	TRB
			16 S-130 * 16 S-130-N70/ 1B 16 S-160/190 (77...) * AK 6-90/ 6,98 ... * 16 S-160 * 16 S-160 + N 70/1B * 16 S-1650	F 15047		STRB
Eixo intermediário (traseiro) / Eje intermedio (trasero) / Intermediate shaft (rear)			AK 6-90/6,98	32309 F	0049811305	TRB
			16 S-130 * 16 S-130-N70/1B * 16 S-160/190 (77...) * 16 S-1650	32310 F	0019800102	TRB
Eixo primário / Eje primario / Primary shaft			718000/001/002/003	6208 N	000625506208	BB
				NUP 314 FM / C3	0019819802	CRB
Eixo secundário / Eje secundario / Secondary shaft			4K 120 GP * 4K 121 GP	NUP 311 FMNR / C3		CRB
Eixo secundário (traseiro) / Eje secundario (trasero) / Secondary shaft (rear)				6204 2RS / C3	0039815125	BB
			AK 6-90/6,98	6314 C3	000625536314	BB
Grupo planetária (traseiro) / Grupo planetario (trasero) / Planetary group (rear)			718000/001/002/003	6213 C3		BB
Tampa (traseiro) / Cubierta (trasero) / Cover (rear)			16 S-130-N70/1B * 16 S-160 * 16 S-160 + N 70/1B * 16 S-1650	6218 C3		BB
Tomada de força / Toma de fuerza / Power take-off				6009 C3		BB

Eixo Traseiro / Eje Trasero / Rear Axle

Diferencial - caixa sat.lat. (dir.) / Diferencial - caja sat.lat. (der.) / Differential - satellit box (right)				32020 XF	001 981 6405	TRB
Diferencial - caixa sat.lat. (esq.) / Diferencial - caja sat.lat. (izq.) / Differential - satellit box (left)				32024 XF	014 981 4405	TRB
Diferencial - coroa lateral (dir./esq.) / Diferencial - corona lateral (der./izq.) / Differential - crown gear (right/left)			HL 7/015 D-13 * HL 7/015 D-13/29:24 * HL 7/015 D-13/26:24 * HL 7/015 D-13/ 28:21 * HL 7/015 D-13/4,2 * HL 7/015 D-13/4,64	33115 F	0039813005	TRB

	OUT	IN		Fersa®	N° OEM	
---	-----	----	---	---------------	--------	---

MERCEDES BENZ (SA)

1924 LS * 1924 A LS * 1929 (L*LK*LS) * 1930 LS * 1932 LS * 1933 LS * 1934 LS * 1935 (L*LS) * 1938 * 1938 S * 1938 (L*LS) * 1941 (L*LS) * 1944 S * 1945 (L*LS)

Eixo Traseiro / Eje Trasero / Rear Axle

Diferencial - pinhão (dianteiro) / Diferencial - piñón (delantero) / Differential - pinion (front)			HL 7/015 D-13 * HL 7/015 D-13/29:24 * HL 7/015 D-13/ 26:24 * HL 7/015 D-13/28:21 * HL 7/015 D-13/4,2 * HL 7/015 D-13/4,64	31313 F	0039810605	TRB
Diferencial - pinhão (traseiro) / Diferencial - piñón (trasero) / Differential - pinion (rear)			HL 7/015 D-13 * HL 7/015 D-13/29:24 * HL 7/015 D-13/ 26:24 * HL 7/015 D-13/28:21 * HL 7/015 D-13/4,2 * HL 7/015 D-13/4,64	32314 BF	0039813105	TRB
Diferencial - pinhão apoio / Diferencial - piñón apoyo / Differential - support pinion				31313 F	0039810605	TRB

Eixo Dianteiro / Eje Delantero / Front Axle

Roda / Rueda / Wheel	•			32310 F	0019817405	TRB
	•			32312 F	011 981 6905	TRB
	•			33210 F	0039818305	TRB
		•		33214 F	003 981 5205	TRB
		•		F 15051 C	0059813105	STRB

Eixo Traseiro / Eje Trasero / Rear Axle

Roda / Rueda / Wheel	•		13/29:24 * HL 7/015 D-13/26:24 *	30220 F	0049814906	TRB
		•	740600/602/633/637	30220 F	0049814906	TRB
		•	NR 4/58 DC-10 504022/23	33019 F		TRB
		•		33022 F	0049810905	TRB
	•			33116 F	004 981 2105 / 012 981 4005	TRB
	•		NR 4/58 DC-10 504304 38/39	33210 F		TRB
		•	NR 4/58 DC-10 504304 38/39	33214 F		TRB
	•		NR 4/58 DC-10 504022/23	33215 F		TRB
		•	HL 7/015 D-13 * HL 7/015 D-13/29:24 * HL 7/015 D-13/26:24 * HL 7/015 D-13/28:21 * HL 7/015 D-13/4,2 * HL 7/015 D-13/4,64 * HL 7/015 D-13/5,22 * HL 7/015 D-13/3,77 * HL 7/025DC-1	33022 F		TRB

Embreagem / Embrague / Clutch

Apoio / Apoyo / Support			345910/912/913	6205 2RS		BB
				6205 2RS	000625406205	BB

Motor / Motor / Engine

Alternador (dianteiro) / Alternador (delantero) / Alternator (front)				6203 2RS / C3	0089810605	BB
Alternador (traseiro) / Alternador (trasero) / Alternator (rear)				6201 2RS / C3	0089810705	BB
				62201 2RS / C3	00298190 (77...)95	BB
Bomba d'água (dianteiro) / Bomba de agua (delantero) / Water pump (front)			OM 355 A	6206 C3		BB
				NU 303 FM	0019819601	CRB

	OUT	IN		Fersa®	N° OEM	
---	-----	----	---	---------------	--------	---

MERCEDES BENZ (SA)

1924 LS * 1924 A LS * 1929 (L*LK*LS) * 1930 LS * 1932 LS * 1933 LS * 1934 LS * 1935 (L*LS) * 1938 * 1938 S * 1938 (L*LS) * 1941 (L*LS) * 1944 S * 1945 (L*LS)

Motor / Motor / Engine

Bomba d'água (traseiro) / Bomba de agua (traseiro) / Water pump (rear)				6206 C3	000625006206	BB
Bomba injetora (dianteiro/traseiro) / Bomba inyectora (delantero/traseiro) / Injection pump (front/rear)				30205 F	000720030205	TRB
Virabrequim / Cigüeñal / Crankshaft				6205 2RS	000625406205	BB
Compressor de ar / Compresor de aire / Air compressor				NJ 305 FM / C3	005412400004	CRB
Virabrequim - ponta / Cigüeñal - punta / Crankshaft spindle			OM 355 A	6205 2RS		BB
			OM 457 LA	6206 2RS		BB

Tomada de Força / Toma de Fuerza / Power Take-off

Eixo de saída (traseiro) / Eje de salida (traseiro) / Output shaft (rear)			16 S-130-N70/ 1B * 16 S-160 * 16 S-160 + N 70/1B	6208 N		BB
Eixo intermediário (traseiro) / Eje intermedio (traseiro) / Intermediate shaft (rear)			16 S-130-N70/ 1B * 16 S-160 * 16 S-160 + N 70/1B	6009 C3		BB

Tomada de Potência / Toma de Potencia / Power Take-off

Eixo de saída (traseiro) / Eje de salida (traseiro) / Output shaft (rear)				6208 N	000625506208	BB
Eixo intermediário (traseiro) / Eje intermedio (traseiro) / Intermediate shaft (rear)				6009 C3	000625036009	BB

2013 (L*LA*LAK*LB*LG*LK*LS) * 2013 6X2 (L) * 2014 (L*LB*LK) * 2016 (LB*LK) * 2017 (L*LB*LK)

Caixa de Mudanças / Caja de Cambios / Gearbox

Eixo Intermediário (dianteiro/traseiro) / Eje Intermedio (delantero/traseiro) / Intermediate shaft (front/rear)				30308 F	0019813105 / 0019815005	TRB
			G 3/36-5/8,98 * G 3/50-5/8,5 * G 3/60-5/7,5	30308 F		TRB
Eixo primário (dianteiro) / Eje primario (delantero) / Primary shaft (front)				QJ 209 FM	3459817027	BB4PAC
				QJ 212 FM	3459817627	BB4PAC
Eixo primário (traseiro) / Eje primario (traseiro) / Primary shaft (rear)			G 3/50-5/8,5 * G 3/60-5/7,5	F 19011		CRBS
				NU 209 FMN	3449817101	CRB
Eixo secundário (traseiro) / Eje secundario (traseiro) / Secondary shaft (rear)			G 3/36-5/8,98 * G 3/50-5/8,5 * G 3/60-5/7,5	QJ 309 FM		BB4PAC
				QJ 309 FM	3459817127 / 3459817727	BB4PAC

Eixo Traseiro / Eje Trasero / Rear Axle

Diferencial - caixa sat.lat. (dir.) / Diferencial - caja sat.lat. (der.) / Differential - satellit box (right)				32012 XF	007 981 2105	TRB
				32022 XF	002 981 5005	TRB
Diferencial - caixa sat.lat. (esq.) / Diferencial - caja sat.lat. (izq.) / Differential - satellit box (left)				32017 XF	005 981 1405	TRB
				32018 XF	004 981 4305	TRB
Diferencial - coroa lateral (dir./esq.) / Diferencial - corona lateral (der./izq.) / Differential - crown gear (right/left)			HD 4/22-10/43:7	33114 F		TRB
			L-2013 6x2	47487 / 47420 A		TRB
Diferencial - pinhão (traseiro) / Diferencial - piñón (traseiro) / Differential - pinion (rear)				F 15159	006 981 3505	STRB

Eixo Dianteiro / Eje Delantero / Front Axle

Roda / Rueda / Wheel	•			32307 F	0039816405	TRB
	•			32310 F	001 981 7405	TRB
	•			33207 F	5810705	TRB

	OUT	IN		Fersa®	N° OEM	
---	-----	----	---	---------------	--------	---

MERCEDES BENZ (SA)

2013 (L*LA*LAK*LB*LG*LK*LS) * 2013 6X2 (L) * 2014 (L*LB*LK) * 2016 (LB*LK) * 2017 (L*LB*LK)

Eixo Dianteiro / Eje Delantero / Front Axle

Roda / Rueda / Wheel	•			33208 F	3849817605 / 0089810105	TRB
		•		33213 F	0089810005	TRB
		•		559 / 552 A	3449817005	TRB
		•		F 15051 C	005 981 3105	STRB

Eixo Traseiro / Eje Trasero / Rear Axle

Roda / Rueda / Wheel		•		32011 XF	002 981 6605	TRB
	•			32014 XF	005 981 6605	TRB
				32022 XF	0029815005	TRB
		•		33019 F	00298190 (77...)05 / 0039818605	TRB
		•		33020 F	014 981 3205	TRB
	•			33116 F	012 981 4005	TRB
	•		HD 4/22 D-10/43:7 * NR 4/22 D-10 (6x2)	33215 F		TRB
				497 / 492 A	0009816105	TRB
				498 / 492 A	0039812005	TRB
		•		598 A / 593 X	0039811405	TRB
Suporte da mola (interno) / Resorte de apoyo (interno) / Spring support (inner)			L-2013/2014/2017	497 / 492 A		TRB

Embreagem / Embrague / Clutch

Apoio / Apoyo / Support			344963	6204 2RS		BB
				6204 2RS / C3	000625406204	BB

Motor / Motor / Engine

Alternador (dianteiro) / Alternador (delantero) / Alternator (front)				6303 2RS / C3	000625406303	BB
				6303 ZZ / C3	000625900182	BB
				6303 ZZ / C3	000625900193	BB
Alternador (traseiro) / Alternador (trasero) / Alternator (rear)				6201 ZZ / C3	0049812425	BB
			OM 352 A/I	62201 2RS / C3		BB
Bomba d'água (dianteiro) / Bomba de agua (delantero) / Water pump (front)				6203 C3	000625900208	BB
Bomba d'água (traseiro) / Bomba de agua (trasero) / Water pump (rear)				6206 C3	000625006206	BB
Bomba hidráulica / Bomba hidráulica / Hydraulic pump				62204 2RS	0049819625	BB
Bomba injetora (dianteiro) / Bomba inyectora (delantero) / Injection pump (front)				30203 F	000720030203	TRB
Bomba injetora (traseiro) / Bomba inyectora (trasero) / Injection pump (rear)				30203 F	000720030203	TRB
				30204 F	000720030204	TRB
Virabrequim / Cigüeñal / Crankshaft				6204 2RS / C3	000625406204	BB

2213 (L*LB*LK*LS) * 2213 6X6 (LA) * 2214 * 2215 (L*LB*LK*LS) * 2216 (L*LA*LAK*LB*LG*LK*LS) * 2217 (L*LB*LK*LS) * 2219 (L*LA*LAK*LB*LG*LK*LS) * 2220 * 2222 * 2225 (L*LB*LK*LS)

Caixa de Mudanças / Caja de Cambios / Gearbox

Eixo de entrada (dianteiro) / Eje de entrada (delantero) / Input shaft (front)			ZG 500-3W/1,64 * ZG 500-3W/1,85	33210 F		TRB
Eixo de entrada (traseiro) / Eje de entrada (trasero) / Input shaft (rear)			ZG 500-3W/1,64 * ZG 500-3W/1,85	33209 F		TRB
Eixo de saída (dianteiro/traseiro) / Eje de salida (delantero/trasero) / Output shaft (front)			ZG 500-3W/1,64 * ZG 500-3W/1,85	33011 F		TRB



MERCEDES BENZ (SA)

2213 (L*LB*LK*LS) * 2213 6X6 (LA) * 2214 * 2215 (L*LB*LK*LS) * 2216 (L*LA*LAK*LB*LG*LK*LS) * 2217 (L*LB*LK*LS) *
 2219 (L*LA*LAK*LB*LG*LK*LS) * 2220 * 2222 * 2225 (L*LB*LK*LS)

Caixa de Mudanças / Caja de Cambios / Gearbox

Eixo de saída (dianteiro/traseiro) / Eje de salida (delantero/trasero) / Output shaft (front)		ZG 500-3W/1,64 * ZG 500-3W/1,85	33113 F		TRB
		ZG 500-3W/1,64 * ZG 500-3W/1,85	6211 N / C3		BB
Eixo intermediário / Eje intermedio / Intermediate shaft		G 3/36-5/8,98 * G 3/50-5/8,5 * G 3/60-5/7,5 * G 3/50-5/8,5 + NA 3/60-1B	30309 F		TRB
Eixo intermediário (dianteiro) / Eje intermedio (delantero) / Intermediate shaft (front)		ZG 500-3W/1,64 * ZG 500-3W/1,85	33210 F		TRB
			33210 F	0039818305	TRB
			32309 F	0049811305	TRB
			33885 / 33822	0019809602	TRB
		G 3/50-5/8,5 + NA 3/60-1B	F 15047		STRB
			30309 F	00198113705	TRB
Eixo Intermediário (dianteiro/traseiro) / Eje Intermedio (delantero/trasero) / Intermediate shaft (front/rear)			30308 F	0019813105 / 0019815005	TRB
			33889 / 33822	0019809502	TRB
		G 3/36-5/8,98 * G 3/40-5/7,5 * G 3/50-5/8,5 * G 3/60-5/7,5 * AK 6-80/9,0 * AK 6-80/9,0 GV80 * G 3/60-5/7,5 + NA 3/60-1B	30308 F		TRB
Eixo intermediário (traseiro) / Eje intermedio (trasero) / Intermediate shaft (rear)			33212 F	0059812805	TRB
		ZG 500-3W/1,64 * ZG 500-3W/1,85	33212 F		TRB
		G 3/60-5/7,5 + NA 3/60-1B	32309 F		TRB
Eixo primário / Eje primario / Primary shaft			NUP 314 FM / C3	0019819802	CRB
			QJ 209 FM	3459817027	BB4PAC
Eixo primário (dianteiro) / Eje primario (delantero) / Primary shaft (front)			QJ 212 FM	3459817627	BB4PAC
Eixo primário (dianteiro/traseiro) / Eje primario (delantero/trasero) / Primary shaft (front/rear)			NU 209 FMN	3449817101	CRB
Eixo primário (traseiro) / Eje primario (trasero) / Primary shaft (rear)		G 3/50-5/8,5 * G 3/6-5/7,5 * AK 6-80/9,0 * AK 6-80/9,0 GV80 * G 3/60-5/7,5 + NA 3/60-1B	F 19011		CRBS
Eixo primário inf. dianteiro / Eje primario inf. (delantero) / Primary shaft (front)			6308 ZNR / C3	3129811325	BB
Eixo primário inf. (dianteiro/traseiro) / Eje primario inf. (delantero/trasero) / Primary shaft (front/rear)			33112 F		TRB
			6211 N / C3	0019819125	BB
Eixo primário inf. (traseiro) / Eje primario inf. (trasero) / Primary shaft (rear)			33011 F	0029819305	TRB
			NJ 2211 FM	000628000339	CRB
Eixo primário sup. (dianteiro) / Eje primario sup. (delantero) / Upper primary shaft (front)			30309 F	00198113705	TRB
			33210 F	0039818305	TRB
Eixo primário sup. (traseiro) / Eje primario sup. (trasero) / Upper primary shaft (rear)			30308 F	0019813105 / 0019815005	TRB
			33209 F	0039815705	TRB
			NUP 311 FM / C3	0059815201	CRB

	OUT	IN		Fersa®	N° OEM	
---	-----	----	---	---------------	--------	---

MERCEDES BENZ (SA)

2213 (L*LB*LK*LS) * 2213 6X6 (LA) * 2214 * 2215 (L*LB*LK*LS) * 2216 (L*LA*LAK*LB*LG*LK*LS) * 2217 (L*LB*LK*LS) * 2219 (L*LA*LAK*LB*LG*LK*LS) * 2220 * 2222 * 2225 (L*LB*LK*LS)

Caixa de Mudanças / Caja de Cambios / Gearbox

Eixo secundário (interm.) / Eje secundario (interm.) / Secondary shaft (interm.)			G 3/36-5/8,98 * G 3/40-5/7,5 * AK 6-80/9,0 * AK 6-80/9,0 GV80 * G 3/50-5/8,5 * G 3/6-5/7,5 * G 3/60-5/7,5 + NA 3/60-1B	QJ 309 FM		BB4PAC
Eixo secundário (traseiro) / Eje secundario (traseiro) / Secondary shaft (rear)				6314 N / C3	00198190 (77...)25	BB
				QJ 309 FM	3459817127 / 3459817727	BB4PAC

Eixo Traseiro / Eje Trasero / Rear Axle

Diferencial - coroa lateral (dir./esq.) / Diferencial - corona lateral (der./izq.) / Differential - crown gear (right/left)			HD 4/02 DG-10/43:10 * HD 4/03 DG-10/43:10 * HD 4/03 D-10/41:7 * HD 4/02 DG-10 * HD 4/03 D-10	32018 XF		TRB
			HD 4/21G-10/40:7 * HD 4/22-10/40:7 * HD 4/21 G-10/43:7 * HD 4/22-10/43:7 * HD 4/21 DG-10/43:7 * HD 4/22 D	33114 F		TRB
			HD 4/22 D-10/48:7 * HD 4/21 DG-10/43:7 * D-10/48:7	47487 / 47420 A		TRB
Diferencial - pinhão (traseiro) / Diferencial - piñón (traseiro) / Differential - pinion (rear)				F 15159	0069813505	STRB

Eixo Dianteiro / Eje Delantero / Front Axle

Roda / Rueda / Wheel	•			32307 F	0039816405	TRB
	•			33208 F	3849817605 / 0089810105	TRB
		•		33213 F	0089810005	TRB
		•		497 / 492 A	0009816105	TRB
		•		559 / 552 A	3449817005	TRB

Eixo Traseiro / Eje Trasero / Rear Axle

Roda / Rueda / Wheel		•		33019 F	00298190 (77...)05 / 0039818605	TRB
		•		33020 F	0059818505	TRB
		•		33117 F	0059818605	TRB
		•		33215 F	0029818905 / 0029818605	TRB
				497 / 492 A	0009816105	TRB
				498 / 492 A	0039812005	TRB
		•		598 A / 593 X	0039811405	TRB
		•		598 A / 593 X	0039811405	TRB

Eixo Motriz / Eje Motriz / Trailing Axle

				6014 C3	000625036014	BB
				6211 C3	000625036211	BB
				6312 C3	000625036312	BB
				NU 209 FMN	3449817101	CRB
				QJ 309 FM	3459817127 / 3459817727	BB4PAC

	OUT	IN		Fersa®	Nº OEM	
---	-----	----	---	---------------	--------	---

MERCEDES BENZ (SA)

2213 (L*LB*LK*LS) * 2213 6X6 (LA) * 2214 * 2215 (L*LB*LK*LS) * 2216 (L*LA*LAK*LB*LG*LK*LS) * 2217 (L*LB*LK*LS) *
 2219 (L*LA*LAK*LB*LG*LK*LS) * 2220 * 2222 * 2225 (L*LB*LK*LS)

Divisor de torque (dianteiro) / Divisor de par (delantero) / Torque divisor (front)			HD 4/21 G-10/40:7 * HD 4/21 G-10/43:7 * HD 4/21 DG-10/48:7 * HD 4/21 DG-10/43:7 HD 4/02 DG-10/ 43:10 * HD 4/02 DG-10/41:7	6312 C3		BB
Divisor de torque (traseiro) / Divisor de par (trasero) / Torque divisor (rear)			HD 4/21 G-10/40:7 * HD 4/21 G-10/43:7 * HD 4/21 DG-10/ 48:7 * HD 4/21 DG-10/43:7 * HD 4/02 DG-10/43:10 * HD 4/02 DG-10/41:7	6211 C3		BB
Divisor de torque (interm.) / Divisor de par (interm.) / Torque divisor (intermediate)			HD 4/21 G-10/40:7 * HD 4/21 G-10/43:7	6014 C3		BB
Suporte da mola (interno) / Resorte de apoio (interno) / Spring support (inner)				497 / 492 A		TRB
Embreagem / Embrague / Clutch						
Apoio / Apoyo / Support			L/LB/LK/LA (6x6)-2213	6204		BB
			345973	6205 2RS		BB
				6204 2RS	000625006204	BB
				6205 2RS	000625406205	BB
Motor / Motor / Engine						
Alternador (dianteiro) / Alternador (delantero) / Alternator (front)				6201 2RS / C3	0089810705	BB
				6303 2RS / C3	000625406303	BB
				6303 ZZ / C3	000625900182	BB
				6303 ZZ / C3	000625900193	BB
			OM 449 A	6403 2RS / C3		BB
Alternador (traseiro) / Alternador (trasero) / Alternator (rear)			OM 352 * OM 352 O	6201 2RS / C3		BB
			OM 355/5A * OM 449 A * OM 352 O	62201 2RS / C3		BB
				62201 2RS / C3	00298190 (77...)25	BB
Bomba d'água (dianteiro) / Bomba de agua (delantero) / Water pump (front)				6203 C3	000625900208	BB
				6206 2RS	000625900209	BB
Bomba d'água (traseiro) / Bomba de agua (trasero) / Water pump (rear)				6203	000625006203	BB
Bomba d'água (traseiro) / Bomba de agua (trasero) / Water pump (rear)				6206 C3	000625006206	BB
				NU 303 FM	0019819601	CRB
Bomba injetora (dianteiro/traseiro) / Bomba inyectora (delantero/trasero) / Injection pump (front/rear)				30203 F	000720030203	TRB
				30204 F	000720030204	TRB
				30205 F	000720030205	TRB
			OM 355/5A	32205 BF		TRB
Virabrequim / Cigüeñal / Crankshaft				6204 2RS / C3	000625406204	BB
				6205 2RS	000625406205	BB
Compressor (dianteiro) / Compresor (delantero) / Compressor (front)			OM 355/5A	NJ 305 C3		CRB
Compressor de ar / Compresor de aire / Air compressor				NJ 305 FM / C3	005412400004	CRB
Virabrequim - ponta / Cigüeñal - punta / Crankshaft spindle			OM 352 A/I	6204 2RS		BB
			OM 352 O * OM 352 A/AI	6204 2RS		BB
			OM 355/5A * OM 355/5I	6205 2RS		BB

	OUT	IN		Fersa®	N° OEM	
---	-----	----	---	---------------	--------	---

MERCEDES BENZ (SA)

2213 (L*LB*LK*LS) * 2213 6X6 (LA) * 2214 * 2215 (L*LB*LK*LS) * 2216 (L*LA*LAK*LB*LG*LK*LS) * 2217 (L*LB*LK*LS) * 2219 (L*LA*LAK*LB*LG*LK*LS) * 2220 * 2222 * 2225 (L*LB*LK*LS)

Tomada de Força / Toma de Fuerza / Power Take-off

Eixo de entrada / Eje de entrada / Input shaft			4 S-120 GP	6209 C3		BB
Eixo de saída (traseiro) / Eje de salida (trasero) / Output shaft (rear)			G 3/60-5/7,5 + NA 3/60-1B	6007 N		BB
Eixo intermediário / Eje intermedio / Intermediate shaft			4 S-120 GP	6208 N		BB



Tomada de Potência / Toma de Potencia / Power Take-off

Eixo de entrada / Eje de entrada / Input shaft				6209 C3	000625506208	BB
Eixo primário (dianteiro) / Eje primario (delantero) / Primary shaft (front)				6208 N	000625506208	BB
Eixo primário (traseiro) / Eje primario (trasero) / Primary shaft (rear)				6007 N	000625506007	BB

2314 (L*LB*LK*LS) * 2318 (L*LB*LK*LS) * 2325 (L*LB*LK*LS)

Caixa de Mudanças / Caja de Cambios / Gearbox

Eixo de entrada (dianteiro) / Eje de entrada (delantero) / Input shaft (front)			ZG 500-3W / 1,85	33210 F		TRB
Eixo de entrada (traseiro) / Eje de entrada (trasero) / Input shaft (rear)			ZG 500-3W / 1,85	33209 F		TRB
Eixo de saída (dianteiro/traseiro) / Eje de salida (delantero/trasero) / Output shaft (front)			ZG 500-3W / 1,85	33011 F		TRB
			ZG 500-3W / 1,85	33113 F		TRB
			ZG 500-3W / 1,85	6211 N / C3		BB
Eixo intermediário (dianteiro) / Eje intermedio (delantero) / Intermediate shaft (front)				33210 F	0039818305	TRB
				33885 / 33822	0019809602	TRB
Eixo Intermediário (dianteiro/traseiro) / Eje Intermedio (delantero/trasero) / Intermediate shaft (front/rear)				30308 F	0019813105 / 0019815005	TRB
				33889 / 33822	0019809502	TRB
			G 3/60-5/7,5 * G 3/50-5/8,5 * G 3/60-5/7,5 + NA 3/60-1B * G 3/55-6/8,5	30308 F		TRB
Eixo intermediário (traseiro) / Eje intermedio (trasero) / Intermediate shaft (rear)				33212 F	0059812805	TRB
Eixo primário / Eje primario / Primary shaft			G 3/55-6/8,5	F 19047		CRBS
Eixo primário (dianteiro) / Eje primario (delantero) / Primary shaft (front)				QJ 212 FM	3459817627	BB4PAC
Eixo primário (traseiro) / Eje primario (trasero) / Primary shaft (rear)			G 3/50-5/8,5 * G 3/60-5/7,5 (LB-2318) * G 3/60-5/7,5 + NA 3/60-1B	F 19011		CRBS
				33112 F		TRB
Eixo primário inf. (dianteiro/traseiro) / Eje primario inf. (delantero/trasero) / Primary shaft (front/rear)				6211 N / C3	0019819125	BB
				33011 F	0029819305	TRB
Eixo primário inf. (traseiro) / Eje primario inf. (trasero) / Primary shaft (rear)				33210 F	0039818305	TRB
Eixo primário sup. (dianteiro) / Eje primario sup. (delantero) / Upper primary shaft (front)				33209 F	0039815705	TRB
Eixo secundário / Eje secundario / Secondary shaft			4 S-120 GP * 4 S-120 GP + N70/18	NUP 311 FMNR / C3		CRB
Eixo secundário (traseiro) / Eje secundario (trasero) / Secondary shaft (rear)			G 3/55-6/8,5	F 19046		CRBS
			G 3/50-5/8,5 * G 3/60-5/7,5 (LB-2318) * G 3/60-5/7,5 + NA 3/60-1B	QJ 309 FM		BB4PAC
				QJ 309 FM	0009813105	BB4PAC

	OUT	IN		Fersa®	Nº OEM	
---	-----	----	---	---------------	--------	---

MERCEDES BENZ (SA)

2314 (L*LB*LK*LS) * 2318 (L*LB*LK*LS) * 2325 (L*LB*LK*LS)

Eixo Traseiro / Eje Trasero / Rear Axle

Diferencial - coroa lateral (dir./esq.) / Diferencial - corona lateral (der./izq.) / Differential - crown gear (right/left)			HD 4/02 DG-10/43:10 * HD 4/03 D-10/43:10 * HD 4/03 D-10/47:12	32018 XF		TRB
			HD 4/21 DG-10/40:7 * HD 4/22 D-10/40:7 * HD 4/21 DG-10/48:7 * HD 4/22 D-10/48:7 * HD 4/21 DG-10/43:7 * HD 4/22 D-10/43	33114 F		TRB

Eixo Dianteiro / Eje Delantero / Front Axle

Roda / Rueda / Wheel	•			33208 F	3849817605 / 0089810105	TRB
		•		33213 F	0089810005	TRB

Eixo Traseiro / Eje Trasero / Rear Axle

Roda / Rueda / Wheel				32018 XF	0049814305	TRB
		•		33019 F	00298190 (77...)05 / 0039818605	TRB
		•		33020 F	0059818505	TRB
	•			33117 F	0059818605	TRB
	•			33215 F	0029818905 / 0029818605	TRB
Divisor de torque (dianteiro) / Divisor de par (delantero) / Torque divisor (front)			HD 4/21 DG-10/40:7 * HD 4/21 DG-10/48:7	6312 C3		BB
Divisor de torque (traseiro) / Divisor de par (traseiro) / Torque divisor (rear)			HD 4/21 DG-10/40:7 * HD 4/21 DG-10/48:7	6211 C3		BB

Eixo Dianteiro / Eje Delantero / Front Axle

Eixo auxiliar - roda (externo) / Eje auxiliar - rueda (externo) / Auxiliar shaft - wheel (outner)			NR 4/22 D-10	33215 F		TRB
Eixo auxiliar - roda (interno) / Eje auxiliar - rueda (interno) / Auxiliar shaft - wheel (inner)			NR 4/22 D-10	33019 F		TRB
Suporte da mola / Resorte de apoyo / Spring support			ZG 500-3W/1,85	32018 XF		TRB

Motor / Motor / Engine

Alternador (dianteiro) / Alternador (delantero) / Alternator (front)				6303 ZZ / C3	000625900182	BB
				6303 ZZ / C3	000625900193	BB
			OM 366 A	6403 2RS / C3		BB
Alternador (traseiro) / Alternador (traseiro) / Alternator (rear)			OM 366 A	62201 2RS / C3		BB
				62201 2RS / C3	00298190 (77...)95	BB
Bomba d'água (dianteiro) / Bomba de agua (delantero) / Water pump (front)				6206 C3	000625900209	BB
Bomba d'água (traseiro) / Bomba de agua (traseiro) / Water pump (rear)			OM 366 A	6203 C3		BB
				6203 C3	000625900208	BB
Bomba hidráulica / Bomba hidráulica / Hydraulic pump				62204 2RS	0049819625	BB
Bomba injetora (dianteiro) / Bomba inyectora (delantero) / Injection pump (front)				30203 F	000720030203	TRB
Bomba injetora (traseiro) / Bomba inyectora (traseiro) / Injection pump (rear)				30204 F	000720030204	TRB
Virabrequim / Cigüeñal / Crankshaft				6204 2RS / C3	000625406204	BB
Virabrequim - ponta / Cigüeñal - punta / Crankshaft spindle			OM 366 A	6204 2RS		BB

Tomada de Força / Toma de Fuerza / Power Take-off

Eixo de entrada / Eje de entrada / Input shaft			4 S-120 GP + N70/18	6209 C3		BB
Eixo de saída (traseiro) / Eje de salida (traseiro) / Output shaft (rear)			G 3/60-5/7,5 + NA 3/60-1B	6007 N		BB



OUT IN



Fersa®

N° OEM



MERCEDES BENZ (SA)

2314 (L*LB*LK*LS) * 2318 (L*LB*LK*LS) * 2325 (L*LB*LK*LS)

Tomada de Potência / Toma de Potencia / Power Take-off

Eixo de entrada / Eje de entrada / Input shaft				6209 C3	000625506208	BB
Eixo primário (traseiro) / Eje primario (trasero) / Primary shaft (rear)				6007 N	000625506007	BB

2414 (6X4) * 2414 (L) * 2418 (L*LB*LK) * 2420 (L*LB*LK) * 2423 B 6X4 * 2423 K 6X4 * 2425 6X6 (LA) * 2425 (L*LB*LK) * 2428 6X4

Caixa de Mudanças / Caja de Cambios / Gearbox



Eixo primário (dianteiro) / Eje primario (delantero) / Primary shaft (front)			VG 1400-3 W/1,69	6211 N / C3		BB
Coroa dentada inf. (dianteiro) / Corona dentada inf. (delantero) / Lower crown (front)			VG 1400-3 W/1,69	32015 XF		TRB
Coroa dentada interior (traseiro) / Corona dentada interior (trasero) / Inner crown gear (rear)			VG 1400-3 W/1,69	33109 F		TRB
Eixo intermediário (dianteiro) / Eje intermedio (delantero) / Intermediate shaft (front)			ZG 500-3W/1,64 * ZG 500-3W/1,85	33210 F		TRB
Eixo intermediário (traseiro) / Eje intermedio (trasero) / Intermediate shaft (rear)			ZG 500-3W/1,64 * ZG 500-3W/1,85	33212 F		TRB
Eixo primário (dianteiro) / Eje primario (delantero) / Primary shaft (front)			ZG 500-3W/1,64 * ZG 500-3W/1,85	33210 F		TRB
Eixo primário (traseiro) / Eje primario (trasero) / Primary shaft (rear)			VG 1400-3 W/1,69	30312 F		TRB
			ZG 500-3W/1,64 * ZG 500-3W/1,85	33209 F		TRB
Eixo transm.do eixo dianteiro / Eje transm.de eje delantero / Transmission shaft - front axle			ZG 500-3W/1,64 * ZG 500-3W/1,85	6211 N / C3		BB
Eixo transm.do eixo traseiro (dir.) / Eje transm.de trasero (der.) / Transmission shaft - rear axle (right)			ZG 500-3W/1,64 * ZG 500-3W/1,85	33011 F		TRB
Eixo transm.do eixo traseiro (esq.) / Eje transm.de trasero (izq.) / Transmission shaft - rear axle (left)			ZG 500-3W/1,64 * ZG 500-3W/1,85	33113 F		TRB
Porta planetários (dianteiro) / Porta planerativos (delantero) / Planetary support (front)			VG 1400-3 W/1,69	32019 XF		TRB

Eixo Traseiro / Eje Trasero / Rear Axle

Diferencial - bloqueio / Diferencial - bloqueio / Differential - block			HD 4/21 DG-10 * H 4/22 D-10 * HD 4/22 D-10/48:7	6014 C3		BB
Diferencial - coroa lateral (dir./esq.) / Diferencial - corona lateral (der./izq.) / Differential - crown gear (right/left)			HD 4/02 DG-10/43:10 * HD 4/02 DG-10/47:12 * HD 4/03 D-10/43:10 * HD 4/03 D-10/47:12 * HD 4/02 D-10/43:10	32018 XF		TRB
			HL 5/2 DZ-10/40:7	32020 XF		TRB
			HD 4/21 DG-10/40:7 * HD 4/22 D-10/40:7 * HD 4/22 D-10/43:7 * HD 4/21 DG-10/48:7 * HD 4/22 D-10/48:7 * HD 4/21 D	33114 F		TRB
Diferencial - pinhão (traseiro) / Diferencial - piñón (trasero) / Differential - pinion (rear)			HL 5/2 DZ-10/40:7	F 15083		STRB
				F 15083	0069811705	STRB
				F 15159	0069813505	STRB
Diferencial - pinhão (dianteiro) / Diferencial - piñón (delantero) / Differential - pinion (front)				F 15183	0069811705	TRBS

Eixo Dianteiro / Eje Delantero / Front Axle

Roda / Rueda / Wheel	•		VL 3/8 D-6,5	33109 F		TRB
	•		VL 3/7 D-5	33208 F		TRB
	•			33210 F	0039818305	TRB
		•	VL 3/7 D-5	33213 F		TRB

	OUT	IN		Fersa®	Nº OEM	
---	-----	----	---	---------------	--------	---

MERCEDES BENZ (SA)

2414 (6X4) * 2414 (L) * 2418 (L*LB*LK) * 2420 (L*LB*LK) * 2423 B 6X4 * 2423 K 6X4 * 2425 6X6 (LA) * 2425 (L*LB*LK) * 2428 6X4

Eixo Dianteiro / Eje Delantero / Front Axle

Roda / Rueda / Wheel		•	VL 3/8 D-6,5	33214 F		TRB
		•		33214 F	0039815605 / 0039815205	TRB

Eixo Traseiro / Eje Trasero / Rear Axle

Roda / Rueda / Wheel		•		33019 F	00298190 (77...)05 / 0039818605	TRB
		•		33020 F	0059818505	TRB
	•			33116 F	012 981 4005	TRB
	•			33117 F	0059818605	TRB
	•			33215 F	0029818905 / 0029818605	TRB
				6211 C3	000625036211	BB
				6312 C3	000625036312	BB
Divisor de torque (dianteiro) / Divisor de par (delantero) / Torque divisor (front)			HD 4/21 DG-10/40:7 * HD 4/21 DG-10/48:7 * HD 4/21 DG-10/43:7 * HD 4/02 DG-10/43:10 * HD 4/02 DG-10/47:12 * HD 4/03 D	6312 C3		BB
Divisor de torque (traseiro) / Divisor de par (traseiro) / Torque divisor (rear)			HD 4/21 DG-10/40:7 * HD 4/21 DG-10/48:7 * HD 4/21 DG-10/43:7 * HD 4/21 DG-10 * H 4/22 D-10	6211 C3		BB
Eixo da bomba de óleo / Eje de bomba de aceite / Oil pump shaft			G 221-9	6009 C3		BB
Eixo intermediário (dianteiro) / Eje intermedio (delantero) / Intermediate shaft (front)			8 S-1350 * 8 S-1350 + N 70/1B	F 15047		STRB
Eixo Intermediário (dianteiro/traseiro) / Eje Intermedio (delantero/traseiro) / Intermediate shaft (front/rear)			G 3/50-5/8.5 * G 3/50-5/8.5 + NA 3/60-1B * G 3/60-5/7.5 * G 3/60-5/7.5 + NA 3/60-1B	30308 F		TRB
Eixo intermediário (traseiro) / Eje intermedio (traseiro) / Intermediate shaft (rear)			8 S-1350 * 8 S-1350 + N 70/1B	32310 F		TRB
Eixo primário (delantero) / Eje primario (delantero) / Primary shaft (front)			G 3/50-5/8.5 * G 3/50-5/8.5 + NA 3/60-1B	QJ 212 FM		BB4PAC
Eixo primário (traseiro) / Eje primario (traseiro) / Primary shaft (rear)			G 3/50-5/8.5 * G 3/50-5/8.5 + NA 3/60-1B	F 19011		CRBS
Eixo secundário (traseiro) / Eje secundario (traseiro) / Secondary shaft (rear)			4 S-120 GP * 4 S-120 GP + N 70/1B	NUP 311 FMNR / C3		CRB
			G 3/50-5/8.5 * G 3/50-5/8.5 + NA 3/60-1B * G 3/60-5/7.5 * G 3/60-5/7.5 + NA 3/60-1B	QJ 309 FM		BB4PAC
Eixo auxiliar - roda (externo) / Eje auxiliar - rueda (externo) / Auxiliar shaft - wheel (outner)			NR 4/22 D-10	33215 F		TRB
Eixo auxiliar - roda (interno) / Eje auxiliar - rueda (interno) / Auxiliar shaft - wheel (inner)			NR 4/22 D-10	33019 F		TRB
Tampa (traseiro) / Cubierta (traseiro) / Cover (rear)			8 S-1350 * 8 S-1350 + N 70/1B	6218 C3		BB

Motor / Motor / Engine

Alternador (dianteiro) / Alternador (delantero) / Alternator (front)				6303 ZZ / C3	000625900182	BB
				6303 ZZ / C3	000625900193	BB
				6403 2RS / C3	0049812425	BB

	OUT	IN		Fersa®	N° OEM	
---	-----	----	---	---------------	--------	---

MERCEDES BENZ (SA)

2414 (6X4) * 2414 (L) * 2418 (L*LB*LK) * 2420 (L*LB*LK) * 2423 B 6X4 * 2423 K 6X4 * 2425 6X6 (LA) * 2425 (L*LB*LK) * 2428 6X4

Motor / Motor / Engine

Alternador (traseiro) / Alternador (trasero) / Alternator (rear)				62201 2RS / C3	00298190 (77...)95	BB
Bomba d'água (dianteiro) / Bomba de agua (delantero) / Water pump (front)				6206 C3	000625900209	BB
			OM 366 * OM 366 A	6206 2RS		BB
Bomba d'água (traseiro) / Bomba de agua (trasero) / Water pump (rear)			OM 366 * OM 366 A	6203 C3		BB
				6203 C3	000625900208	BB
Bomba hidráulica / Bomba hidráulica / Hydraulic pump				62204 2RS	0049819625	BB
Bomba injetora (dianteiro) / Bomba inyectora (delantero) / Injection pump (front)				30203 F	000720030203	TRB
Bomba injetora (traseiro) / Bomba inyectora (trasero) / Injection pump (rear)				30204 F	000720030204	TRB
Virabrequim / Cigüeñal / Crankshaft				6204 2RS / C3	000625406204	BB
Virabrequim - ponta / Cigüeñal - punta / Crankshaft spindle			OM 366 * OM 366 A	6204 2RS		BB

Tomada de Força / Toma de Fuerza / Power Take-off

Eixo de saída (traseiro) / Eje de salida (trasero) / Output shaft (rear)			4 S-120 GP + N 70/1B * 8 S-1350 + N 70/1B	6208 N		BB
Eixo intermediário (traseiro) / Eje intermedio (trasero) / Intermediate shaft (rear)			4 S-120 GP + N 70/1B * 8 S-1350 + N 70/1B	6009 C3		BB

Axor 2625 * 2628 * 2629 (LK*LS) * 2631 (B*K*L) * 2632 * 2635 (B*K*L) * 2635 (L*LK*LS) * 2635 * 2638 (L*LK*LS) * Axor 2640 * 2641 * 2643 * Axor 2644 * Actos 2646 * 2648 * 2650 * 2651 * 2653 * 2654 (L*LK*LS) * 2657 * 2658 * 2644 * Atego 2628 (B*K) * 2625 * Axor 2826 * Axor 2828 * Axor 2831

Eixo Dianteiro / Eje Delantero / Front Axle

Roda / Rueda / Wheel	•			32312 F	0119816805 / 0119816905	TRB
----------------------	---	--	--	----------------	----------------------------	-----

Eixo Traseiro / Eje Trasero / Rear Axle

Roda / Rueda / Wheel	•		745528/529	33020 F	0059818505	TRB
	•			33022 F	0049810905	TRB
	•		745528/529	33117 F	0059818605	TRB
	•			30220 F	0049814906	TRB
Diferencial - lateral coroa (dir./esq.) / Diferencial - lateral corona (der./izq.) / Diferencial - crown gear (right / left)			745528/29	32018 XF	0049814305	TRB
				33115 F	0039813005	TRB
Diferencial - pinhão (dianteiro) / Diferencial - piñón (delantero) / Differential - pinion (front)				31313 F	0059810505	TRB
Diferencial - pinhão (traseiro) / Diferencial - piñón (trasero) / Diferencial - pinion (rear)				32314 BF	0039813105	TRB

Embreagem / Embrague / Clutch

Apoio / Apoyo / Support			345913	6205 2RS	000625406205	BB
-------------------------	--	--	--------	-----------------	--------------	----

Caixa de Mudanças / Caja de Cambios / Gearbox

Eixo de acionamento / Eje de accionamiento / Drive shaft				F 19008		CRBS
Eixo intermediário (dianteiro) / Eje intermedio (delantero) / Intermediate shaft (front)				F 15047	0019801402	STRB
				33885 / 33822	0019809602	TRB
Eixo intermediário (entrada) / Eje intermedio (entrada) / Intermediate shaft (input)				F 15047	0019807802	STRB
Tomada de força / Toma de fuerza / Power take-off				6009 C3		BB

Motor / Motor / Engine

Alternador (dianteiro) / Alternador (delantero) / Alternator (front)				6303 2RS / C3	0049812425	BB
---	--	--	--	----------------------	------------	----

	OUT	IN		Fersa®	Nº OEM	
---	-----	----	---	---------------	--------	---

MERCEDES BENZ (SA)

Axor 2625 * 2628 * 2629 (LK*LS) * 2631 (B*K*L) * 2632 * 2635 (B*K*L) * 2635 (L*LK*LS) * 2635 * 2638 (L*LK*LS) * Axor 2640 * 2641 * 2643 * Axor 2644 * Actos 2646 * 2648 * 2650 * 2651 * 2653 * 2654 (L*LK*LS) * 2657 * 2658 * 2644 * Atego 2628 (B*K) * 2625 * Axor 2826 * Axor 2828 * Axor 2831

Motor / Motor / Engine

Alternador (traseiro) / Alternador (trasero) / Alternator (rear)				6201 2RS / C3	0089810705	BB
Alternador (traseiro) / Alternador (trasero) / Alternator (rear)				62201 2RS / C3	0029819025	BB
Bomba d'água (dianteiro) / Bomba de agua (delantero) / Water pump (front)			345913	6206	000625006206	BB
Bomba d'água (traseiro) / Bomba de agua (trasero) / Water pump (rear)			345913	NU 303 FM / C3	0019819601	CRB
Bomba injetora (dianteiro/traseiro) / Bomba inyectora (delantero/trasero) / Injection pump (front/rear)			345913	32205 F	000720032205	TRB
Compressor de ar (dianteiro) / Compresor de aire (delantero) / Air compressor (front)				NJ 305 FM / C3	005412400004	CRB

2629 LS

Caixa de Mudanças / Caja de Cambios / Gearbox

Corpo sincronizador (traseiro) / Cuerpo sincronizador (trasero) / Synchronizer (rear)			4 K 121 GP	6213 C3		BB
Eixo intermediário (dianteiro) / Eje intermedio (delantero) / Intermediate shaft (front)				33885 / 33822	0019809602	TRB
Eixo Intermediário (dianteiro/traseiro) / Eje Intermedio (delantero/trasero) / Intermediate shaft (front/rear)				33889 / 33822	0019809502	TRB
Eixo intermediário (saída) / Eje intermedio (salida) / Intermediate shaft (output)				32310 F	0019800102	TRB
Eixo primário / Eje primario / Primary shaft			718002	6208 N		BB
Eixo secundário (traseiro) / Eje secundario (trasero) / Secondary shaft (rear)			4 K 121 GP	NUP 311 FMNR / C3		CRB
Tomada de força / Toma de fuerza / Power take-off				6009 C3		BB

Eixo Traseiro / Eje Trasero / Rear Axle

Diferencial - coroa lateral (dir./esq.) / Diferencial - corona lateral (der./izq.) / Differential - crown gear (right/left)			745528/529	32018 XF		TRB
---	--	--	------------	-----------------	--	-----

Eixo Dianteiro / Eje Delantero / Front Axle

Roda / Rueda / Wheel	•			32310 F	0019817405	TRB
	•			32310 F		TRB
		•		F 15051 C	0059813105	STRB

Eixo Traseiro / Eje Trasero / Rear Axle

Roda / Rueda / Wheel				30220 F	0049814906	TRB
				32018 XF	0049814305	TRB
		•		33020 F	0059818505	TRB
				33022 F	0049810905	TRB
				33115 F	0039813005	TRB
				33117 F	0059818605	TRB
	•		745528/529	33117 F		TRB

Embreagem / Embrague / Clutch

Apoio / Apoyo / Support				6205 2RS	000625406205	BB
-------------------------	--	--	--	-----------------	--------------	----

Motor / Motor / Engine

Alternador (dianteiro) / Alternador (delantero) / Alternator (front)				6303 2RS / C3	0049812425	BB
Alternador (traseiro) / Alternador (trasero) / Alternator (rear)				6201 2RS / C3	0089810705	BB

	OUT	IN		Fersa®	N° OEM	
---	-----	----	---	---------------	--------	---

MERCEDES BENZ (SA)

2629 LS

Motor / Motor / Engine

Alternador (traseiro) / Alternador (trasero) / Alternator (rear)				62201 2RS / C3	00298190 (77...)25	BB
Bomba d'água (dianteiro) / Bomba de agua (delantero) / Water pump (front)				6206	000625006206	BB
Bomba d'água (traseiro) / Bomba de agua (trasero) / Water pump (rear)				NU 303 FM	0019819601	CRB
Bomba injetora (dianteiro/traseiro) / Bomba inyectora (delantero/trasero) / Injection pump (front/rear)				32205 F	000720032205	TRB
Compressor (dianteiro) / Compresor (delantero) / Compressor (front)			345913	NJ 305 C3		CRB
Compressor de ar (dianteiro) / Compresor de aire (delantero) / Air compressor (front)				NJ 305 FM / C3	005412400004	CRB

2635 (L*LK*LS)

Caixa de Mudanças / Caja de Cambios / Gearbox

Eixo intermediário (dianteiro) / Eje intermedio (delantero) / Intermediate shaft (front)				33885 / 33822	0019809602	TRB
			16 S-160	F 15047		STRB
Eixo Intermediário (dianteiro/traseiro) / Eje Intermedio (delantero/trasero) / Intermediate shaft (front/rear)				33889 / 33822	0019809502	TRB
Eixo intermediário (saída) / Eje intermedio (salida) / Intermediate shaft (output)				32310 F	0019800102	TRB
Eixo intermediário (traseiro) / Eje intermedio (trasero) / Intermediate shaft (rear)			16 S-160	32310 F		TRB
Tomada de força / Toma de fuerza / Power take-off				6009 C3		BB

Eixo Traseiro / Eje Trasero / Rear Axle

Diferencial - coroa lateral (dir./esq.) / Diferencial - corona lateral (der./izq.) / Differential - crown gear (right/left)			HD 7/016 DG-13/29:24 * HD 7/016 DG-13/4,2 * HD 7/014 DG-16/5,93 * HD 7/016 DG-13/4,64 * HD 7/013 DG-16/5,93 * HD 7/015 D-13	33115 F		TRB
Diferencial - divisor de torque (dianteiro) / Diferencial - divisor de par (delantero) / Differential - torque divisor (front)			HD 7/016 DG-13/29:24 * HD 7/016 DG-13/4,2 * HD 7/014 DG-16/5,93 * HD 7/016 DG-13/4,64 * HD 7/013 DG-16/5,93 * HD 7/015 D-	6313 C3		BB
Diferencial - divisor de torque (traseiro) / Diferencial - divisor de par (trasero) / Differential - torque divisor (rear)			HD 7/016 DG-13/29:24 * HD 7/016 DG-13/4,2 * HD 7/014 DG-16/5,93 * HD 7/016 DG-13/4,64 * HD 7/013 DG-16/5,93 * HD 7/015 D-13 *	6216 C3		BB
Diferencial - pinhão (dianteiro) / Diferencial - piñón (delantero) / Differential - pinion (front)			HD 7/016 DG-13/29:24 * HD 7/016 DG-13/4,2 * HD 7/014 DG-16/5,93 * HD 7/016 DG-13/4,64 * HD 7/013 DG-16/5,93 * HD 7/015 D	32313 F		TRB
Diferencial - pinhão (traseiro) / Diferencial - piñón (trasero) / Differential - pinion (rear)			HD 7/016 DG-13/29:24 * HD 7/016 DG-13/4,2 *	32314 BF		TRB

Eixo Dianteiro / Eje Delantero / Front Axle

Roda / Rueda / Wheel	•			32310 F	0019817405	TRB
		•		F 15051 C	0059813105	STRB

	OUT	IN		Fersa®	Nº OEM	
---	-----	----	---	---------------	--------	---

MERCEDES BENZ (SA)

2635 (L*LK*LS)

Eixo Traseiro / Eje Trasero / Rear Axle

Roda / Rueda / Wheel				30220 F	0049814906	TRB
				32018 XF	0049814305	TRB
		•		33020 F	0059818505	TRB
				33022 F	0049810905	TRB
				33115 F	0039813005	TRB
				33117 F	0059818605	TRB
				6312 C3	000625036312	BB
Suporte da mola (externo) / Resorte de apoyo (ext.) / Spring support (outner)				F 15076		STRB
Suporte da mola (interno) / Resorte de apoyo (interno) / Spring support (inner)				32022 XF		TRB

Embreagem / Embrague / Clutch

Apoio / Apoyo / Support				6205 2RS	000625406205	BB
-------------------------	--	--	--	-----------------	--------------	----

Motor / Motor / Engine

Alternador (dianteiro) / Alternador (delantero) / Alternator (front)			OM 447 LA	6303 RS / C3	0049812425	BB
Alternador (traseiro) / Alternador (trasero) / Alternator (rear)				6201 2RS / C3	0089810705	BB
				62201 2RS / C3	00298190 (77...)25	BB
Bomba d'água (dianteiro) / Bomba de agua (delantero) / Water pump (front)				6206	000625006206	BB
Bomba d'água (traseiro) / Bomba de agua (trasero) / Water pump (rear)				NU 303 FM	0019819601	CRB
Bomba injetora (dianteiro/traseiro) / Bomba inyectora (delantero/trasero) / Injection pump (front/rear)				32205 F	000720032205	TRB
Compressor de ar (dianteiro) / Compresor de aire (delantero) / Air compressor (front)				NJ 305 FM / C3	005412400004	CRB

312 (L*LK*LP) 51...58

Caixa de Mudanças / Caja de Cambios / Gearbox

Eixo intermediário / Eje intermedio / Intermediate shaft				30306 F	0019815705	TRB
				30306 F		TRB
Eixo primário / Eje primario / Primary shaft				NU 209 FMN	3449817101	CRB
				QJ 209 FM	3459817027	BB4PAC

Cardan / Cardan / Cardan

Suporte / Soporte / Support			LK	6208		BB
-----------------------------	--	--	----	-------------	--	----

Eixo Traseiro / Eje Trasero / Rear Axle

Diferencial - pinhão (traseiro) / Diferencial - piñón (trasero) / Differential - pinion (rear)				N 309 FM		CRB
--	--	--	--	-----------------	--	-----

Eixo Dianteiro / Eje Delantero / Front Axle

Roda / Rueda / Wheel		•		30312 F	0019819705	TRB
	•			32306 F	3129810205	TRB
				32307 F	0039816405	TRB

Eixo Traseiro / Eje Trasero / Rear Axle

Roda / Rueda / Wheel		•		32214 F	3129810001	TRB
----------------------	--	---	--	----------------	------------	-----

Embreagem / Embrague / Clutch

Apoio / Apoyo / Support				6204	000625006204	BB
-------------------------	--	--	--	-------------	--------------	----

Motor / Motor / Engine

Bomba d'água / Bomba de agua / Water pump				30302 F	000720030202	TRB
Compressor de ar / Compresor de aire / Air compressor				6305	000625006305	BB
Ventilador / Ventilador / Fan				30302 F	000720030202	TRB

	OUT	IN		Fersa®	N° OEM	
---	-----	----	---	---------------	--------	---

MERCEDES BENZ (SA)

312 (L*LK*LP) 51...58

Tomada de Força / Toma de Fuerza / Power Take-off

Engrenagem intermediária (dianteiro) / Engranaje intermedio (delantero) / Intermediate gear (front)			LK	32306 F		TRB
Engrenagem intermediária (traseiro) / Engranaje intermedio (traseiro) / Intermediate gear (rear)			LK	32305 F		TRB

Tomada de Potência / Toma de Potencia / Power Take-off

Eixo de saída (dianteiro) / Eje de salida (delantero) / Output shaft (front)				NJ 304 FMN	005412400304	CRB
Eixo intermediário (dianteiro) / Eje intermedio (delantero) / Intermediate shaft (front)				32306 F	003129810205	TRB
Eixo intermediário (traseiro) / Eje intermedio (traseiro) / Intermediate shaft (rear)				32305 F	007200032305	TRB

321 (LAP*LAPK*LAPS*LP* LPK*LPS) 51...71

Caixa de Mudanças / Caja de Cambios / Gearbox

Eixo de entrada / Eje de entrada / Input shaft				QJ 209 FM		BB4PAC
Eixo de entrada (dianteiro) / Eje de entrada (delantero) / Input shaft (front)				30308 F		TRB
Eixo de entrada (traseiro) / Eje de entrada (traseiro) / Input shaft (rear)				30309 F		TRB
Eixo de saída (dianteiro/traseiro) / Eje de salida (delantero/traseiro) / Output shaft (front-rear)				6309 Z / C3		BB
Eixo intermediário / Eje intermedio / Intermediate shaft				30309 F		TRB
				30308 F		TRB
Eixo secundário (traseiro) / Eje secundario (traseiro) / Secondary shaft (rear)				QJ 309 FM		BB4PAC

Eixo Traseiro / Eje Trasero / Rear Axle

Diferencial - coroa lateral (dir./esq.) / Diferencial - corona lateral (der./izq.) / Differential - crown gear (right/left)			LAP * LAPK * LAPS	32212 F		TRB
---	--	--	-------------------	---------	--	-----

Eixo Dianteiro / Eje Delantero / Front Axle

Roda / Rueda / Wheel		•	LP * LPK * LPS	30312 F		TRB
		•	LP * LPK * LPS	32307 F		TRB

Eixo Traseiro / Eje Trasero / Rear Axle

Roda / Rueda / Wheel		•		32216 F		TRB
----------------------	--	---	--	---------	--	-----

Embreagem / Embrague / Clutch

Apoio / Apoyo / Support				6204		BB
-------------------------	--	--	--	------	--	----

Motor / Motor / Engine

Bomba d'água - rolam / Bomba de agua - rodam. / Water pump - bearing				30302 F		TRB
Polia tensora - rolam. / Polea tensora - rodam. / Tensioner pulley - bearing				6302		BB

Tomada de Força / Toma de Fuerza / Power Take-off

Eixo de saída (dianteiro) / Eje de salida (delantero) / Output shaft (front)			LPK * LAPK	6007		BB
Eixo de saída (traseiro) / Eje de salida (traseiro) / Output shaft (rear)			LPK * LAPK	6206		BB

321 (LAP * LAPK * LAPS * LP * LPK * LPS)

Caixa de Mudanças / Caja de Cambios / Gearbox

Eixo intermediário / Eje intermedio / Intermediate shaft				30308 F	0019813105 / 0019815005	TRB
Eixo Intermediário (dianteiro/traseiro) / Eje Intermedio (delantero/traseiro) / Intermediate shaft (front/rear)				30309 F	00198113705	TRB

	OUT	IN		Fersa®	Nº OEM	
---	-----	----	---	---------------	--------	---

MERCEDES BENZ (SA)

321 LAP * LAPK * LAPS * LP * LPK * LPS

Caixa de Mudanças / Caja de Cambios / Gearbox

Eixo primário / Eje primario / Primary shaft				NU 209 FMN	3449817101	CRB
				QJ 209 FM	3459817027	BB4PAC
Eixo primário inf. (dianteiro/traseiro) / Eje primario inf. (delantero/trasero) / Primary shaft (front/rear)				6308 ZNR / C3	3129811325	BB
Eixo primário inf. (traseiro) / Eje primario inf. (trasero) / Primary shaft (rear)				NJ 2211 FM	000628000339	CRB
Eixo primário sup. (dianteiro/traseiro) / Eje primario sup. (delantero/trasero) / Upper primary shaft (front/rear)				30308 F	0019813105 / 0019815005	TRB
Eixo secundário (traseiro) / Eje secundario (trasero) / Secondary shaft (rear)				QJ 309 FM	0009813105	BB4PAC

Eixo Traseiro / Eje Trasero / Rear Axle

Diferencial - lateral coroa / Diferencial - lateral corona / Differential - crown gear				32212 F	3129810101	TRB
--	--	--	--	----------------	------------	-----

Eixo Dianteiro / Eje Delantero / Front Axle

Roda / Rueda / Wheel		•		30312 F	0019819705	TRB
	•			32307 F	0039816405	TRB

Eixo Traseiro / Eje Trasero / Rear Axle

Roda / Rueda / Wheel		•		32216 F	0009817205	TRB
----------------------	--	---	--	----------------	------------	-----

Embreagem / Embrague / Clutch

Apoio / Apoyo / Support				6204	000625006204	BB
-------------------------	--	--	--	-------------	--------------	----

Motor / Motor / Engine

Bomba d'água / Bomba de agua / Water pump				30302 F	000720030202	TRB
Polia tensora / Polea tensora / Tensioner pulley				6302	000625006302	BB

Tomada de Potência / Toma de Potencia / Power Take-off

Eixo de saída (dianteiro) / Eje de salida (delantero) / Output shaft (front)				6007	000625006007	BB
Eixo de saída (traseiro) / Eje de salida (trasero) / Output shaft (rear)				6206	000625006206	BB

3238 (6x4) K * S

Eixo Dianteiro / Eje Delantero / Front Axle

Roda / Rueda / Wheel	•			32312 F	011 981 6905	TRB
		•		F 15051 C	005 981 3105	STRB

Eixo Traseiro / Eje Trasero / Rear Axle

Roda / Rueda / Wheel	•			30220 F	004 981 2105	TRB
		•		33022 F	004 981 0905	TRB

331 (L*LPK*LPS) 60...68

Caixa de Mudanças / Caja de Cambios / Gearbox

Eixo intermediário (dianteiro) / Eje intermedio (delantero) / Intermediate shaft (front)				6310 C3		BB
				6310 C3	000625006310	BB
Eixo intermediário / Eje intermedio / Intermediate shaft				NUP 212 FM		CRB
Eixo secundário (dianteiro) / Eje secundario (delantero) / Secondary shaft (front)				NUP 311 FM		CRB
Eixo secundário (traseiro) / Eje secundario (trasero) / Secondary shaft (rear)				6311 C3		BB

Cardan / Cardan / Cardan

Suporte / Soporte / Support				6210	000625006210	BB
			LPK * LPS	6208		BB
			LP	6210		BB

	OUT	IN		Fersa®	N° OEM	
---	-----	----	---	---------------	--------	---

MERCEDES BENZ (SA)

331 (L*LPK*LPS) 60...68

Eixo Traseiro / Eje Trasero / Rear Axle

Diferencial - coroa lateral (dir.) / Diferencial - corona lateral (der.) / Differential - crown gear (right)			...64	30216 F		TRB
Diferencial - coroa lateral (esq.) / Diferencial - coroa lateral (izq.) / Differential - crown gear (left)			...64	32216 F		TRB
Diferencial - pinhão (dianteiro) / Diferencial - piñón (delantero) / Differential - pinion (front)			65...	HM 807046 / HM 807010		TRB
Diferencial - pinhão (dianteiro/traseiro) / Diferencial - piñón (delantero/traseiro) / Differential - pinion (front/rear)			...64	31311 F		TRB

Eixo Dianteiro / Eje Delantero / Front Axle

Roda / Rueda / Wheel		•		30313 F		TRB
		•		30313 F	000720030313	TRB
	•			32309 F	0049811305	TRB

Eixo Traseiro / Eje Trasero / Rear Axle

Roda / Rueda / Wheel	•			32218 F	000720032218	TRB
		•		32219 F	0009812105	TRB
	•		65...	580 / 572	0039811405	TRB

Embreagem / Embrague / Clutch

Apoio / Apoyo / Support				6205		BB
				6205	000625006205	BB

Motor / Motor / Engine

Bomba d'água (dianteiro) / Bomba de agua (delantero) / Water pump (front)				6204	000625006204	BB
Bomba d'água (traseiro) / Bomba de agua (trasero) / Water pump (rear)				6004	000625006004	BB
Bomba injetora (dianteiro) / Bomba inyectora (delantero) / Injection pump (front)				6305	000625006305	BB
Bomba injetora (traseiro) / Bomba inyectora (trasero) / Injection pump (rear)				6205	000625006205	BB
Compressor / Compresor / Compressor				6305		BB
Compressor de ar / Compresor de aire / Air compressor				6305	000625006305	BB
Dínamo (dianteiro) / Dinamo (delantero) / Dynamo (front)				6204	000625006004	BB
Dínamo (traseiro) / Dinamo (trasero) / Dynamo (rear)				6004	000625006204	BB
Ventilador (dianteiro) / Ventilador (delantero) / Fan (front)				30204 F	000720030204	TRB
Ventilador (traseiro) / Ventilador (trasero) / Fan (rear)				30205 F	000720030205	TRB

Tomada de Potência / Toma de Potencia / Power Take-off

Eixo de saída (traseiro) / Eje de salida (trasero) / Output shaft (rear)				6208	000625006208	BB
--	--	--	--	-------------	--------------	----



615 (LO) * 715 C

Eixo Dianteiro / Eje Delantero / Front Axle

Roda / Rueda / Wheel	•			33207 F	005 981 0705	TRB
----------------------	---	--	--	----------------	--------------	-----

Eixo Traseiro / Eje Trasero / Rear Axle

Roda / Rueda / Wheel		•		32011 XF	002 981 6605	TRB
	•			32014 XF	005 981 6605	TRB

	OUT	IN		Fersa®	Nº OEM	
---	-----	----	---	---------------	--------	---

SCANIA (NA & CA)

LA 94 UB 4X2 LB * LA 6X4 NA

Caixa de Mudanças / Caja de Cambios / Gearbox

Flecha principal - flecha intermediária (direito e (esq.) / Flecha principal - flecha intermedia derecho e (izq.) / Main shaft & intermediate shaft (right/left)				30314 F		TRB
--	--	--	--	----------------	--	-----

Eixo Traseiro / Eje Trasero / Rear Axle

Diferencial (dir.) / Diferencial (der.) / Differential (right)				JM 720249 / JM 720210		TRB
Diferencial - (esq.) / Diferencial - (izq.) / Differential (left)				33017 F		TRB
Diferencial - pinhão cola / Diferencial - piñón cola / Differential - pinion (rear)				30312 F	1523056	TRB
				31312 F	7181609	TRB

P 114 CB 6X4 NA 340

Caixa de Mudanças / Caja de Cambios / Gearbox

Flecha primaria e secundária (dir.) / Flecha primaria y secundaria (der.) / Primary and secondary shaft (right)				30314 F		TRB
---	--	--	--	----------------	--	-----

Eixo Traseiro / Eje Trasero / Rear Axle

Diferencial - eixo (traseiro) / Diferencial - eje (trasero) / Differential - rear shaft				33018 F		TRB
				31312 F	7181609	TRB
Diferencial (dir.) / Diferencial (der.) / Differential (right)				JM 720249 / JM 720210		TRB
Diferencial - (esq.) / Diferencial - (izq.) / Differential (left)				33017 F		TRB
Diferencial - pinhão cola (flecha intermediária direito) / Diferencial - piñón cola (flecha intermedia derecho) / Differential - pinion rear intermediate shaft (right)				30312 F	1523056	TRB

P 94 CB (6X4*6x2*4x2)

Eixo Dianteiro / Eje Delantero / Front Axle

Roda / Rueda / Wheel	•			32308 F		TRB
----------------------	---	--	--	----------------	--	-----

Eixo Traseiro / Eje Trasero / Rear Axle

Diferencial - eixo (traseiro) / Diferencial - eje (trasero) / Differential - rear shaft				33018 F		TRB
				31312 F	7181609	TRB
Roda / Rueda / Wheel	•			HM 218248 / HM 218210	291060	TRB
		•		HM 218248 / HM 218210	291060	TRB

P 94 DB 4X2 NA 220 * P 94 DB 6X2 NA260

Caixa de Mudanças / Caja de Cambios / Gearbox

Flecha primaria e secundária (dir.) / Flecha primaria y secundaria (der.) / Primary and secondary shaft				30314 F		TRB
--	--	--	--	----------------	--	-----

Eixo Dianteiro / Eje Delantero / Front Axle

Roda / Rueda / Wheel	•			32308 F		TRB
----------------------	---	--	--	----------------	--	-----

Eixo Traseiro / Eje Trasero / Rear Axle

Diferencial - flecha intermediária (dir.) / Diferencial - flecha intermedia (der.) / Differential - intermediate shaft (right)				30312 F	1523056	TRB
Roda / Rueda / Wheel	•			HM 218248 / HM 218210	291060	TRB
		•		HM 218248 / HM 218210	291060	TRB

R 114 LA 4X2 NA340

Caixa de Mudanças / Caja de Cambios / Gearbox

Flecha primaria e secundária (dir.) / Flecha primaria y secundaria (der.) / Primary and secondary shaft				30314 F		TRB
--	--	--	--	----------------	--	-----

	OUT	IN		Fersa®	N° OEM	
---	-----	----	---	---------------	--------	---

SCANIA (NA & CA)

R 114 LA 4X2 NA340

Eixo Traseiro / Eje Trasero / Rear Axle

Diferencial - flecha intermediária (dir.) / Diferencial - flecha intermedia (der.) / Differential - intermediate shaft (right)				30312 F	1523056	TRB
--	--	--	--	----------------	---------	-----

R 124 GA 4X2 NA400

Caixa de Mudanças / Caja de Cambios / Gearbox

Flecha primaria e secundária (dir.) / Flecha primaria y secundaria (der.) / Primary and secondary shaft				30314 F		TRB
--	--	--	--	----------------	--	-----

Eixo Dianteiro / Eje Delantero / Front Axle

Roda / Rueda / Wheel	•			32308 F		TRB
----------------------	---	--	--	----------------	--	-----

Eixo Traseiro / Eje Trasero / Rear Axle

Diferencial - eixo (traseiro) / Diferencial - eje (trasero) / Differential - rear shaft				33018 F		TRB
				31312 F	7181609	TRB
Diferencial - flecha intermediária (dir.) / Diferencial - flecha intermedia (der.) / Differential - intermediate shaft (right)				30312 F	1523056	TRB
Diferencial (dir.) / Diferencial (der.) / Differential (right)				JM 720249 / JM 720210		TRB
Diferencial - (esq.) / Diferencial - (izq.) / Differential (left)				33017 F		TRB
Diferencial - pinhão cola / Diferencial - piñón cola / Differential - pinion (rear)				30312 F	1523056	TRB
Roda / Rueda / Wheel	•			HM 218248 / HM 218210	291060	TRB
		•		HM 218248 / HM 218210	291060	TRB

T 124 GA 6X4 * T 124 LA 6X4 NA400

Caixa de Mudanças / Caja de Cambios / Gearbox

Flecha primaria e secundária (dir.) / Flecha primaria y secundaria (der.) / Primary and secondary shaft (right)				30314 F		TRB
---	--	--	--	----------------	--	-----

Eixo Dianteiro / Eje Delantero / Front Axle

Roda / Rueda / Wheel	•			32308 F		TRB
----------------------	---	--	--	----------------	--	-----

Eixo Traseiro / Eje Trasero / Rear Axle

Diferencial - eixo (traseiro) / Diferencial - eje (trasero) / Differential - rear shaft				33018 F		TRB
Diferencial - (dir./esq.) / Diferencial - (der./izq.) / Differential (right/left)				JM 720249 / JM 720210		TRB
			R660 * RB 660	33017 F		TRB
Diferencial - pinhão cola / Diferencial - piñón cola / Differential - pinion (rear)			R660 * RB 660	30312 F	1523056	TRB
Diferencial - pinhão cola (eixo traseiro) / Diferencial - piñón cola (eje trasero) / Differential - pinion (rear axle)				31312 F	7181609	TRB
Diferencial - pinhão cola (flecha intermediária direito) / Diferencial - piñón cola (flecha intermedia derecho) / Differential - pinion rear intermediate shaft (right)				30312 F	1523056	TRB
Roda / Rueda / Wheel	•			HM 218248 / HM 218210	291060	TRB
		•		HM 218248 / HM 218210	291060	TRB



	OUT	IN		Fersa®	Nº OEM	
---	-----	----	---	---------------	--------	---

SCANIA (SA)

112 (F*K*S)

Caixa de Mudanças / Caja de Cambios / Gearbox

Eixo secundário (dianteiro) / Eje secundario (delantero) / Secondary shaft (front)			770/G 776	33208 F	284843	TRB
--	--	--	-----------	---------	--------	-----

Cardan / Cardan / Cardan

Suporte / Soporte / Support			TA 60	6211	14093	BB
-----------------------------	--	--	-------	------	-------	----

Eixo Dianteiro / Eje Delantero / Front Axle

Roda / Rueda / Wheel	•			32308 F	14698	TRB
	•			32309 F	14623	TRB
		•		32311 F	179427	TRB
		•		32312 F	14836	TRB

Eixo Traseiro / Eje Trasero / Rear Axle

Diferencial - coroa lateral (dir./esq.) / Diferencial - corona lateral (der./izq.) / Differential - crown gear (right/left)			R 653	30217 F		TRB
			R 752/R 770	30217 F	174717	TRB
Diferencial - coroa lateral (esq.) / Diferencial - corona lateral (izq.) / Differential - crown gear (left)			R 752	32022 XF		TRB
				31312 F	174716	TRB
Diferencial - pinhão (dianteiro) / Diferencial - piñón (delantero) / Differential - pinion (front)			R 752 * R 770	F 15046		STRB
				F 15046	194050	STRB
				32315 BF	194137	TRB
Diferencial - pinhão (traseiro) / Diferencial - piñón (trasero) / Differential - pinion (rear)			R 653	F 15046		STRB
				F 15046	194050	STRB
				32020 XF	274114	TRB
Roda / Rueda / Wheel				32218 F	14835	TRB
				HM 218248 / HM 218210	291060/ 1524625	TRB

Embreagem / Embrague / Clutch

Apoio / Apoyo / Support				6305 2RS		BB
				6305 2RS	168248	BB
Desengate / Desembrague / Clutch				6212	14831	BB
				6014 2RS		BB
				6014 2RS	215139	BB

Motor / Motor / Engine

Alternador (dianteiro) / Alternador (delantero) / Alternator (front)				6303 2RS / C3	220137	BB
Alternador (dianteiro, 35 A) / Alternador (delantero, 35 A) / Alternator - 35 A (front)				6303 2RS / C3		BB
Alternador (dianteiro, 45 A) / Alternador (delantero, 45 A) / Alternator - 45 A (front)				6403 2RS / C3		BB
Alternador (traseiro, 35 A) / Alternador (trasero, 35 A) / Alternator - 35 A (rear)				62201 2RS / C3		BB
Bomba d'água (dianteiro) / Bomba de agua (delantero) / Water pump (front)				6205 2RS / C3	2288365	BB
Bomba d'água (traseiro) / Bomba de agua (trasero) / Water pump (rear)				6305 2RS / C3	258267	BB
Bomba de óleo / Bomba de aceite / Oil pump				6304	240288/152897	BB
Bomba direção / Bomba de dirección / Direction pump				6004	144280	BB
Bomba injetora (dianteiro) / Bomba inyectora (delantero) / Injection pump (front)				6207 C3	14091	BB

	OUT	IN		Fersa [®]	N° OEM	
---	-----	----	---	---------------------------	--------	---

SCANIA (SA)

112 (F*K*S)

Motor / Motor / Engine

Bomba injetora (traseiro) / Bomba inyectora (trasero) / Injection pump (rear)				6007	140180	BB
Compressor de ar (dianteiro) / Compresor de aire (delantero) / Air compressor (front)				6207 C3	14091	BB
Compressor de ar (traseiro) / Compresor de aire (trasero) / Air compressor (rear)				6011 C3	141930	BB
Polia tensora / Polea tensora / Tensioner pulley				6205 2RS	228836	BB
Ventilador / Ventilador / Fan				6305 2RS	168248	BB
Virabrequim - ponta / Cigüeñal - punta / Crankshaft spindle				6305 2RS	168248	BB

Tomada de Força / Toma de Fuerza / Power Take-off

Eixo de saída (dianteiro) / Eje de salida (delantero) / Output shaft (front)				32306 F	14614	TRB
Eixo de saída (traseiro) / Eje de salida (trasero) / Output shaft (rear)				32208 F	214104	TRB

75 * 76 B * L * LS

Caixa de Mudanças / Caja de Cambios / Gearbox

Caixa auxiliar - eixo entrada (dianteiro) / Caja auxiliar - eje entrada (delantero) / Auxiliar box - input shaft (front)			G 660	6411 NR / C3		BB
Caixa auxiliar - eixo intermediário (dianteiro) / Caja auxiliar - eje intermedio (delantero) / Auxiliar box - intermediate shaft (front)			G 660	6409 NR / C3		BB
Caixa auxiliar - eixo saída (traseiro) / Caja auxiliar - eje salida (trasero) / Auxiliar box - output shaft (rear)			G 660	6311 NR / C3		BB
Eixo intermediário (dianteiro) / Eje intermedio (delantero) / Intermediate shaft (front)			G 655 * G 505	6407 C3		BB
			G 660/670/671/672	6409 C3		BB
Eixo intermediário (dir.) / Eje intermedio (der.) / Intermediate shaft (right)			310 - GR 801 K 94 IB (4X2) NB * GR 801 P 94 CB (6X4) 260 * P 94 DB (6X2) * P 94 GA/GB (4X2) 260 * P 94 DB (4X2) 220/260	30312 F		TRB
Eixo intermediário (traseiro) / Eje intermedio (trasero) / Intermediate shaft (rear)				6309 ZNR / C3	14096	BB
			G 660/670/671/672	6409 NR / C3		BB
Eixo primário / Eje primario / Primary shaft			310 - GR 801 K 94 IB (4X2) NB * GR 801 P 94 CB (6X4) 260 * P 94 DB (6X2), P 94 GA/GB (4X2) 260 * P 94 DB (4X2) 220/260	30314 F		TRB
			G 655/G 505	6311 NR / C3		BB
			G 660/670/671/672	6411 NR / C3		BB
Eixo secundário (dir.) / Eje secundario (der.) / Secondary shaft (right)			310 - GR 801 K 94 IB (4X2) NB * GR 801 P 94 CB (6X4) 260 * P 94 DB (6X2), P 94 GA/GB (4X2) 260 * P 94 DB (4X2) 220/260	30314 F		TRB
			G 655/G 505	6311 NR / C3		BB
Eixo secundário (traseiro) / Eje secundario (trasero) / Secondary shaft (rear)			G 660/670/671/672	6411 NR / C3		BB
			G 670/671/672	6015 Z		BB
Planetário - eixo de saída (dianteiro) / Planetario - eje de salida (delantero) / Planetary - output shaft (front)			G 670/671/672	6015 Z		BB
Planetário - eixo de saída (traseiro) / Planetario - eje de salida (trasero) / Planetary - output shaft (rear)			G 670/671/672	6311		BB

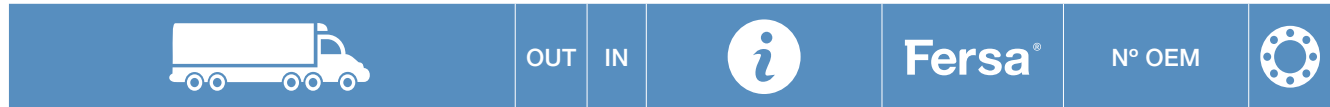

SCANIA (SA)

75 * 76 B * L * LS

Cardan / Cardan / Cardan

Apoio / Apoyo / Support			G 655 * G 505	6211		BB
Suporte / Soporte / Support				6211	14093	BB

Eixo / Eje / Axle

Caixa sat.lat. (dir.) / Caja sat.lat. (der.) / Satellit box (right)				32313 BF	144710	TRB
Pinhão cônico (dianteiro/traseiro) / Piñón cónico (delantero/trasero) / Bevel gear (front/rear)				31312 F	174716	TRB
Pinhão cônico (traseiro) / Piñón cónico trasero / Bevel gear (rear)				31314 F	174961	TRB

Eixo Dianteiro / Eje Delantero / Front Axle

Roda / Rueda / Wheel				31309 F	14834	TRB
	•			32308 F	14698	TRB
		•		32311 F	179427	TRB

Eixo Traseiro / Eje Trasero / Rear Axle

Diferencial - caixa satélite lat. (dir.) / Diferencial - caja satélite - lat. (der.) / Differential - satellit box (right)				32313 BF		TRB
Diferencial - coroa lateral (dir./esq.) / Diferencial - corona lateral (der./izq.) / Differential - crown gear (right/left)				30217 F		TRB
				30217 F	174631	TRB
Diferencial - eixo reduzida (dir./esq.) / Diferencial - eje reducción (der./izq.) / Differential - reduction shaft (right/left)				30217 F		TRB
Diferencial - pinhão (dianteiro) / Diferencial - piñón (delantero) / Differential - pinion (front)				31312 F		TRB
				31312 F	174716	TRB
Diferencial - pinhão (dianteiro/traseiro) / Diferencial - piñón (delantero/trasero) / Differential - pinion (front/rear)				31312 F		TRB
Diferencial - pinhão (traseiro) / Diferencial - piñón (trasero) / Differential - pinion (rear)				31314 F		TRB
Roda / Rueda / Wheel				32218 F	14835	TRB

Embreagem / Embrague / Clutch

Alavanca de acionamento / Palanca de accionamiento / Drive lever				6201 ZZ		BB
Apoio / Apoyo / Support				6305 2RS	168248	BB

Motor / Motor / Engine

Alternador (dianteiro) / Alternador (delantero) / Alternator (front)				6202 Z / C3		BB
Alternador (traseiro) / Alternador (trasero) / Alternator (rear)				6201 Z / C3	210998	BB
Bomba d'água (dianteiro) / Bomba de agua (delantero) / Water pump (front)			L * LS * B 75	6204	14089	BB
			L * LS * B 75	6305 2RS	33108	BB
Bomba d'água (traseiro) / Bomba de agua (trasero) / Water pump (rear)				6205 2RS / C3	14090	BB
Bomba de óleo / Bomba de aceite / Oil pump				6304	152897	BB
Bomba injetora (dianteiro) / Bomba inyectora (delantero) / Injection pump (front)				6207 C3	14091	BB
Bomba injetora (traseiro) / Bomba inyectora (trasero) / Injection pump (rear)				6207 NR	132649	BB
Compressor de ar (dianteiro) / Compresor de aire (delantero) / Air compressor (front)				6207 C3	14091	BB
Compressor de ar (traseiro) / Compresor de aire (trasero) / Air compressor (rear)				6011 C3	141930	BB

	OUT	IN		Fersa®	N° OEM	
---	-----	----	---	---------------	--------	---

SCANIA (SA)

75 * 76 B * L * LS

Motor / Motor / Engine

Polia tensora / Polea tensora / Tensioner pulley			B 75 * 76	6205 2RS	139246	BB
--	--	--	-----------	-----------------	--------	----

Tomada de Força / Toma de Fuerza / Power Take-off

Eixo de saída (dianteiro) / Eje de salida (delantero) / Output shaft (front)			G 660	6207 C3		BB
Eixo intermediário (traseiro) / Eje intermedio (trasero) / Intermediate shaft (rear)			G 660	6208		BB

94I * 94H * 94U * P94 CB (6x4*4x2) * 114L * P114 * T114 CB (6x4*4x2) * 124E * R124 * K124 CA (6x4*6x2) * T124 * P124 CA * CB (6x4*4x2) * 164 * P230 * P270 * P310 * P340 * P420 * R380 * R420 * R480

Caixa de Mudanças / Caja de Cambios / Gearbox



Eixo principal / Eje principal / Main shaft				JF 4049 / JF 4010	380096	TRB
				JD 6549 / JD 6510	392996	TRB
				6312 C3	1304315	BB
Eixo intermediário / Eje intermedio / Intermediate shaft				JF 5049 / JF 5010	374330	TRB
Eixo secundário / Eje secundario / Secondary shaft				JF 4049 / JF 4010	380096	TRB
				JF 5049 / JF 5010	374330	TRB
Planetária / Planetario / Planetary				6312 C3	1304315	BB
Planetária / Planetario / Planetary				JF 4049 / JF 4010	361043	TRB

Eixo Dianteiro / Eje Delantero / Front Axle

Roda / Rueda / Wheel		•	AM60	32312 F	14623	TRB
	•		AM60	32309 F	14836	TRB
	•		AM55	32308 F	14698	TRB

Eixo Traseiro / Eje Trasero / Rear Axle

Roda / Rueda / Wheel		•		32021 XF	1415140	TRB
	•	•	AD1100P, AD/ ADA 1300, AD90, AS90 * AD 8x20	HM 218248 / HM 218210	291060	TRB
				JF 10049 / JF 10010	383343	TRB
Balança / Equilibrio / Balance				32308 BF	322747	TRB
Braço de balanço (direito) / Brazo de equilibrio (der.) / Swingarm (right)				32220 F	123630	TRB
Braço de balanço (esquerdo) / Brazo de equilibrio (izq.) / Swingarm (left)				32316 F	123629	TRB
Braço de balanço (jumelo) / Brazo de equilibrio (jumelo) / Swingarm jumel				32207 F	202635	TRB
Carcaça de la redução / Carcasa de reducción / Reduction housing				33212 F	345833	TRB
Eixo secundário / Eje secundario / Secondary shaft				JF 4049 / JF 4010	380096	TRB
Diferencial - ponta do pinhão / Diferencial - punta de piñón / Differential - pinion				F 19076	1331313	CRBS
				N 2211 FMNR / C3	1331313	CRB
				F 19001	1309569	CRBS
Diferencial - direito / Diferencial - corona derecho / Differential - crown (right)				33017 F	1364631	TRB
				33018 F	1309570	TRB
Diferencial - esquerdo / Diferencial - corona (izq.) / Differential - crown (left)				JM720249 / JM720210	1105776	TRB
				JHM 522649 / JHM 522610	1309568	TRB
Diferencial - pinhão (externo) / Diferencial - piñón (externo) / Differential - pinion (outer)				31312 F	174716	TRB
				33212 F	345833	TRB
			R 780, R 782, RP 831, RP 832 * RP 835	H 913842 / H 913810	264700	TRB

	OUT	IN		Fersa®	Nº OEM	
---	-----	----	---	---------------	--------	---

SCANIA (SA)

94I * 94H * 94U * P94 CB 6x4 e* y 4x2 * 114L * P114 * T114 CB 6x4 e* y4x2 * 124E * R124 * K124 CA 6x4 e / y 6x2 * T124 * P124 CA e / y CB 6x4 e / y 4x2 * 164 * P230 * P270 * P310 * P340 * P420 * R380 * R420 * R480

Eixo Traseiro / Eje Trasero / Rear Axle

Diferencial - pinhão (interno) / Diferencial - piñón (interno) / Differential - pinion (inner)				F 15048	315465	STRB
Diferencial - engrenagem central / Diferencial - engranaje central / Differential - central gear				32020 XF	1364630	TRB
				F 15048	345465	STRB
Diferencial - conjunto da redução (apoio direito / esquerdo da coroa) / Diferencial - conjunto de la reducción (apoyo derecho / (izq.) de la corona) / Differential - reduction assembly support crown (right/left)				32016 XF	1301682	TRB
Eixo de apoio - suspensão / Eje de apoyo suspensión / Support axle - suspension			AS90	HM 218248 / HM 218210	291060	TRB

Diversos

Caixa de Mudanças / Caja de Cambios / Gearbox

Eixo intermediário / Eje intermedio / Intermediate shaft				F 15047	0019801402	STRB
				F 19010	0735410076	CRBS
				F 19039	0735410136	CRBS

F 113 * L 113 * K 113

Caixa de Mudanças / Caja de Cambios / Gearbox

Eixo secundário (dianteiro) / Eje secundario (delantero) / Secondary shaft (front)				33208 F	284843	TRB
--	--	--	--	----------------	--------	-----

Cardan / Cardan / Cardan

Suporte / Soporte / Support				6211	14093	BB
-----------------------------	--	--	--	-------------	-------	----

Direção / Dirección / Steering

Bomba / Bomba / Pump				6004	144280	BB
----------------------	--	--	--	-------------	--------	----

Eixo Dianteiro / Eje Delantero / Front Axle

Roda / Rueda / Wheel	•			32308 F	14698	TRB
	•			32309 F	14623	TRB
		•		32311 F	179427	TRB
		•		32312 F	14836	TRB

Eixo Traseiro / Eje Trasero / Rear Axle

Diferencial - coroa lateral (dir./esq.) / Diferencial - corona lateral (der./izq.) / Differential - crown gear (right/left)				30217 F	174717	TRB
Diferencial - lateral coroa esq. / Diferencial - lateral corona (izq.) / Differential - crown gear (left)				JHM 522649 / JHM 522610	1309568	TRB
Diferencial - pinhão (dianteiro) / Diferencial - piñón (delantero) / Differential - pinion (front)				31312 F	174716	TRB
				F 15046	194050	STRB
Diferencial - pinhão (traseiro) / Diferencial - piñón (trasero) / Differential - pinion (rear)				F 15048	315465	STRB
				32020 XF	274114	TRB
Roda / Rueda / Wheel				32218 F	14835	TRB
	•			32308 F	14698	TRB
				32309 F	14623	TRB
		•		32311 F	179427	TRB
		•		32312 F	14836	TRB

Embreagem / Embrague / Clutch

Desengate / Desembrague / Clutch				6014 2RS	215139	BB
----------------------------------	--	--	--	-----------------	--------	----

	OUT	IN		Fersa®	N° OEM	
---	-----	----	---	---------------	--------	---

SCANIA (SA)

F 113 * L 113 * K 113

Motor / Motor / Engine

Bomba d'água (dianteiro) / Bomba de agua (delantero) / Water pump (front)				6305 2RS / C3	258267	BB
Bomba d'água (traseiro) / Bomba de agua (trasero) / Water pump (rear)				6205 2RS	228836	BB
Bomba de óleo / Bomba de aceite / Oil pump				6004	144280	BB
				6304	152897	BB
Bomba injetora (dianteiro) / Bomba inyectora (delantero) / Injection pump (front)				6207 C3	14091	BB
Bomba injetora (traseiro) / Bomba inyectora (trasero) / Injection pump (rear)				6007	140180	BB
Polia tensora / Polea tensora / Tensioner pulley				6205 2RS	228836	BB
Virabrequim - ponta / Cigüeñal - punta / Crankshaft spindle				6305 2RS	168248	BB

Tomada de Força / Toma de Fuerza / Power Take-off

Eixo de saída (dianteiro) / Eje de salida (delantero) / Output shaft (front)				32306 F	14614	TRB
Eixo de saída (traseiro) / Eje de salida (trasero) / Output shaft (rear)				32208 F	214104	TRB

P 114 * R 124 * T 114 CB 6x4 e 4x2 * T 124

Caixa de Mudanças / Caja de Cambios / Gearbox

Eixo principal / Eje principal / Main shaft				6312 C3	1304315	BB
Planetária / Planetario / Planetary				6312 C3	1304315	BB

Eixo Dianteiro / Eje Delantero / Front Axle

Roda / Rueda / Wheel				32308 BF	1382900	TRB
	•			32308 F	14698	TRB
	•			32309 F	14836	TRB
		•		32311 F	179427	TRB
		•		32312 F	14623	TRB

Eixo Traseiro / Eje Trasero / Rear Axle

Diferencial - coroa (dir.) / Diferencial - corona (der.) / Differential - crown (right)				33017 F	1364631	TRB
				33018 F	1309570	TRB
Diferencial - coroa (esq.) / Diferencial - corona (izq.) / Differential - crown (left)				JHM 522649 / JHM 522610	1309568	TRB
				JM 720249 / JM 720210	1105776	TRB
Diferencial - engrenagem central / Diferencial - engranaje central / Differential - central gear				32020 XF	1364630	TRB
				F 15048	345465	STRB
Diferencial - pinhão (ext.) / Diferencial - piñón (ext.) / Differential - pinion (outer)				31312 F	174716	TRB
				33212 F	345833	TRB
Diferencial - pinhão int. / Diferencial - piñón (int.) / Differential - inner pinion				F 15048	315465	STRB
Diferencial - ponta do pinhão / Diferencial - punta de piñón / Differential - pinion				F 19076	1331313	CRBS
				F 19001	1309569	CRBS
				N 2211 FMNR / C3	1331313	CRB
Roda / Rueda / Wheel				32207 F	202635	TRB
				32220 F	123630	TRB
				32308 BF	322747	TRB
				32308 BF	322747	TRB
				32316 F	123629	TRB
				33212 F	345833	TRB

	OUT	IN		Fersa®	Nº OEM	
---	-----	----	---	---------------	--------	---

SCANIA (SA)

P 114 * R 124 * T 114 CB (6x4*4x2) * T 124

Eixo Traseiro / Eje Trasero / Rear Axle

Roda / Rueda / Wheel				HM 218248 / HM 218210	291060	TRB
				HM 218248 / HM 218210	291060	TRB

Embreagem / Embrague / Clutch

Desengate / Desembrague / Clutch				6014 2RS / C4	1319737	BB
----------------------------------	--	--	--	---------------	---------	----

P 114 GA (4X2) * R 114 GA (4X2*6X4) * T 114 GA (4X2) * T 114 LA (6X2)

Caixa de Mudanças / Caja de Cambios / Gearbox

Eixo intermediário (dir.) / Eje intermedio (der.) / Intermediate shaft (right)				30312 F		TRB
Eixo primário / Eje primario / Primary shaft				30314 F		TRB
Eixo secundário (dianteiro) / Eje secundario (delantero) / Secondary shaft (front)			G 777	33208 F		TRB
Eixo secundário (dir.) / Eje secundario (der.) / Secondary shaft (right)				30314 F		TRB
			330/360/420 * GRS 900/GRS 900 R T 114 LA (6X2) 420	30314 F		TRB

Eixo Traseiro / Eje Trasero / Rear Axle

Diferencial - coroa lateral (dir.) / Diferencial - corona lateral (der.) / Differential - crown gear (right)			RP 831	30217 F		TRB
Diferencial - pinhão (traseiro) / Diferencial - piñón (trasero) / Differential - pinion (rear)			R 653	F 15046		STRB
Eixo de apoio - roda (ext.) / Rueda - eje de apoyo (ext.) / Support shaft - wheel (outer)			ASA 60	32309 F		TRB
Eixo de apoio - roda (int.) / Rueda - eje de apoyo (int.) / Support shaft - wheel (inner)			ASA 60	32312 F		TRB

Embreagem / Embrague / Clutch

Desengate / Desembrague / Clutch				6014 2RS		BB
----------------------------------	--	--	--	----------	--	----

Motor / Motor / Engine

Bomba d'água (dianteiro) / Bomba de agua (delantero) / Water pump (front)				6305 2RS / C3		BB
Bomba d'água (traseiro) / Bomba de agua (trasero) / Water pump (rear)				6205 2RS		BB
Bomba de óleo / Bomba de aceite / Oil pump				6304 C4		BB
Polia tensora - rodam. / Polea tensora - rodam. / Tensioner pulley - bearing				6205 2RS		BB
Ventilador (dianteiro/traseiro) / Ventilador (delantero/ trasero) / Fan (front/rear)				6305		BB
Virabrequim - ponta / Cigüeñal - punta / Crankshaft spindle				6305 2RS		BB

P 124 CA (6X4) * P 124 GA*GB (4X2) * R 124 LA (4X2) * T 124 GA (4X2 * 6X4) * T 124 LA (4X2)

Caixa de Mudanças / Caja de Cambios / Gearbox

Eixo intermediário (dir.) / Eje intermedio (der.) / Intermediate shaft (right)				30312 F		TRB
Eixo primário / Eje primario / Primary shaft				30314 F		TRB
Eixo secundário (dir.) / Eje secundario (der.) / Secondary shaft (right)				30314 F		TRB

P 94 CB (6X4*6x2*4x2)

Caixa de Mudanças / Caja de Cambios / Gearbox

Caixa auxiliar - eixo entrada (dianteiro) / Caja auxiliar - eje entrada (delantero) / Auxiliar box - input shaft (front)			G 660	6411 NR / C3		BB
---	--	--	-------	--------------	--	----

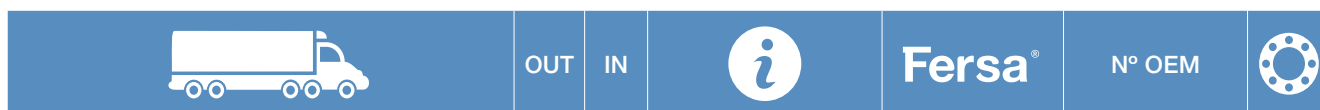

SCANIA (SA)

P 94 CB (6X4*6x2*4x2)

Caixa de Mudanças / Caja de Cambios / Gearbox

Caixa auxiliar - eixo intermediário (dianteiro) / Caja auxiliar - eje intermedio (delantero) / Auxiliar box - intermediate shaft (front)			G 660	6409 NR / C3		BB
Caixa auxiliar - eixo saída (traseiro) / Caja auxiliar - eje salida (trasero) / Auxiliar box - output shaft (rear)			G 660	6311 NR / C3		BB
Eixo intermediário (dianteiro) / Eje intermedio (delantero) / Intermediate shaft (front)			G 655/G 505	6407 C3		BB
			G 660/670/671/672	6409 C3		BB
Eixo intermediário (dir.) / Eje intermedio (der.) / Intermediate shaft (right)			310 - GR 801 K 94 IB (4X2) NB * GR 801 P 94 CB (6X4) 260 * P 94 DB (6X2), P 94 GA/GB (4X2) 260 * P 94 DB (4X2) 220/260	30312 F		TRB
Eixo intermediário (traseiro) / Eje intermedio (trasero) / Intermediate shaft (rear)			G 655/G 505	6309 NR / C3		BB
			G 660/670/671/672	6409 NR / C3		BB
Eixo primário / Eje primario / Primary shaft			310 - GR 801 K 94 IB (4X2) NB * GR 801 P 94 CB (6X4) 260 * P 94 DB (6X2), P 94 GA/ GB (4X2) 260 * P 94 DB (4X2) 220/260	30314 F		TRB
			G 655/G 505	6311 NR / C3		BB
			G 660/670/671/672	6411 NR / C3		BB
Eixo principal / Eje principal / Main shaft				6312 C3	1304315	BB
Eixo secundário (dir.) / Eje secundario (der.) / Secondary shaft (right)			310 - GR 801 K 94 IB (4X2) NB * GR 801 P 94 CB (6X4) 260 * P 94 DB (6X2), P 94 GA/ GB (4X2) 260 * P 94 DB (4X2) 220/260	30314 F		TRB
Eixo secundário (traseiro) / Eje secundario (trasero) / Secondary shaft (rear)			G 655/G 505	6311 NR / C3		BB
			G 660/670/671/672	6411 NR / C3		BB
Planetária / Planetario / Planetary				6312 C3	1304315	BB
Planetário - eixo de saída (dianteiro) / Planetario - eje de salida (delantero) / Planetary - output shaft (front)			G 670/671/672	6015 Z		BB
Planetário - eixo de saída (traseiro) / Planetario - eje de salida (trasero) / Planetary - output shaft (rear)			G 670/671/672	6311		BB

Cardan / Cardan / Cardan

Apoio / Apoyo / Support			G 655/ G 505	6211		BB
-------------------------	--	--	--------------	------	--	----

Eixo Dianteiro / Eje Delantero / Front Axle

Roda / Rueda / Wheel				32308 BF	1382900	TRB
	•			32308 F	14698	TRB
	•			32309 F	14836	TRB
		•		32311 F	179427	TRB
		•		32312 F	14623	TRB
Pino manga de eixo / Perno maestro de eje / King pin shaft				31309 F		TRB

Eixo Traseiro / Eje Trasero / Rear Axle

Diferencial - caixa satélite lat. (dir.) / Diferencial - caja satélite - lat. (der.) / Differential - satellit box (right)				32313 BF		TRB
Diferencial - coroa (dir.) / Diferencial - corona (der.) / Differential - crown (right)				33017 F	1364631	TRB
				33018 F	1309570	TRB



SCANIA (SA)

P 94 CB (6X4 * 6x2 * 4x2)

Eixo Traseiro / Eje Trasero / Rear Axle

Diferencial - coroa (esq.) / Diferencial - corona (izq.) / Differential - crown (left)				JHM 522649 / JHM 522610	1309568	TRB
				JM 720249 / JM 720210	1105776	TRB
Diferencial - coroa lateral (dir./esq.) / Diferencial - corona lateral (der./izq.) / Differential - crown gear (right/left)				30217 F		TRB
Diferencial - eixo reduzida (dir./esq.) / Diferencial - eje reducción (der./izq.) / Differential - reduction shaft (right/left)				30217 F		TRB
Diferencial - engrenagem central / Diferencial - engranaje central / Differential - central gear				32020 XF	1364630	TRB
				F 15048	345465	STRB
Diferencial - pinhão (ext.) / Diferencial - piñón (ext.) / Differential - pinion (outer)				31312 F	174716	TRB
				33212 F	345833	TRB
Diferencial - pinhão int. / Diferencial - piñón (int.) / Differential - inner pinion				F 15048	315465	STRB
Diferencial - pinhão (dianteiro) / Diferencial - piñón (delantero) / Differential - pinion (front)				31312 F		TRB
Diferencial - pinhão (dianteiro/traseiro) / Diferencial - piñón (delantero/trasero) / Differential - pinion (front/rear)				31312 F		TRB
Diferencial - pinhão (traseiro) / Diferencial - piñón (trasero) / Differential - pinion (rear)				31314 F		TRB
Diferencial - ponta do pinhão / Diferencial - punta de piñón / Differential - pinion				F 19076	1331313	CRBS
				F 19001	1309569	CRBS
				N 2211 FMNR / C3	1331313	CRB
Roda / Rueda / Wheel				32207 F	202635	TRB
				32220 F	123630	TRB
				32308 BF	322747	TRB
				32316 F	123629	TRB
				33212 F	345833	TRB
				HM 218248 / HM 218210	291060	TRB

Embreagem / Embrague / Clutch

Alavanca de acionamento / Palanca de accionamiento / Drive lever				6201 ZZ		BB
Apoio / Apoyo / Support				6305 2RS		BB
Desengate / Desembrague / Clutch				6014 2RS / C4	1319737	BB

Motor / Motor / Engine

Alternador (dianteiro) / Alternador (delantero) / Alternator (front)				6202 2RS / C3		BB
Alternador (traseiro) / Alternador (trasero) / Alternator (rear)				6201 2RS / C3		BB
Bomba d'água (dianteiro) / Bomba de agua (delantero) / Water pump (front)			L * LS * B 75	6204		BB
			L * LS * B 75	6305		BB
Bomba d'água (traseiro) / Bomba de agua (trasero) / Water pump (rear)				6205		BB

	OUT	IN		Fersa®	N° OEM	
---	-----	----	---	---------------	--------	---

SCANIA (SA)

P 94 CB (6X4*6x2*4x2)

Motor / Motor / Engine

Bomba de óleo / Bomba de aceite / Oil pump				6304 C4		BB
Bomba injetora (dianteiro) / Bomba inyectora (delantero) / Injection pump (front)				6207 C3		BB
Bomba injetora (traseiro) / Bomba inyectora (traseiro) / Injection pump (rear)				6207 NR		BB
Compressor (dianteiro) / Compresor (delantero) / Compressor (front)				6207 C3		BB
Compressor (traseiro) / Compresor (traseiro) / Compressor (rear)				6011 C3		BB
Polia tensora - rolam. / Polea tensora - rodam. / Tensioner pulley - bearing			B 75/76	6205 RS		BB

Tomada de Força / Toma de Fuerza / Power Take-off

Eixo de saída (dianteiro) / Eje de salida (delantero) / Output shaft (front)			G 660	6207 C3		BB
Eixo intermediário (traseiro) / Eje intermedio (traseiro) / Intermediate shaft (rear)			G 660	6208		BB

P 94 GA * GB (4X2)

Caixa de Mudanças / Caja de Cambios / Gearbox

Caixa auxiliar - eixo entrada (dianteiro) / Caja auxiliar - eje entrada (delantero) / Auxiliar box - input shaft (front)			G 660	6411 NR / C3		BB
Caixa auxiliar - eixo intermediário (dianteiro) / Caja auxiliar - eje intermedio (delantero) / Auxiliar box - intermediate shaft (front)			G 660	6409 NR / C3		BB
Caixa auxiliar - eixo saída (traseiro) / Caja auxiliar - eje salida (traseiro) / Auxiliar box - output shaft (rear)			G 660	6311 NR / C3		BB
Eixo intermediário (dianteiro) / Eje intermedio (delantero) / Intermediate shaft (front)			G 655/G 505	6407 C3		BB
			G 660/670/671/672	6409 C3		BB
Eixo intermediário (dir.) / Eje intermedio (der.) / Intermediate shaft (right)			310 - GR 801 K 94 IB (4X2) NB * GR 801 P 94 CB (6X4) 260 * P 94 DB (6X2), P 94 GA/ GB (4X2) 260 * P 94 DB (4X2) 220/260	30312 F		TRB
Eixo intermediário (traseiro) / Eje intermedio (traseiro) / Intermediate shaft (rear)			G 655/G 505	6309 NR / C3		BB
			G 660/670/671/672	6409 NR / C3		BB
Eixo primário / Eje primario / Primary shaft			310 - GR 801 K 94 IB (4X2) NB * GR 801 P 94 CB (6X4) 260 * P 94 DB (6X2), P 94 GA/ GB (4X2) 260 * P 94 DB (4X2) 220/260	30314 F		TRB
			G 655/G 505	6311 NR / C3		BB
			G 660/670/671/672	6411 NR / C3		BB
Eixo secundário (dir.) / Eje secundario (der.) / Secondary shaft (right)			310 - GR 801 K 94 IB (4X2) NB * GR 801 P 94 CB (6X4) 260 * P 94 DB (6X2), P 94 GA/ GB (4X2) 260 * P 94 DB (4X2) 220/260	30314 F		TRB
Eixo secundário (traseiro) / Eje secundario (traseiro) / Secondary shaft (rear)			G 655/G 505	6311 NR / C3		BB
Eixo secundário (traseiro) / Eje secundario (traseiro) / Secondary shaft (rear)			G 660/670/671/672	6411 NR / C3		BB
Planetário - eixo de saída (dianteiro) / Planetario - eje de salida (delantero) / Planetary - output shaft (front)			G 670/671/672	6015 Z		BB
Planetário - eixo de saída (traseiro) / Planetario - eje de salida (traseiro) / Planetary - output shaft (rear)			G 670/671/672	6311		BB

Cardan / Cardan / Cardan

Apoio / Apoyo / Support			G 655/ G 505	6211		BB
-------------------------	--	--	--------------	-------------	--	----

	OUT	IN		Fersa®	Nº OEM	
---	-----	----	---	---------------	--------	---

SCANIA (SA)

P 94 GA * GB (4X2)

Eixo Dianteiro / Eje Delantero / Front Axle

Pino manga de eixo / Perno maestro de eje / King pin shaft				31309 F		TRB
--	--	--	--	----------------	--	-----

Eixo Traseiro / Eje Trasero / Rear Axle

Diferencial - caixa satélite lat. (dir.) / Diferencial - caja satélite - lat. (der.) / Differential - satellit box (right)				32313 BF		TRB
Diferencial - coroa lateral (dir./esq.) / Diferencial - corona lateral (der./izq.) / Differential - crown gear (right/left)				30217 F		TRB
Diferencial - eixo reduzida (dir./esq.) / Diferencial - eje reducción (der./izq.) / Differential - reduction shaft (right/left)				30217 F		TRB
Diferencial - pinhão (dianteiro) / Diferencial - piñón (delantero) / Differential - pinion (front)				31312 F		TRB
Diferencial - pinhão (dianteiro/traseiro) / Diferencial - piñón (delantero/trasero) / Differential - pinion (front/rear)				31312 F		TRB
Diferencial - pinhão (traseiro) / Diferencial - piñón (trasero) / Differential - pinion (rear)				31314 F		TRB

Embreagem / Embrague / Clutch

Alavanca de acionamento / Palanca de accionamiento / Drive lever				6201 ZZ		BB
Apoio / Apoyo / Support				6305 2RS		BB

Motor / Motor / Engine

Alternador (dianteiro) / Alternador (delantero) / Alternator (front)				6202 2RS / C3		BB
Alternador (traseiro) / Alternador (trasero) / Alternator (rear)				6201 2RS / C3		BB
Bomba d'água (dianteiro) / Bomba de agua (delantero) / Water pump (front)		L * LS * B 75		6204		BB
		L * LS * B 75		6305		BB
Bomba d'água (traseiro) / Bomba de agua (trasero) / Water pump (rear)				6205		BB
Bomba de óleo / Bomba de aceite / Oil pump				6304 C4		BB
Bomba injetora (dianteiro) / Bomba inyectora (delantero) / Injection pump (front)				6207 C3		BB
Bomba injetora (traseiro) / Bomba inyectora (trasero) / Injection pump (rear)				6207 NR		BB
Compressor (dianteiro) / Compresor (delantero) / Compressor (front)				6207 C3		BB
Compressor (traseiro) / Compresor (trasero) / Compressor (rear)				6011 C3		BB
Polia tensora - rodam. / Polea tensora - rodam. / Tensioner pulley - bearing		B 75/76		6205 RS		BB

Tomada de Força / Toma de Fuerza / Power Take-off

Eixo de saída (dianteiro) / Eje de salida (delantero) / Output shaft (front)		G 660		6207 C3		BB
Eixo intermediário (traseiro) / Eje intermedio (trasero) / Intermediate shaft (rear)		G 660		6208		BB

R 112 (81...)

Caixa de Mudanças / Caja de Cambios / Gearbox

Eixo intermediário (traseiro) / Eje intermedio (trasero) / Intermediate shaft (rear)		GR 870		482 / 472		TRB
Eixo secundário (dianteiro) / Eje secundario (delantero) / Secondary shaft (front)		GR 870/G 770		33208 F	284843	TRB
Planetário - eixo secundário (dianteiro) / Planetario - eje secundario (delantero) / Planetary - secondary shaft (front)		G 770		6015 Z		BB

	OUT	IN		Fersa®	N° OEM	
---	-----	----	---	---------------	--------	---

SCANIA (SA)

R 112 (81...)

Caixa de Mudanças / Caja de Cambios / Gearbox

Planetário - eixo secundário (traseiro) / Planetario - eje secundario (traseiro) / Planetary - secondary shaft (rear)			G 770	6311		BB
			GR 870	6215 NR / C3		BB

Cardan / Cardan / Cardan

Suporte / Soporte / Support			EGR 870	6211	14093	BB
-----------------------------	--	--	---------	------	-------	----

Eixo Dianteiro / Eje Delantero / Front Axle

Roda / Rueda / Wheel	•			32308 F	14698	TRB
	•			32309 F	14623	TRB
		•		32311 F	179427	TRB
		•		32312 F	14836	TRB

Eixo Traseiro / Eje Trasero / Rear Axle

Diferencial - acionamento da engrenagem (dianteiro) / Diferencial - accionamiento de engranajes (delantero) / Differential - gear drive (front)			RBP 830	32020 XF		TRB
Diferencial - acionamento da engrenagem (traseiro) / Diferencial - accionamiento de engranajes (traseiro) / Differential - gear drive (rear)			RBP 830	JM 716649 / JM 716610		TRB
Diferencial - coroa lateral (dir./esq.) / Diferencial - corona lateral (der./izq.) / Differential - crown gear (right/left)			RBP 830/RP 830	30217 F	174717	TRB
Diferencial - coroa lateral (dir.) / Diferencial - corona lateral (der.) / Differential - crown gear (right)			R 752	33017 F		TRB
Diferencial - coroa lateral (esq.) / Diferencial - corona lateral (izq.) / Differential - crown gear (left)			R 752	32022 XF		TRB
Diferencial - eixo de entrada / saída / Diferencial - eje de (entrada / salida) / Differential - input / output shaft			RBP 830	JLM 508748 / JLM 508710		TRB
Diferencial - pinhão (dianteiro) / Diferencial - piñón (delantero) / Differential - pinion (front)			RBP 830	31312 F	174716	TRB
			RP 830	H 913842 / H 913810		TRB
			R 752	F 15046		STRB
				F 15046	194050	STRB
Diferencial - pinhão (traseiro) / Diferencial - piñón (traseiro) / Differential - pinion (rear)			RBP 830 * RP 830	32315 BF		TRB
				32315 BF	194137	TRB
				F 15046	194050	STRB
Roda / Rueda / Wheel				32020 XF	274114	TRB
				32218 F	14835	TRB
				HM 218248 / HM 218210	291060/ 1524625	TRB

Embreagem / Embrague / Clutch

Apoio / Apoyo / Support				6305 2RS		BB
				6305 2RS	168248	BB
Desengate / Desembrague / Clutch				6212	14831	BB
				6014 2RS	215139	BB

Motor / Motor / Engine

Alternador (dianteiro) / Alternador (delantero) / Alternator (front)				62201 2RS / C3		BB
				6303 2RS / C3	220137	BB
				6303 2RS / C3		BB
Alternador (traseiro) / Alternador (traseiro) / Alternator (rear)				62201 2RS / C3		BB
Bomba d'água (dianteiro) / Bomba de agua (delantero) / Water pump (front)				6205 2RS / C3	2288365	BB

	OUT	IN		Fersa®	Nº OEM	
---	-----	----	---	---------------	--------	---

SCANIA (SA)

R 112 (81...)

Motor / Motor / Engine

Bomba d'água (traseiro) / Bomba de agua (traseiro) / Water pump (rear)				6205 2RS		BB
				6305 2RS / C3	258267	BB
Bomba de óleo / Bomba de aceite / Oil pump				6304	240288/152897	BB
Bomba direção / Bomba de dirección / Direction pump				6004	144280	BB
Bomba injetora (dianteiro) / Bomba inyectora (delantero) / Injection pump (front)				6207 C3	14091	BB
Bomba injetora (traseiro) / Bomba inyectora (traseiro) / Injection pump (rear)				6007	140180	BB
Compressor de ar (dianteiro) / Compresor de aire (delantero) / Air compressor (front)				6207 C3	14091	BB
Compressor de ar (traseiro) / Compresor de aire (traseiro) / Air compressor (rear)				6011 C3	141930	BB
Polia tensora / Polea tensora / Tensioner pulley				6205 2RS	228836	BB
Ventilador / Ventilador / Fan				6305 2RS	168248	BB
Virabrequim - ponta / Cigüeñal - punta / Crankshaft spindle				6305 2RS	168248	BB

Tomada de Força / Toma de Fuerza / Power Take-off

Eixo de saída (dianteiro) / Eje de salida (delantero) / Output shaft (front)			EGR 870	32306 F	14614	TRB
Eixo de saída (traseiro) / Eje de salida (traseiro) / Output shaft (rear)			EGR 870	32208 F	214104	TRB
Eixo de saída (dianteiro/traseiro) / Eje de salida (delantero/traseiro) / Output shaft (front/rear)			EGR 870 * EG 750	32306 F		TRB

R 142 MA (4X2) (81...)

Caixa de Mudanças / Caja de Cambios / Gearbox

Eixo intermediário (traseiro) / Eje intermedio (traseiro) / Intermediate shaft (rear)			GR 870	482 / 472		TRB
Eixo secundário (dianteiro) / Eje secundario (delantero) / Secondary shaft (front)			GR 870	33208 F	284843	TRB
Planetário - eixo de saída (traseiro) / Planetario - eje de salida (traseiro) / Planetary - output shaft (rear)			GR 870	6215 NR / C3		BB

Cardan / Cardan / Cardan

Suporte / Soporte / Support				6211	14093	BB
				6212	14381	BB
			EGR 870	6212		BB

Direção / Dirección / Steering

Bomba servo direção / Bomba servo dirección / Steering servopump				6304		BB
--	--	--	--	-------------	--	----

Eixo Dianteiro / Eje Delantero / Front Axle

Roda / Rueda / Wheel	•			32308 F	14698	TRB
	•			32309 F	14623	TRB
		•		32311 F	179427	TRB
		•		32312 F	14836	TRB

Eixo Traseiro / Eje Trasero / Rear Axle

Diferencial - coroa lateral (dir./esq.) / Diferencial - corona lateral (der./izq.) / Differential - crown gear (right/left)				30217 F	174717	TRB
Diferencial - coroa lateral (dir.) / Diferencial - corona lateral (der.) / Differential - crown gear (right)			R 752	33017 F		TRB
Diferencial - coroa lateral (esq.) / Diferencial - coroa lateral (izq.) / Differential - crown gear (left)			R 752	32022 XF		TRB

	OUT	IN		Fersa®	N° OEM	
---	-----	----	---	---------------	--------	---

SCANIA (SA)

R 142 MA (4X2)(81...)

Eixo Traseiro / Eje Trasero / Rear Axle

Diferencial - pinhão (dianteiro) / Diferencial - piñón (delantero) / Differential - pinion (front)				31312 F	174716	TRB
				32315 BF	194137	TRB
			R 752	F 15046		STRB
				F 15046	194050	STRB
Roda / Rueda / Wheel				32020 XF	274114	TRB
				32218 F	14835	TRB
				32219 F	33948	TRB

Embreagem / Embrague / Clutch

Apoio / Apoyo / Support				6305 2RS	168248	BB
Desengate / Desembrague / Clutch				6212	14831	BB

Motor / Motor / Engine

Alternador (dianteiro) / Alternador (delantero) / Alternator (front)				6202 Z / C3		BB
				6303 2RS / C3	220137	BB
Alternador (traseiro) / Alternador (trasero) / Alternator (rear)				6201 Z / C3		BB
Alternador (traseiro) / Alternador (trasero) / Alternator (rear)				62201 2RS / C3		BB
Bomba d'água / Bomba de agua / Water pump				6205 2RS / C3	14090	BB
Bomba injetora (traseiro) / Bomba inyectora (trasero) / Injection pump (rear)				6205 C3	170727	BB
				6305 C3	170793	BB
Compressor de ar (dianteiro) / Compresor de aire (delantero) / Air compressor (front)				6207 C3	14091	BB
Compressor de ar (traseiro) / Compresor de aire (trasero) / Air compressor (rear)				6011 C3	141930	BB
Direção / Dirección / Direction				6304	14125	BB
Direção - pinhão / Dirección - piñón / Direction - pinion				6007 C3	174668	BB
Ventilador (dianteiro) / Ventilador (delantero) / Fan (front)				6207 C3	14091	BB
Ventilador (traseiro) / Ventilador (trasero) / Fan (rear)				6307	14610	BB

Tomada de Força / Toma de Fuerza / Power Take-off

Eixo de saída (dianteiro) / Eje de salida (delantero) / Output shaft (front)				32306 F	14614	TRB
Eixo de saída (traseiro) / Eje de salida (trasero) / Output shaft (rear)				32208 F	214104	TRB
Eixo de saída (dianteiro) / Eje de salida (delantero) / Output shaft (front)			EGR 870	32306 F		TRB
Eixo de saída (traseiro) / Eje de salida (trasero) / Output shaft (rear)			EGR 870	32208 F		TRB

Série 4 (4X2)

Caixa de Mudanças / Caja de Cambios / Gearbox

Eixo intermediário (dir.) / Eje intermedio (der.) / Intermediate shaft (right)			GR 801	30312 F		TRB
Eixo primário / Eje primario / Primary shaft			GR 801	30314 F		TRB
Eixo secundário (dir.) / Eje secundario (der.) / Secondary shaft (right)			GR 801	30314 F		TRB

Eixo Dianteiro / Eje Delantero / Front Axle

Pino manga (inf.) / Perno maestro de eje (inf.) / King pin shaft (lower)				32308 F		TRB
Roda / Rueda / Wheel				F 15097		HWT

Eixo Traseiro / Eje Trasero / Rear Axle

Diferencial - lateral coroa esq. / Diferencial - lateral corona (izq.) / Differential - crown gear (left)				33017 F		TRB
Diferencial - pinhão (traseiro) / Diferencial - piñón (trasero) / Differential - pinion (rear)				31312 F		TRB

	OUT	IN		Fersa ®	Nº OEM	
---	-----	----	---	----------------	--------	---

SCANIA (SA)

T 142 E (6X4)

Caixa de Mudanças / Caja de Cambios / Gearbox

Eixo intermediário (traseiro) / Eje intermedio (trasero) / Intermediate shaft (rear)			GR 870	482 / 472		TRB
Eixo secundário (dianteiro) / Eje secundario (delantero) / Secondary shaft (front)			GR 870	33208 F		TRB
Planetário - eixo de saída (traseiro) / Planetario - eje de salida (trasero) / Planetary - output shaft (rear)			GR 870	6215 C3		BB

Cardan / Cardan / Cardan

Suporte / Soporte / Support				6211	14093	BB
			EGR 870	6212	14381	BB

Direção / Dirección / Steering

Bomba servo direção / Bomba servo dirección / Steering servopump				6304		BB
--	--	--	--	------	--	----

Eixo Dianteiro / Eje Delantero / Front Axle

Roda / Rueda / Wheel	•			32308 F	14698	TRB
	•			32309 F	14623	TRB
		•		32311 F	179427	TRB
		•		32312 F	14836	TRB

Eixo Traseiro / Eje Trasero / Rear Axle

Diferencial - acionamento da engrenagem dianteiro / Diferencial - accionamiento de engranajes (delantero) / Differential - gear drive (front)			RBP 830	32020 XF		TRB
Diferencial - acionamento da engrenagem traseiro / Diferencial - accionamiento de engranajes (trasero) / Differential - gear drive (rear)			RBP 830	JM 716649 / JM 716610		TRB
Diferencial - coroa lateral (dir./esq.) / Diferencial - corona lateral (der./izq.) / Differential - crown gear (right/left)			RBP 830/RP 830	30217 F	174717	TRB
Diferencial - eixo de entrada / Diferencial - eje de entrada / Differential - input shaft			RBP 830/RP 830	JLM 508748 / JLM 508710		TRB
Diferencial - pinhão (dianteiro) / Diferencial - piñón (delantero) / Differential - pinion (front)			RBP 830	31312 F	174716	TRB
				32315 BF	194137	TRB
			RP 830	H 913842 / H 913810		TRB
			F 15046	194050	STRB	
Diferencial - pinhão (traseiro) / Diferencial - piñón (trasero) / Differential - pinion (rear)			RBP 830/RP 830	32315 BF		TRB
Roda / Rueda / Wheel				32020 XF	274114	TRB
				32218 F	14835	TRB
				32219 F	33948	TRB

Embreagem / Embrague / Clutch

Apoio / Apoyo / Support				6305 2RS		BB
				6305 2RS	168248	BB
Desengate / Desembrague / Clutch				6212	14831	BB

Motor / Motor / Engine

Alternador (dianteiro) / Alternador (delantero) / Alternator (front)				6202 Z / C3		BB
				6303 2RS / C3	220137	BB
Alternador (traseiro) / Alternador (trasero) / Alternator (rear)				6201 Z / C3		BB
Bomba d'água / Bomba de agua / Water pump				6205 2RS / C3	14090	BB
Bomba injetora (traseiro) / Bomba inyectora (trasero) / Injection pump (rear)				6205 C3	170727	BB
				6305 C3	170793	BB



STERLING

AT 9500

Eixo Dianteiro / Eje Delantero / Front Axle

Roda / Rueda / Wheel	●		FF-931, 12,000 lb.	3782 / 3720	807949	TRB
		●	FF-931, 12,000 lb.	HM 212047 / HM 212011	C4TA1215B	TRB
		●	FG-961, 13,200 lb.	HM 212049 / HM 212011		TRB

Eixo Traseiro / Eje Trasero / Rear Axle

Roda / Rueda / Wheel	●		31,000, 35,000 lb.	580 / 572	0039811405 /	TRB
		●	31,000, 35,000 lb.	594 A / 592 A	0039811405 / 183704	TRB

L7500

Eixo Traseiro / Eje Trasero / Rear Axle

Diferencial (dir.) / Diferencial (der.) / Differential (right)			35,000 lb.	64450 / 64700		TRB
Diferencial - (esq.) / Diferencial - (izq.) / Differential (left)			35,000 lb.	JHM 720249 / JHM 720210		TRB
Diferencial - pinhão cabeça / Diferencial - piñón cabeza / Differential - pinion head			35,000 lb.	9278 / 9220		TRB
Roda / Rueda / Wheel	●		31,000, 35,000 lb.	580 / 572	0039811405 /	TRB
		●	31,000, 35,000 lb.	594 A / 592 A	0039811405 / 183704	TRB

Eixo Dianteiro / Eje Delantero / Front Axle

Roda / Rueda / Wheel	●		FF-931, 12,000, 13,200 lb.	3782 / 3720	807949	TRB
		●	FF-931, 12,000, 13,200 lb.	HM 212047 / HM 212011	C4TA1215B	TRB
		●	FG-961, 14,600 lb.	3782 / 3720	807949	TRB
		●	FG-961, 14,600 lb.	HM 212049 / HM 212011		TRB

LT7500

Eixo Dianteiro / Eje Delantero / Front Axle

Roda / Rueda / Wheel	●		FC941, FC965 7,000 / 9,000	3782 / 3720	807949	TRB
		●	FC941, FC965 7,000 / 9,000	JM 207049 A / JM 207011		TRB
		●	FF-931, 12,000, 13,200 lb.	3782 / 3720	807949	TRB
		●	FF-931, 12,000, 13,200 lb.	HM 212047 / HM 212011	C4TA1215B	TRB
		●	FG-961, 14,600 lb.	3782 / 3720	807949	TRB
		●	FG-961, 14,600 lb.	HM 212049 / HM 212011		TRB
		●	FL-941, 20,000 lb.	555 S / 552 A		TRB
		●	FL-941, 20,000 lb.	6461A / 6420		TRB



Eixo Traseiro / Eje Trasero / Rear Axle

Roda / Rueda / Wheel	●		52,000 lb.	580 / 572	0039811405 /	TRB
		●	52,000 lb.	594 A / 592 A	0039811405 / 183704	TRB

LT9500

Eixo Dianteiro / Eje Delantero / Front Axle

Roda / Rueda / Wheel	●		FF-931, 12,000, 13,200 lb.	3782 / 3720	807949	TRB
		●	FF-931, 12,000, 13,200 lb.	HM 212047 / HM 212011	C4TA1215B	TRB
		●	FG-961, 14,600 lb.	3782 / 3720	807949	TRB

	OUT	IN		Fersa®	Nº OEM	
---	-----	----	---	---------------	--------	---

VOLKSWAGEN

11-130 * 11-140 * 11-160

Eixo Traseiro / Eje Trasero / Rear Axle

Diferencial - coroa lateral (esq.) / Diferencial - coroa lateral (izq.) / Differential - crown gear (left)				42381 / 42584		TRB
Diferencial - pinhão (dianteiro) / Diferencial - piñón (delantero) / Differential - pinion (front)			11-140 * 12-140	M 802048 / M 802011		TRB
Diferencial - pinhão (traseiro) / Diferencial - piñón (trasero) / Differential - pinion (rear)				HM 807046 / HM 807010		TRB

Eixo Dianteiro / Eje Delantero / Front Axle

Roda / Rueda / Wheel	•			3585 / 3525	T13407637 / T13407628	TRB
		•		39581 / 39520	T13407632 / 119305	TRB

Eixo Traseiro / Eje Trasero / Rear Axle

Roda / Rueda / Wheel		•		33287 / 33462	TE3501285 / TE3501287	TRB
----------------------	--	---	--	---------------	-----------------------	-----

Motor / Motor / Engine

Alternador (dianteiro) / Alternador (delantero) / Alternator (front)			Bosch - MWM 229-6	6303 2RS / C3		BB
Alternador (traseiro) / Alternador (trasero) / Alternator (rear)			Bosch - MWM 229-6	6201 2RS / C3		BB
Bomba injetora (dianteiro) / Bomba inyectora (delantero) / Injection pump (front)			Bosch - MWM 11-130 * 13-130	6203		BB
			Bosch - MWM 12-140	30203 F		TRB
Bomba injetora (traseiro) / Bomba inyectora (trasero) / Injection pump (rear)			Bosch - MWM 12-140	30204 F		TRB

12-140 * 12-140 H * 12-140 T * 12-170 BT

Eixo Traseiro / Eje Trasero / Rear Axle

Diferencial - coroa lateral (esq.) / Diferencial - coroa lateral (izq.) / Differential - crown gear (left)				42381 / 42584		TRB
Diferencial - pinhão (dianteiro) / Diferencial - piñón (delantero) / Differential - pinion (front)			11-140 * 12-140	M 802048 / M 802011		TRB
Diferencial - pinhão (traseiro) / Diferencial - piñón (trasero) / Differential - pinion (rear)				HM 807046 / HM 807010		TRB
Diferencial / Diferencial / Differential				33281 / 33462	2986596	TRB

Eixo Dianteiro / Eje Delantero / Front Axle

Roda / Rueda / Wheel	•			3585 / 3525	T11/407628	TRB
		•		39581 / 39520	T11/501287	TRB

Eixo Traseiro / Eje Trasero / Rear Axle

Roda / Rueda / Wheel		•		33287 / 33462	TE3501285 / TE3501287	TRB
	•			39590 / 39520	T11/9360	TRB
		•		47686 / 47620	T12/501315	TRB

Motor / Motor / Engine

Alternador (dianteiro) / Alternador (delantero) / Alternator (front)			Bosch - MWM 229-6	6303 2RS / C3		BB
Alternador (traseiro) / Alternador (trasero) / Alternator (rear)			Bosch - MWM 229-6	6201 2RS / C3		BB
Bomba injetora (dianteiro) / Bomba inyectora (delantero) / Injection pump (front)			Bosch - MWM 11-130 * 13-130	6203		BB
			Bosch - MWM 12-140	30203 F		TRB
Bomba injetora (traseiro) / Bomba inyectora (trasero) / Injection pump (rear)			Bosch - MWM 12-140	30204 F		TRB

	OUT	IN		Fersa [®]	N° OEM	
---	-----	----	---	---------------------------	--------	---

VOLKSWAGEN

13-130 * 13-150 * 13-170 * 13-180E * 13-190 (77...)E * 13-210

Caixa de Mudanças / Caja de Cambios / Gearbox

Eixo intermediário (dir.) / Eje intermedio (der.) / Intermediate shaft (right)			13-150 MWM 4.10 TCA * 13-170 Cummins 6 BTAA * 13-180 MWM 6.10 TCA * Eaton FS 4205 (13 -150/13 - 170/13 -180)	25877 / 25821		TRB
Eixo primário / Eje primario / Primary shaft			13-150 MWM 4.10 TCA * 13-170 Cummins 6 BTAA * 13-180 MWM 6.10 TCA * Eaton FS 4205 (13 -150/13 - 170/13 -180)	M 802048 / M 802011		TRB
Eixo secundário / Eje secundario / Secondary shaft			13-150 MWM 4.10 TCA * 13-170 Cummins 6 BTAA * 13-180 MWM 6.10 TCA * Eaton FS 4205 (13 -150/13 - 170/13 -180)	25581 / 25520		TRB

Eixo Dianteiro / Eje Delantero / Front Axle

Roda / Rueda / Wheel	•			3585 / 3525	T13407637/ T13407628 /	TRB
	•			3585 / 3525	2RH498628	TRB
		•		39581 / 39520	T13407632/119305 /	TRB
		•		39581 / 39520	2S0498625A	TRB

Eixo Traseiro / Eje Trasero / Rear Axle

Roda / Rueda / Wheel	•			39590 / 39520	T11/9360 / 2RH598313A	TRB
		•		47686 / 47620	T12/501315	TRB
		•		580 / 572	2S0598287B	TRB

Motor / Motor / Engine

Alternador (dianteiro) / Alternador (delantero) / Alternator (front)				6303 2RS / C3	2994206	BB
Alternador (traseiro) / Alternador (trasero) / Alternator (rear)				6201 2RS / C3	2994207	BB
Polia tensora / Polea tensora / Tensioner pulley				6204 2RS C3	603200746204	BB

14-140 * 14-150 * 14-170 BT * 14-180 * 14-200 * 14-210 * 14-220

Eixo Traseiro / Eje Trasero / Rear Axle

Diferencial - coroa lateral (dir./esq.) / Diferencial - corona lateral (der./izq.) / Differential - crown gear (right/left)		•		594 / 592 A	T12/501315A / 2S0598287B	TRB
Diferencial - coroa lateral (esq.) / Diferencial - corona lateral (izq.) / Differential - crown gear (left)				JM 716649 / JM 716610		TRB
	•			580 / 572	2RH598313A	TRB

Eixo Dianteiro / Eje Delantero / Front Axle

Roda / Rueda / Wheel	•			3782 / 3720	TMJ407628 2S0498625A	TRB
		•		HM 212049 / HM 212011	2RH/498628	TRB

Motor / Motor / Engine

Alternador (dianteiro) / Alternador (delantero) / Alternator (front)				6303 2RS / C3	2994206	BB
Alternador (traseiro) / Alternador (trasero) / Alternator (rear)				6201 2RS / C3	2994207	BB
Bomba injetora (dianteiro) / Bomba inyectora (delantero) / Injection pump (front)				30203 F		TRB
Bomba injetora (traseiro) / Bomba inyectora (trasero) / Injection pump (rear)				30204 F		TRB



VOLKSWAGEN

15-170 * 15-170E * 15-180 * 15-180E * 15-180 OD * 15-190 (77...) * 15-190 (77...)EOD

Eixo Traseiro / Eje Trasero / Rear Axle

Diferencial / Diferencial / Differential				JM 716649 / JM 716610		TRB
--	--	--	--	-----------------------	--	-----

Eixo Dianteiro / Eje Delantero / Front Axle

Roda / Rueda / Wheel	•			3782 / 3720	TMJ407628 2S0498625A	TRB
		•		HM 212049 / HM 212011	2RH/498628	TRB

Eixo Traseiro / Eje Trasero / Rear Axle

Roda / Rueda / Wheel	•			580 / 572	2RH598313A	TRB
		•		594 A / 592 A	T12/501315A	TRB

Motor / Motor / Engine

Alternador (dianteiro) / Alternador (delantero) / Alternator (front)				6303 2RS / C3	2994206	BB
Alternador (traseiro) / Alternador (trasero) / Alternator (rear)				6201 2RS / C3	2994207	BB
Bomba injetora (dianteiro) / Bomba inyectora (delantero) / Injection pump (front)				30203 F		TRB
Bomba injetora (traseiro) / Bomba inyectora (trasero) / Injection pump (rear)				30204 F		TRB

16-170 * 16-180 * 16-200 * 16-210 * 16-220 CO * 16300

Eixo Traseiro / Eje Trasero / Rear Axle

Diferencial - coroa lateral (dir./esq.) / Diferencial - corona lateral (der./izq.) / Differential - crown gear (right/left)				JM 716649 / JM 716610		TRB
---	--	--	--	-----------------------	--	-----

Eixo Dianteiro / Eje Delantero / Front Axle

Roda / Rueda / Wheel	•			3782 / 3720	TMJ407628 2S0498625A	TRB
		•		HM 212049 / HM 212011	2RH/498628	TRB

Eixo Traseiro / Eje Trasero / Rear Axle

Roda / Rueda / Wheel	•			580 / 572	2RH598313A	TRB
		•		594 / 592 A	T12/501315A / 2S0598287B	TRB

Motor / Motor / Engine

Alternador (dianteiro) / Alternador (delantero) / Alternator (front)				6303 2RS / C3	2994206	BB
Alternador (traseiro) / Alternador (trasero) / Alternator (rear)				6201 2RS / C3	2994207	BB
Bomba injetora (dianteiro) / Bomba inyectora (delantero) / Injection pump (front)				30203 F		TRB
Bomba injetora (traseiro) / Bomba inyectora (trasero) / Injection pump (rear)				30204 F		TRB

18-310 TITAN * 18-310 OT

Eixo Dianteiro / Eje Delantero / Front Axle

Roda / Rueda / Wheel	•			3782 / 3720	2S0498625A	TRB
		•		HM 212049 / HM 212011	2RH/498628	TRB

Eixo Traseiro / Eje Trasero / Rear Axle

Roda / Rueda / Wheel	•			580 / 572	2RH598313A	TRB
		•		594 A / 592 A	2S0598287B	TRB

19-320 TITAN Tractor Constellation

Eixo Dianteiro / Eje Delantero / Front Axle

Roda / Rueda / Wheel	•			3782 / 3720	2S0498625A	TRB
		•		HM 212049 / HM 212011	2RH498628	TRB

	OUT	IN		Fersa®	N° OEM	
---	-----	----	---	---------------	--------	---

VOLKSWAGEN

19-320 TITAN Tractor Constellation

Eixo Traseiro / Eje Trasero / Rear Axle

Roda / Rueda / Wheel	•			580 / 572	2RH598313A	TRB
		•		594 A / 592 A	2S0598287B	TRB

24-220 * 24-250 * 24-250 Constellation * 24-250E * 26-220 * 26-260E * 26-300

Eixo Dianteiro / Eje Delantero / Front Axle

Roda / Rueda / Wheel	•			3782 / 3720	TMJ407628	TRB
		•		HM 212049 / HM 212011	2RH/498628	TRB

Eixo Traseiro / Eje Trasero / Rear Axle

Roda / Rueda / Wheel	•			580 / 572	2RH598313A	TRB
		•		594 A / 592 A	T12/501315A	TRB

31-260E * 35-300 * 40-300

Eixo Dianteiro / Eje Delantero / Front Axle

Roda / Rueda / Wheel	•			3782 / 3720	TMJ407628	TRB
		•		HM 212049 / HM 212011	2RH/498628	TRB

Eixo Traseiro / Eje Trasero / Rear Axle

Roda / Rueda / Wheel	•			580 / 572	2RH598313A	TRB
		•		594 A / 592 A	T12/501315A	TRB

5-140E Delivery * 5-140 EOD Volksbus

Eixo Dianteiro / Eje Delantero / Front Axle

Roda / Rueda / Wheel	•			15106 / 15250 X	2TA/498628A	TRB
		•		25590 / 25522	2TA/498628	TRB

Eixo Traseiro / Eje Trasero / Rear Axle

Roda / Rueda / Wheel	•			368 A / 362 A	2TA/598319	TRB
		•		3982 / 3920	2TA/598313	TRB

6-80 * 6-90 * 6-90 P*S

Caixa de Mudanças / Caja de Cambios / Gearbox

Eixo Intermediário (dianteiro/traseiro) / Eje Intermedio (delantero/trasero) / Intermediate shaft (front/rear)			8-120 MWM 4.10 NA * MWM 4.10 T (8-140, 8-140 CO/CE, 8-150) * 9-150 OD (MWM 4.10 TCA) * Eaton FSO 4305 A (8-120, 8-140, 8-140 CO/CE, 8-150, 9-150 OD)	25877 / 25821		TRB
Eixo primário / Eje primario / Primary shaft			8-120 MWM 4.10 NA * MWM 4.10 T (8-140, 8-140 CO/CE, 8-150) * 9-150 OD (MWM 4.10 TCA) * Eaton FSO 4305 A (8-120, 8-140, 8-140 CO/CE, 8-150, 9-150 OD)	M 802048 / M 802011		TRB
Eixo secundário / Eje secundario / Secondary shaft			8-120 MWM 4.10 NA * MWM 4.10 T (8-140, 8-140 CO/CE, 8-150) * 9-150 OD (MWM 4.10 TCA) * Eaton FSO 4305 A (8-120, 8-140, 8-140 CO/CE, 8-150, 9-150 OD)	25581 / 25520		TRB

Eixo Traseiro / Eje Trasero / Rear Axle

Diferencial - coroa lateral (dir./esq.) / Diferencial - corona lateral (der./izq.) / Differential - crown gear (right/left)			MWM 4.10 TCA * Dana 480 (8-120, 8-150, 9-150 OD)	387 A / 382 A		TRB
---	--	--	--	----------------------	--	-----

	OUT	IN		Fersa®	Nº OEM	
---	-----	----	---	---------------	--------	---

VOLKSWAGEN

6-80 * 6-90 * 6-90 P*S

Eixo Traseiro / Eje Trasero / Rear Axle

Diferencial - coroa lateral (dir./esq.) / Diferencial - coroa lateral (der./izq.) / Differential - crown gear (right) / (left)			6-80, 6-90, 6-90 (P,S) * 8-120 MWM 4.10 NA * 8-150 MWM 4.10 T * 9-150 OD	387 A / 382 A		TRB
Diferencial - pinhão (dianteiro) / Diferencial - piñón (delantero) / Differential - pinion (front)			MWM 4.10 T (8-140, 8-140 CO/CE, 8-150) * 8-120 MWM 4.10 NA * 9-150 OD MWM 4.10 TCA * Dana 480 (8-120, 8-140, 8-140 CO/ CE, 8-150, 9-150 OD)	HM 807046 / HM 807010		TRB
Diferencial - pinhão (traseiro) / Diferencial - piñón (trasero) / Differential - pinion (rear)				HM 807046 / HM 807010		TRB
			8-140, 8-140 CO/CE (MWM 4.10 T, Dana 480)	M 802048 / M 802011		TRB

Eixo Dianteiro / Eje Delantero / Front Axle

Roda / Rueda / Wheel	•			15106 / 15250 X	2986545	TRB
		•		25590 / 25522	2986544	TRB

Eixo Traseiro / Eje Trasero / Rear Axle

Roda / Rueda / Wheel	•			368 A / 362 A	0915862 / 0915863	TRB
		•		3982 / 3920	2986549	TRB

Motor / Motor / Engine

Polia tensora / Polea tensora / Tensioner pulley				6204 2RS C3	6,03201E+11	BB
--	--	--	--	--------------------	-------------	----

7-90 S * 7-100 * 7-110 S

Eixo Dianteiro / Eje Delantero / Front Axle

Roda / Rueda / Wheel	•			15106 / 15250 X	2TA/498628A	TRB
		•		25590 / 25522	2TA/498628	TRB

Eixo Traseiro / Eje Trasero / Rear Axle

Roda / Rueda / Wheel	•			368 A / 362 A	2TA/598319	TRB
		•		3982 / 3920	2TA/598313	TRB

D 1400 TD * Volksbus

Caixa de Mudanças / Caja de Cambios / Gearbox

Eixo intermed. (inf.) / Eje intermed. inf. / Intermediate shaft (lower)			Volksbus 93 * Eaton - FS 5106A	M 12649 / 610		TRB
Eixo intermed. (sup.) / Eje intermed. sup. / Intermediate shaft (upper)			Volksbus 93 * Eaton - FS 5106A	LM 48548 / 510		TRB
Eixo intermediário (dianteiro) / Eje intermedio (delantero) / Intermediate shaft (front)			Volksbus 93 * Eaton - FS 5106A	25590 / 25522		TRB
Eixo intermediário (traseiro) / Eje intermedio (trasero) / Intermediate shaft (rear)			Volksbus 93 * Eaton - FS 5106A	3782 / 3720		TRB
Eixo primário (dianteiro) / Eje primario (delantero) / Primary shaft (front)			Volksbus 93 * Eaton - FS 5106A	39590 / 39520		TRB

Eixo Traseiro / Eje Trasero / Rear Axle

Diferencial - coroa lateral (dir.) / Diferencial - coroa lateral (der.) / Differential - crown gear (right)			Volksbus 93 * Braseixos * Rockwell RS 240	JM 716649 / JM 716610		TRB
Diferencial - eixo reduzida (dir.) / Diferencial - eje reducción (der.) / Differential - reduction shaft (right)			E 13/E 21/D 1400 TD (Eixo L-345)	HM 807040 / HM 807010		TRB
Diferencial - eixo reduzida (esq.) / Diferencial - eje reducción (izq.) / Differential - reduction shaft (left)			E 13/E 21/D 1400 TD (Eixo L-345)	HM 807046 / HM 807010		TRB



VOLVO (NA & CA)

Autocar * VHD 64B 6X4

Eixo Dianteiro / Eje Delantero / Front Axle

Roda / Rueda / Wheel	•		Meritor FF-961, 12,000 lb.	3782 / 3720	807949	TRB
		•	Meritor FF-961, 12,000 lb.	HM 212049 / HM 212011	2RH/498628	TRB
	•		FL-941, FL-941 Dual, 20,000	555 S / 552 A		TRB
		•	FL-941, FL-941 Dual, 20,000	6461A / 6420		TRB

Eixo Traseiro / Eje Trasero / Rear Axle

Roda / Rueda / Wheel	•		40,00 lb.	580 / 572	003 981 14 05	TRB
		•	40,000 lb.	594 A / 592 A	183704	TRB

Autohailer 6X4

Eixo Dianteiro / Eje Delantero / Front Axle

Roda / Rueda / Wheel	•		13,200 lb.	3782 / 3720	807949	TRB
		•	13,200 lb.	HM 212049 / HM 212011	2RH/498628	TRB

Eixo Traseiro / Eje Trasero / Rear Axle

Roda / Rueda / Wheel	•		40,00 lb.	580 / 572	003 981 14 05	TRB
		•	40,000 lb.	594 A / 592 A	183704	TRB

B 10R * B 12B * B 12R * B 58 * B 58BR * B 7R * B9

Caixa de Mudanças / Caja de Cambios / Gearbox

				30306 F	001 981 71 05	TRB
--	--	--	--	---------	---------------	-----

Eixo Dianteiro / Eje Delantero / Front Axle

Roda / Rueda / Wheel				537 / 532 X		TRB
				6386 / 6320		TRB

Eixo Traseiro / Eje Trasero / Rear Axle

Diferencial / Diferencial / Differential				32213 F	11076	TRB
Roda / Rueda / Wheel	•			663 / 653	6889594	TRB

FH 12

Eixo Dianteiro / Eje Delantero / Front Axle

Roda / Rueda / Wheel				537 / 532 X		TRB
				6386 / 6320		TRB
	•	•		F 200001 A	20967831	KWT

Eixo Traseiro / Eje Trasero / Rear Axle

Diferencial - eixo (traseiro) / Diferencial - eje (trasero) / Differential - rear shaft				31312 F	181609	TRB
Roda / Rueda / Wheel				683 / 672	6889593	TRB
				HM 218248 / HM 218210	291060	TRB

NE 64 6X4 * NR 64 T

Eixo Dianteiro / Eje Delantero / Front Axle

Roda / Rueda / Wheel	•		12,000 lb.	3782 / 3720	807949	TRB
		•	12,000 lb.	HM 212047 / HM 212011	C4TA1215B	TRB
	•		20,000 lb.	3782 / 3720	807949	TRB
		•	20,000 lb.	HM 212049 / HM 212011	2RH/498628	TRB
	•		Meritor FG943	3782 / 3720	807949	TRB
		•	Meritor FG943	HM 212049 / HM 212011	2RH/498628	TRB
	•		FL941	555 S / 552 A		TRB
		•	FL941	6461A / 6420		TRB



VOLVO (SA)

FH 12 * FH 16

Caixa de Mudanças / Caja de Cambios / Gearbox

Eixo intermediário / Eje intermedio / Intermediate shaft				33212 F	1652563	TRB
				F 15047	0019801402	STRB
				F 19010		CRBS
				F 19039		CRBS
			SR 1700 * SR 190 (77...) ₀	33212 F		TRB
Eixo primário / Eje primario / Primary shaft			SR 1700 * SR 190 (77...) ₀	F 15116		STRB
Eixo secundário (interm.) / Eje secundario (interm.) / Secondary shaft (interm.)			R 1700	F 15116		STRB
Eixo secundário (traseiro) / Eje secundario (traseiro) / Secondary shaft (rear)			SR 1700 * SR 190 (77...) ₀	F 15116		STRB

Cardan / Cardan / Cardan

Suporte / Soporte / Support			NK 551 * NK2060 * NK 651	6014		BB
-----------------------------	--	--	-----------------------------	-------------	--	----

Direção / Dirección / Steering

Bomba servo (traseiro) / Bomba servo (traseiro) / Rear servopump				6304 2RS		BB
Bomba (traseiro) / Bomba (traseiro) / Pump (rear)				6304 2RS	181826	BB

Eixo Dianteiro / Eje Delantero / Front Axle

Roda / Rueda / Wheel	•	•		F 200001 A	20967831	KWT
	•	•		F 200003	20967830	KWT

Eixo Traseiro / Eje Trasero / Rear Axle

Diferencial - coroa lateral (dir./esq.) / Diferencial - coroa lateral (der./izq.) / Differential - crown gear (right/left)			EV-87 * EV-80	594 / 592		TRB
			EV-90 * EV-91	687 / 672		TRB
Diferencial - coroa lateral (dir.) / Diferencial - coroa lateral (der.) / Differential - crown gear (right)			EV-71 * EV-72	30217 F		TRB
Diferencial - coroa lateral (esq.) / Diferencial - coroa lateral (izq.) / Differential - crown gear (left)			EV-71 * EV-72	32017 XF		TRB
Diferencial - lateral coroa (dir./esq.) / Diferencial - lateral coroa (der./izq.) / Differential - crown gear (right/left)				687 / 672	181596 / 181279	TRB
Diferencial - lateral coroa (dir.) / Diferencial - lateral coroa (der.) / Differential - crown gear (right)				30217 F	184459	TRB
				594 / 592 A	181298	TRB
Diferencial - lateral coroa esq. / Diferencial - lateral coroa (izq.) / Differential - crown gear (left)				32017 XF	184623	TRB
Diferencial - lateral coroa esq. / Diferencial - lateral coroa (izq.) / Differential - crown gear (left)				594 / 592 A	183704	TRB
Diferencial - pinhão apoio / Diferencial - piñón apoyo / Differential - support pinion				NJ 2309 F / C3	1523243	CRB
Diferencial - pinhão inf. (dianteiro) / Diferencial - piñón inf. (delantero) / Differential - lower pinion (front)				HM 911245 / HM 911210	184633	TRB
Diferencial - pinhão inf. (traseiro) / Diferencial - piñón inf. (traseiro) / Differential - lower pinion (rear)			EV-72	31315 F		TRB
				31315 F	181396	TRB
Diferencial - pinhão sup. (dianteiro) / Diferencial - piñón sup. (delantero) / Differential - upper pinion (front)			EV-87 * EV72	30214 F		TRB
Diferencial - pinhão sup. (traseiro) / Diferencial - piñón sup. (traseiro) / Differential - upper pinion (rear)			EV-72	32015 XF		TRB
Diferencial - pinhão (dianteiro) / Diferencial - piñón (delantero) / Differential - pinion (front)				31312 F	181609	TRB
			EV-71	31312 F		TRB
Diferencial - pinhão (traseiro) / Diferencial - piñón (traseiro) / Differential - pinion (rear)			EV-90 * EV-91	F 15071		STRB
				H 913842 / H 913810	184635	TRB

	OUT	IN		Fersa®	N° OEM	
---	-----	----	---	---------------	--------	---

VOLVO (SA)

FH 12 * FH 16

Eixo Traseiro / Eje Trasero / Rear Axle

Roda / Rueda / Wheel	•			663 / 653	6889594	TRB
		•		683 / 672	181596/181279	TRB
				F 200002 A		

Embreagem / Embrague / Clutch

Fixação - eixo direcional (dianteiro) / Fijación eje direcional (delantero) / Directional shaft fixing (front)	•	•		6014		BB
				F 200002 A	21036050	KWT
Garfo de acionamento / Garfo de accionamiento / Drive fork			CL 38 D-O * CL 43 S-O	6006 2RS		BB

Motor / Motor / Engine

Accionamiento (dianteiro) / Accionamiento (delantero) / Drive (front)				6206 2RS	11013	BB
Accionamento - transmis.do eixo dianteiro / Accionamiento - transmis.de eje delantero / Drive - front axle transmission				6206		BB
Alternador (traseiro) / Alternador (trasero) / Alternator (rear)			28 V/80 A	62201 2RS / C3		BB
Ventilador / Ventilador / Fan				6014 C3	19278	BB
				6304 2RS	181826	BB
				6304 2RS		BB

N * NL 10 BR * N * NL 12 BR * N 10BR Mark II * NL 10BR 6x2

Caixa de Mudanças / Caja de Cambios / Gearbox

Eixo intermediário / Eje intermedio / Intermediate shaft				F 15047	0019801402	STRB
				F 19010		CRBS
				F 19039		CRBS

Direção / Dirección / Steering

Bomba (dianteiro) / Bomba (delantero) / Pump (front)				6304	11022	BB
--	--	--	--	-------------	-------	----

Eixo Dianteiro / Eje Delantero / Front Axle

Roda / Rueda / Wheel	•			33208 F	184679	TRB
				31308 F	6782631	TRB
		•		6386 / 6320		TRB

Eixo Traseiro / Eje Trasero / Rear Axle

Diferencial - lateral coroa (dir./esq.) / Diferencial - lateral corona (der./izq.) / Differential - crown gear (right/left)				594 / 592 A	183704	TRB
				687 / 672	184637	TRB
Diferencial - lateral coroa (dir.) / Diferencial - lateral corona (der.) / Differential - crown gear (right)				30217 F	184459	TRB
Diferencial - lateral coroa esq. / Diferencial - lateral corona (izq.) / Differential - crown gear (left)				32017 XF	184623	TRB
Diferencial - ligação / Diferencial - enlace / Differential - union				6310	11028	BB
Diferencial - pinhão apoio / Diferencial - piñón apoyo / Differential - support pinion				NJ 2309 F / C3	1523243	CRB
				NUP 2212 F	183703	CRB
Diferencial - pinhão sup. (dianteiro) / Diferencial - piñón sup. (delantero) / Differential - upper pinion (front)				31315 F	181396	TRB
Diferencial - pinhão (dianteiro) / Diferencial - piñón (delantero) / Differential - pinion (front)				31312 F	181609	TRB
				H 913842 / H 913810	184634	TRB
				HM 911245 / HM 911210	184633	TRB

	OUT	IN		Fersa ®	Nº OEM	
---	-----	----	---	----------------	--------	---

VOLVO (SA)

N * NL 10 BR * N * NL 12 BR * N 10BR Mark II * NL 10BR 6x2

Eixo Traseiro / Eje Trasero / Rear Axle

Roda / Rueda / Wheel				32017 XF		TRB
				32017 XF		TRB
		•		32219 F	181086	TRB
Roda / Rueda / Wheel	•			32219 F	181086	TRB
	•			39580 / 39520	184088	TRB
	•			663 / 653	6889594	TRB
		•		683 / 672	181596/181279	TRB
		•		HM 218248 / HM 218210		TRB
	•			HM 220149 / HM 220110		TRB

Embreagem / Embrague / Clutch

Eixo intermediário (traseiro) / Eje intermedio (trasero) / Intermediate shaft (rear)				32310 F	11062	TRB
Garfo de acionamento / Garfo de accionamiento / Drive fork				6005 2RS	183502	BB

Motor / Motor / Engine

Alternador (dianteiro) / Alternador (delantero) / Alternator (front)				6303 2RS / C3	183486	BB
				6303 2RS / C3	6885190 (77...)	BB
Alternador (traseiro) / Alternador (trasero) / Alternator (rear)				6201 2RS / C3	183379	BB
				62201 2RS / C3	244328	BB
				6303 2RS / C3	183486	BB
Bomba d'água - intermediário / Bomba de agua (intermediario) / Water pump - intermediate				6206 2RS	181538	BB
Bomba d'água (dianteiro) / Bomba de agua (delantero) / Water pump (front)				6202 2RS	1660609	BB
				NU 206 FM	1842870	CRB
Bomba d'água (traseiro) / Bomba de agua (trasero) / Water pump (rear)				3206 B	181286	BB2R
Bomba injetora (dianteiro) / Bomba inyectora (delantero) / Injection pump (front)				3207 B	181577	BB2R
Bomba injetora (traseiro) / Bomba inyectora (trasero) / Injection pump (rear)				6206	11013	BB
Motor de partida / Motor de arranque / Starter engine				6201 Z / C3	240453	BB
Polia tensora / Polea tensora / Tensioner pulley				6206 2RS	1544092	BB
Transmissão / Transmisión / Transmission				6206 2RS	11013	BB

Tomada de Força / Toma de Fuerza / Power Take-off

Caixa - Eixo intermediário (dianteiro/traseiro) / Caja - eje intermedio (delantero/trasero) / Box - intermediate shaft (front/rear)				33110 F	184649	TRB
Eixo intermediário / Eje intermedio / Intermediate shaft				6009 C3	183234	BB
				6208 N	184646	BB

NH 12 * FM 12

Caixa de Mudanças / Caja de Cambios / Gearbox

Eixo intermediário / Eje intermedio / Intermediate shaft				33212 F	1652563	TRB
				F 15047	0019801402	STRB
				F 19010		CRBS
				F 19039		CRBS

	OUT	IN		Fersa [®]	Nº OEM	
---	-----	----	---	---------------------------	--------	---

VOLVO (SA)

NH 12 * FM 12

Direção / Dirección / Steering

Bomba (traseiro) / Bomba (traseiro) / Pump (rear)				6304 2RS	181826	BB
---	--	--	--	-----------------	--------	----

Eixo Dianteiro / Eje Delantero / Front Axle

Roda / Rueda / Wheel	•	•		F 200001 A	20967831	KWT
	•	•		F 200003	20967830	KWT

Eixo Traseiro / Eje Trasero / Rear Axle

Diferencial - lateral coroa (dir./esq.) / Diferencial - lateral corona (der./izq.) / Differential - crown gear (right/left)				687 / 672	181596 / 181279	TRB
Diferencial - lateral coroa (dir.) / Diferencial - lateral corona (der.) / Differential - crown gear (right)				30217 F	184459	TRB
				594 / 592 A	181298	TRB
Diferencial - lateral coroa esq. / Diferencial - lateral corona (izq.) / Differential - crown gear (left)				32017 XF	184623	TRB
				594 / 592 A	183704	TRB
Diferencial - pinhão apoio / Diferencial - piñón apoyo / Differential - support pinion				NJ 2309 F / C3	1523243	CRB
Diferencial - pinhão inf. (dianteiro) / Diferencial - piñón inf. (delantero) / Differential - lower pinion (front)				HM 911245 / HM 911210	184633	TRB
Diferencial - pinhão inf. (traseiro) / Diferencial - piñón inf. (trasero) / Differential - lower pinion (rear)				31315 F	181396	TRB
Diferencial - pinhão (dianteiro) / Diferencial - piñón (delantero) / Differential - pinion (front)				31312 F	181609	TRB
Diferencial - pinhão (traseiro) / Diferencial - piñón (trasero) / Differential - pinion (rear)				H 913842 / H 913810	184635	TRB
Roda / Rueda / Wheel	•	•		F 200002 A	21036050	KWT
	•			663 / 653	6889594	TRB
		•		683 / 672	181596/181279	TRB

Motor / Motor / Engine

Acionamento (dianteiro) / Accionamiento (delantero) / Drive (front)				6206 2RS	11013	BB
Ventilador / Ventilador / Fan				6014 C3	19278	BB
				6304 2RS	181826	BB

VM 17 * VM 23 * VM 210

Eixo Traseiro / Eje Trasero / Rear Axle

Roda / Rueda / Wheel	•			F 15156		STRB
		•		32218 F		TRB
	•			580 / 572	184728 / 181128	TRB
		•		594 / 592 A	181299 / 181125	TRB



10

Lists & Adiccional Information

Listas e Informação Adiccional
Listados e Información Adiccional



Fersa Numerical List

Lista Numérica Fersa

Lista Numérica Fersa

10.1

Fersa®	Dimensions / Dimensões / Dimensiones			
	d	D	T	
11BC	-	42,862	-	TRB
11590 / 11520	15,875	42,862	14,288	TRB
12168 / 12303	42,862	76,992	17,464	TRB
12175 / 12303	44,450	76,992	17,464	TRB
1380 / 1328	22,225	52,388	19,368	TRB
14116 / 14276	30,226	69,012	19,845	TRB
14131 / 14276	33,338	69,012	19,845	TRB
14585 / 14525	34,925	68,262	20,638	TRB
15101 / 15245	25,400	62,000	19,050	TRB
15103 S / 15243	26,162	61,912	19,050	TRB
15106 / 15250 X	26,988	63,500	20,638	TRB
17887 / 17831	45,230	79,985	19,842	TRB
25577 / 25523	42,875	82,931	26,988	TRB
25580 / 25520	44,450	82,931	23,812	TRB
25581 / 25520	44,450	82,931	23,813	TRB
25590 / 25520	45,618	82,931	23,812	TRB
25590 / 25522	45,618	83,058	23,876	TRB
25877 / 25820	34,925	73,025	23,812	TRB
25877 / 25821	34,925	73,025	23,812	TRB
25880 / 25820	36,487	73,025	23,812	TRB
2689 / 2631	28,575	66,421	23,812	TRB
2780 / 2720	36,487	76,200	23,812	TRB
2789 / 2720	39,688	76,200	23,812	TRB
28682 / 28622	57,150	97,630	24,608	TRB
28985 / 28921	60,325	100,000	25,400	TRB
29675 / 29630	69,850	120,650	25,400	TRB
29685 / 29620	73,025	112,712	25,400	TRB
30203 F	17,000	40,000	13,250	TRB
30204 F	20,000	47,000	15,250	TRB
30205 F	25,000	52,000	16,250	TRB
30206 F	30,000	62,000	17,250	TRB
30207 F	35,000	72,000	18,250	TRB
30208 F	40,000	80,000	19,750	TRB
30209 F	45,000	85,000	20,750	TRB
30210 F	50,000	90,000	21,750	TRB
30211 F	55,000	100,000	22,750	TRB
30212 F	60,000	110,000	23,750	TRB
30213 F	65,000	120,000	24,750	TRB
30214 F	70,000	125,000	26,250	TRB
30216 F	80,000	140,000	28,250	TRB
30217 F	85,000	150,000	30,500	TRB
30220 F	100,000	180,000	37,000	TRB
30222 F	110,000	200,000	41,000	TRB
30302 F	15,000	42,000	14,250	TRB
30303 F	17,000	47,000	15,250	TRB
30304 F	20,000	52,000	16,250	TRB
30305 F	25,000	62,000	18,250	TRB
30306 F	30,000	72,000	20,750	TRB
30307 F	35,000	80,000	22,750	TRB
30308 F	40,000	90,000	25,250	TRB

Fersa®	Dimensions / Dimensões / Dimensiones			
	d	D	T	
30309 F	45,000	100,000	27,250	TRB
30312 F	60,000	130,000	33,500	TRB
30313 F	65,000	140,000	36,000	TRB
30314 F	70,000	150,000	38,000	TRB
31306 F	30,000	72,000	20,750	TRB
31308 F	40,000	90,000	25,250	TRB
31309 F	45,000	100,000	27,250	TRB
31311 F	55,000	120,000	31,500	TRB
31312 F	60,000	130,000	33,500	TRB
31313 F	65,000	140,000	36,000	TRB
31314 F	70,000	150,000	38,000	TRB
31315 F	75,000	160,000	40,000	TRB
31594 / 31520	34,925	76,200	29,370	TRB
31597 / 31520	36,512	76,200	29,370	TRB
3196 / 3120	33,338	72,626	30,162	TRB
32006 XF	30,000	55,000	17,000	TRB
32007 XF	35,000	62,000	18,000	TRB
32008 XF	40,000	68,000	19,000	TRB
32009 XF	45,000	75,000	20,000	TRB
32010 XF	50,000	80,000	20,000	TRB
32011 XF	55,000	90,000	23,000	TRB
32012 XF	60,000	95,000	23,000	TRB
32014 XF	70,000	110,000	25,000	TRB
32015 XF	75,000	115,000	25,000	TRB
32016 XF	80,000	125,000	29,000	TRB
32017 XF	85,000	130,000	29,000	TRB
32018 XF	90,000	140,000	32,000	TRB
32019 XF	95,000	145,000	32,000	TRB
32020 XF	100,000	150,000	32,000	TRB
32021 XF	105,000	160,000	35,000	TRB
32022 XF	110,000	170,000	38,000	TRB
32024 XF	120,000	180,000	38,000	TRB
3206 B	30,000	62,000	23,800	BB2R
3207 B	35,000	72,000	27,000	BB2R
32205 BF	25,000	52,000	19,250	TRB
32205 F	25,000	52,000	19,250	TRB
32206 F	30,000	62,000	21,250	TRB
32207 F	35,000	72,000	24,250	TRB
32208 F	40,000	80,000	24,750	TRB
32210 F	50,000	90,000	24,750	TRB
32211 F	55,000	100,000	26,750	TRB
32212 F	60,000	110,000	29,750	TRB
32213 F	65,000	120,000	32,750	TRB
32214 F	70,000	125,000	33,250	TRB
32215 F	75,000	130,000	33,250	TRB
32216 F	80,000	140,000	35,250	TRB
32218 F	90,000	160,000	42,500	TRB
32219 F	95,000	170,000	45,500	TRB
32220 F	100,000	180,000	49,000	TRB
32304 F	20,000	52,000	22,250	TRB

Fersa®	Dimensions / Dimensões / Dimensiones			
	d	D	T	
32305 F	25,000	62,000	25,250	TRB
32306 F	30,000	72,000	28,750	TRB
32307 F	35,000	80,000	32,750	TRB
32308 BF	40,000	90,000	35,250	TRB
32308 F	40,000	90,000	35,250	TRB
32309 F	45,000	100,000	38,250	TRB
32310 F	50,000	110,000	42,250	TRB
32311 F	55,000	120,000	45,500	TRB
32312 F	60,000	130,000	48,500	TRB
32313 BF	65,000	140,000	51,000	TRB
32313 F	65,000	140,000	51,000	TRB
32314 BF	70,000	150,000	54,000	TRB
32315 BF	75,000	160,000	58,000	TRB
32315 F	75,000	160,000	58,000	TRB
32316 F	80,000	170,000	61,500	TRB
33011 F	55,000	90,000	27,000	TRB
33017 F	85,000	130,000	36,000	TRB
33018 F	90,000	140,000	39,000	TRB
33019 F	95,000	145,000	39,000	TRB
33020 F	100,000	150,000	39,000	TRB
33021 F	105,000	160,000	43,000	TRB
33022 F	110,000	170,000	47,000	TRB
33109 F	45,000	80,000	26,000	TRB
33110 F	50,000	85,000	26,000	TRB
33111 F	55,000	95,000	30,000	TRB
33112 F	60,000	100,000	30,000	TRB
33113 F	65,000	110,000	34,000	TRB
33114 F	70,000	120,000	37,000	TRB
33115 F	75,000	125,000	37,000	TRB
33116 F	80,000	130,000	37,000	TRB
33117 F	85,000	140,000	41,000	TRB
33205 F	25,000	52,000	22,000	TRB
33207 F	35,000	72,000	28,000	TRB
33208 F	40,000	80,000	32,000	TRB
33209 F	45,000	85,000	32,000	TRB
33210 F	50,000	90,000	32,000	TRB
33212 F	60,000	110,000	38,000	TRB
33213 F	65,000	120,000	41,000	TRB
33214 F	70,000	125,000	41,000	TRB
33215 F	75,000	130,000	41,000	TRB
33275 / 33472	69,850	120,000	29,794	TRB
33281 / 33462	71,438	117,475	30,162	TRB
33287 / 33462	73,025	117,475	30,162	TRB
3382 / 3320	39,688	80,167	29,370	TRB
33885 / 33822	44,450	95,250	27,783	TRB
33889 / 33822	50,800	95,250	27,783	TRB
33895 / 33821	53,975	95,250	27,783	TRB
33895 / 33822	53,975	95,250	27,783	TRB
34274 / 34492 A	69,952	125,052	47,450	TRB
34306 / 34478	77,788	121,442	24,608	TRB
3585 / 3525	41,275	87,312	30,162	TRB
3586 / 3525	45,237	87,312	30,163	TRB
368 A / 362 A	50,800	88,900	20,638	TRB
368 A / 362 X	50,800	90,000	25,000	TRB
368 S / 362	51,592	90,000	20,000	TRB
37431 / 37625	109,538	158,750	23,020	TRB
37431 A / 37625	109,538	158,750	23,020	TRB

Fersa®	Dimensions / Dimensões / Dimensiones			
	d	D	T	
3775 / 3720	50,800	93,264	30,163	TRB
3780 / 3720	50,800	93,264	30,162	TRB
3782 / 3720	44,450	93,264	30,162	TRB
387 / 382 A	57,150	96,838	21,000	TRB
387 A / 382 A	57,150	96,838	21,000	TRB
387 A / 382 S	57,150	96,838	25,400	TRB
387 A / 383 A	57,150	100,000	21,000	TRB
387 AS / 382 A	57,150	96,838	21,000	TRB
388 A / 382	57,531	98,425	21,000	TRB
39250 / 39412	63,500	104,775	21,433	TRB
395 A / 394 A	66,675	110,000	22,000	TRB
39580 / 39520	57,150	112,712	30,162	TRB
39581 / 39520	57,150	112,712	30,162	TRB
39585 / 39520	63,500	112,712	30,162	TRB
39590 / 39520	66,675	112,712	30,162	TRB
3982 / 3920	63,500	112,712	30,162	TRB
3984 / 3920	66,675	112,712	30,162	TRB
3994 / 3920	66,675	112,712	30,162	TRB
42346 / 42584	87,960	148,430	28,575	TRB
42350 / 42584	88,900	148,430	28,575	TRB
42368 / 42584	93,662	148,430	28,575	TRB
42381 / 42584	96,838	148,430	28,575	TRB
42688 / 42620	76,200	127,000	30,162	TRB
45284 / 45220	50,800	104,775	30,162	TRB
45291 / 45220	57,150	104,775	30,162	TRB
469 / 453	57,150	107,950	27,975	TRB
469 / 453 X	57,150	104,775	30,162	TRB
47487 / 47420 A	69,850	120,000	32,545	TRB
47490 / 47420	71,438	120,000	32,545	TRB
47686 / 47620	82,550	133,350	33,338	TRB
47890 / 47820	92,075	146,050	33,338	TRB
482 / 472	69,850	120,000	29,794	TRB
495 A / 493	76,200	136,525	30,163	TRB
495 AX / 493	76,200	136,525	30,163	TRB
496 / 493	80,962	136,525	30,163	TRB
497 / 492 A	85,725	133,350	30,163	TRB
497 / 493	85,725	136,525	30,163	TRB
498 / 492 A	84,138	133,350	30,163	TRB
498 A / 492 A	84,138	133,350	30,163	TRB
498 / 493	84,138	136,525	30,163	TRB
52400 / 52618	101,600	157,162	36,512	TRB
53178 / 53377	44,450	95,250	30,958	TRB
537 / 532 X	50,800	107,950	36,512	TRB
55200 C / 55437	50,800	111,125	30,162	TRB
55206 C / 55437	52,388	111,125	30,162	TRB
555 S / 552 A	57,150	123,825	38,100	TRB
559 / 552 A	63,500	123,825	38,100	TRB
56425 / 56650	107,950	165,100	36,512	TRB
567 / 563	73,025	127,000	36,512	TRB
580 / 572	82,550	139,992	36,512	TRB
580 / 572 A	82,550	139,982	35,250	TRB
581 / 572	80,962	139,992	36,513	TRB
59162 / 59412	41,275	104,775	36,512	TRB
59175 / 59412	44,450	104,775	36,512	TRB
594 / 592	95,250	152,400	39,688	TRB
594 / 592 A	95,250	152,400	39,688	TRB
594 A / 592 A	95,250	152,400	39,688	TRB

Fersa®	Dimensions / Dimensões / Dimensiones			
	d	D	T	
598 A / 592 A	92,075	152,400	39,688	TRB
598 A / 593 X	92,075	150,000	35,992	TRB
6000 2RS / C3	10,000	26,000	8,000	BB
6001	12,000	28,000	8,000	BB
6001 2RS / C3	12,000	28,000	8,000	BB
6001 C3	12,000	28,000	8,000	BB
6002 2RS / C3	15,000	32,000	9,000	BB
6003 2RS	17,000	35,000	10,000	BB
6003 2RS / C3	17,000	35,000	10,000	BB
6004	20,000	42,000	12,000	BB
6004 2RS	20,000	42,000	12,000	BB
6004 2RS / C3	20,000	42,000	12,000	BB
6004 Z	20,000	42,000	12,000	BB
6004 ZZ / C3	20,000	42,000	12,000	BB
6005	25,000	47,000	12,000	BB
6005 2RS	25,000	47,000	12,000	BB
6005 2RS / C3	25,000	47,000	12,000	BB
6005 ZZ / C3	25,000	47,000	12,000	BB
6006	30,000	55,000	13,000	BB
6006 2RS	30,000	55,000	13,000	BB
6006 2RS / C3	30,000	55,000	13,000	BB
6006 RS / C3	30,000	55,000	13,000	BB
6006 ZZ / C3	30,000	55,000	13,000	BB
6007	35,000	62,000	14,000	BB
6007 2RS	35,000	62,000	14,000	BB
6007 2RS / C3	35,000	62,000	14,000	BB
6007 C3	35,000	62,000	14,000	BB
6007 N	35,000	62,000	14,000	BB
6008	40,000	68,000	15,000	BB
6008 2RS	40,000	68,000	15,000	BB
6008 Z	40,000	68,000	15,000	BB
6009	45,000	75,000	16,000	BB
6009 2RS	45,000	75,000	16,000	BB
6009 C3	45,000	75,000	16,000	BB
6009 NR	45,000	75,000	16,000	BB
6009 ZZ	45,000	75,000	16,000	BB
6010	50,000	80,000	16,000	BB
6010 2RS	50,000	80,000	16,000	BB
6010 C3	50,000	80,000	16,000	BB
6010 Z	50,000	80,000	16,000	BB
6011	55,000	90,000	18,000	BB
6011 C3	55,000	90,000	18,000	BB
6011 ZZ	55,000	90,000	18,000	BB
6013	65,000	100,000	18,000	BB
6014	70,000	110,000	20,000	BB
6014 2RS	70,000	110,000	20,000	BB
6014 2RS / C3	70,000	110,000	20,000	BB
6014 2RS / C4	70,000	110,000	20,000	BB
6014 C3	70,000	110,000	20,000	BB
6015 Z	75,000	115,000	20,000	BB
6016 2RS / C3	80,000	125,000	22,000	BB
6017 NR	85,000	130,000	22,000	BB
608 2RS / C3	8,000	22,000	7,000	BB
61909	45,000	68,000	12,000	BB
6200 2RS	10,000	30,000	9,000	BB
6200 2RS / C3	10,000	30,000	9,000	BB
6201	12,000	32,000	10,000	BB

Fersa®	Dimensions / Dimensões / Dimensiones			
	d	D	T	
6201 2RS	12,000	32,000	10,000	BB
6201 2RS / C3	12,000	32,000	10,000	BB
6201 N 2RS / C3	12,000	32,000	10,000	BB
6201 RS / C3	12,000	32,000	10,000	BB
6201 Z	12,000	32,000	10,000	BB
6201 Z / C3	12,000	32,000	10,000	BB
6201 ZZ	12,000	32,000	10,000	BB
6201 ZZ / C3	12,000	32,000	10,000	BB
6202	15,000	35,000	11,000	BB
6202 2RS	15,000	35,000	11,000	BB
6202 2RS / C3	15,000	35,000	11,000	BB
6202 C3	15,000	35,000	11,000	BB
6202 Z	15,000	35,000	11,000	BB
6202 Z / C3	15,000	35,000	11,000	BB
6202 ZZ	15,000	35,000	11,000	BB
6202 ZZ / C3	15,000	35,000	11,000	BB
6203	17,000	40,000	12,000	BB
6203 2RS	17,000	40,000	12,000	BB
6203 2RS / C3	17,000	40,000	12,000	BB
6203 C3	17,000	40,000	12,000	BB
6203 Z	17,000	40,000	12,000	BB
6203 ZZ	17,000	40,000	12,000	BB
6203 ZZ / C3	17,000	40,000	12,000	BB
6204	20,000	47,000	14,000	BB
6204 2RS	20,000	47,000	14,000	BB
6204 2RS / C3	20,000	47,000	14,000	BB
6204 C3	20,000	47,000	14,000	BB
6204 Z	20,000	47,000	14,000	BB
6204 ZZ	20,000	47,000	14,000	BB
6204 ZZ / C3	20,000	47,000	14,000	BB
6205	25,000	52,000	15,000	BB
6205 2RS	25,000	52,000	15,000	BB
6205 2RS / C3	25,000	52,000	15,000	BB
6205 C3	25,000	52,000	15,000	BB
6205 RS	25,000	52,000	15,000	BB
6205 RS / C3	25,000	52,000	15,000	BB
6205 Z	25,000	52,000	15,000	BB
6205 ZZ	25,000	52,000	15,000	BB
6205 ZZ / C3	25,000	52,000	15,000	BB
6206	30,000	62,000	16,000	BB
6206 2RS	30,000	62,000	16,000	BB
6206 2RS / C3	30,000	62,000	16,000	BB
6206 2RS / C4	30,000	62,000	16,000	BB
6206 C3	30,000	62,000	16,000	BB
6206 NR	30,000	62,000	16,000	BB
6206 NR 2RS	30,000	62,000	16,000	BB
6206 Z	30,000	62,000	16,000	BB
6206 ZZ	30,000	62,000	16,000	BB
6206 ZZ / C3	30,000	62,000	16,000	BB
6207	35,000	72,000	17,000	BB
6207 2RS	35,000	72,000	17,000	BB
6207 2RS / C3	35,000	72,000	17,000	BB
6207 C3	35,000	72,000	17,000	BB
6207 NR	35,000	72,000	17,000	BB
6207 NR 2RS	35,000	72,000	17,000	BB
6207 Z	35,000	72,000	17,000	BB
6207 ZN / C3	35,000	72,000	17,000	BB

Fersa®	Dimensions / Dimensões / Dimensiones			
	d	D	T	
6207 ZNR	35,000	72,000	17,000	BB
6207 ZZ	35,000	72,000	17,000	BB
6208	40,000	80,000	18,000	BB
6208 2RS	40,000	80,000	18,000	BB
6208 2RS / C3	40,000	80,000	18,000	BB
6208 N	40,000	80,000	18,000	BB
6208 ZZ	40,000	80,000	18,000	BB
6209	45,000	85,000	19,000	BB
6209 2RS	45,000	85,000	19,000	BB
6209 C3	45,000	85,000	19,000	BB
6209 NR	45,000	85,000	19,000	BB
6209 NR / C3	45,000	85,000	19,000	BB
6209 ZZ	45,000	85,000	19,000	BB
6210	50,000	90,000	20,000	BB
6210 2RS	50,000	90,000	20,000	BB
6210 Z	50,000	90,000	20,000	BB
6210 ZZ	50,000	90,000	20,000	BB
6210 ZZ NR	50,000	90,000	20,000	BB
6211	55,000	100,000	21,000	BB
6211 2RS	55,000	100,000	21,000	BB
6211 C3	55,000	100,000	21,000	BB
6211 N / C3	55,000	100,000	21,000	BB
6211 Z	55,000	100,000	21,000	BB
6211 ZNR	55,000	100,000	21,000	BB
6212	60,000	110,000	22,000	BB
6212 2RS	60,000	110,000	22,000	BB
6212 NR	60,000	110,000	22,000	BB
6212 ZNR	60,000	110,000	22,000	BB
6213 C3	65,000	120,000	23,000	BB
6214	70,000	125,000	24,000	BB
6215 C3	75,000	130,000	25,000	BB
6215 NR / C3	75,000	130,000	25,000	BB
6216 C3	80,000	140,000	26,000	BB
6218 C3	90,000	160,000	30,000	BB
62201 2RS / C3	12,000	32,000	14,000	BB
62202 2RS / C3	15,000	35,000	14,000	BB
62204 2RS	20,000	47,000	18,000	BB
62205 2RS	25,000	52,000	18,000	BB
62206 2RS	30,000	62,000	20,000	BB
6300 2RS / C3	10,000	35,000	11,000	BB
6301 2RS / C3	12,000	37,000	12,000	BB
6302	15,000	42,000	13,000	BB
6302 2RS	15,000	42,000	13,000	BB
6302 2RS / C3	15,000	42,000	13,000	BB
6302 Z	15,000	42,000	13,000	BB
6302 ZZ / C3	15,000	42,000	13,000	BB
6303	17,000	47,000	14,000	BB
6303 2RS	17,000	47,000	14,000	BB
6303 2RS / C3	17,000	47,000	14,000	BB
6303 C3	17,000	47,000	14,000	BB
6303 RS / C3	17,000	47,000	14,000	BB
6303 RSR / C3	17,000	47,000	14,000	BB
6303 Z	17,000	47,000	14,000	BB
6303 Z / C3	17,000	47,000	14,000	BB
6303 ZZ	17,000	47,000	14,000	BB
6303 ZZ / C3	17,000	47,000	14,000	BB
6304	20,000	52,000	15,000	BB

Fersa®	Dimensions / Dimensões / Dimensiones			
	d	D	T	
6304 2RS	20,000	52,000	15,000	BB
6304 2RS / C3	20,000	52,000	15,000	BB
6304 C3	20,000	52,000	15,000	BB
6304 C4	20,000	52,000	15,000	BB
6304 ZZ	20,000	52,000	15,000	BB
6304 ZZ / C3	20,000	52,000	15,000	BB
6305	25,000	62,000	17,000	BB
6305 2RS	25,000	62,000	17,000	BB
6305 2RS / C3	25,000	62,000	17,000	BB
6305 C3	25,000	62,000	17,000	BB
6305 ZZ / C3	25,000	62,000	17,000	BB
6306	30,000	72,000	19,000	BB
6306 2RS	30,000	72,000	19,000	BB
6306 2RS / C3	30,000	72,000	19,000	BB
6306 C3	30,000	72,000	19,000	BB
6306 D25 2RS / C3	25,000	72,000	19,000	BB
6306 NR	30,000	72,000	19,000	BB
6306 NR 2RS / C3	30,000	72,000	19,000	BB
6306 ZNR	30,000	72,000	19,000	BB
6306 ZNR / C3	30,000	72,000	19,000	BB
6306 ZZ	30,000	72,000	19,000	BB
6306 ZZ / C3	30,000	72,000	19,000	BB
6307	35,000	80,000	21,000	BB
6307 2RS	35,000	80,000	21,000	BB
6307 2RS / C3	35,000	80,000	21,000	BB
6307 C3	35,000	80,000	21,000	BB
6307 NR	35,000	80,000	21,000	BB
6307 NR 2RS	35,000	80,000	21,000	BB
6307 RS	35,000	80,000	21,000	BB
6307 Z	35,000	80,000	21,000	BB
6307 ZNR	35,000	80,000	21,000	BB
6308	40,000	90,000	23,000	BB
6308 2RS	40,000	90,000	23,000	BB
6308 N	40,000	90,000	23,000	BB
6308 NR	40,000	90,000	23,000	BB
6308 NR / C4	40,000	90,000	23,000	BB
6308 ZNR	40,000	90,000	23,000	BB
6308 ZNR / C3	40,000	90,000	23,000	BB
6309	45,000	100,000	25,000	BB
6309 2RS	45,000	100,000	25,000	BB
6309 NR	45,000	100,000	25,000	BB
6309 NR / C3	45,000	100,000	25,000	BB
6309 Z / C3	45,000	100,000	25,000	BB
6309 ZNR / C3	45,000	100,000	25,000	BB
6310	50,000	110,000	27,000	BB
6310 2RS	50,000	110,000	27,000	BB
6310 C3	50,000	110,000	27,000	BB
6311	55,000	120,000	29,000	BB
6311 C3	55,000	120,000	29,000	BB
6311 NR / C3	55,000	120,000	29,000	BB
6312 C3	60,000	130,000	31,000	BB
6312 NR / C3	60,000	130,000	31,000	BB
6313 C3	65,000	140,000	33,000	BB
6314	70,000	150,000	35,000	BB
6314 C3	70,000	150,000	35,000	BB
6314 N / C3	70,000	150,000	35,000	BB
6314 NR / C3	70,000	150,000	35,000	BB

Fersa®	Dimensions / Dimensões / Dimensiones			
	d	D	T	
6386 / 6320	66,675	135,755	53,975	TRB
6403 2RS / C3	17,000	62,000	17,000	BB
6403 C3	17,000	62,000	17,000	BB
6407 C3	35,000	100,000	25,000	BB
6408	40,000	110,000	27,000	BB
6408 NR / C3	40,000	110,000	27,000	BB
6409	45,000	120,000	29,000	BB
6409 C3	45,000	120,000	29,000	BB
6409 NR / C3	45,000	120,000	29,000	BB
641 / 632	66,675	136,525	41,275	TRB
64450 / 64700	114,300	177,800	41,275	TRB
6461 A / 6420	76,200	149,225	53,975	TRB
65237 / 65500	60,325	127,000	44,450	TRB
66225 / 66462	57,150	117,475	33,338	TRB
663 / 652	82,550	152,400	41,275	TRB
663 / 653	82,550	146,050	41,275	TRB
665 / 652	85,725	152,400	41,275	TRB
665 / 653	85,725	146,050	41,275	TRB
681 A / 672	92,075	168,275	41,275	TRB
683 / 672	95,250	168,275	41,275	TRB
68450 / 68712	114,300	180,975	34,925	TRB
68462 / 68712	117,475	180,975	34,925	TRB
687 / 672	101,600	168,275	41,275	TRB
7210 B	50,000	90,000	20,000	BB
72188 C / 72487	47,625	123,825	36,152	TRB
72200 C / 72487	50,800	123,825	36,512	TRB
72212 C / 72487	53,975	123,825	36,152	TRB
72218 C / 72487	55,562	123,825	36,152	TRB
749 / 742	85,026	150,089	44,450	TRB
760 / 752	90,488	161,925	47,625	TRB
78215 C / 78551	53,975	140,030	36,513	TRB
78225 C / 78551	57,150	140,030	36,513	TRB
9278 / 9220	68,262	161,925	49,212	TRB
9285 / 9220	76,200	161,925	49,212	TRB
A 6075 / A 6157	19,050	39,992	12,014	TRB
F 15029	29,000	50,292	14,224	TRBS
F 15036	35,000	60,000	15,875	TRBS
F 15041	25,000	52,000	37,000	TRBDR
F 15043	25,000	55,000	43,000	TRBDR
F 15044	35,000	65,000	35,000	TRBDR
F 15046	60,000	130,000	39,000	TRBS
F 15047	55,000	100,000	35,000	TRBS
F 15048	75,000	180,000	63,500	TRBS
F 15051 C	70,000	130,000	57,000	TRBS
F 15058	63,500	105,000	23,000	TRBS
F 15067	29,000	53,000	37,000	TRBDR
F 15071	75,000	160,000	58,000	TRBS
F 15076	110,000	170,000	38,000	TRBS
F 15082	65,000	145,000	36,000	TRBS
F 15083	65,000	145,000	39,500	TRBS
F 15097	68,000	127,000	115,000	HWT
F 15116	70,000	150,000	39,800	TRBS
F 15128	27,000	53,000	43,000	TRBDR
F 15139	60,000	96,500	29,700	BBS
F 15140	60,000	96,500	25,700	BBS
F 15141	55,000	91,500	25,000	BBS
F 15151	27,000	52,000	45,0 / 50,0	TRBDR

Fersa®	Dimensions / Dimensões / Dimensiones			
	d	D	T	
F 15156	80,000	140,000	39,250	TRBS
F 15158	60,000	135,000	37,000	TRBS
F 15159	65,000	165,000	40,000	TRBS
F 15165	109,538	158,700	23,020	TRBS
F 15173	35,000	68,000	48,000	TRBDR
F 15175	25,000	55,000	45,000	TRBDR
F 15183	65,000	165,000	36,000	TRBS
F 16013	30,000	120,000	68,500	BBDRAC
F 16019	34,000	64,000	37,000	BBDRAC
F 16020	34,000	66,000	37,000	BBDRAC
F 16021	35,000	65,000	35,000	BBDRAC
F 16023	35,000	66,000	37,000	BBDRAC
F 16026	35,000	72,000	33,000	BBDRAC
F 16028	35,000	136,000	75,000	BBDRAC
F 16029	37,000	72,000	33,000	BBDRAC
F 16030	37,000	72,000	37,000	BBDRAC
F 16032	37,000	74,000	45,000	BBDRAC
F 16034	37,990	74,020	36,000	BBDRAC
F 16035	39,000	68,000	37,000	BBDRAC
F 16036	39,000	72,000	37,000	BBDRAC
F 16037	39,000	74,000	39,000	BBDRAC
F 16038	39,000	75,000	37,000	BBDRAC
F 16039	40,000	72,000	37,000	BBDRAC
F 16040	40,000	74,000	40,000	BBDRAC
F 16044	39,980	108,000	32,000	BBDRAC
F 16048	42,000	82,000	36,000	BBDRAC
F 16051	42,000	84,030	39,000	BBDRAC
F 16052	43,000	79,000	41,000	BBDRAC
F 16054	43,000	82,000	37,000	BBDRAC
F 16055	40,000	75,000	37,000	BBDRAC
F 16057	38,100	70,000	37,000	BBDRAC
F 16058	45,000	84,000	39,000	BBDRAC
F 16059	45,000	84,020	39,000	BBDRAC
F 16065	30,000	120,000	63,500	BBDRAC
F 16078	43,000	82,000	45,000	BBDRAC
F 16081	42,000	76,000	38,000	BBDRAC
F 16083	34,000	67,000	37,000	BBDRAC
F 16088	42,000	80,000	45,000	BBDRAC
F 16097	35,000	50,000	20,000	BBDRAC
F 16098	30,000	55,000	23,000	BBDRAC
F 16099	35,000	50,000	20,000	BBDRAC
F 16100	35,000	55,000	20,000	BBDRAC
F 16101	35,000	52,000	22,000	BBDRAC
F 16102	40,000	62,000	24,000	BBDRAC
F 16103	40,000	62,000	20,625	BBDRAC
F 16104	30,000	62,000	27,000	BBDRAC
F 16110	39,000	72,000	37,000	BBDRAC
F 16194	42,000	76,000	39,000	BBDRAC
F 16195	42,000	76,000	40,000	BBDRAC
F 16196	43,000	76,000	43,000	BBDRAC
F 16197	42,000	76,000	43,000	BBDRAC
F 16198	40,000	46,000	33,000	BBDRAC
F 16199	47,000	81,000	53,000	BBDRAC
F 18018	25,000	62,020	24,000	BBS
F 18021	28,000	66,000	18,000	BBS
F 18024	25,995	68,000	19,700	BBS
F 18031	63,500	102,000	20,570	BBS

Fersa®	Dimensions / Dimensões / Dimensiones			
	d	D	T	
F 18039	36,513	68,000	15,000	BBS
F 18040	63,500	100,000	23,000	BBS
F 18041	50,000	90,000	20,000	BBS
F 19001	45,000	100,000	36,000	CRBS
F 19002	45,000	100,000	25,000	CRBS
F 19008	80,000	150,000	28,000	CRBS
F 19009	60,000	130,000	31,000	CRBS
F 19010	65,000	140,000	33,350	CRBS
F 19011	60,000	110,000	22,000	CRBS
F 19012	35,000	80,000	23,000	CRBS
F 19013	40,000	90,000	27,000	CRBS
F 19015	45,000	95,000	32,000	CRBS
F 19016	63,000	97,450	34,750	CRBS
F 19019	30,000	60,000	26,000	CRBS
F 19020	35,000	80,000	22,000	CRBS
F 19029	25,000	52,000	21,000	CRBS
F 19033	40,000	90,000	25,000	CRBS
F 19034	40,000	90,000	23,000	CRBS
F 19039	80,000	140,000	33,500	CRBS
F 19042	60,000	110,000	28,000	CRBS
F 19043	34,993	80,000	23,000	CRBS
F 19044	45,000	100,000	25,000	CRBS
F 19046	50,000	100,000	25,000	CRBS
F 19047	60,000	116,000	28,000	CRBS
F 19048	36,000	56,300	20,000	CRBS
F 19075	30,000	110,000	32,300	CRBS
F 19076	38,000	94,000	33,000	CRBS
F 200001 A	68,000	125,000	115,000	KWT
F 200002 A	93,800	148,000	135,000	KWT
F 200003	58,000	110,000	115,000	KWT
F 200004	105,000	160,000	140,000	KWT
F 300006	45,000	120,000	84,900	CWT
H 715334 / H 715311	61,912	136,525	46,038	TRB
H 715343 / H 715311	68,262	136,525	46,038	TRB
H 715345 / H 715311	71,438	136,525	46,038	TRB
H 913842 / H 913810	61,912	146,050	41,275	TRB
H 914841 / H 914811	68,262	152,400	47,626	TRB
HM 212044 / HM 212011	60,325	122,238	38,100	TRB
HM 212047 / HM 212011	63,500	122,238	38,100	TRB
HM 212049 / HM 212011	66,675	122,238	38,100	TRB
HM 218248 / HM 218210	89,974	146,975	40,000	TRB
HM 220149 / HM 220110	99,975	156,975	42,000	TRB
HM 516449 / HM 516410	82,550	133,350	39,687	TRB
HM 518445 / HM 518410	88,900	152,400	39,688	TRB
HM 803145 / HM 803110	41,275	88,900	30,163	TRB
HM 803146 / HM 803110	41,275	88,900	30,162	TRB
HM 803149 / HM 803110	44,450	88,900	30,162	TRB
HM 804843 / HM 804810	44,450	95,250	30,162	TRB
HM 804846 / HM 804810	47,625	95,250	30,162	TRB
HM 807040 / HM 807010	44,450	104,775	36,512	TRB

Fersa®	Dimensions / Dimensões / Dimensiones			
	d	D	T	
HM 807046 / HM 807010	50,800	104,775	36,512	TRB
HM 807046 / HM 807011	50,800	104,775	36,512	TRB
HM 807049 / HM 807010	53,975	104,775	36,512	TRB
HM 813841 / HM 813810	60,325	127,000	36,512	TRB
HM 813842 / HM 813810	63,500	127,000	36,512	TRB
HM 813843 / HM 813810	61,912	127,000	36,512	TRB
HM 813849 / HM 813810	71,438	127,000	36,512	TRB
HM 88542 / HM 88510	31,750	73,025	29,370	TRB
HM 88649 / HM 88610	34,925	72,233	25,400	TRB
HM 89443 / HM 89411	33,338	76,200	29,369	TRB
HM 89449 / HM 89410	36,512	76,200	29,370	TRB
HM 903249 / HM 903210	44,450	95,250	30,958	TRB
HM 905843 / HM 905810	44,987	104,986	32,512	TRB
HM 911245 / HM 911210	60,325	130,175	36,512	TRB
JD 6549 / JD 6510	65,000	110,000	31,000	TRB
JF 10049 / JF 10010	100,000	165,000	47,000	TRB
JF 4049 / JF 4010	40,000	85,000	33,000	TRB
JF 4549 / JF 4510	45,000	95,000	36,000	TRB
JF 5049 / JF 5010	50,000	100,000	36,000	TRB
JF 6049 / JF 6010	60,000	115,000	40,000	TRB
JH 211749 / JH 211710	65,000	120,000	39,000	TRB
JHM 522649 / JHM 522610	110,000	180,000	47,000	TRB
JHM 720249 / JHM 720210	100,000	160,000	41,000	TRB
JL 26749 F / JL 26710	32,000	53,000	14,500	TRB
JL 69349 / JL 69310	38,000	63,000	17,000	TRB
JL 69349 X / JL 69310	38,000	63,000	17,000	TRB
JL 819349 / JL 819310	95,000	135,000	20,000	TRB
JLM 104946 / JLM 104911 A	50,000	82,550	23,148	TRB
JLM 104948 / JLM 104910	50,000	82,000	21,500	TRB
JLM 506849 A / JLM 506811	55,000	90,000	25,000	TRB
JLM 508748 / JLM 508710	60,000	95,000	24,000	TRB
JLM 710949 / JLM 710910	65,000	105,000	24,000	TRB
JLM 710949 C / JLM 710910	65,000	105,000	24,000	TRB
JLM 714149 / JLM 714110	75,000	115,000	25,000	TRB
JM 205149 / JM 205110	50,000	90,000	28,000	TRB
JM 207049 / JM 207010	55,000	95,000	29,000	TRB
JM 207049 A / JM 207010	55,000	95,000	29,000	TRB
JM 511946 / JM 511910	65,000	110,000	28,000	TRB
JM 714249 / JM 714210	75,000	120,000	31,000	TRB
JM 716649 / JM 716610	85,000	130,000	30,000	TRB

Fersa®	Dimensions / Dimensões / Dimensiones			
	d	D	T	
JM 720249 / JM 720210	100,000	155,000	36,000	TRB
JP 12049 / JP 12010	120,000	170,000	27,000	TRB
JP 12049 A / JP 12010	120,000	170,000	27,000	TRB
JW 7049 / JW 7010	70,000	140,000	39,000	TRB
L 44643 / L 44610	25,400	50,292	14,224	TRB
L 44649 / L 44610	26,988	50,292	14,224	TRB
L 45449 / L 45410	29,000	50,292	14,224	TRB
L 68149 / L 68110	34,987	59,131	15,875	TRB
L 68149 / L 68111	34,987	59,975	15,875	TRB
LM 102949 / LM 102910	45,242	73,431	19,558	TRB
LM 104949 / LM 104910	50,800	82,000	21,500	TRB
LM 104949 / LM 104911	50,800	82,550	21,590	TRB
LM 104949 / LM 104912	50,800	82,931	21,590	TRB
LM 11749 / LM 11710	17,462	39,878	13,843	TRB
LM 11949 / LM 11910	19,050	45,237	15,494	TRB
LM 12748 / LM 12710	21,430	45,237	15,494	TRB
LM 12749 / LM 12710	21,986	45,237	15,494	TRB
LM 12749 / LM 12711	21,986	45,974	15,494	TRB
LM 29749 / LM 29710	38,100	65,088	18,034	TRB
LM 29749 / LM 29711	38,100	65,088	19,812	TRB
LM 300849 / LM 300811	40,987	67,975	17,500	TRB
LM 48548 / LM 48510	34,925	65,088	18,034	TRB
LM 501349 / LM 501310	41,275	73,431	19,558	TRB
LM 501349 / LM 501314	41,275	73,431	21,430	TRB
LM 501349 / LM 501310	41,275	73,431	19,558	TRB
LM 503349 A / LM 503310	45,987	74,976	18,000	TRB
LM 506849 / LM 506810	55,000	90,000	23,000	TRB
LM 603049 / LM 603011	45,242	77,788	19,842	TRB
LM 603049 / LM 603012	45,242	77,788	21,430	TRB
LM 67048 / LM 67010	31,750	59,131	15,875	TRB
LM 78349 / LM 78310 A	34,987	61,973	16,702	TRB
LM 806649 / LM 806610	53,975	88,900	19,050	TRB
M 12649 / M 12610	21,430	50,005	17,526	TRB
M 802048 / M 802011	41,275	82,550	26,543	TRB
M 804049 / M 804010	47,625	88,900	25,400	TRB
M 84548 / M 84510	25,400	57,150	19,431	TRB
M 86647 / M 86610	28,575	64,292	21,433	TRB
M 86649 / M 86610	30,162	64,292	21,433	TRB
M 88043 / M 88010	30,162	68,262	22,225	TRB
M 88048 / M 88010	33,338	68,262	22,225	TRB
N 207 / C3	35,000	72,000	17,000	CRB
N 2211 FMNR / C3	55,000	100,000	25,000	CRB
N 306 F	30,000	72,000	19,000	CRB
N 307 FM	35,000	80,000	21,000	CRB

Fersa®	Dimensions / Dimensões / Dimensiones			
	d	D	T	
N 309 FM	45,000	100,000	25,000	CRB
NJ 205 / C3	25,000	52,000	15,000	CRB
NJ 206	30,000	62,000	16,000	CRB
NJ 2206 FM	30,000	62,000	20,000	CRB
NJ 2211 FM	55,000	100,000	25,000	CRB
NJ 2309 F / C3	45,000	100,000	36,000	CRB
NJ 304 FM	20,000	52,000	15,000	CRB
NJ 304 FMN	20,000	52,000	15,000	CRB
NJ 305 C3	25,000	62,000	17,000	CRB
NJ 305 FM / C3	25,000	62,000	17,000	CRB
NJ 307 FM	35,000	80,000	21,000	CRB
NJ 309 FM	45,000	100,000	25,000	CRB
NJ 309 C3	45,000	100,000	25,000	CRB
NJ 309 FM	45,000	100,000	25,000	CRB
NJ 309 FM / C3	45,000	100,000	25,000	CRB
NU 1011 FM	55,000	90,000	18,000	CRB
NU 206 FM	30,000	62,000	16,000	CRB
NU 208 FM	40,000	80,000	18,000	CRB
NU 209 FMN	45,000	85,000	19,000	CRB
NU 209 FMN / C3	45,000	85,000	190,000	CRB
NU 2205	25,000	52,000	18,000	CRB
NU 303 FM	17,000	47,000	14,000	CRB
NU 303 FM / C3	17,000	47,000	14,000	CRB
NU 303 FMN	17,000	47,000	14,000	CRB
NU 310 FM	50,000	110,000	27,000	CRB
NU 310 FM / C3	50,000	110,000	27,000	CRB
NUP 206 FM	30,000	62,000	16,000	CRB
NUP 212 FM	60,000	110,000	22,000	CRB
NUP 2205	25,000	52,000	18,000	CRB
NUP 2212 F	60,000	110,000	28,000	CRB
NUP 2212 FMN	60,000	110,000	28,000	CRB
NUP 304 FM	20,000	52,000	15,000	CRB
NUP 308 FM	40,000	90,000	23,000	CRB
NUP 309	45,000	100,000	25,000	CRB
NUP 309 C3	45,000	100,000	25,000	CRB
NUP 309 FM	45,000	100,000	25,000	CRB
NUP 309 FM / C3	45,000	100,000	25,000	CRB
NUP 310 FM / C3	50,000	110,000	27,000	CRB
NUP 310 FMN / C3	50,000	110,000	27,000	CRB
NUP 311 FM	55,000	120,000	29,000	CRB
NUP 311 FM / C3	55,000	120,000	29,000	CRB
NUP 311 FMNR / C3	55,000	120,000	29,000	CRB
NUP 314 FM	70,000	150,000	35,000	CRB
NUP 314 FM / C3	70,000	150,000	35,000	CRB
NUP 314 FMN / C3	70,000	150,000	35,000	CRB
NUP 314 FMNR	70,000	150,000	35,000	CRB
NUP 314 FMNR / C3	70,000	150,000	35,000	CRB
QJ 208 FM	40,000	80,000	18,000	BB4PAC
QJ 209 FM	45,000	85,000	19,000	BB4PAC
QJ 212 FM	60,000	110,000	22,000	BB4PAC
QJ 309 FM	45,000	100,000	25,000	BB4PAC
RMS 9 2RS / C4	28,575	71,438	20,638	BB
T 163	41,529	72,619	21,433	TRBT
T 182	46,279	82,956	23,812	TRBT
U 298 / U 261 L	34,987	64,975	18,100	U Series
U 399 / U 360 L	39,688	73,025	19,400	U Series
U 497 / U 460 L	44,987	79,975	24,000	U Series

Fersa Dimensional List

Lista Dimensional Fersa

Lista Dimensional Fersa

10.2

Dimensions / Dimensões / Dimensiones			Fersa®	
d	D	T		
10,000	26,000	8,000	6000 2RS / C3	BB
10,000	30,000	9,000	6200 2RS	BB
10,000	30,000	9,000	6200 2RS / C3	BB
10,000	35,000	11,000	6300 2RS / C3	BB
12,000	28,000	8,000	6001	BB
12,000	28,000	8,000	6001 2RS / C3	BB
12,000	28,000	8,000	6001 C3	BB
12,000	32,000	10,000	6201	BB
12,000	32,000	10,000	6201 2RS	BB
12,000	32,000	10,000	6201 2RS / C3	BB
12,000	32,000	10,000	6201 N 2RS / C3	BB
12,000	32,000	10,000	6201 RS / C3	BB
12,000	32,000	10,000	6201 Z	BB
12,000	32,000	10,000	6201 Z / C3	BB
12,000	32,000	10,000	6201 ZZ	BB
12,000	32,000	10,000	6201 ZZ / C3	BB
12,000	32,000	14,000	62201 2RS / C3	BB
12,000	37,000	12,000	6301 2RS / C3	BB
15,000	32,000	9,000	6002 2RS / C3	BB
15,000	35,000	11,000	6202	BB
15,000	35,000	11,000	6202 2RS	BB
15,000	35,000	11,000	6202 2RS / C3	BB
15,000	35,000	11,000	6202 C3	BB
15,000	35,000	11,000	6202 Z	BB
15,000	35,000	11,000	6202 Z / C3	BB
15,000	35,000	11,000	6202 ZZ	BB
15,000	35,000	11,000	6202 ZZ / C3	BB
15,000	35,000	14,000	62202 2RS / C3	BB
15,000	42,000	13,000	6302	BB
15,000	42,000	13,000	6302 2RS	BB
15,000	42,000	13,000	6302 2RS / C3	BB
15,000	42,000	13,000	6302 Z	BB
15,000	42,000	13,000	6302 ZZ / C3	BB
15,000	42,000	14,250	30302 F	TRB
15,875	42,862	14,288	11590 / 11520	TRB
17,000	35,000	10,000	6003 2RS	BB
17,000	35,000	10,000	6003 2RS / C3	BB
17,000	40,000	12,000	6203	BB
17,000	40,000	12,000	6203 2RS	BB
17,000	40,000	12,000	6203 2RS / C3	BB
17,000	40,000	12,000	6203 C3	BB
17,000	40,000	12,000	6203 Z	BB
17,000	40,000	12,000	6203 ZZ	BB
17,000	40,000	12,000	6203 ZZ / C3	BB
17,000	40,000	13,250	30203 F	TRB
17,000	47,000	14,000	6303	BB
17,000	47,000	14,000	6303 2RS	BB
17,000	47,000	14,000	6303 2RS / C3	BB
17,000	47,000	14,000	6303 C3	BB
17,000	47,000	14,000	6303 RS / C3	BB

Dimensions / Dimensões / Dimensiones			Fersa®	
d	D	T		
17,000	47,000	14,000	6303 RSR / C3	BB
17,000	47,000	14,000	6303 Z	BB
17,000	47,000	14,000	6303 Z / C3	BB
17,000	47,000	14,000	6303 ZZ	BB
17,000	47,000	14,000	6303 ZZ / C3	BB
17,000	47,000	14,000	NU 303 FM	CRB
17,000	47,000	14,000	NU 303 FM / C3	CRB
17,000	47,000	14,000	NU 303 FMN	CRB
17,000	47,000	15,250	30303 F	TRB
17,000	62,000	17,000	6403 2RS / C3	BB
17,000	62,000	17,000	6403 C3	BB
17,462	39,878	13,843	LM 11749 / LM 11710	TRB
19,050	39,992	12,014	A 6075 / A 6157	TRB
19,050	45,237	15,494	LM 11949 / LM 11910	TRB
20,000	42,000	12,000	6004	BB
20,000	42,000	12,000	6004 2RS	BB
20,000	42,000	12,000	6004 2RS / C3	BB
20,000	42,000	12,000	6004 Z	BB
20,000	42,000	12,000	6004 ZZ / C3	BB
20,000	47,000	14,000	6204	BB
20,000	47,000	14,000	6204 2RS	BB
20,000	47,000	14,000	6204 2RS / C3	BB
20,000	47,000	14,000	6204 C3	BB
20,000	47,000	14,000	6204 Z	BB
20,000	47,000	14,000	6204 ZZ	BB
20,000	47,000	14,000	6204 ZZ / C3	BB
20,000	47,000	15,250	30204 F	TRB
20,000	47,000	18,000	62204 2RS	BB
20,000	52,000	15,000	6304	BB
20,000	52,000	15,000	6304 2RS	BB
20,000	52,000	15,000	6304 2RS / C3	BB
20,000	52,000	15,000	6304 C3	BB
20,000	52,000	15,000	6304 C4	BB
20,000	52,000	15,000	6304 ZZ	BB
20,000	52,000	15,000	6304 ZZ / C3	BB
20,000	52,000	15,000	NJ 304 FM	CRB
20,000	52,000	15,000	NJ 304 FMN	CRB
20,000	52,000	15,000	NUP 304 FM	CRB
20,000	52,000	16,250	30304 F	TRB
20,000	52,000	22,250	32304 F	TRB
21,430	45,237	15,494	LM 12748 / LM 12710	TRB
21,430	50,005	17,526	M 12649 / M 12610	TRB
21,986	45,237	15,494	LM 12749 / LM 12710	TRB
21,986	45,974	15,494	LM 12749 / LM 12711	TRB
22,225	52,388	19,368	1380 / 1328	TRB
25,000	47,000	12,000	6005	BB
25,000	47,000	12,000	6005 2RS	BB

Dimensions / Dimensões / Dimensiones			Fersa®	
d	D	T		
25,000	47,000	12,000	6005 2RS / C3	BB
25,000	47,000	12,000	6005 ZZ / C3	BB
25,000	52,000	15,000	6205	BB
25,000	52,000	15,000	6205 2RS	BB
25,000	52,000	15,000	6205 2RS / C3	BB
25,000	52,000	15,000	6205 C3	BB
25,000	52,000	15,000	6205 RS	BB
25,000	52,000	15,000	6205 RS / C3	BB
25,000	52,000	15,000	6205 Z	BB
25,000	52,000	15,000	6205 ZZ	BB
25,000	52,000	15,000	6205 ZZ / C3	BB
25,000	52,000	15,000	NJ 205 / C3	CRB
25,000	52,000	16,250	30205 F	TRB
25,000	52,000	18,000	62205 2RS	BB
25,000	52,000	18,000	NU 2205	CRB
25,000	52,000	18,000	NUP 2205	CRB
25,000	52,000	19,250	32205 BF	TRB
25,000	52,000	19,250	32205 F	TRB
25,000	52,000	21,000	F 19029	CRBS
25,000	52,000	22,000	33205 F	TRB
25,000	52,000	37,000	F 15041	TRBDR
25,000	55,000	43,000	F 15043	TRBDR
25,000	55,000	45,000	F 15175	TRBDR
25,000	62,000	17,000	6305	BB
25,000	62,000	17,000	6305 2RS	BB
25,000	62,000	17,000	6305 2RS / C3	BB
25,000	62,000	17,000	6305 C3	BB
25,000	62,000	17,000	6305 ZZ / C3	BB
25,000	62,000	17,000	NJ 305 C3	CRB
25,000	62,000	17,000	NJ 305 FM / C3	CRB
25,000	62,000	18,250	30305 F	TRB
25,000	62,000	25,250	32305 F	TRB
25,000	62,020	24,000	F 18018	BBS
25,000	72,000	19,000	6306 D25 2RS / C3	BB
25,400	50,292	14,224	L 44643 / L 44610	TRB
25,400	57,150	19,431	M 84548 / M 84510	TRB
25,400	62,000	19,050	15101 / 15245	TRB
25,995	68,000	19,700	F 18024	BBS
26,162	61,912	19,050	15103 S / 15243	TRB
26,988	50,292	14,224	L 44649 / L 44610	TRB
26,988	63,500	20,638	15106 / 15250 X	TRB
27,000	52,000	45,0 / 50,0	F 15151	TRBDR
27,000	53,000	43,000	F 15128	TRBDR
28,000	66,000	18,000	F 18021	BBS
28,575	64,292	21,433	M 86647 / M 86610	TRB
28,575	66,421	23,812	2689 / 2631	TRB
28,575	71,438	20,638	RMS 9 2RS / C4	BB
29,000	50,292	14,224	F 15029	TRBS
29,000	50,292	14,224	L 45449 / L 45410	TRB
29,000	53,000	37,000	F 15067	TRBDR
30,000	55,000	13,000	6006	BB
30,000	55,000	13,000	6006 2RS	BB
30,000	55,000	13,000	6006 2RS / C3	BB
30,000	55,000	13,000	6006 RS / C3	BB
30,000	55,000	13,000	6006 ZZ / C3	BB
30,000	55,000	17,000	32006 XF	TRB
30,000	55,000	23,000	F 16098	BBDRAC

Dimensions / Dimensões / Dimensiones			Fersa®	
d	D	T		
30,000	60,000	26,000	F 19019	CRBS
30,000	62,000	16,000	6206	BB
30,000	62,000	16,000	6206 2RS	BB
30,000	62,000	16,000	6206 2RS / C3	BB
30,000	62,000	16,000	6206 2RS / C4	BB
30,000	62,000	16,000	6206 C3	BB
30,000	62,000	16,000	6206 NR	BB
30,000	62,000	16,000	6206 NR 2RS	BB
30,000	62,000	16,000	6206 Z	BB
30,000	62,000	16,000	6206 ZZ	BB
30,000	62,000	16,000	6206 ZZ / C3	BB
30,000	62,000	16,000	NJ 206	CRB
30,000	62,000	16,000	NU 206 FM	CRB
30,000	62,000	16,000	NUP 206 FM	CRB
30,000	62,000	17,250	30206 F	TRB
30,000	62,000	20,000	62206 2RS	BB
30,000	62,000	20,000	NJ 2206 FM	CRB
30,000	62,000	21,250	32206 F	TRB
30,000	62,000	23,800	3206 B	BB2R
30,000	62,000	27,000	F 16104	BBDRAC
30,000	72,000	19,000	6306	BB
30,000	72,000	19,000	6306 2RS	BB
30,000	72,000	19,000	6306 2RS / C3	BB
30,000	72,000	19,000	6306 C3	BB
30,000	72,000	19,000	6306 NR	BB
30,000	72,000	19,000	6306 NR 2RS / C3	BB
30,000	72,000	19,000	6306 ZNR	BB
30,000	72,000	19,000	6306 ZNR / C3	BB
30,000	72,000	19,000	6306 ZZ	BB
30,000	72,000	19,000	6306 ZZ / C3	BB
30,000	72,000	19,000	N 306 F	CRB
30,000	72,000	20,750	30306 F	TRB
30,000	72,000	20,750	31306 F	TRB
30,000	72,000	28,750	32306 F	TRB
30,000	110,000	32,300	F 19075	CRBS
30,000	120,000	63,500	F 16065	BBDRAC
30,000	120,000	68,500	F 16013	BBDRAC
30,162	64,292	21,433	M 86649 / M 86610	TRB
30,162	68,262	22,225	M 88043 / M 88010	TRB
30,226	69,012	19,845	14116 / 14276	TRB
31,750	59,131	15,875	LM 67048 / LM 67010	TRB
31,750	73,025	29,370	HM 88542 / HM 88510	TRB
32,000	53,000	14,500	JL 26749 F / JL 26710	TRB
33,338	68,262	22,225	M 88048 / M 88010	TRB
33,338	69,012	19,845	14131 / 14276	TRB
33,338	72,626	30,162	3196 / 3120	TRB
33,338	76,200	29,369	HM 89443 / HM 89411	TRB
34,000	64,000	37,000	F 16019	BBDRAC
34,000	66,000	37,000	F 16020	BBDRAC
34,000	67,000	37,000	F 16083	BBDRAC
34,925	65,088	18,034	LM 48548 / LM 48510	TRB
34,925	68,262	20,638	14585 / 14525	TRB
34,925	72,233	25,400	HM 88649 / HM 88610	TRB
34,925	73,025	23,812	25877 / 25820	TRB

Dimensions / Dimensões / Dimensiones			Fersa®	
d	D	T		
34,925	73,025	23,812	25877 / 25821	TRB
34,925	76,200	29,370	31594 / 31520	TRB
34,987	59,131	15,875	L 68149 / L 68110	TRB
34,987	59,975	15,875	L 68149 / L 68111	TRB
34,987	61,973	16,702	LM 78349 / LM 78310 A	TRB
34,987	64,975	18,100	U 298 / U 261 L	U Series
34,993	80,000	23,000	F 19043	CRBS
35,000	50,000	20,000	F 16097	BBDRAC
35,000	50,000	20,000	F 16099	BBDRAC
35,000	52,000	22,000	F 16101	BBDRAC
35,000	55,000	20,000	F 16100	BBDRAC
35,000	60,000	15,875	F 15036	TRBS
35,000	62,000	14,000	6007	BB
35,000	62,000	14,000	6007 2RS	BB
35,000	62,000	14,000	6007 2RS / C3	BB
35,000	62,000	14,000	6007 C3	BB
35,000	62,000	14,000	6007 N	BB
35,000	62,000	18,000	32007 XF	TRB
35,000	65,000	35,000	F 15044	TRBDR
35,000	65,000	35,000	F 16021	BBDRAC
35,000	66,000	37,000	F 16023	BBDRAC
35,000	68,000	48,000	F 15173	TRBDR
35,000	72,000	17,000	6207	BB
35,000	72,000	17,000	6207 2RS	BB
35,000	72,000	17,000	6207 2RS / C3	BB
35,000	72,000	17,000	6207 C3	BB
35,000	72,000	17,000	6207 NR	BB
35,000	72,000	17,000	6207 NR 2RS	BB
35,000	72,000	17,000	6207 Z	BB
35,000	72,000	17,000	6207 ZN / C3	BB
35,000	72,000	17,000	6207 ZNR	BB
35,000	72,000	17,000	6207 ZZ	BB
35,000	72,000	17,000	N 207 / C3	CRB
35,000	72,000	18,250	30207 F	TRB
35,000	72,000	24,250	32207 F	TRB
35,000	72,000	27,000	3207 B	BB2R
35,000	72,000	28,000	33207 F	TRB
35,000	72,000	33,000	F 16026	BBDRAC
35,000	80,000	21,000	6307	BB
35,000	80,000	21,000	6307 2RS	BB
35,000	80,000	21,000	6307 2RS / C3	BB
35,000	80,000	21,000	6307 C3	BB
35,000	80,000	21,000	6307 NR	BB
35,000	80,000	21,000	6307 NR 2RS	BB
35,000	80,000	21,000	6307 RS	BB
35,000	80,000	21,000	6307 Z	BB
35,000	80,000	21,000	6307 ZNR	BB
35,000	80,000	21,000	N 307 FM	CRB
35,000	80,000	21,000	NJ 307 F	CRB
35,000	80,000	22,000	F 19020	CRBS
35,000	80,000	22,750	30307 F	TRB
35,000	80,000	23,000	F 19012	CRBS
35,000	80,000	32,750	32307 F	TRB
35,000	100,000	25,000	6407 C3	BB
35,000	136,000	75,000	F 16028	BBDRAC
36,000	56,300	20,000	F 19048	CRBS
36,487	73,025	23,812	25880 / 25820	TRB

Dimensions / Dimensões / Dimensiones			Fersa®	
d	D	T		
36,487	76,200	23,812	2780 / 2720	TRB
36,512	76,200	29,370	31597 / 31520	TRB
36,512	76,200	29,370	HM 89449 / HM 89410	TRB
36,513	68,000	15,000	F 18039	BBS
37,000	72,000	33,000	F 16029	BBDRAC
37,000	72,000	37,000	F 16030	BBDRAC
37,000	74,000	45,000	F 16032	BBDRAC
37,990	74,020	36,000	F 16034	BBDRAC
38,000	63,000	17,000	JL 69349 / JL 69310	TRB
38,000	63,000	17,000	JL 69349 X / JL 69310	TRB
38,000	94,000	33,000	F 19076	CRBS
38,100	65,088	18,034	LM 29749 / LM 29710	TRB
38,100	65,088	19,812	LM 29749 / LM 29711	TRB
38,100	70,000	37,000	F 16057	BBDRAC
39,000	68,000	37,000	F 16035	BBDRAC
39,000	72,000	37,000	F 16036	BBDRAC
39,000	72,000	37,000	F 16110	BBDRAC
39,000	74,000	39,000	F 16037	BBDRAC
39,000	75,000	37,000	F 16038	BBDRAC
39,688	73,025	19,400	U 399 / U 360 L	U Series
39,688	76,200	23,812	2789 / 2720	TRB
39,688	80,167	29,370	3382 / 3320	TRB
39,980	108,000	32,000	F 16044	BBDRAC
40,000	46,000	33,000	F 16198	BBDRAC
40,000	62,000	20,625	F 16103	BBDRAC
40,000	62,000	24,000	F 16102	BBDRAC
40,000	68,000	15,000	6008	BB
40,000	68,000	15,000	6008 2RS	BB
40,000	68,000	15,000	6008 Z	BB
40,000	68,000	19,000	32008 XF	TRB
40,000	72,000	37,000	F 16039	BBDRAC
40,000	74,000	40,000	F 16040	BBDRAC
40,000	75,000	37,000	F 16055	BBDRAC
40,000	80,000	18,000	6208	BB
40,000	80,000	18,000	6208 2RS	BB
40,000	80,000	18,000	6208 2RS / C3	BB
40,000	80,000	18,000	6208 N	BB
40,000	80,000	18,000	6208 ZZ	BB
40,000	80,000	18,000	NU 208 FM	CRB
40,000	80,000	18,000	QJ 208 FM	BB4PAC
40,000	80,000	19,750	30208 F	TRB
40,000	80,000	24,750	32208 F	TRB
40,000	80,000	32,000	33208 F	TRB
40,000	85,000	33,000	JF 4049 / JF 4010	TRB
40,000	90,000	23,000	6308	BB
40,000	90,000	23,000	6308 2RS	BB
40,000	90,000	23,000	6308 N	BB
40,000	90,000	23,000	6308 NR	BB
40,000	90,000	23,000	6308 NR / C4	BB
40,000	90,000	23,000	6308 ZNR	BB
40,000	90,000	23,000	6308 ZNR / C3	BB
40,000	90,000	23,000	F 19034	CRBS
40,000	90,000	23,000	NUP 308 FM	CRB
40,000	90,000	25,000	F 19033	CRBS
40,000	90,000	25,250	30308 F	TRB

Dimensions / Dimensões / Dimensiones			Fersa®	
d	D	T		
40,000	90,000	25,250	31308 F	TRB
40,000	90,000	27,000	F 19013	CRBS
40,000	90,000	35,250	32308 BF	TRB
40,000	90,000	35,250	32308 F	TRB
40,000	110,000	27,000	6408	BB
40,000	110,000	27,000	6408 NR / C3	BB
40,987	67,975	17,500	LM 300849 / LM 300811	TRB
41,275	73,431	19,558	LM 501349 / LM 501310	TRB
41,275	73,431	19,558	LM 501349 / LM 501310	TRB
41,275	73,431	21,430	LM 501349 / LM 501314	TRB
41,275	82,550	26,543	M 802048 / M 802011	TRB
41,275	87,312	30,162	3585 / 3525	TRB
41,275	88,900	30,162	HM 803146 / HM 803110	TRB
41,275	88,900	30,163	HM 803145 / HM 803110	TRB
41,275	104,775	36,512	59162 / 59412	TRB
41,529	72,619	21,433	T 163	TRBT
42,000	76,000	38,000	F 16081	BBDRAC
42,000	76,000	39,000	F 16194	BBDRAC
42,000	76,000	40,000	F 16195	BBDRAC
42,000	76,000	43,000	F 16197	BBDRAC
42,000	80,000	45,000	F 16088	BBDRAC
42,000	82,000	36,000	F 16048	BBDRAC
42,000	84,030	39,000	F 16051	BBDRAC
42,862	76,992	17,464	12168 / 12303	TRB
42,875	82,931	26,988	25577 / 25523	TRB
43,000	76,000	43,000	F 16196	BBDRAC
43,000	79,000	41,000	F 16052	BBDRAC
43,000	82,000	37,000	F 16054	BBDRAC
43,000	82,000	45,000	F 16078	BBDRAC
44,450	76,992	17,464	12175 / 12303	TRB
44,450	82,931	23,812	25580 / 25520	TRB
44,450	82,931	23,813	25581 / 25520	TRB
44,450	88,900	30,162	HM 803149 / HM 803110	TRB
44,450	93,264	30,162	3782 / 3720	TRB
44,450	95,250	27,783	33885 / 33822	TRB
44,450	95,250	30,162	HM 804843 / HM 804810	TRB
44,450	95,250	30,958	53178 / 53377	TRB
44,450	95,250	30,958	HM 903249 / HM 903210	TRB
44,450	104,775	36,512	59175 / 59412	TRB
44,450	104,775	36,512	HM 807040 / HM 807010	TRB
44,987	79,975	24,000	U 497 / U 460 L	U Series
44,987	104,986	32,512	HM 905843 / HM 905810	TRB
45,000	68,000	12,000	61909	BB
45,000	75,000	16,000	6009	BB
45,000	75,000	16,000	6009 2RS	BB
45,000	75,000	16,000	6009 C3	BB
45,000	75,000	16,000	6009 NR	BB
45,000	75,000	16,000	6009 ZZ	BB
45,000	75,000	20,000	32009 XF	TRB
45,000	80,000	26,000	33109 F	TRB
45,000	84,000	39,000	F 16058	BBDRAC
45,000	84,020	39,000	F 16059	BBDRAC

Dimensions / Dimensões / Dimensiones			Fersa®	
d	D	T		
45,000	85,000	19,000	6209	BB
45,000	85,000	19,000	6209 2RS	BB
45,000	85,000	19,000	6209 C3	BB
45,000	85,000	19,000	6209 NR	BB
45,000	85,000	19,000	6209 NR / C3	BB
45,000	85,000	19,000	6209 ZZ	BB
45,000	85,000	19,000	NU 209 FMN	CRB
45,000	85,000	19,000	QJ 209 FM	BB4PAC
45,000	85,000	20,750	30209 F	TRB
45,000	85,000	32,000	33209 F	TRB
45,000	85,000	190,000	NU 209 FMN / C3	CRB
45,000	95,000	32,000	F 19015	CRBS
45,000	95,000	36,000	JF 4549 / JF 4510	TRB
45,000	100,000	25,000	6309	BB
45,000	100,000	25,000	6309 2RS	BB
45,000	100,000	25,000	6309 NR	BB
45,000	100,000	25,000	6309 NR / C3	BB
45,000	100,000	25,000	6309 Z / C3	BB
45,000	100,000	25,000	6309 ZNR / C3	BB
45,000	100,000	25,000	F 19002	CRBS
45,000	100,000	25,000	F 19044	CRBS
45,000	100,000	25,000	N 309 FM	CRB
45,000	100,000	25,000	NJ 309 FM	CRB
45,000	100,000	25,000	NJ 309 C3	CRB
45,000	100,000	25,000	NJ 309 FM	CRB
45,000	100,000	25,000	NJ 309 FM / C3	CRB
45,000	100,000	25,000	NUP 309	CRB
45,000	100,000	25,000	NUP 309 C3	CRB
45,000	100,000	25,000	NUP 309 FM	CRB
45,000	100,000	25,000	NUP 309 FM / C3	CRB
45,000	100,000	25,000	QJ 309 FM	BB4PAC
45,000	100,000	27,250	30309 F	TRB
45,000	100,000	27,250	31309 F	TRB
45,000	100,000	36,000	F 19001	CRBS
45,000	100,000	36,000	NJ 2309 F / C3	CRB
45,000	100,000	38,250	32309 F	TRB
45,000	120,000	29,000	6409	BB
45,000	120,000	29,000	6409 C3	BB
45,000	120,000	29,000	6409 NR / C3	BB
45,000	120,000	84,900	F 300006	CWT
45,230	79,985	19,842	17887 / 17831	TRB
45,237	87,312	30,163	3586 / 3525	TRB
45,242	73,431	19,558	LM 102949 / LM 102910	TRB
45,242	77,788	19,842	LM 603049 / LM 603011	TRB
45,242	77,788	21,430	LM 603049 / LM 603012	TRB
45,618	82,931	23,812	25590 / 25520	TRB
45,618	83,058	23,876	25590 / 25522	TRB
45,987	74,976	18,000	LM 503349 A / LM 503310	TRB
46,279	82,956	23,812	T 182	TRBT
47,000	81,000	53,000	F 16199	BBDRAC
47,625	88,900	25,400	M 804049 / M 804010	TRB
47,625	95,250	30,162	HM 804846 / HM 804810	TRB
47,625	123,825	36,152	72188 C / 72487	TRB
50,000	80,000	16,000	6010	BB

Dimensions / Dimensões / Dimensiones			Fersa®	
d	D	T		
50,000	80,000	16,000	6010 2RS	BB
50,000	80,000	16,000	6010 C3	BB
50,000	80,000	16,000	6010 Z	BB
50,000	80,000	20,000	32010 XF	TRB
50,000	82,000	21,500	JLM 104948 / JLM 104910	TRB
50,000	82,550	23,148	JLM 104946 / JLM 104911 A	TRB
50,000	85,000	26,000	33110 F	TRB
50,000	90,000	20,000	6210	BB
50,000	90,000	20,000	6210 2RS	BB
50,000	90,000	20,000	6210 Z	BB
50,000	90,000	20,000	6210 ZZ	BB
50,000	90,000	20,000	6210 ZZ NR	BB
50,000	90,000	20,000	7210 B	BB
50,000	90,000	20,000	F 18041	BBS
50,000	90,000	21,750	30210 F	TRB
50,000	90,000	24,750	32210 F	TRB
50,000	90,000	28,000	JM 205149 / JM 205110	TRB
50,000	90,000	32,000	33210 F	TRB
50,000	100,000	25,000	F 19046	CRBS
50,000	100,000	36,000	JF 5049 / JF 5010	TRB
50,000	110,000	27,000	6310	BB
50,000	110,000	27,000	6310 2RS	BB
50,000	110,000	27,000	6310 C3	BB
50,000	110,000	27,000	NU 310 FM	CRB
50,000	110,000	27,000	NU 310 FM / C3	CRB
50,000	110,000	27,000	NUP 310 FM / C3	CRB
50,000	110,000	27,000	NUP 310 FMN / C3	CRB
50,000	110,000	42,250	32310 F	TRB
50,800	82,000	21,500	LM 104949 / LM 104910	TRB
50,800	82,550	21,590	LM 104949 / LM 104911	TRB
50,800	82,931	21,590	LM 104949 / LM 104912	TRB
50,800	88,900	20,638	368 A / 362 A	TRB
50,800	90,000	25,000	368 A / 362 X	TRB
50,800	93,264	30,162	3780 / 3720	TRB
50,800	93,264	30,163	3775 / 3720	TRB
50,800	95,250	27,783	33889 / 33822	TRB
50,800	104,775	30,162	45284 / 45220	TRB
50,800	104,775	36,512	HM 807046 / HM 807010	TRB
50,800	104,775	36,512	HM 807046 / HM 807011	TRB
50,800	107,950	36,512	537 / 532 X	TRB
50,800	111,125	30,162	55200 C / 55437	TRB
50,800	123,825	36,512	72200 C / 72487	TRB
51,592	90,000	20,000	368 S / 362	TRB
52,388	111,125	30,162	55206 C / 55437	TRB
53,975	88,900	19,050	LM 806649 / LM 806610	TRB
53,975	95,250	27,783	33895 / 33821	TRB
53,975	95,250	27,783	33895 / 33822	TRB
53,975	104,775	36,512	HM 807049 / HM 807010	TRB
53,975	123,825	36,152	72212 C / 72487	TRB
53,975	140,030	36,513	78215 C / 78551	TRB
55,000	90,000	18,000	6011	BB
55,000	90,000	18,000	6011 C3	BB
55,000	90,000	18,000	6011 ZZ	BB

Dimensions / Dimensões / Dimensiones			Fersa®	
d	D	T		
55,000	90,000	18,000	NU 1011 FM	CRB
55,000	90,000	23,000	32011 XF	TRB
55,000	90,000	23,000	LM 506849 / LM 506810	TRB
55,000	90,000	25,000	JLM 506849 A / JLM 506811	TRB
55,000	90,000	27,000	33011 F	TRB
55,000	91,500	25,000	F 15141	BBS
55,000	95,000	29,000	JM 207049 / JM 207010	TRB
55,000	95,000	29,000	JM 207049 A / JM 207010	TRB
55,000	95,000	30,000	33111 F	TRB
55,000	100,000	21,000	6211	BB
55,000	100,000	21,000	6211 2RS	BB
55,000	100,000	21,000	6211 C3	BB
55,000	100,000	21,000	6211 N / C3	BB
55,000	100,000	21,000	6211 Z	BB
55,000	100,000	21,000	6211 ZNR	BB
55,000	100,000	22,750	30211 F	TRB
55,000	100,000	25,000	N 2211 FMNR / C3	CRB
55,000	100,000	25,000	NJ 2211 FM	CRB
55,000	100,000	26,750	32211 F	TRB
55,000	100,000	35,000	F 15047	TRBS
55,000	120,000	29,000	6311	BB
55,000	120,000	29,000	6311 C3	BB
55,000	120,000	29,000	6311 NR / C3	BB
55,000	120,000	29,000	NUP 311 FM	CRB
55,000	120,000	29,000	NUP 311 FM / C3	CRB
55,000	120,000	29,000	NUP 311 FMNR / C3	CRB
55,000	120,000	31,500	31311 F	TRB
55,000	120,000	45,500	32311 F	TRB
55,562	123,825	36,152	72218 C / 72487	TRB
57,150	96,838	21,000	387 / 382 A	TRB
57,150	96,838	21,000	387 A / 382 A	TRB
57,150	96,838	21,000	387 AS / 382 A	TRB
57,150	96,838	25,400	387 A / 382 S	TRB
57,150	97,630	24,608	28682 / 28622	TRB
57,150	100,000	21,000	387 A / 383 A	TRB
57,150	104,775	30,162	45291 / 45220	TRB
57,150	104,775	30,162	469 / 453 X	TRB
57,150	107,950	27,975	469 / 453	TRB
57,150	112,712	30,162	39580 / 39520	TRB
57,150	112,712	30,162	39581 / 39520	TRB
57,150	117,475	33,338	66225 / 66462	TRB
57,150	123,825	38,100	555 S / 552 A	TRB
57,150	140,030	36,513	78225 C / 78551	TRB
57,531	98,425	21,000	388 A / 382	TRB
58,000	110,000	115,000	F 200003	KWT
60,000	95,000	23,000	32012 XF	TRB
60,000	95,000	24,000	JLM 508748 / JLM 508710	TRB
60,000	96,500	25,700	F 15140	BBS
60,000	96,500	29,700	F 15139	BBS
60,000	100,000	30,000	33112 F	TRB
60,000	110,000	22,000	6212	BB
60,000	110,000	22,000	6212 2RS	BB
60,000	110,000	22,000	6212 NR	BB
60,000	110,000	22,000	6212 ZNR	BB
60,000	110,000	22,000	F 19011	CRBS

Dimensions / Dimensões / Dimensiones			Fersa®	
d	D	T		
60,000	110,000	22,000	NUP 212 FM	CRB
60,000	110,000	22,000	QJ 212 FM	BB4PAC
60,000	110,000	23,750	30212 F	TRB
60,000	110,000	28,000	F 19042	CRBS
60,000	110,000	28,000	NUP 2212 F	CRB
60,000	110,000	28,000	NUP 2212 FMN	CRB
60,000	110,000	29,750	32212 F	TRB
60,000	110,000	38,000	33212 F	TRB
60,000	115,000	40,000	JF 6049 / JF 6010	TRB
60,000	116,000	28,000	F 19047	CRBS
60,000	130,000	31,000	6312 C3	BB
60,000	130,000	31,000	6312 NR / C3	BB
60,000	130,000	31,000	F 19009	CRBS
60,000	130,000	33,500	30312 F	TRB
60,000	130,000	33,500	31312 F	TRB
60,000	130,000	39,000	F 15046	TRBS
60,000	130,000	48,500	32312 F	TRB
60,000	135,000	37,000	F 15158	TRBS
60,325	100,000	25,400	28985 / 28921	TRB
60,325	122,238	38,100	HM 212044 / HM 212011	TRB
60,325	127,000	36,512	HM 813841 / HM 813810	TRB
60,325	127,000	44,450	65237 / 65500	TRB
60,325	130,175	36,512	HM 911245 / HM 911210	TRB
61,912	127,000	36,512	HM 813843 / HM 813810	TRB
61,912	136,525	46,038	H 715334 / H 715311	TRB
61,912	146,050	41,275	H 913842 / H 913810	TRB
63,000	97,450	34,750	F 19016	CRBS
63,500	100,000	23,000	F 18040	BBS
63,500	102,000	20,570	F 18031	BBS
63,500	104,775	21,433	39250 / 39412	TRB
63,500	105,000	23,000	F 15058	TRBS
63,500	112,712	30,162	39585 / 39520	TRB
63,500	112,712	30,162	3982 / 3920	TRB
63,500	122,238	38,100	HM 212047 / HM 212011	TRB
63,500	123,825	38,100	559 / 552 A	TRB
63,500	127,000	36,512	HM 813842 / HM 813810	TRB
65,000	100,000	18,000	6013	BB
65,000	105,000	24,000	JLM 710949 / JLM 710910	TRB
65,000	105,000	24,000	JLM 710949 C / JLM 710910	TRB
65,000	110,000	28,000	JM 511946 / JM 511910	TRB
65,000	110,000	31,000	JD 6549 / JD 6510	TRB
65,000	110,000	34,000	33113 F	TRB
65,000	120,000	23,000	6213 C3	BB
65,000	120,000	24,750	30213 F	TRB
65,000	120,000	32,750	32213 F	TRB
65,000	120,000	39,000	JH 211749 / JH 211710	TRB
65,000	120,000	41,000	33213 F	TRB
65,000	140,000	33,000	6313 C3	BB
65,000	140,000	33,350	F 19010	CRBS
65,000	140,000	36,000	30313 F	TRB
65,000	140,000	36,000	31313 F	TRB
65,000	140,000	51,000	32313 BF	TRB

Dimensions / Dimensões / Dimensiones			Fersa®	
d	D	T		
65,000	140,000	51,000	32313 F	TRB
65,000	145,000	36,000	F 15082	TRBS
65,000	145,000	39,500	F 15083	TRBS
65,000	165,000	36,000	F 15183	TRBS
65,000	165,000	40,000	F 15159	TRBS
66,675	110,000	22,000	395 A / 394 A	TRB
66,675	112,712	30,162	39590 / 39520	TRB
66,675	112,712	30,162	3984 / 3920	TRB
66,675	112,712	30,162	3994 / 3920	TRB
66,675	122,238	38,100	HM 212049 / HM 212011	TRB
66,675	135,755	53,975	6386 / 6320	TRB
66,675	136,525	41,275	641 / 632	TRB
68,000	125,000	115,000	F 200001 A	KWT
68,000	127,000	115,000	F 15097	HWT
68,262	136,525	46,038	H 715343 / H 715311	TRB
68,262	152,400	47,626	H 914841 / H 914811	TRB
68,262	161,925	49,212	9278 / 9220	TRB
69,850	120,000	29,794	33275 / 33472	TRB
69,850	120,000	29,794	482 / 472	TRB
69,850	120,000	32,545	47487 / 47420 A	TRB
69,850	120,650	25,400	29675 / 29630	TRB
69,952	125,052	47,450	34274 / 34492 A	TRB
70,000	110,000	20,000	6014	BB
70,000	110,000	20,000	6014 2RS	BB
70,000	110,000	20,000	6014 2RS / C3	BB
70,000	110,000	20,000	6014 2RS / C4	BB
70,000	110,000	20,000	6014 C3	BB
70,000	110,000	25,000	32014 XF	TRB
70,000	120,000	37,000	33114 F	TRB
70,000	125,000	24,000	6214	BB
70,000	125,000	26,250	30214 F	TRB
70,000	125,000	33,250	32214 F	TRB
70,000	125,000	41,000	33214 F	TRB
70,000	130,000	57,000	F 15051 C	TRBS
70,000	140,000	39,000	JW 7049 / JW 7010	TRB
70,000	150,000	35,000	6314	BB
70,000	150,000	35,000	6314 C3	BB
70,000	150,000	35,000	6314 N / C3	BB
70,000	150,000	35,000	6314 NR / C3	BB
70,000	150,000	35,000	NUP 314 FM	CRB
70,000	150,000	35,000	NUP 314 FM / C3	CRB
70,000	150,000	35,000	NUP 314 FMN / C3	CRB
70,000	150,000	35,000	NUP 314 FMNR	CRB
70,000	150,000	35,000	NUP 314 FMNR / C3	CRB
70,000	150,000	38,000	30314 F	TRB
70,000	150,000	38,000	31314 F	TRB
70,000	150,000	39,800	F 15116	TRBS
70,000	150,000	54,000	32314 BF	TRB
71,438	117,475	30,162	33281 / 33462	TRB
71,438	120,000	32,545	47490 / 47420	TRB
71,438	127,000	36,512	HM 813849 / HM 813810	TRB
71,438	136,525	46,038	H 715345 / H 715311	TRB
73,025	112,712	25,400	29685 / 29620	TRB
73,025	117,475	30,162	33287 / 33462	TRB
73,025	127,000	36,512	567 / 563	TRB
75,000	115,000	20,000	6015 Z	BB

Dimensions / Dimensões / Dimensiones			Fersa®	
d	D	T		
75,000	115,000	25,000	32015 XF	TRB
75,000	115,000	25,000	JLM 714149 / JLM 714110	TRB
75,000	120,000	31,000	JM 714249 / JM 714210	TRB
75,000	125,000	37,000	33115 F	TRB
75,000	130,000	25,000	6215 C3	BB
75,000	130,000	25,000	6215 NR / C3	BB
75,000	130,000	33,250	32215 F	TRB
75,000	130,000	41,000	33215 F	TRB
75,000	160,000	40,000	31315 F	TRB
75,000	160,000	58,000	32315 BF	TRB
75,000	160,000	58,000	32315 F	TRB
75,000	160,000	58,000	F 15071	TRBS
75,000	180,000	63,500	F 15048	TRBS
76,200	127,000	30,162	42688 / 42620	TRB
76,200	136,525	30,163	495 A / 493	TRB
76,200	136,525	30,163	495 AX / 493	TRB
76,200	149,225	53,975	6461 A / 6420	TRB
76,200	161,925	49,212	9285 / 9220	TRB
77,788	121,442	24,608	34306 / 34478	TRB
80,000	125,000	22,000	6016 2RS / C3	BB
80,000	125,000	29,000	32016 XF	TRB
80,000	130,000	37,000	33116 F	TRB
80,000	140,000	26,000	6216 C3	BB
80,000	140,000	28,250	30216 F	TRB
80,000	140,000	33,500	F 19039	CRBS
80,000	140,000	35,250	32216 F	TRB
80,000	140,000	39,250	F 15156	TRBS
80,000	150,000	28,000	F 19008	CRBS
80,000	170,000	61,500	32316 F	TRB
80,962	136,525	30,163	496 / 493	TRB
80,962	139,992	36,513	581 / 572	TRB
82,550	133,350	33,338	47686 / 47620	TRB
82,550	133,350	39,687	HM 516449 / HM 516410	TRB
82,550	139,982	35,250	580 / 572 A	TRB
82,550	139,992	36,512	580 / 572	TRB
82,550	146,050	41,275	663 / 653	TRB
82,550	152,400	41,275	663 / 652	TRB
84,138	133,350	30,163	498 / 492 A	TRB
84,138	133,350	30,163	498 A / 492 A	TRB
84,138	136,525	30,163	498 / 493	TRB
85,000	130,000	22,000	6017 NR	BB
85,000	130,000	29,000	32017 XF	TRB
85,000	130,000	30,000	JM 716649 / JM 716610	TRB
85,000	130,000	36,000	33017 F	TRB
85,000	140,000	41,000	33117 F	TRB
85,000	150,000	30,500	30217 F	TRB
85,026	150,089	44,450	749 / 742	TRB
85,725	133,350	30,163	497 / 492 A	TRB
85,725	136,525	30,163	497 / 493	TRB
85,725	146,050	41,275	665 / 653	TRB
85,725	152,400	41,275	665 / 652	TRB
87,960	148,430	28,575	42346 / 42584	TRB
88,900	148,430	28,575	42350 / 42584	TRB
88,900	152,400	39,688	HM 518445 / HM 518410	TRB



Dimensions / Dimensões / Dimensiones			Fersa®	
d	D	T		
89,974	146,975	40,000	HM 218248 / HM 218210	TRB
90,000	140,000	32,000	32018 XF	TRB
90,000	140,000	39,000	33018 F	TRB
90,000	160,000	30,000	6218 C3	BB
90,000	160,000	42,500	32218 F	TRB
90,488	161,925	47,625	760 / 752	TRB
92,075	146,050	33,338	47890 / 47820	TRB
92,075	150,000	35,992	598 A / 593 X	TRB
92,075	152,400	39,688	598 A / 592 A	TRB
92,075	168,275	41,275	681 A / 672	TRB
93,662	148,430	28,575	42368 / 42584	TRB
93,800	148,000	135,000	F 200002 A	KWT
95,000	135,000	20,000	JL 819349 / JL 819310	TRB
95,000	145,000	32,000	32019 XF	TRB
95,000	145,000	39,000	33019 F	TRB
95,000	170,000	45,500	32219 F	TRB
95,250	152,400	39,688	594 / 592	TRB
95,250	152,400	39,688	594 / 592 A	TRB
95,250	152,400	39,688	594 A / 592 A	TRB
95,250	168,275	41,275	683 / 672	TRB
96,838	148,430	28,575	42381 / 42584	TRB
99,975	156,975	42,000	HM 220149 / HM 220110	TRB
100,000	150,000	32,000	32020 XF	TRB
100,000	150,000	39,000	33020 F	TRB
100,000	155,000	36,000	JM 720249 / JM 720210	TRB
100,000	160,000	41,000	JHM 720249 / JHM 720210	TRB
100,000	165,000	47,000	JF 10049 / JF 10010	TRB
100,000	180,000	37,000	30220 F	TRB
100,000	180,000	49,000	32220 F	TRB
101,600	157,162	36,512	52400 / 52618	TRB
101,600	168,275	41,275	687 / 672	TRB
105,000	160,000	35,000	32021 XF	TRB
105,000	160,000	43,000	33021 F	TRB
105,000	160,000	140,000	F 200004	KWT
107,950	165,100	36,512	56425 / 56650	TRB
109,538	158,700	23,020	F 15165	TRBS
109,538	158,750	23,020	37431 / 37625	TRB
109,538	158,750	23,020	37431 A / 37625	TRB
110,000	170,000	38,000	32022 XF	TRB
110,000	170,000	38,000	F 15076	TRBS
110,000	170,000	47,000	33022 F	TRB
110,000	180,000	47,000	JHM 522649 / JHM 522610	TRB
110,000	200,000	41,000	30222 F	TRB
114,300	177,800	41,275	64450 / 64700	TRB
114,300	180,975	34,925	68450 / 68712	TRB
117,475	180,975	34,925	68462 / 68712	TRB
120,000	170,000	27,000	JP 12049 / JP 12010	TRB
120,000	170,000	27,000	JP 12049 A / JP 12010	TRB
120,000	180,000	38,000	32024 XF	TRB
---	42,800	---	11 BC	TRB

Fersa Kits list

Lista de Kits Fersa

Lista de Kits Fersa

10.3

Fersa®	Type / Tipo / Tipo		
KA 019	KIT	F 15036	F 15036
KA 021	KIT	F 15029	F 15029
KA 038	KIT	L 45449 / L 45410	LM 11949 / LM 11910
KA 040	KIT	L 44649 / L 44610	LM 11749 / LM 11710
KA 069	KIT	L 45449 / L 45410	LM 11749 / LM 11710
KA 075	KIT	L 45449 / L 45410	LM 11749 / LM 11710
KA 273	KIT	LM 501349 / LM 501310	33205 F
KF 145	KIT	F 16029	
KV 164	KIT	F 16010	

American market applications.

Kits and other applications available at www.fersa.com

Aplicações de mercado da América.

Kits e outras aplicações disponíveis no www.fersa.com

Aplicaciones del mercado América.

Resto de Kits y de aplicaciones consultar en www.fersa.com





Type of Bearing Numerical List

Lista Numérica por Tipo de Rolamento

Lista numérica por Tipo de Rodamiento

10.4

Fersa®	Dimensions / Dimensões / Dimensiones			
	d	D	T	
BB				
6000 2RS / C3	10,000	26,000	8,000	BB
6001	12,000	28,000	8,000	BB
6001 2RS / C3	12,000	28,000	8,000	BB
6001 C3	12,000	28,000	8,000	BB
6002 2RS / C3	15,000	32,000	9,000	BB
6003 2RS	17,000	35,000	10,000	BB
6003 2RS / C3	17,000	35,000	10,000	BB
6004	20,000	42,000	12,000	BB
6004 2RS	20,000	42,000	12,000	BB
6004 2RS / C3	20,000	42,000	12,000	BB
6004 Z	20,000	42,000	12,000	BB
6004 ZZ / C3	20,000	42,000	12,000	BB
6005	25,000	47,000	12,000	BB
6005 2RS	25,000	47,000	12,000	BB
6005 2RS / C3	25,000	47,000	12,000	BB
6005 ZZ / C3	25,000	47,000	12,000	BB
6006	30,000	55,000	13,000	BB
6006 2RS	30,000	55,000	13,000	BB
6006 2RS / C3	30,000	55,000	13,000	BB
6006 RS / C3	30,000	55,000	13,000	BB
6006 ZZ / C3	30,000	55,000	13,000	BB
6007	35,000	62,000	14,000	BB
6007 2RS	35,000	62,000	14,000	BB
6007 2RS / C3	35,000	62,000	14,000	BB
6007 C3	35,000	62,000	14,000	BB
6007 N	35,000	62,000	14,000	BB
6008	40,000	68,000	15,000	BB
6008 2RS	40,000	68,000	15,000	BB
6008 Z	40,000	68,000	15,000	BB
6009	45,000	75,000	16,000	BB
6009 2RS	45,000	75,000	16,000	BB
6009 C3	45,000	75,000	16,000	BB
6009 NR	45,000	75,000	16,000	BB
6009 ZZ	45,000	75,000	16,000	BB
6010	50,000	80,000	16,000	BB
6010 2RS	50,000	80,000	16,000	BB
6010 C3	50,000	80,000	16,000	BB
6010 Z	50,000	80,000	16,000	BB
6011	55,000	90,000	18,000	BB
6011 C3	55,000	90,000	18,000	BB
6011 ZZ	55,000	90,000	18,000	BB
6013	65,000	100,000	18,000	BB
6014	70,000	110,000	20,000	BB
6014 2RS	70,000	110,000	20,000	BB
6014 2RS / C3	70,000	110,000	20,000	BB
6014 2RS / C4	70,000	110,000	20,000	BB
6014 C3	70,000	110,000	20,000	BB
6015 Z	75,000	115,000	20,000	BB
6016 2RS / C3	80,000	125,000	22,000	BB
6017 NR	85,000	130,000	22,000	BB
608 2RS / C3	8,000	22,000	7,000	BB
61909	45,000	68,000	12,000	BB
6200 2RS	10,000	30,000	9,000	BB
6200 2RS / C3	10,000	30,000	9,000	BB
6201	12,000	32,000	10,000	BB
6201 2RS	12,000	32,000	10,000	BB
6201 2RS / C3	12,000	32,000	10,000	BB
6201 N 2RS / C3	12,000	32,000	10,000	BB
6201 RS / C3	12,000	32,000	10,000	BB
6201 Z	12,000	32,000	10,000	BB
6201 Z / C3	12,000	32,000	10,000	BB
6201 ZZ	12,000	32,000	10,000	BB
6201 ZZ / C3	12,000	32,000	10,000	BB

Fersa®	Dimensions / Dimensões / Dimensiones			
	d	D	T	
6202	15,000	35,000	11,000	BB
6202 2RS	15,000	35,000	11,000	BB
6202 2RS / C3	15,000	35,000	11,000	BB
6202 C3	15,000	35,000	11,000	BB
6202 Z	15,000	35,000	11,000	BB
6202 Z / C3	15,000	35,000	11,000	BB
6202 ZZ	15,000	35,000	11,000	BB
6202 ZZ / C3	15,000	35,000	11,000	BB
6203	17,000	40,000	12,000	BB
6203 2RS	17,000	40,000	12,000	BB
6203 2RS / C3	17,000	40,000	12,000	BB
6203 C3	17,000	40,000	12,000	BB
6203 Z	17,000	40,000	12,000	BB
6203 ZZ	17,000	40,000	12,000	BB
6203 ZZ / C3	17,000	40,000	12,000	BB
6204	20,000	47,000	14,000	BB
6204 2RS	20,000	47,000	14,000	BB
6204 2RS / C3	20,000	47,000	14,000	BB
6204 C3	20,000	47,000	14,000	BB
6204 Z	20,000	47,000	14,000	BB
6204 ZZ	20,000	47,000	14,000	BB
6204 ZZ / C3	20,000	47,000	14,000	BB
6205	25,000	52,000	15,000	BB
6205 2RS	25,000	52,000	15,000	BB
6205 2RS / C3	25,000	52,000	15,000	BB
6205 C3	25,000	52,000	15,000	BB
6205 RS	25,000	52,000	15,000	BB
6205 RS / C3	25,000	52,000	15,000	BB
6205 Z	25,000	52,000	15,000	BB
6205 ZZ	25,000	52,000	15,000	BB
6205 ZZ / C3	25,000	52,000	15,000	BB
6206	30,000	62,000	16,000	BB
6206 2RS	30,000	62,000	16,000	BB
6206 2RS / C3	30,000	62,000	16,000	BB
6206 2RS / C4	30,000	62,000	16,000	BB
6206 C3	30,000	62,000	16,000	BB
6206 NR	30,000	62,000	16,000	BB
6206 NR 2RS	30,000	62,000	16,000	BB
6206 Z	30,000	62,000	16,000	BB
6206 ZZ	30,000	62,000	16,000	BB
6206 ZZ / C3	30,000	62,000	16,000	BB
6207	35,000	72,000	17,000	BB
6207 2RS	35,000	72,000	17,000	BB
6207 2RS / C3	35,000	72,000	17,000	BB
6207 C3	35,000	72,000	17,000	BB
6207 NR	35,000	72,000	17,000	BB
6207 NR 2RS	35,000	72,000	17,000	BB
6207 Z	35,000	72,000	17,000	BB
6207 ZN / C3	35,000	72,000	17,000	BB
6207 ZNR	35,000	72,000	17,000	BB
6207 ZZ	35,000	72,000	17,000	BB
6208	40,000	80,000	18,000	BB
6208 2RS	40,000	80,000	18,000	BB
6208 2RS / C3	40,000	80,000	18,000	BB
6208 N	40,000	80,000	18,000	BB
6208 ZZ	40,000	80,000	18,000	BB
6209	45,000	85,000	19,000	BB
6209 2RS	45,000	85,000	19,000	BB
6209 C3	45,000	85,000	19,000	BB
6209 NR	45,000	85,000	19,000	BB
6209 NR / C3	45,000	85,000	19,000	BB
6209 ZZ	45,000	85,000	19,000	BB
6210	50,000	90,000	20,000	BB
6210 2RS	50,000	90,000	20,000	BB
6210 Z	50,000	90,000	20,000	BB

TYPE OF BEARINGS NUMERICAL LIST

LISTA NUMÉRICA POR TIPO DE RODAMIENTO

LISTA NUMÉRICA POR TIPO DE RODAMIENTO

Fersa®	Dimensions / Dimensões / Dimensiones			
	d	D	T	
6210 ZZ	50,000	90,000	20,000	BB
6210 ZZ NR	50,000	90,000	20,000	BB
6211	55,000	100,000	21,000	BB
6211 2RS	55,000	100,000	21,000	BB
6211 C3	55,000	100,000	21,000	BB
6211 N / C3	55,000	100,000	21,000	BB
6211 Z	55,000	100,000	21,000	BB
6211 ZNR	55,000	100,000	21,000	BB
6212	60,000	110,000	22,000	BB
6212 2RS	60,000	110,000	22,000	BB
6212 NR	60,000	110,000	22,000	BB
6212 ZNR	60,000	110,000	22,000	BB
6213 C3	65,000	120,000	23,000	BB
6214	70,000	125,000	24,000	BB
6215 C3	75,000	130,000	25,000	BB
6215 NR / C3	75,000	130,000	25,000	BB
6216 C3	80,000	140,000	26,000	BB
6218 C3	90,000	160,000	30,000	BB
62201 2RS / C3	12,000	32,000	14,000	BB
62202 2RS / C3	15,000	35,000	14,000	BB
62204 2RS	20,000	47,000	18,000	BB
62205 2RS	25,000	52,000	18,000	BB
62206 2RS	30,000	62,000	20,000	BB
6300 2RS / C3	10,000	35,000	11,000	BB
6301 2RS / C3	12,000	37,000	12,000	BB
6302	15,000	42,000	13,000	BB
6302 2RS	15,000	42,000	13,000	BB
6302 2RS / C3	15,000	42,000	13,000	BB
6302 Z	15,000	42,000	13,000	BB
6302 ZZ / C3	15,000	42,000	13,000	BB
6303	17,000	47,000	14,000	BB
6303 2RS	17,000	47,000	14,000	BB
6303 2RS / C3	17,000	47,000	14,000	BB
6303 C3	17,000	47,000	14,000	BB
6303 RS / C3	17,000	47,000	14,000	BB
6303 RSR / C3	17,000	47,000	14,000	BB
6303 Z	17,000	47,000	14,000	BB
6303 Z / C3	17,000	47,000	14,000	BB
6303 ZZ	17,000	47,000	14,000	BB
6303 ZZ / C3	17,000	47,000	14,000	BB
6304	20,000	52,000	15,000	BB
6304 2RS	20,000	52,000	15,000	BB
6304 2RS / C3	20,000	52,000	15,000	BB
6304 C3	20,000	52,000	15,000	BB
6304 C4	20,000	52,000	15,000	BB
6304 ZZ	20,000	52,000	15,000	BB
6304 ZZ / C3	20,000	52,000	15,000	BB
6305	25,000	62,000	17,000	BB
6305 2RS	25,000	62,000	17,000	BB
6305 2RS / C3	25,000	62,000	17,000	BB
6305 C3	25,000	62,000	17,000	BB
6305 ZZ / C3	25,000	62,000	17,000	BB
6306	30,000	72,000	19,000	BB
6306 2RS	30,000	72,000	19,000	BB
6306 2RS / C3	30,000	72,000	19,000	BB
6306 C3	30,000	72,000	19,000	BB
6306 D25 2RS / C3	25,000	72,000	19,000	BB
6306 NR	30,000	72,000	19,000	BB
6306 NR 2RS / C3	30,000	72,000	19,000	BB
6306 ZNR	30,000	72,000	19,000	BB
6306 ZNR / C3	30,000	72,000	19,000	BB
6306 ZZ	30,000	72,000	19,000	BB
6306 ZZ / C3	30,000	72,000	19,000	BB
6307	35,000	80,000	21,000	BB
6307 2RS	35,000	80,000	21,000	BB
6307 2RS / C3	35,000	80,000	21,000	BB
6307 C3	35,000	80,000	21,000	BB
6307 NR	35,000	80,000	21,000	BB
6307 NR 2RS	35,000	80,000	21,000	BB
6307 RS	35,000	80,000	21,000	BB
6307 Z	35,000	80,000	21,000	BB
6307 ZNR	35,000	80,000	21,000	BB
6308	40,000	90,000	23,000	BB

Fersa®	Dimensions / Dimensões / Dimensiones			
	d	D	T	
6308 2RS	40,000	90,000	23,000	BB
6308 N	40,000	90,000	23,000	BB
6308 NR	40,000	90,000	23,000	BB
6308 NR / C4	40,000	90,000	23,000	BB
6308 ZNR	40,000	90,000	23,000	BB
6308 ZNR / C3	40,000	90,000	23,000	BB
6309	45,000	100,000	25,000	BB
6309 2RS	45,000	100,000	25,000	BB
6309 NR	45,000	100,000	25,000	BB
6309 NR / C3	45,000	100,000	25,000	BB
6309 Z / C3	45,000	100,000	25,000	BB
6309 ZNR / C3	45,000	100,000	25,000	BB
6310	50,000	110,000	27,000	BB
6310 2RS	50,000	110,000	27,000	BB
6310 C3	50,000	110,000	27,000	BB
6311	55,000	120,000	29,000	BB
6311 C3	55,000	120,000	29,000	BB
6311 NR / C3	55,000	120,000	29,000	BB
6312 C3	60,000	130,000	31,000	BB
6312 NR / C3	60,000	130,000	31,000	BB
6313 C3	65,000	140,000	33,000	BB
6314	70,000	150,000	35,000	BB
6314 C3	70,000	150,000	35,000	BB
6314 N / C3	70,000	150,000	35,000	BB
6314 NR / C3	70,000	150,000	35,000	BB
6403 2RS / C3	17,000	62,000	17,000	BB
6403 C3	17,000	62,000	17,000	BB
6407 C3	35,000	100,000	25,000	BB
6408	40,000	110,000	27,000	BB
6408 NR / C3	40,000	110,000	27,000	BB
6409	45,000	120,000	29,000	BB
6409 C3	45,000	120,000	29,000	BB
6409 NR / C3	45,000	120,000	29,000	BB
7210 B	50,000	90,000	20,000	BB
RMS 9 2RS / C4	28,575	71,438	20,638	BB

BB2R				
3206 B	30,000	62,000	23,800	BB2R
3207 B	35,000	72,000	27,000	BB2R

BB4PAC				
QJ 208 FM	40,000	80,000	18,000	BB4PAC
QJ 209 FM	45,000	85,000	19,000	BB4PAC
QJ 212 FM	60,000	110,000	22,000	BB4PAC
QJ 309 FM	45,000	100,000	25,000	BB4PAC

BBDRAC				
F 16013	30,000	120,000	68,500	BBDRAC
F 16019	34,000	64,000	37,000	BBDRAC
F 16020	34,000	66,000	37,000	BBDRAC
F 16021	35,000	65,000	35,000	BBDRAC
F 16023	35,000	66,000	37,000	BBDRAC
F 16026	35,000	72,000	33,000	BBDRAC
F 16028	35,000	136,000	75,000	BBDRAC
F 16029	37,000	72,000	33,000	BBDRAC
F 16030	37,000	72,000	37,000	BBDRAC
F 16032	37,000	74,000	45,000	BBDRAC
F 16034	37,990	74,020	36,000	BBDRAC
F 16035	39,000	68,000	37,000	BBDRAC
F 16036	39,000	72,000	37,000	BBDRAC
F 16037	39,000	74,000	39,000	BBDRAC
F 16038	39,000	75,000	37,000	BBDRAC
F 16039	40,000	72,000	37,000	BBDRAC
F 16040	40,000	74,000	40,000	BBDRAC
F 16044	39,980	108,000	32,000	BBDRAC
F 16048	42,000	82,000	36,000	BBDRAC
F 16051	42,000	84,030	39,000	BBDRAC
F 16052	43,000	79,000	41,000	BBDRAC
F 16054	43,000	82,000	37,000	BBDRAC
F 16055	40,000	75,000	37,000	BBDRAC
F 16057	38,100	70,000	37,000	BBDRAC
F 16058	45,000	84,000	39,000	BBDRAC
F 16059	45,000	84,020	39,000	BBDRAC

Fersa®	Dimensions / Dimensões / Dimensiones			
	d	D	T	
F 16065	30,000	120,000	63,500	BBD Racetrack
F 16078	43,000	82,000	45,000	BBD Racetrack
F 16081	42,000	76,000	38,000	BBD Racetrack
F 16083	34,000	67,000	37,000	BBD Racetrack
F 16088	42,000	80,000	45,000	BBD Racetrack
F 16097	35,000	50,000	20,000	BBD Racetrack
F 16098	30,000	55,000	23,000	BBD Racetrack
F 16099	35,000	50,000	20,000	BBD Racetrack
F 16100	35,000	55,000	20,000	BBD Racetrack
F 16101	35,000	52,000	22,000	BBD Racetrack
F 16102	40,000	62,000	24,000	BBD Racetrack
F 16103	40,000	62,000	20,625	BBD Racetrack
F 16104	30,000	62,000	27,000	BBD Racetrack
F 16110	39,000	72,000	37,000	BBD Racetrack
F 16194	42,000	76,000	39,000	BBD Racetrack
F 16195	42,000	76,000	40,000	BBD Racetrack
F 16196	43,000	76,000	43,000	BBD Racetrack
F 16197	42,000	76,000	43,000	BBD Racetrack
F 16198	40,000	46,000	33,000	BBD Racetrack
F 16199	47,000	81,000	53,000	BBD Racetrack

BBS				
F 15139	60,000	96,500	29,700	BBS
F 15140	60,000	96,500	25,700	BBS
F 15141	55,000	91,500	25,000	BBS
F 18018	25,000	62,020	24,000	BBS
F 18021	28,000	66,000	18,000	BBS
F 18024	25,995	68,000	19,700	BBS
F 18031	63,500	102,000	20,570	BBS
F 18039	36,513	68,000	15,000	BBS
F 18040	63,500	100,000	23,000	BBS
F 18041	50,000	90,000	20,000	BBS

CRB				
N 207 / C3	35,000	72,000	17,000	CRB
N 2211 FMNR / C3	55,000	100,000	25,000	CRB
N 306 F	30,000	72,000	19,000	CRB
N 307 FM	35,000	80,000	21,000	CRB
N 309 FM	45,000	100,000	25,000	CRB
NJ 205 / C3	25,000	52,000	15,000	CRB
NJ 206	30,000	62,000	16,000	CRB
NJ 2206 FM	30,000	62,000	20,000	CRB
NJ 2211 FM	55,000	100,000	25,000	CRB
NJ 2309 F / C3	45,000	100,000	36,000	CRB
NJ 304 FM	20,000	52,000	15,000	CRB
NJ 304 FMN	20,000	52,000	15,000	CRB
NJ 305 C3	25,000	62,000	17,000	CRB
NJ 305 FM / C3	25,000	62,000	17,000	CRB
NJ 307 FM	35,000	80,000	21,000	CRB
NJ 309 FM	45,000	100,000	25,000	CRB
NJ 309 C3	45,000	100,000	25,000	CRB
NJ 309 FM	45,000	100,000	25,000	CRB
NJ 309 FM / C3	45,000	100,000	25,000	CRB
NU 1011 FM	55,000	90,000	18,000	CRB
NU 206 FM	30,000	62,000	16,000	CRB
NU 208 FM	40,000	80,000	18,000	CRB
NU 209 FMN	45,000	85,000	19,000	CRB
NU 209 FMN / C3	45,000	85,000	190,000	CRB
NU 2205	25,000	52,000	18,000	CRB
NU 303 FM	17,000	47,000	14,000	CRB
NU 303 FM / C3	17,000	47,000	14,000	CRB
NU 303 FMN	17,000	47,000	14,000	CRB
NU 310 FM	50,000	110,000	27,000	CRB
NU 310 FM / C3	50,000	110,000	27,000	CRB
NUP 206 FM	30,000	62,000	16,000	CRB
NUP 212 FM	60,000	110,000	22,000	CRB
NUP 2205	25,000	52,000	18,000	CRB
NUP 2212 F	60,000	110,000	28,000	CRB
NUP 2212 FMN	60,000	110,000	28,000	CRB
NUP 304 FM	20,000	52,000	15,000	CRB
NUP 308 FM	40,000	90,000	23,000	CRB
NUP 309	45,000	100,000	25,000	CRB
NUP 309 C3	45,000	100,000	25,000	CRB

Fersa®	Dimensions / Dimensões / Dimensiones			
	d	D	T	
NUP 309 FM	45,000	100,000	25,000	CRB
NUP 309 FM / C3	45,000	100,000	25,000	CRB
NUP 310 FM / C3	50,000	110,000	27,000	CRB
NUP 310 FMN / C3	50,000	110,000	27,000	CRB
NUP 311 FM	55,000	120,000	29,000	CRB
NUP 311 FM / C3	55,000	120,000	29,000	CRB
NUP 311 FMNR / C3	55,000	120,000	29,000	CRB
NUP 314 FM	70,000	150,000	35,000	CRB
NUP 314 FM / C3	70,000	150,000	35,000	CRB
NUP 314 FMN / C3	70,000	150,000	35,000	CRB
NUP 314 FMNR / C3	70,000	150,000	35,000	CRB

CRBS				
F 19001	45,000	100,000	36,000	CRBS
F 19002	45,000	100,000	25,000	CRBS
F 19008	80,000	150,000	28,000	CRBS
F 19009	60,000	130,000	31,000	CRBS
F 19010	65,000	140,000	33,350	CRBS
F 19011	60,000	110,000	22,000	CRBS
F 19012	35,000	80,000	23,000	CRBS
F 19013	40,000	90,000	27,000	CRBS
F 19015	45,000	95,000	32,000	CRBS
F 19016	63,000	97,450	34,750	CRBS
F 19019	30,000	60,000	26,000	CRBS
F 19020	35,000	80,000	22,000	CRBS
F 19029	25,000	52,000	21,000	CRBS
F 19033	40,000	90,000	25,000	CRBS
F 19034	40,000	90,000	23,000	CRBS
F 19039	80,000	140,000	33,500	CRBS
F 19042	60,000	110,000	28,000	CRBS
F 19043	34,993	80,000	23,000	CRBS
F 19044	45,000	100,000	25,000	CRBS
F 19046	50,000	100,000	25,000	CRBS
F 19047	60,000	116,000	28,000	CRBS
F 19048	36,000	56,300	20,000	CRBS
F 19075	30,000	110,000	32,300	CRBS
F 19076	38,000	94,000	33,000	CRBS

CWT				
F 300006	45,000	120,000	84,900	CWT

HWT				
F 15097	68,000	127,000	115,000	HWT

KWT				
F 200001 A	68,000	125,000	115,000	KWT
F 200002 A	93,800	148,000	135,000	KWT
F 200003	58,000	110,000	115,000	KWT
F 200004	105,000	160,000	140,000	KWT

TRB				
11 BC	---	42,800	---	TRB
11590 / 11520	15,875	42,862	14,288	TRB
12168 / 12303	42,862	76,992	17,464	TRB
12175 / 12303	44,450	76,992	17,464	TRB
1380 / 1328	22,225	52,388	19,368	TRB
14116 / 14276	30,226	69,012	19,845	TRB
14131 / 14276	33,338	69,012	19,845	TRB
14585 / 14525	34,925	68,262	20,638	TRB
15101 / 15245	25,400	62,000	19,050	TRB
15103 S / 15243	26,162	61,912	19,050	TRB
15106 / 15250 X	26,988	63,500	20,638	TRB
17887 / 17831	45,230	79,985	19,842	TRB
25577 / 25523	42,875	82,931	26,988	TRB
25580 / 25520	44,450	82,931	23,812	TRB
25581 / 25520	44,450	82,931	23,813	TRB
25590 / 25520	45,618	82,931	23,812	TRB
25590 / 25522	45,618	83,058	23,876	TRB
25877 / 25820	34,925	73,025	23,812	TRB
25877 / 25821	34,925	73,025	23,812	TRB
25880 / 25820	36,487	73,025	23,812	TRB
2689 / 2631	28,575	66,421	23,812	TRB

TYPE OF BEARINGS NUMERICAL LIST

LISTA NUMÉRICA POR TIPO DE RODAMIENTO

LISTA NUMÉRICA POR TIPO DE RODAMIENTO

Fersa®	Dimensions / Dimensões / Dimensiones			
	d	D	T	
2780 / 2720	36,487	76,200	23,812	TRB
2789 / 2720	39,688	76,200	23,812	TRB
28682 / 28622	57,150	97,630	24,608	TRB
28985 / 28921	60,325	100,000	25,400	TRB
29675 / 29630	69,850	120,650	25,400	TRB
29685 / 29620	73,025	112,712	25,400	TRB
30203 F	17,000	40,000	13,250	TRB
30204 F	20,000	47,000	15,250	TRB
30205 F	25,000	52,000	16,250	TRB
30206 F	30,000	62,000	17,250	TRB
30207 F	35,000	72,000	18,250	TRB
30208 F	40,000	80,000	19,750	TRB
30209 F	45,000	85,000	20,750	TRB
30210 F	50,000	90,000	21,750	TRB
30211 F	55,000	100,000	22,750	TRB
30212 F	60,000	110,000	23,750	TRB
30213 F	65,000	120,000	24,750	TRB
30214 F	70,000	125,000	26,250	TRB
30216 F	80,000	140,000	28,250	TRB
30217 F	85,000	150,000	30,500	TRB
30220 F	100,000	180,000	37,000	TRB
30222 F	110,000	200,000	41,000	TRB
30302 F	15,000	42,000	14,250	TRB
30303 F	17,000	47,000	15,250	TRB
30304 F	20,000	52,000	16,250	TRB
30305 F	25,000	62,000	18,250	TRB
30306 F	30,000	72,000	20,750	TRB
30307 F	35,000	80,000	22,750	TRB
30308 F	40,000	90,000	25,250	TRB
30309 F	45,000	100,000	27,250	TRB
30312 F	60,000	130,000	33,500	TRB
30313 F	65,000	140,000	36,000	TRB
30314 F	70,000	150,000	38,000	TRB
31306 F	30,000	72,000	20,750	TRB
31308 F	40,000	90,000	25,250	TRB
31309 F	45,000	100,000	27,250	TRB
31311 F	55,000	120,000	31,500	TRB
31312 F	60,000	130,000	33,500	TRB
31313 F	65,000	140,000	36,000	TRB
31314 F	70,000	150,000	38,000	TRB
31315 F	75,000	160,000	40,000	TRB
31594 / 31520	34,925	76,200	29,370	TRB
31597 / 31520	36,512	76,200	29,370	TRB
3196 / 3120	33,338	72,626	30,162	TRB
32006 XF	30,000	55,000	17,000	TRB
32007 XF	35,000	62,000	18,000	TRB
32008 XF	40,000	68,000	19,000	TRB
32009 XF	45,000	75,000	20,000	TRB
32010 XF	50,000	80,000	20,000	TRB
32011 XF	55,000	90,000	23,000	TRB
32012 XF	60,000	95,000	23,000	TRB
32014 XF	70,000	110,000	25,000	TRB
32015 XF	75,000	115,000	25,000	TRB
32016 XF	80,000	125,000	29,000	TRB
32017 XF	85,000	130,000	29,000	TRB
32018 XF	90,000	140,000	32,000	TRB
32019 XF	95,000	145,000	32,000	TRB
32020 XF	100,000	150,000	32,000	TRB
32021 XF	105,000	160,000	35,000	TRB
32022 XF	110,000	170,000	38,000	TRB
32024 XF	120,000	180,000	38,000	TRB
32205 BF	25,000	52,000	19,250	TRB
32205 F	25,000	52,000	19,250	TRB
32206 F	30,000	62,000	21,250	TRB
32207 F	35,000	72,000	24,250	TRB
32208 F	40,000	80,000	24,750	TRB
32210 F	50,000	90,000	24,750	TRB
32211 F	55,000	100,000	26,750	TRB
32212 F	60,000	110,000	29,750	TRB
32213 F	65,000	120,000	32,750	TRB
32214 F	70,000	125,000	33,250	TRB
32215 F	75,000	130,000	33,250	TRB
32216 F	80,000	140,000	35,250	TRB

Fersa®	Dimensions / Dimensões / Dimensiones			
	d	D	T	
32218 F	90,000	160,000	42,500	TRB
32219 F	95,000	170,000	45,500	TRB
32220 F	100,000	180,000	49,000	TRB
32304 F	20,000	52,000	22,250	TRB
32305 F	25,000	62,000	25,250	TRB
32306 F	30,000	72,000	28,750	TRB
32307 F	35,000	80,000	32,750	TRB
32308 BF	40,000	90,000	35,250	TRB
32308 F	40,000	90,000	35,250	TRB
32309 F	45,000	100,000	38,250	TRB
32310 F	50,000	110,000	42,250	TRB
32311 F	55,000	120,000	45,500	TRB
32312 F	60,000	130,000	48,500	TRB
32313 BF	65,000	140,000	51,000	TRB
32313 F	65,000	140,000	51,000	TRB
32314 BF	70,000	150,000	54,000	TRB
32315 BF	75,000	160,000	58,000	TRB
32315 F	75,000	160,000	58,000	TRB
32316 F	80,000	170,000	61,500	TRB
33011 F	55,000	90,000	27,000	TRB
33017 F	85,000	130,000	36,000	TRB
33018 F	90,000	140,000	39,000	TRB
33019 F	95,000	145,000	39,000	TRB
33020 F	100,000	150,000	39,000	TRB
33021 F	105,000	160,000	43,000	TRB
33022 F	110,000	170,000	47,000	TRB
33109 F	45,000	80,000	26,000	TRB
33110 F	50,000	85,000	26,000	TRB
33111 F	55,000	95,000	30,000	TRB
33112 F	60,000	100,000	30,000	TRB
33113 F	65,000	110,000	34,000	TRB
33114 F	70,000	120,000	37,000	TRB
33115 F	75,000	125,000	37,000	TRB
33116 F	80,000	130,000	37,000	TRB
33117 F	85,000	140,000	41,000	TRB
33205 F	25,000	52,000	22,000	TRB
33207 F	35,000	72,000	28,000	TRB
33208 F	40,000	80,000	32,000	TRB
33209 F	45,000	85,000	32,000	TRB
33210 F	50,000	90,000	32,000	TRB
33212 F	60,000	110,000	38,000	TRB
33213 F	65,000	120,000	41,000	TRB
33214 F	70,000	125,000	41,000	TRB
33215 F	75,000	130,000	41,000	TRB
33275 / 33472	69,850	120,000	29,794	TRB
33281 / 33462	71,438	117,475	30,162	TRB
33287 / 33462	73,025	117,475	30,162	TRB
3382 / 3320	39,688	80,167	29,370	TRB
33885 / 33822	44,450	95,250	27,783	TRB
33889 / 33822	50,800	95,250	27,783	TRB
33895 / 33821	53,975	95,250	27,783	TRB
33895 / 33822	53,975	95,250	27,783	TRB
34274 / 34492 A	69,952	125,052	47,450	TRB
34306 / 34478	77,788	121,442	24,608	TRB
3585 / 3525	41,275	87,312	30,162	TRB
3586 / 3525	45,237	87,312	30,163	TRB
368 A / 362 A	50,800	88,900	20,638	TRB
368 A / 362 X	50,800	90,000	25,000	TRB
368 S / 362	51,592	90,000	20,000	TRB
37431 / 37625	109,538	158,750	23,020	TRB
37431 A / 37625	109,538	158,750	23,020	TRB
3775 / 3720	50,800	93,264	30,163	TRB
3780 / 3720	50,800	93,264	30,162	TRB
3782 / 3720	44,450	93,264	30,162	TRB
387 / 382 A	57,150	96,838	21,000	TRB
387 A / 382 A	57,150	96,838	21,000	TRB
387 A / 382 S	57,150	96,838	25,400	TRB
387 A / 383 A	57,150	100,000	21,000	TRB
387 AS / 382 A	57,150	96,838	21,000	TRB
388 A / 382	57,531	98,425	21,000	TRB
39250 / 39412	63,500	104,775	21,433	TRB
395 A / 394 A	66,675	110,000	22,000	TRB
39580 / 39520	57,150	112,712	30,162	TRB

Fersa®	Dimensions / Dimensões / Dimensiones			
	d	D	T	
39581 / 39520	57,150	112,712	30,162	TRB
39585 / 39520	63,500	112,712	30,162	TRB
39590 / 39520	66,675	112,712	30,162	TRB
3982 / 3920	63,500	112,712	30,162	TRB
3984 / 3920	66,675	112,712	30,162	TRB
3994 / 3920	66,675	112,712	30,162	TRB
42346 / 42584	87,960	148,430	28,575	TRB
42350 / 42584	88,900	148,430	28,575	TRB
42368 / 42584	93,662	148,430	28,575	TRB
42381 / 42584	96,838	148,430	28,575	TRB
42688 / 42620	76,200	127,000	30,162	TRB
45284 / 45220	50,800	104,775	30,162	TRB
45291 / 45220	57,150	104,775	30,162	TRB
469 / 453	57,150	107,950	27,975	TRB
469 / 453 X	57,150	104,775	30,162	TRB
47487 / 47420 A	69,850	120,000	32,545	TRB
47490 / 47420	71,438	120,000	32,545	TRB
47686 / 47620	82,550	133,350	33,338	TRB
47890 / 47820	92,075	146,050	33,338	TRB
482 / 472	69,850	120,000	29,794	TRB
495 A / 493	76,200	136,525	30,163	TRB
495 AX / 493	76,200	136,525	30,163	TRB
496 / 493	80,962	136,525	30,163	TRB
497 / 492 A	85,725	133,350	30,163	TRB
497 / 493	85,725	136,525	30,163	TRB
498 / 492 A	84,138	133,350	30,163	TRB
498 A / 492 A	84,138	133,350	30,163	TRB
498 / 493	84,138	136,525	30,163	TRB
52400 / 52618	101,600	157,162	36,512	TRB
53178 / 53377	44,450	95,250	30,958	TRB
537 / 532 X	50,800	107,950	36,512	TRB
55200 C / 55437	50,800	111,125	30,162	TRB
55206 C / 55437	52,388	111,125	30,162	TRB
555 S / 552 A	57,150	123,825	38,100	TRB
559 / 552 A	63,500	123,825	38,100	TRB
56425 / 56650	107,950	165,100	36,512	TRB
567 / 563	73,025	127,000	36,512	TRB
580 / 572	82,550	139,992	36,512	TRB
580 / 572 A	82,550	139,992	35,250	TRB
581 / 572	80,962	139,992	36,513	TRB
59162 / 59412	41,275	104,775	36,512	TRB
59175 / 59412	44,450	104,775	36,512	TRB
594 / 592	95,250	152,400	39,688	TRB
594 / 592 A	95,250	152,400	39,688	TRB
594 A / 592 A	95,250	152,400	39,688	TRB
598 A / 592 A	92,075	152,400	39,688	TRB
598 A / 593 X	92,075	150,000	35,992	TRB
6386 / 6320	66,675	135,755	53,975	TRB
641 / 632	66,675	136,525	41,275	TRB
64450 / 64700	114,300	177,800	41,275	TRB
6461 A / 6420	76,200	149,225	53,975	TRB
65237 / 65500	60,325	127,000	44,450	TRB
66225 / 66462	57,150	117,475	33,338	TRB
663 / 652	82,550	152,400	41,275	TRB
663 / 653	82,550	146,050	41,275	TRB
665 / 652	85,725	152,400	41,275	TRB
665 / 653	85,725	146,050	41,275	TRB
681 A / 672	92,075	168,275	41,275	TRB
683 / 672	95,250	168,275	41,275	TRB
68450 / 68712	114,300	180,975	34,925	TRB
68462 / 68712	117,475	180,975	34,925	TRB
687 / 672	101,600	168,275	41,275	TRB
72188 C / 72487	47,625	123,825	36,152	TRB
72200 C / 72487	50,800	123,825	36,512	TRB
72212 C / 72487	53,975	123,825	36,152	TRB
72218 C / 72487	55,562	123,825	36,152	TRB
749 / 742	85,026	150,089	44,450	TRB
760 / 752	90,488	161,925	47,625	TRB
78215 C / 78551	53,975	140,030	36,513	TRB
78225 C / 78551	57,150	140,030	36,513	TRB
9278 / 9220	68,262	161,925	49,212	TRB
9285 / 9220	76,200	161,925	49,212	TRB
A 6075 / A 6157	19,050	39,992	12,014	TRB

Fersa®	Dimensions / Dimensões / Dimensiones			
	d	D	T	
H 715334 / H 715311	61,912	136,525	46,038	TRB
H 715343 / H 715311	68,262	136,525	46,038	TRB
H 715345 / H 715311	71,438	136,525	46,038	TRB
H 913842 / H 913810	61,912	146,050	41,275	TRB
H 914841 / H 914811	68,262	152,400	47,626	TRB
HM 212044 / HM 212011	60,325	122,238	38,100	TRB
HM 212047 / HM 212011	63,500	122,238	38,100	TRB
HM 212049 / HM 212011	66,675	122,238	38,100	TRB
HM 218248 / HM 218210	89,974	146,975	40,000	TRB
HM 220149 / HM 220110	99,975	156,975	42,000	TRB
HM 516449 / HM 516410	82,550	133,350	39,687	TRB
HM 518445 / HM 518410	88,900	152,400	39,688	TRB
HM 803145 / HM 803110	41,275	88,900	30,163	TRB
HM 803146 / HM 803110	41,275	88,900	30,162	TRB
HM 803149 / HM 803110	44,450	88,900	30,162	TRB
HM 804843 / HM 804810	44,450	95,250	30,162	TRB
HM 804846 / HM 804810	47,625	95,250	30,162	TRB
HM 807040 / HM 807010	44,450	104,775	36,512	TRB
HM 807046 / HM 807010	50,800	104,775	36,512	TRB
HM 807046 / HM 807011	50,800	104,775	36,512	TRB
HM 807049 / HM 807010	53,975	104,775	36,512	TRB
HM 813841 / HM 813810	60,325	127,000	36,512	TRB
HM 813842 / HM 813810	63,500	127,000	36,512	TRB
HM 813843 / HM 813810	61,912	127,000	36,512	TRB
HM 813849 / HM 813810	71,438	127,000	36,512	TRB
HM 88542 / HM 88510	31,750	73,025	29,370	TRB
HM 88649 / HM 88610	34,925	72,233	25,400	TRB
HM 89443 / HM 89411	33,338	76,200	29,369	TRB
HM 89449 / HM 89410	36,512	76,200	29,370	TRB
HM 903249 / HM 903210	44,450	95,250	30,958	TRB
HM 905843 / HM 905810	44,987	104,986	32,512	TRB
HM 911245 / HM 911210	60,325	130,175	36,512	TRB
JD 6549 / JD 6510	65,000	110,000	31,000	TRB
JF 10049 / JF 10010	100,000	165,000	47,000	TRB
JF 4049 / JF 4010	40,000	85,000	33,000	TRB
JF 4549 / JF 4510	45,000	95,000	36,000	TRB
JF 5049 / JF 5010	50,000	100,000	36,000	TRB
JF 6049 / JF 6010	60,000	115,000	40,000	TRB
JH 211749 / JH 211710	65,000	120,000	39,000	TRB
JHM 522649 / JHM 522610	110,000	180,000	47,000	TRB
JHM 720249 / JHM 720210	100,000	160,000	41,000	TRB
JL 26749 F / JL 26710	32,000	53,000	14,500	TRB
JL 69349 / JL 69310	38,000	63,000	17,000	TRB
JL 69349 X / JL 69310	38,000	63,000	17,000	TRB
JL 819349 / JL 819310	95,000	135,000	20,000	TRB
JLM 104946 / JLM 104911 A	50,000	82,550	23,148	TRB
JLM 104948 / JLM 104910	50,000	82,000	21,500	TRB
JLM 506849 A / JLM 506811	55,000	90,000	25,000	TRB
JLM 508748 / JLM 508710	60,000	95,000	24,000	TRB
JLM 710949 / JLM 710910	65,000	105,000	24,000	TRB
JLM 710949 C / JLM 710910	65,000	105,000	24,000	TRB
JLM 714149 / JLM 714110	75,000	115,000	25,000	TRB
JM 205149 / JM 205110	50,000	90,000	28,000	TRB
JM 207049 / JM 207010	55,000	95,000	29,000	TRB
JM 207049 A / JM 207010	55,000	95,000	29,000	TRB
JM 511946 / JM 511910	65,000	110,000	28,000	TRB
JM 714249 / JM 714210	75,000	120,000	31,000	TRB
JM 716649 / JM 716610	85,000	130,000	30,000	TRB
JM 720249 / JM 720210	100,000	155,000	36,000	TRB
JP 12049 / JP 12010	120,000	170,000	27,000	TRB
JP 12049 A / JP 12010	120,000	170,000	27,000	TRB
JW 7049 / JW 7010	70,000	140,000	39,000	TRB
L 44643 / L 44610	25,400	50,292	14,224	TRB
L 44649 / L 44610	26,988	50,292	14,224	TRB
L 45449 / L 45410	29,000	50,292	14,224	TRB
L 68149 / L 68110	34,987	59,131	15,875	TRB
L 68149 / L 68111	34,987	59,975	15,875	TRB
LM 102949 / LM 102910	45,242	73,431	19,558	TRB
LM 104949 / LM 104910	50,800	82,000	21,500	TRB
LM 104949 / LM 104911	50,800	82,550	21,590	TRB
LM 104949 / LM 104912	50,800	82,931	21,590	TRB
LM 11749 / LM 11710	17,462	39,878	13,843	TRB
LM 11949 / LM 11910	19,050	45,237	15,494	TRB

TYPE OF BEARINGS NUMERICAL LIST

LISTA NUMÉRICA POR TIPO DE RODAMIENTO

LISTA NUMÉRICA POR TIPO DE RODAMIENTO

Fersa®	Dimensions / Dimensões / Dimensiones			
	d	D	T	
LM 12748 / LM 12710	21,430	45,237	15,494	TRB
LM 12749 / LM 12710	21,986	45,237	15,494	TRB
LM 12749 / LM 12711	21,986	45,974	15,494	TRB
LM 29749 / LM 29710	38,100	65,088	18,034	TRB
LM 29749 / LM 29711	38,100	65,088	19,812	TRB
LM 300849 / LM 300811	40,987	67,975	17,500	TRB
LM 48548 / LM 48510	34,925	65,088	18,034	TRB
LM 501349 / LM 501310	41,275	73,431	19,558	TRB
LM 501349 / LM 501314	41,275	73,431	21,430	TRB
LM 501349 / LM 501310	41,275	73,431	19,558	TRB
LM 503349 A / LM 503310	45,987	74,976	18,000	TRB
LM 506849 / LM 506810	55,000	90,000	23,000	TRB
LM 603049 / LM 603011	45,242	77,788	19,842	TRB
LM 603049 / LM 603012	45,242	77,788	21,430	TRB
LM 67048 / LM 67010	31,750	59,131	15,875	TRB
LM 78349 / LM 78310 A	34,987	61,973	16,702	TRB
LM 806649 / LM 806610	53,975	88,900	19,050	TRB
M 12649 / M 12610	21,430	50,005	17,526	TRB
M 802048 / M 802011	41,275	82,550	26,543	TRB
M 804049 / M 804010	47,625	88,900	25,400	TRB
M 84548 / M 84510	25,400	57,150	19,431	TRB
M 86647 / M 86610	28,575	64,292	21,433	TRB
M 86649 / M 86610	30,162	64,292	21,433	TRB
M 88043 / M 88010	30,162	68,262	22,225	TRB
M 88048 / M 88010	33,338	68,262	22,225	TRB

TRBDR				
F 15041	25,000	52,000	37,000	TRBDR
F 15043	25,000	55,000	43,000	TRBDR
F 15044	35,000	65,000	35,000	TRBDR
F 15067	29,000	53,000	37,000	TRBDR
F 15128	27,000	53,000	43,000	TRBDR
F 15151	27,000	52,000	45,0 / 50,0	TRBDR
F 15173	35,000	68,000	48,000	TRBDR
F 15175	25,000	55,000	45,000	TRBDR

TRBS				
F 15029	29,000	50,292	14,224	TRBS
F 15036	35,000	60,000	15,875	TRBS
F 15046	60,000	130,000	39,000	TRBS
F 15047	55,000	100,000	35,000	TRBS
F 15048	75,000	180,000	63,500	TRBS
F 15051 C	70,000	130,000	57,000	TRBS
F 15058	63,500	105,000	23,000	TRBS
F 15071	75,000	160,000	58,000	TRBS
F 15076	110,000	170,000	38,000	TRBS
F 15082	65,000	145,000	36,000	TRBS
F 15083	65,000	145,000	39,500	TRBS
F 15116	70,000	150,000	39,800	TRBS
F 15156	80,000	140,000	39,250	TRBS
F 15158	60,000	135,000	37,000	TRBS
F 15159	65,000	165,000	40,000	TRBS
F 15165	109,538	158,700	23,020	TRBS
F 15183	65,000	165,000	36,000	TRBS

TRBT				
T 163	41,529	72,619	21,433	TRBT
T 182	46,279	82,956	23,812	TRBT

U Series				
U 298 / U 261 L	34,987	64,975	18,100	U Series
U 399 / U 360 L	39,688	73,025	19,400	U Series
U 497 / U 460 L	44,987	79,975	24,000	U Series



Type of Bearing Dimensional List

Lista Dimensional por Tipo de Rolamento

Lista Dimensional por Tipo de Rodamiento

Dimensions / Dimensões / Dimensiones			Fersa®	
d	D	T		
BB				
8,000	22,000	7,000	608 2RS / C3	BB
10,000	26,000	8,000	6000 2RS / C3	BB
10,000	30,000	9,000	6200 2RS	BB
10,000	30,000	9,000	6200 2RS / C3	BB
10,000	35,000	11,000	6300 2RS / C3	BB
12,000	28,000	8,000	6001	BB
12,000	28,000	8,000	6001 2RS / C3	BB
12,000	28,000	8,000	6001 C3	BB
12,000	32,000	10,000	6201	BB
12,000	32,000	10,000	6201 2RS	BB
12,000	32,000	10,000	6201 2RS / C3	BB
12,000	32,000	10,000	6201 N 2RS / C3	BB
12,000	32,000	10,000	6201 RS / C3	BB
12,000	32,000	10,000	6201 Z	BB
12,000	32,000	10,000	6201 Z / C3	BB
12,000	32,000	10,000	6201 ZZ	BB
12,000	32,000	10,000	6201 ZZ / C3	BB
12,000	32,000	14,000	62201 2RS / C3	BB
12,000	37,000	12,000	6301 2RS / C3	BB
15,000	32,000	9,000	6002 2RS / C3	BB
15,000	35,000	11,000	6202	BB
15,000	35,000	11,000	6202 2RS	BB
15,000	35,000	11,000	6202 2RS / C3	BB
15,000	35,000	11,000	6202 C3	BB
15,000	35,000	11,000	6202 Z	BB
15,000	35,000	11,000	6202 Z / C3	BB
15,000	35,000	11,000	6202 ZZ	BB
15,000	35,000	11,000	6202 ZZ / C3	BB
15,000	35,000	14,000	62202 2RS / C3	BB
15,000	42,000	13,000	6302	BB
15,000	42,000	13,000	6302 2RS	BB
15,000	42,000	13,000	6302 2RS / C3	BB
15,000	42,000	13,000	6302 Z	BB
15,000	42,000	13,000	6302 ZZ / C3	BB
17,000	35,000	10,000	6003 2RS	BB
17,000	35,000	10,000	6003 2RS / C3	BB
17,000	40,000	12,000	6203	BB
17,000	40,000	12,000	6203 2RS	BB
17,000	40,000	12,000	6203 2RS / C3	BB
17,000	40,000	12,000	6203 C3	BB
17,000	40,000	12,000	6203 Z	BB
17,000	40,000	12,000	6203 ZZ	BB
17,000	40,000	12,000	6203 ZZ / C3	BB
17,000	47,000	14,000	6303	BB
17,000	47,000	14,000	6303 2RS	BB
17,000	47,000	14,000	6303 2RS / C3	BB
17,000	47,000	14,000	6303 C3	BB
17,000	47,000	14,000	6303 RS / C3	BB
17,000	47,000	14,000	6303 RSR / C3	BB
17,000	47,000	14,000	6303 Z	BB
17,000	47,000	14,000	6303 Z / C3	BB
17,000	47,000	14,000	6303 ZZ	BB
17,000	47,000	14,000	6303 ZZ / C3	BB
17,000	62,000	17,000	6403 2RS / C3	BB
17,000	62,000	17,000	6403 C3	BB
20,000	42,000	12,000	6004	BB
20,000	42,000	12,000	6004 2RS	BB
20,000	42,000	12,000	6004 2RS / C3	BB
20,000	42,000	12,000	6004 Z	BB
20,000	42,000	12,000	6004 ZZ / C3	BB
20,000	47,000	14,000	6204	BB

Dimensions / Dimensões / Dimensiones			Fersa®	
d	D	T		
20,000	47,000	14,000	6204 2RS	BB
20,000	47,000	14,000	6204 2RS / C3	BB
20,000	47,000	14,000	6204 C3	BB
20,000	47,000	14,000	6204 Z	BB
20,000	47,000	14,000	6204 ZZ	BB
20,000	47,000	14,000	6204 ZZ / C3	BB
20,000	47,000	18,000	62204 2RS	BB
20,000	52,000	15,000	6304	BB
20,000	52,000	15,000	6304 2RS	BB
20,000	52,000	15,000	6304 2RS / C3	BB
20,000	52,000	15,000	6304 C3	BB
20,000	52,000	15,000	6304 C4	BB
20,000	52,000	15,000	6304 ZZ	BB
20,000	52,000	15,000	6304 ZZ / C3	BB
25,000	47,000	12,000	6005	BB
25,000	47,000	12,000	6005 2RS	BB
25,000	47,000	12,000	6005 2RS / C3	BB
25,000	47,000	12,000	6005 ZZ / C3	BB
25,000	52,000	15,000	6205	BB
25,000	52,000	15,000	6205 2RS	BB
25,000	52,000	15,000	6205 2RS / C3	BB
25,000	52,000	15,000	6205 C3	BB
25,000	52,000	15,000	6205 RS	BB
25,000	52,000	15,000	6205 RS / C3	BB
25,000	52,000	15,000	6205 Z	BB
25,000	52,000	15,000	6205 ZZ	BB
25,000	52,000	15,000	6205 ZZ / C3	BB
25,000	52,000	18,000	62205 2RS	BB
25,000	62,000	17,000	6305	BB
25,000	62,000	17,000	6305 2RS	BB
25,000	62,000	17,000	6305 2RS / C3	BB
25,000	62,000	17,000	6305 C3	BB
25,000	62,000	17,000	6305 ZZ / C3	BB
25,000	72,000	19,000	6306 D25 2RS / C3	BB
28,575	71,438	20,638	RMS 9 2RS / C4	BB
30,000	55,000	13,000	6006	BB
30,000	55,000	13,000	6006 2RS	BB
30,000	55,000	13,000	6006 2RS / C3	BB
30,000	55,000	13,000	6006 RS / C3	BB
30,000	55,000	13,000	6006 ZZ / C3	BB
30,000	62,000	16,000	6206	BB
30,000	62,000	16,000	6206 2RS	BB
30,000	62,000	16,000	6206 2RS / C3	BB
30,000	62,000	16,000	6206 2RS / C4	BB
30,000	62,000	16,000	6206 C3	BB
30,000	62,000	16,000	6206 NR	BB
30,000	62,000	16,000	6206 NR 2RS	BB
30,000	62,000	16,000	6206 Z	BB
30,000	62,000	16,000	6206 ZZ	BB
30,000	62,000	16,000	6206 ZZ / C3	BB
30,000	62,000	20,000	62206 2RS	BB
30,000	72,000	19,000	6306	BB
30,000	72,000	19,000	6306 2RS	BB
30,000	72,000	19,000	6306 2RS / C3	BB
30,000	72,000	19,000	6306 C3	BB
30,000	72,000	19,000	6306 NR	BB
30,000	72,000	19,000	6306 NR 2RS / C3	BB
30,000	72,000	19,000	6306 ZNR	BB
30,000	72,000	19,000	6306 ZZ / C3	BB
30,000	72,000	19,000	6306 ZZ / C3	BB
35,000	62,000	14,000	6007	BB
35,000	62,000	14,000	6007 2RS	BB

TYPE OF BEARINGS DIMENSIONAL LIST
 LISTA DIMENSIONAL POR TIPO DE RODAMIENTO
 LISTA DIMENSIONAL POR TIPO DE RODAMIENTO

Dimensions / Dimensões / Dimensiones			Fersa®	
d	D	T		
35,000	62,000	14,000	6007 2RS / C3	BB
35,000	62,000	14,000	6007 C3	BB
35,000	62,000	14,000	6007 N	BB
35,000	72,000	17,000	6207	BB
35,000	72,000	17,000	6207 2RS	BB
35,000	72,000	17,000	6207 2RS / C3	BB
35,000	72,000	17,000	6207 C3	BB
35,000	72,000	17,000	6207 NR	BB
35,000	72,000	17,000	6207 NR 2RS	BB
35,000	72,000	17,000	6207 Z	BB
35,000	72,000	17,000	6207 ZN / C3	BB
35,000	72,000	17,000	6207 ZNR	BB
35,000	72,000	17,000	6207 ZZ	BB
35,000	80,000	21,000	6307	BB
35,000	80,000	21,000	6307 2RS	BB
35,000	80,000	21,000	6307 2RS / C3	BB
35,000	80,000	21,000	6307 C3	BB
35,000	80,000	21,000	6307 NR	BB
35,000	80,000	21,000	6307 NR 2RS	BB
35,000	80,000	21,000	6307 RS	BB
35,000	80,000	21,000	6307 Z	BB
35,000	80,000	21,000	6307 ZNR	BB
35,000	100,000	25,000	6407 C3	BB
40,000	68,000	15,000	6008	BB
40,000	68,000	15,000	6008 2RS	BB
40,000	68,000	15,000	6008 Z	BB
40,000	80,000	18,000	6208	BB
40,000	80,000	18,000	6208 2RS	BB
40,000	80,000	18,000	6208 2RS / C3	BB
40,000	80,000	18,000	6208 N	BB
40,000	80,000	18,000	6208 ZZ	BB
40,000	90,000	23,000	6308	BB
40,000	90,000	23,000	6308 2RS	BB
40,000	90,000	23,000	6308 NR / C4	BB
40,000	90,000	23,000	6308 ZNR	BB
40,000	90,000	23,000	6308 ZNR / C3	BB
40,000	110,000	27,000	6408	BB
40,000	110,000	27,000	6408 NR / C3	BB
45,000	68,000	12,000	61909	BB
45,000	75,000	16,000	6009	BB
45,000	75,000	16,000	6009 2RS	BB
45,000	75,000	16,000	6009 C3	BB
45,000	75,000	16,000	6009 NR	BB
45,000	75,000	16,000	6009 ZZ	BB
45,000	85,000	19,000	6209	BB
45,000	85,000	19,000	6209 2RS	BB
45,000	85,000	19,000	6209 C3	BB
45,000	85,000	19,000	6209 NR	BB
45,000	85,000	19,000	6209 NR / C3	BB
45,000	85,000	19,000	6209 ZZ	BB
45,000	100,000	25,000	6309	BB
45,000	100,000	25,000	6309 2RS	BB
45,000	100,000	25,000	6309 NR	BB
45,000	100,000	25,000	6309 NR / C3	BB
45,000	100,000	25,000	6309 Z / C3	BB
45,000	100,000	25,000	6309 ZNR / C3	BB
45,000	120,000	29,000	6409	BB
45,000	120,000	29,000	6409 C3	BB
45,000	120,000	29,000	6409 NR / C3	BB
50,000	80,000	16,000	6010	BB
50,000	80,000	16,000	6010 2RS	BB
50,000	80,000	16,000	6010 C3	BB
50,000	80,000	16,000	6010 Z	BB
50,000	90,000	20,000	6210	BB
50,000	90,000	20,000	6210 2RS	BB
50,000	90,000	20,000	6210 Z	BB
50,000	90,000	20,000	6210 ZZ	BB
50,000	90,000	20,000	6210 ZZ NR	BB
50,000	90,000	20,000	7210 B	BB
50,000	110,000	27,000	6310	BB
50,000	110,000	27,000	6310 2RS	BB

Dimensions / Dimensões / Dimensiones			Fersa®	
d	D	T		
50,000	110,000	27,000	6310 C3	BB
55,000	90,000	18,000	6011	BB
55,000	90,000	18,000	6011 C3	BB
55,000	90,000	18,000	6011 ZZ	BB
55,000	100,000	21,000	6211	BB
55,000	100,000	21,000	6211 2RS	BB
55,000	100,000	21,000	6211 C3	BB
55,000	100,000	21,000	6211 N / C3	BB
55,000	100,000	21,000	6211 Z	BB
55,000	100,000	21,000	6211 ZNR	BB
55,000	120,000	29,000	6311	BB
55,000	120,000	29,000	6311 C3	BB
55,000	120,000	29,000	6311 NR / C3	BB
60,000	110,000	22,000	6212	BB
60,000	110,000	22,000	6212 2RS	BB
60,000	110,000	22,000	6212 NR	BB
60,000	110,000	22,000	6212 ZNR	BB
60,000	130,000	31,000	6312 C3	BB
60,000	130,000	31,000	6312 NR / C3	BB
65,000	100,000	18,000	6013	BB
65,000	120,000	23,000	6213 C3	BB
65,000	140,000	33,000	6313 C3	BB
70,000	110,000	20,000	6014	BB
70,000	110,000	20,000	6014 2RS	BB
70,000	110,000	20,000	6014 2RS / C3	BB
70,000	110,000	20,000	6014 2RS / C4	BB
70,000	110,000	20,000	6014 C3	BB
70,000	125,000	24,000	6214	BB
70,000	150,000	35,000	6314	BB
70,000	150,000	35,000	6314 C3	BB
70,000	150,000	35,000	6314 N / C3	BB
70,000	150,000	35,000	6314 NR / C3	BB
75,000	115,000	20,000	6015 Z	BB
75,000	130,000	25,000	6215 C3	BB
75,000	130,000	25,000	6215 NR / C3	BB
80,000	125,000	22,000	6016 2RS / C3	BB
80,000	140,000	26,000	6216 C3	BB
85,000	130,000	22,000	6017 NR	BB
90,000	160,000	30,000	6218 C3	BB
BB2R				
30,000	62,000	23,800	3206 B	BB2R
35,000	72,000	27,000	3207 B	BB2R
BB4PAC				
40,000	80,000	18,000	QJ 208 FM	BB4PAC
45,000	85,000	19,000	QJ 209 FM	BB4PAC
45,000	100,000	25,000	QJ 309 FM	BB4PAC
60,000	110,000	22,000	QJ 212 FM	BB4PAC
BBDRC				
30,000	55,000	23,000	F 16098	BBDRC
30,000	62,000	27,000	F 16104	BBDRC
30,000	120,000	63,500	F 16065	BBDRC
30,000	120,000	68,500	F 16013	BBDRC
34,000	64,000	37,000	F 16019	BBDRC
34,000	66,000	37,000	F 16020	BBDRC
34,000	67,000	37,000	F 16083	BBDRC
35,000	50,000	20,000	F 16097	BBDRC
35,000	50,000	20,000	F 16099	BBDRC
35,000	52,000	22,000	F 16101	BBDRC
35,000	55,000	20,000	F 16100	BBDRC
35,000	65,000	35,000	F 16021	BBDRC
35,000	66,000	37,000	F 16023	BBDRC
35,000	72,000	33,000	F 16026	BBDRC
35,000	136,000	75,000	F 16028	BBDRC
37,000	72,000	33,000	F 16029	BBDRC
37,000	72,000	37,000	F 16030	BBDRC
37,000	74,000	45,000	F 16032	BBDRC
37,990	74,020	36,000	F 16034	BBDRC
38,100	70,000	37,000	F 16057	BBDRC
39,100	68,000	37,000	F 16035	BBDRC
39,000	72,000	37,000	F 16036	BBDRC

Dimensions / Dimensões / Dimensiones			Fersa®	
d	D	T		
39,000	72,000	37,000	F 16110	BBDRAC
39,000	74,000	39,000	F 16037	BBDRAC
39,000	75,000	37,000	F 16038	BBDRAC
39,980	108,000	32,000	F 16044	BBDRAC
40,000	46,000	33,000	F 16198	BBDRAC
40,000	62,000	20,625	F 16103	BBDRAC
40,000	62,000	24,000	F 16102	BBDRAC
40,000	72,000	37,000	F 16039	BBDRAC
40,000	74,000	40,000	F 16040	BBDRAC
40,000	75,000	37,000	F 16055	BBDRAC
42,000	76,000	38,000	F 16081	BBDRAC
42,000	76,000	39,000	F 16194	BBDRAC
42,000	76,000	40,000	F 16195	BBDRAC
42,000	76,000	43,000	F 16197	BBDRAC
42,000	80,000	45,000	F 16088	BBDRAC
42,000	82,000	36,000	F 16048	BBDRAC
42,000	84,030	39,000	F 16051	BBDRAC
43,000	76,000	43,000	F 16196	BBDRAC
43,000	79,000	41,000	F 16052	BBDRAC
43,000	82,000	37,000	F 16054	BBDRAC
43,000	82,000	45,000	F 16078	BBDRAC
45,000	84,000	39,000	F 16058	BBDRAC
45,000	84,020	39,000	F 16059	BBDRAC
47,000	81,000	53,000	F 16199	BBDRAC

BBS				
25,000	62,020	24,000	F 18018	BBS
25,995	68,000	19,700	F 18024	BBS
28,000	66,000	18,000	F 18021	BBS
36,513	68,000	15,000	F 18039	BBS
50,000	90,000	20,000	F 18041	BBS
55,000	91,500	25,000	F 15141	BBS
60,000	96,500	25,700	F 15140	BBS
60,000	96,500	29,700	F 15139	BBS
63,500	100,000	23,000	F 18040	BBS
63,500	102,000	20,570	F 18031	BBS

CRB				
17,000	47,000	14,000	NU 303 FM	CRB
17,000	47,000	14,000	NU 303 FM / C3	CRB
17,000	47,000	14,000	NU 303 FMN	CRB
20,000	52,000	15,000	NJ 304 FM	CRB
20,000	52,000	15,000	NJ 304 FMN	CRB
20,000	52,000	15,000	NUP 304 FM	CRB
25,000	52,000	15,000	NJ 205 / C3	CRB
25,000	52,000	18,000	NU 2205	CRB
25,000	52,000	18,000	NUP 2205	CRB
25,000	62,000	17,000	NJ 305 C3	CRB
25,000	62,000	17,000	NJ 305 FM / C3	CRB
30,000	62,000	16,000	NJ 206	CRB
30,000	62,000	16,000	NU 206 FM	CRB
30,000	62,000	16,000	NUP 206 FM	CRB
30,000	62,000	20,000	NJ 2206 FM	CRB
30,000	72,000	19,000	N 306 F	CRB
35,000	72,000	17,000	N 207 / C3	CRB
35,000	80,000	21,000	N 307 FM	CRB
35,000	80,000	21,000	NJ 307 FM	CRB
40,000	80,000	18,000	NU 208 FM	CRB
40,000	90,000	23,000	NUP 308 FM	CRB
45,000	85,000	19,000	NU 209 FMN	CRB
45,000	85,000	190,000	NU 209 FMN / C3	CRB
45,000	100,000	25,000	N 309 FM	CRB
45,000	100,000	25,000	NJ 309 FM	CRB
45,000	100,000	25,000	NJ 309 C3	CRB
45,000	100,000	25,000	NJ 309 FM	CRB
45,000	100,000	25,000	NJ 309 FM / C3	CRB
45,000	100,000	25,000	NUP 309	CRB
45,000	100,000	25,000	NUP 309 C3	CRB
45,000	100,000	25,000	NUP 309 FM	CRB
45,000	100,000	25,000	NUP 309 FM / C3	CRB
45,000	100,000	36,000	NJ 2309 F / C3	CRB
50,000	110,000	27,000	NU 310 FM	CRB
50,000	110,000	27,000	NU 310 FM / C3	CRB

Dimensions / Dimensões / Dimensiones			Fersa®	
d	D	T		
50,000	110,000	27,000	NUP 310 FM / C3	CRB
50,000	110,000	27,000	NUP 310 FMN / C3	CRB
55,000	90,000	18,000	NU 1011 FM	CRB
55,000	100,000	25,000	N 2211 FMNR / C3	CRB
55,000	100,000	25,000	NJ 2211 FM	CRB
55,000	120,000	29,000	NUP 311 FM	CRB
55,000	120,000	29,000	NUP 311 FM / C3	CRB
55,000	120,000	29,000	NUP 311 FMNR / C3	CRB
60,000	110,000	22,000	NUP 212 FM	CRB
60,000	110,000	28,000	NUP 2212 F	CRB
60,000	110,000	28,000	NUP 2212 FMN	CRB
70,000	150,000	35,000	NUP 314 FM	CRB
70,000	150,000	35,000	NUP 314 FM / C3	CRB
70,000	150,000	35,000	NUP 314 FMN / C3	CRB
70,000	150,000	35,000	NUP 314 FMNR	CRB
70,000	150,000	35,000	NUP 314 FMNR / C3	CRB

CRBS				
25,000	52,000	21,000	F 19029	CRBS
30,000	60,000	26,000	F 19019	CRBS
30,000	110,000	32,300	F 19075	CRBS
34,993	80,000	23,000	F 19043	CRBS
35,000	80,000	22,000	F 19020	CRBS
35,000	80,000	23,000	F 19012	CRBS
36,000	56,300	20,000	F 19048	CRBS
38,000	94,000	33,000	F 19076	CRBS
40,000	90,000	23,000	F 19034	CRBS
40,000	90,000	25,000	F 19033	CRBS
40,000	90,000	27,000	F 19013	CRBS
45,000	95,000	32,000	F 19015	CRBS
45,000	100,000	25,000	F 19002	CRBS
45,000	100,000	25,000	F 19044	CRBS
45,000	100,000	36,000	F 19001	CRBS
50,000	100,000	25,000	F 19046	CRBS
60,000	110,000	22,000	F 19011	CRBS
60,000	110,000	28,000	F 19042	CRBS
60,000	116,000	28,000	F 19047	CRBS
60,000	130,000	31,000	F 19009	CRBS
63,000	97,450	34,750	F 19016	CRBS
65,000	140,000	33,350	F 19010	CRBS
80,000	140,000	33,500	F 19039	CRBS
80,000	150,000	28,000	F 19008	CRBS

CWT				
45,000	120,000	84,900	F 300006	CWT

HWT				
68,000	127,000	115,000	F 15097	HWT

KWT				
58,000	110,000	115,000	F 200003	KWT
68,000	125,000	115,000	F 200001 A	KWT
93,800	148,000	135,000	F 200002 A	KWT
105,000	160,000	140,000	F 200004	KWT

TRB				
15,000	42,000	14,250	30302 F	TRB
15,875	42,862	14,288	11590 / 11520	TRB
17,000	40,000	13,250	30203 F	TRB
17,000	47,000	15,250	30303 F	TRB
17,462	39,878	13,843	LM 11749 / LM 11710	TRB
19,050	39,992	12,014	A 6075 / A 6157	TRB
19,050	45,237	15,494	LM 11949 / LM 11910	TRB
20,000	47,000	15,250	30204 F	TRB
20,000	52,000	16,250	30304 F	TRB
20,000	52,000	22,250	32304 F	TRB
21,430	45,237	15,494	LM 12748 / LM 12710	TRB
21,430	50,005	17,526	M 12649 / M 12610	TRB
21,986	45,237	15,494	LM 12749 / LM 12710	TRB
21,986	45,974	15,494	LM 12749 / LM 12711	TRB
22,225	52,388	19,368	1380 / 1328	TRB
25,000	52,000	16,250	30205 F	TRB
25,000	52,000	19,250	32205 BF	TRB

TYPE OF BEARINGS DIMENSIONAL LIST

LISTA DIMENSIONAL POR TIPO DE RODAMIENTO

LISTA DIMENSIONAL POR TIPO DE RODAMIENTO

Dimensions / Dimensões / Dimensiones			Fersa®	
d	D	T		
25,000	52,000	19,250	32205 F	TRB
25,000	52,000	22,000	33205 F	TRB
25,000	62,000	18,250	30305 F	TRB
25,000	62,000	25,250	32305 F	TRB
25,400	50,292	14,224	L 44643 / L 44610	TRB
25,400	57,150	19,431	M 84548 / M 84510	TRB
25,400	62,000	19,050	15101 / 15245	TRB
26,162	61,912	19,050	15103 S / 15243	TRB
26,988	50,292	14,224	L 44649 / L 44610	TRB
26,988	63,500	20,638	15106 / 15250 X	TRB
28,575	64,292	21,433	M 86647 / M 86610	TRB
28,575	66,421	23,812	2689 / 2631	TRB
29,000	50,292	14,224	L 45449 / L 45410	TRB
30,000	55,000	17,000	32006 XF	TRB
30,000	62,000	17,250	30206 F	TRB
30,000	62,000	21,250	32206 F	TRB
30,000	72,000	20,750	30306 F	TRB
30,000	72,000	20,750	31306 F	TRB
30,000	72,000	28,750	32306 F	TRB
30,162	64,292	21,433	M 86649 / M 86610	TRB
30,162	68,262	22,225	M 88043 / M 88010	TRB
30,226	69,012	19,845	14116 / 14276	TRB
31,750	59,131	15,875	LM 67048 / LM 67010	TRB
31,750	73,025	29,370	HM 88542 / HM 88510	TRB
32,000	53,000	14,500	JL 26749 F / JL 26710	TRB
33,338	68,262	22,225	M 88048 / M 88010	TRB
33,338	69,012	19,845	14131 / 14276	TRB
33,338	72,626	30,162	3196 / 3120	TRB
33,338	76,200	29,369	HM 89443 / HM 89411	TRB
34,925	65,088	18,034	LM 48548 / LM 48510	TRB
34,925	68,262	20,638	14585 / 14525	TRB
34,925	72,233	25,400	HM 88649 / HM 88610	TRB
34,925	73,025	23,812	25877 / 25820	TRB
34,925	73,025	23,812	25877 / 25821	TRB
34,925	76,200	29,370	31594 / 31520	TRB
34,987	59,131	15,875	L 68149 / L 68110	TRB
34,987	59,975	15,875	L 68149 / L 68111	TRB
34,987	61,973	16,702	LM 78349 / LM 78310 A	TRB
35,000	62,000	18,000	32007 XF	TRB
35,000	72,000	18,250	30207 F	TRB
35,000	72,000	24,250	32207 F	TRB
35,000	72,000	28,000	33207 F	TRB
35,000	80,000	22,750	30307 F	TRB
35,000	80,000	32,750	32307 F	TRB
36,487	73,025	23,812	25880 / 25820	TRB
36,487	76,200	23,812	2780 / 2720	TRB
36,512	76,200	29,370	31597 / 31520	TRB
36,512	76,200	29,370	HM 89449 / HM 89410	TRB
38,000	63,000	17,000	JL 69349 / JL 69310	TRB
38,000	63,000	17,000	JL 69349 X / JL 69310	TRB
38,100	65,088	18,034	LM 29749 / LM 29710	TRB
38,100	65,088	19,812	LM 29749 / LM 29711	TRB
39,688	76,200	23,812	2789 / 2720	TRB
39,688	80,167	29,370	3382 / 3320	TRB
40,000	68,000	19,000	32008 XF	TRB
40,000	80,000	19,750	30208 F	TRB
40,000	80,000	24,750	32208 F	TRB
40,000	80,000	32,000	33208 F	TRB
40,000	85,000	33,000	JF 4049 / JF 4010	TRB
40,000	90,000	25,250	30308 F	TRB
40,000	90,000	25,250	31308 F	TRB
40,000	90,000	35,250	32308 BF	TRB
40,000	90,000	35,250	32308 F	TRB
40,987	67,975	17,500	LM 300849 / LM 300811	TRB
41,275	73,431	19,558	LM 501349 / LM 501310	TRB
41,275	73,431	19,558	LM 501349 / LM 501310	TRB
41,275	73,431	21,430	LM 501349 / LM 501314	TRB
41,275	82,550	26,543	M 802048 / M 802011	TRB
41,275	87,312	30,162	3585 / 3525	TRB
41,275	88,900	30,162	HM 803146 / HM 803110	TRB
41,275	88,900	30,163	HM 803145 / HM 803110	TRB
41,275	104,775	36,512	59162 / 59412	TRB
42,862	76,992	17,464	12168 / 12303	TRB

Dimensions / Dimensões / Dimensiones			Fersa®	
d	D	T		
42,875	82,931	26,988	25577 / 25523	TRB
44,450	76,992	17,464	12175 / 12303	TRB
44,450	82,931	23,812	25580 / 25520	TRB
44,450	82,931	23,813	25581 / 25520	TRB
44,450	88,900	30,162	HM 803149 / HM 803110	TRB
44,450	93,264	30,162	3782 / 3720	TRB
44,450	95,250	27,783	33885 / 33822	TRB
44,450	95,250	30,162	HM 804843 / HM 804810	TRB
44,450	95,250	30,958	53178 / 53377	TRB
44,450	95,250	30,958	HM 903249 / HM 903210	TRB
44,450	104,775	36,512	59175 / 59412	TRB
44,450	104,775	36,512	HM 807040 / HM 807010	TRB
44,987	104,986	32,512	HM 905843 / HM 905810	TRB
45,000	75,000	20,000	32009 XF	TRB
45,000	80,000	26,000	33109 F	TRB
45,000	85,000	20,750	30209 F	TRB
45,000	85,000	32,000	33209 F	TRB
45,000	95,000	36,000	JF 4549 / JF 4510	TRB
45,000	100,000	27,250	30309 F	TRB
45,000	100,000	27,250	31309 F	TRB
45,000	100,000	38,250	32309 F	TRB
45,230	79,985	19,842	17887 / 17831	TRB
45,237	87,312	30,163	3586 / 3525	TRB
45,242	73,431	19,558	LM 102949 / LM 102910	TRB
45,242	77,788	19,842	LM 603049 / LM 603011	TRB
45,242	77,788	21,430	LM 603049 / LM 603012	TRB
45,618	82,931	23,812	25590 / 25520	TRB
45,618	83,058	23,876	25590 / 25522	TRB
45,987	74,976	18,000	LM 503349 A / LM 503310	TRB
47,625	88,900	25,400	M 804049 / M 804010	TRB
47,625	95,250	30,162	HM 804846 / HM 804810	TRB
47,625	123,825	36,152	72188 C / 72487	TRB
50,000	80,000	20,000	32010 XF	TRB
50,000	82,000	21,500	JLM 104948 / JLM 104910	TRB
50,000	82,550	23,148	JLM 104946 / JLM 104911 A	TRB
50,000	85,000	26,000	33110 F	TRB
50,000	90,000	21,750	30210 F	TRB
50,000	90,000	24,750	32210 F	TRB
50,000	90,000	28,000	JM 205149 / JM 205110	TRB
50,000	90,000	32,000	33210 F	TRB
50,000	100,000	36,000	JF 5049 / JF 5010	TRB
50,000	110,000	42,250	32310 F	TRB
50,800	82,000	21,500	LM 104949 / LM 104910	TRB
50,800	82,550	21,590	LM 104949 / LM 104911	TRB
50,800	82,931	21,590	LM 104949 / LM 104912	TRB
50,800	88,900	20,638	368 A / 362 A	TRB
50,800	90,000	25,000	368 A / 362 X	TRB
50,800	93,264	30,162	3780 / 3720	TRB
50,800	93,264	30,163	3775 / 3720	TRB
50,800	95,250	27,783	33889 / 33822	TRB
50,800	104,775	30,162	45284 / 45220	TRB
50,800	104,775	36,512	HM 807046 / HM 807010	TRB
50,800	104,775	36,512	HM 807046 / HM 807011	TRB
50,800	107,950	36,512	537 / 532 X	TRB
50,800	111,125	30,162	55200 C / 55437	TRB
50,800	123,825	36,512	72200 C / 72487	TRB
51,592	90,000	20,000	368 S / 362	TRB
52,388	111,125	30,162	55206 C / 55437	TRB
53,975	88,900	19,050	LM 806649 / LM 806610	TRB
53,975	95,250	27,783	33895 / 33821	TRB
53,975	95,250	27,783	33895 / 33822	TRB
53,975	104,775	36,512	HM 807049 / HM 807010	TRB
53,975	123,825	36,152	72212 C / 72487	TRB
53,975	140,030	36,513	78215 C / 78551	TRB
55,000	90,000	23,000	32011 XF	TRB
55,000	90,000	23,000	LM 506849 / LM 506810	TRB
55,000	90,000	25,000	JLM 506849 A / JLM 506811	TRB
55,000	90,000	27,000	33011 F	TRB
55,000	95,000	29,000	JM 207049 / JM 207010	TRB
55,000	95,000	29,000	JM 207049 A / JM 207010	TRB
55,000	95,000	30,000	33111 F	TRB

Dimensions / Dimensões / Dimensiones			Fersa®	
d	D	T		
55,000	100,000	22,750	30211 F	TRB
55,000	100,000	26,750	32211 F	TRB
55,000	120,000	31,500	31311 F	TRB
55,000	120,000	45,500	32311 F	TRB
55,562	123,825	36,152	72218 C / 72487	TRB
57,150	96,838	21,000	387 / 382 A	TRB
57,150	96,838	21,000	387 A / 382 A	TRB
57,150	96,838	21,000	387 AS / 382 A	TRB
57,150	96,838	25,400	387 A / 382 S	TRB
57,150	97,630	24,608	28682 / 28622	TRB
57,150	100,000	21,000	387 A / 383 A	TRB
57,150	104,775	30,162	45291 / 45220	TRB
57,150	104,775	30,162	469 / 453 X	TRB
57,150	107,950	27,975	469 / 453	TRB
57,150	112,712	30,162	39580 / 39520	TRB
57,150	112,712	30,162	39581 / 39520	TRB
57,150	117,475	33,338	66225 / 66462	TRB
57,150	123,825	38,100	555 S / 552 A	TRB
57,150	140,030	36,513	78225 C / 78551	TRB
57,531	98,425	21,000	388 A / 382	TRB
60,000	95,000	23,000	32012 XF	TRB
60,000	95,000	24,000	JLM 508748 / JLM 508710	TRB
60,000	100,000	30,000	33112 F	TRB
60,000	110,000	23,750	30212 F	TRB
60,000	110,000	29,750	32212 F	TRB
60,000	110,000	38,000	33212 F	TRB
60,000	115,000	40,000	JF 6049 / JF 6010	TRB
60,000	130,000	33,500	30312 F	TRB
60,000	130,000	33,500	31312 F	TRB
60,000	130,000	48,500	32312 F	TRB
60,325	100,000	25,400	28985 / 28921	TRB
60,325	122,238	38,100	HM 212044 / HM 212011	TRB
60,325	127,000	36,512	HM 813841 / HM 813810	TRB
60,325	127,000	44,450	65237 / 65500	TRB
60,325	130,175	36,512	HM 911245 / HM 911210	TRB
61,912	127,000	36,512	HM 813843 / HM 813810	TRB
61,912	136,525	46,038	H 715334 / H 715311	TRB
61,912	146,050	41,275	H 913842 / H 913810	TRB
63,500	104,775	21,433	39250 / 39412	TRB
63,500	112,712	30,162	39585 / 39520	TRB
63,500	112,712	30,162	3982 / 3920	TRB
63,500	122,238	38,100	HM 212047 / HM 212011	TRB
63,500	123,825	38,100	559 / 552 A	TRB
63,500	127,000	36,512	HM 813842 / HM 813810	TRB
65,000	105,000	24,000	JLM 710949 / JLM 710910	TRB
65,000	105,000	24,000	JLM 710949 C / JLM 710910	TRB
65,000	110,000	28,000	JM 511946 / JM 511910	TRB
65,000	110,000	31,000	JD 6549 / JD 6510	TRB
65,000	110,000	34,000	33113 F	TRB
65,000	120,000	24,750	30213 F	TRB
65,000	120,000	32,750	32213 F	TRB
65,000	120,000	39,000	JH 211749 / JH 211710	TRB
65,000	120,000	41,000	33213 F	TRB
65,000	140,000	36,000	30313 F	TRB
65,000	140,000	36,000	31313 F	TRB
65,000	140,000	51,000	32313 BF	TRB
65,000	140,000	51,000	32313 F	TRB
66,675	110,000	22,000	395 A / 394 A	TRB
66,675	112,712	30,162	39590 / 39520	TRB
66,675	112,712	30,162	3984 / 3920	TRB
66,675	112,712	30,162	3994 / 3920	TRB
66,675	122,238	38,100	HM 212049 / HM 212011	TRB
66,675	135,755	53,975	6386 / 6320	TRB
66,675	136,525	41,275	641 / 632	TRB
68,262	136,525	46,038	H 715343 / H 715311	TRB
68,262	152,400	47,626	H 914841 / H 914811	TRB
68,262	161,925	49,212	9278 / 9220	TRB
69,850	120,000	29,794	33275 / 33472	TRB
69,850	120,000	29,794	482 / 472	TRB
69,850	120,000	32,545	47487 / 47420 A	TRB
69,850	120,650	25,400	29675 / 29630	TRB
69,952	125,052	47,450	34274 / 34492 A	TRB
70,000	110,000	25,000	32014 XF	TRB

Dimensions / Dimensões / Dimensiones			Fersa®	
d	D	T		
70,000	120,000	37,000	33114 F	TRB
70,000	125,000	26,250	30214 F	TRB
70,000	125,000	33,250	32214 F	TRB
70,000	125,000	41,000	33214 F	TRB
70,000	140,000	39,000	JW 7049 / JW 7010	TRB
70,000	150,000	38,000	30314 F	TRB
70,000	150,000	38,000	31314 F	TRB
70,000	150,000	54,000	32314 BF	TRB
71,438	117,475	30,162	33281 / 33462	TRB
71,438	120,000	32,545	47490 / 47420	TRB
71,438	127,000	36,512	HM 813849 / HM 813810	TRB
71,438	136,525	46,038	H 715345 / H 715311	TRB
73,025	112,712	25,400	29685 / 29620	TRB
73,025	117,475	30,162	33287 / 33462	TRB
73,025	127,000	36,512	567 / 563	TRB
75,000	115,000	25,000	32015 XF	TRB
75,000	115,000	25,000	JLM 714149 / JLM 714110	TRB
75,000	120,000	31,000	JM 714249 / JM 714210	TRB
75,000	125,000	37,000	33115 F	TRB
75,000	130,000	33,250	32215 F	TRB
75,000	130,000	41,000	33215 F	TRB
75,000	160,000	40,000	31315 F	TRB
75,000	160,000	58,000	32315 BF	TRB
75,000	160,000	58,000	32315 F	TRB
76,200	127,000	30,162	42688 / 42620	TRB
76,200	136,525	30,163	495 A / 493	TRB
76,200	136,525	30,163	495 AX / 493	TRB
76,200	149,225	53,975	6461 A / 6420	TRB
76,200	161,925	49,212	9285 / 9220	TRB
77,788	121,442	24,608	34306 / 34478	TRB
80,000	125,000	29,000	32016 XF	TRB
80,000	130,000	37,000	33116 F	TRB
80,000	140,000	28,250	30216 F	TRB
80,000	140,000	35,250	32216 F	TRB
80,000	170,000	61,500	32316 F	TRB
80,962	136,525	30,163	496 / 493	TRB
80,962	139,992	36,513	581 / 572	TRB
82,550	133,350	33,338	47686 / 47620	TRB
82,550	133,350	39,687	HM 516449 / HM 516410	TRB
82,550	139,982	35,250	580 / 572 A	TRB
82,550	139,992	36,512	580 / 572	TRB
82,550	146,050	41,275	663 / 653	TRB
82,550	152,400	41,275	663 / 652	TRB
84,138	133,350	30,163	498 / 492 A	TRB
84,138	133,350	30,163	498 A / 492 A	TRB
84,138	136,525	30,163	498 / 493	TRB
85,000	130,000	29,000	32017 XF	TRB
85,000	130,000	30,000	JM 716649 / JM 716610	TRB
85,000	130,000	36,000	33017 F	TRB
85,000	140,000	41,000	33117 F	TRB
85,000	150,000	30,500	30217 F	TRB
85,026	150,089	44,450	749 / 742	TRB
85,725	133,350	30,163	497 / 492 A	TRB
85,725	136,525	30,163	497 / 493	TRB
85,725	146,050	41,275	665 / 653	TRB
85,725	152,400	41,275	665 / 652	TRB
87,960	148,430	28,575	42346 / 42584	TRB
88,900	148,430	28,575	42350 / 42584	TRB
88,900	152,400	39,688	HM 518445 / HM 518410	TRB
89,974	146,975	40,000	HM 218248 / HM 218210	TRB
90,000	140,000	32,000	32018 XF	TRB
90,000	140,000	39,000	33018 F	TRB
90,000	160,000	42,500	32218 F	TRB
90,488	161,925	47,625	760 / 752	TRB
92,075	146,050	33,338	47890 / 47820	TRB
92,075	150,000	35,992	598 A / 593 X	TRB
92,075	152,400	39,688	598 A / 592 A	TRB
92,075	168,275	41,275	681 A / 672	TRB
93,662	148,430	28,575	42368 / 42584	TRB
95,000	135,000	20,000	JL 819349 / JL 819310	TRB
95,000	145,000	32,000	32019 XF	TRB
95,000	145,000	39,000	33019 F	TRB
95,000	170,000	45,500	32219 F	TRB

TYPE OF BEARINGS DIMENSIONAL LIST

LISTA DIMENSIONAL POR TIPO DE RODAMIENTO

LISTA DIMENSIONAL POR TIPO DE RODAMIENTO

Dimensions / Dimensões / Dimensiones			Fersa®	
d	D	T		
95,250	152,400	39,688	594 / 592	TRB
95,250	152,400	39,688	594 / 592 A	TRB
95,250	152,400	39,688	594 A / 592 A	TRB
95,250	168,275	41,275	683 / 672	TRB
96,838	148,430	28,575	42381 / 42584	TRB
99,975	156,975	42,000	HM 220149 / HM 220110	TRB
100,000	150,000	32,000	32020 XF	TRB
100,000	150,000	39,000	33020 F	TRB
100,000	155,000	36,000	JM 720249 / JM 720210	TRB
100,000	160,000	41,000	JHM 720249 / JHM 720210	TRB
100,000	165,000	47,000	JF 10049 / JF 10010	TRB
100,000	180,000	37,000	30220 F	TRB
100,000	180,000	49,000	32220 F	TRB
101,600	157,162	36,512	52400 / 52618	TRB
101,600	168,275	41,275	687 / 672	TRB
105,000	160,000	35,000	32021 XF	TRB
105,000	160,000	43,000	33021 F	TRB
107,950	165,100	36,512	56425 / 56650	TRB
109,538	158,750	23,020	37431 / 37625	TRB
109,538	158,750	23,020	37431 A / 37625	TRB
110,000	170,000	38,000	32022 XF	TRB
110,000	170,000	47,000	33022 F	TRB
110,000	180,000	47,000	JHM 522649 / JHM 522610	TRB
110,000	200,000	41,000	30222 F	TRB
114,300	177,800	41,275	64450 / 64700	TRB
114,300	180,975	34,925	68450 / 68712	TRB
117,475	180,975	34,925	68462 / 68712	TRB
120,000	170,000	27,000	JP 12049 / JP 12010	TRB
120,000	170,000	27,000	JP 12049 A / JP 12010	TRB
120,000	180,000	38,000	32024 XF	TRB
---	42,800	---	11 BC	TRB

TRBDR				
25,000	52,000	37,000	F 15041	TRBDR
25,000	55,000	43,000	F 15043	TRBDR
25,000	55,000	45,000	F 15175	TRBDR
27,000	52,000	45,0 / 50,0	F 15151	TRBDR
27,000	53,000	43,000	F 15128	TRBDR
29,000	53,000	37,000	F 15067	TRBDR
35,000	65,000	35,000	F 15044	TRBDR
35,000	68,000	48,000	F 15173	TRBDR

TRBS				
29,000	50,292	14,224	F 15029	TRBS
35,000	60,000	15,875	F 15036	TRBS
55,000	100,000	35,000	F 15047	TRBS
60,000	130,000	39,000	F 15046	TRBS
60,000	135,000	37,000	F 15158	TRBS
63,500	105,000	23,000	F 15058	TRBS
65,000	145,000	36,000	F 15082	TRBS
65,000	145,000	39,500	F 15083	TRBS
65,000	165,000	36,000	F 15183	TRBS
65,000	165,000	40,000	F 15159	TRBS
70,000	130,000	57,000	F 15051 C	TRBS
70,000	150,000	39,800	F 15116	TRBS
75,000	160,000	58,000	F 15071	TRBS
75,000	180,000	63,500	F 15048	TRBS
80,000	140,000	39,250	F 15156	TRBS
109,538	158,700	23,020	F 15165	TRBS
110,000	170,000	38,000	F 15076	TRBS

TRBT				
41,529	72,619	21,433	T 163	TRBT
46,279	82,956	23,812	T 182	TRBT

U Series				
34,987	64,975	18,100	U 298 / U 261 L	U Series
39,688	73,025	19,400	U 399 / U 360 L	U Series
44,987	79,975	24,000	U 497 / U 460 L	U Series

Fersa References with Multiple Applications

Referências Fersa com Múltiplas Aplicações

Referencias Fersa con Multiples Aplicaciones

10.6

Fersa®	Dimensions / Dimensões / Dimensiones			
	d	D	T	
11 BC	---	42,800	---	TRB
14585 / 14525	34,925	68,262	20,638	TRB
17887 / 17831	45,230	79,985	19,842	TRB
28985 / 28921	60,325	100,000	25,400	TRB
30211 F	55,000	100,000	22,750	TRB
30303 F	17,000	47,000	15,250	TRB
32006 XF	30,000	55,000	17,000	TRB
37431 A / 37625	109,538	158,750	23,020	TRB
37431 / 37625	109,538	158,750	23,020	TRB
387 A / 383 A	57,150	100,000	21,000	TRB
395 A / 394 A	66,675	110,000	22,000	TRB
47490 / 47420	71,438	120,000	32,545	TRB
6000 2RS / C3	10,000	26,000	8,000	BB
6002 2RS / C3	15,000	32,000	9,000	BB
6003 2RS	17,000	35,000	10,000	BB
6004 2RS / C3	20,000	42,000	12,000	BB
6004 ZZ / C3	20,000	42,000	12,000	BB
6005 ZZ / C3	25,000	47,000	12,000	BB
6006 ZZ / C3	30,000	55,000	13,000	BB
6007 2RS / C3	35,000	62,000	14,000	BB
6014 2RS / C3	70,000	110,000	20,000	BB
6016 2RS / C3	80,000	125,000	22,000	BB
608 2RS / C3	8,000	22,000	7,000	BB
6201 2RS	12,000	32,000	10,000	BB
6201 ZZ / C3	12,000	32,000	10,000	BB
6203 ZZ / C3	17,000	40,000	12,000	BB
6204 ZZ / C3	20,000	47,000	14,000	BB
6205 ZZ / C3	25,000	52,000	15,000	BB
6207 2RS / C3	35,000	72,000	17,000	BB
6208 2RS / C3	40,000	80,000	18,000	BB
6210 ZZ NR	50,000	90,000	20,000	BB
6300 2RS / C3	10,000	35,000	11,000	BB
6301 2RS / C3	12,000	37,000	12,000	BB
6302 ZZ / C3	15,000	42,000	13,000	BB
6303 2RS / C3	17,000	47,000	14,000	BB
6304 ZZ / C3	20,000	52,000	15,000	BB
6305 2RS / C3	25,000	62,000	17,000	BB
6305 ZZ / C3	25,000	62,000	17,000	BB
6306	30,000	72,000	19,000	BB
6306 2RS / C3	30,000	72,000	19,000	BB
6306 D25 2RS / C3	25,000	72,000	19,000	BB
6306 ZZ / C3	30,000	72,000	19,000	BB
6307 2RS / C3	35,000	80,000	21,000	BB
7210 B	50,000	90,000	20,000	BB
A 6075 / A 6157	19,050	39,992	12,014	TRB
F 15044	35,000	65,000	35,000	TRBDR
F 15058	63,500	105,000	23,000	TRBS
F 15067	29,000	53,000	37,000	TRBDR
F 15097	68,000	127,000	115,000	HWT
F 15139	60,000	96,500	29,700	BBS
F 15140	60,000	96,500	25,700	BBS
F 15141	55,000	91,500	25,000	BBS















Fersa®	Dimensions / Dimensões / Dimensiones			
	d	D	T	
F 15151	27,000	52,000	45,0 / 50,0	TRBDR
F 15165	109,538	158,700	23,020	TRBS
F 15183	65,000	165,000	36,000	TRBS
F 16021	35,000	65,000	35,000	BBDRAC
F 16029	37,000	72,000	33,000	BBDRAC
F 16030	37,000	72,000	37,000	BBDRAC
F 16035	39,000	68,000	37,000	BBDRAC
F 16044	39,980	108,000	32,000	BBDRAC
F 16048	42,000	82,000	36,000	BBDRAC
F 16051	42,000	84,030	39,000	BBDRAC
F 16097	35,000	50,000	20,000	BBDRAC
F 16098	30,000	55,000	23,000	BBDRAC
F 16099	35,000	50,000	20,000	BBDRAC
F 16100	35,000	55,000	20,000	BBDRAC
F 16101	35,000	52,000	22,000	BBDRAC
F 16102	40,000	62,000	24,000	BBDRAC
F 16103	40,000	62,000	20,625	BBDRAC
F 16104	30,000	62,000	27,000	BBDRAC
F 18018	25,000	62,020	24,000	BBS
F 18031	63,500	102,000	20,570	BBS
F 18039	36,513	68,000	15,000	BBS
F 18040	63,500	100,000	23,000	BBS
F 18041	50,000	90,000	20,000	BBS
F 19002	45,000	100,000	25,000	CRBS
F 19008	80,000	150,000	28,000	CRBS
F 19009	60,000	130,000	31,000	CRBS
F 19012	35,000	80,000	23,000	CRBS
F 19016	63,000	97,450	34,750	CRBS
F 19020	35,000	80,000	22,000	CRBS
F 19029	25,000	52,000	21,000	CRBS
F 19042	60,000	110,000	28,000	CRBS
F 19048	36,000	56,300	20,000	CRBS
F 19075	30,000	110,000	32,300	CRBS
HM 903249 / HM 903210w	44,450	95,250	30,958	TRB
JF 6049 / JF 6010	60,000	115,000	40,000	TRB
JL 819349 / JL 819310	95,000	135,000	20,000	TRB
JLM 104948 / JLM 104910	50,000	82,000	21,500	TRB
JLM 506849 A / JLM 506811	55,000	90,000	25,000	TRB
JM 205149 / JM 205110	50,000	90,000	28,000	TRB
JP 12049 A / JP 12010	120,000	170,000	27,000	TRB
JW 7049 / JW 7010	70,000	140,000	39,000	TRB
L 44643 / L 44610	25,400	50,292	14,224	TRB
N 307 FM	35,000	80,000	21,000	CRB
NJ 309 FM	45,000	100,000	25,000	CRB
NU 1011 FM	55,000	90,000	18,000	CRB
NU 209 FMN / C3	45,000	85,000	190,000	CRB
NU 310 FM	50,000	110,000	27,000	CRB
NUP 309 FM	45,000	100,000	25,000	CRB
NUP 310 FM / C3	50,000	110,000	27,000	CRB
QJ 209 FM	45,000	85,000	19,000	BB4PAC
RMS 9 2RS / C4	28,575	71,438	20,638	BB









Application by Fersa Reference







Aplicação por Referência Fersa











Aplicación por Referência Fersa













10.7







Fersa®			Brand / Marca / Marca	Model / Modelo / Modelo	Application / Aplicação / Aplicaciones
11 BC	TRB	References Fersa with Multiple Applications / Referências Fersa com Múltiplas Aplicações / Referencias Fersa con Multiples Aplicaciones			
11590 / 11520	TRB		FORD	F 75	Eixo Dianteiro / Eje Delantero / Front Axle
				Jeep	
				Jeep Willys (4X2 * 4X4) (60...83)	
				Rural	
				Rural (4X2 * 4X4)	
12168 / 12303	TRB		DINA	311 * 312 * 314 * 362 * 315G * 316G * 317G6 * 318G * 319G * 321C * 323G	Direção / Dirección / Steering
12175 / 12303	TRB		DINA	311 * 312 * 314 * 362 * 315G * 316G * 317G6 * 318G * 319G * 321C * 323G	Direção / Dirección / Steering
1380 / 1328	TRB		DODGE	400 * 450 * 700 * 750 * 900 * 950	Eixo Dianteiro / Eje Delantero / Front Axle
14116 / 14276	TRB		CHRYSLER	D-600 * PD-600	Eixo Dianteiro / Eje Delantero / Front Axle
14131 / 14276	TRB		FORD	F 75	Caixa de transferência / Caja de Transferencia / Transfer Case
				Jeep Willys (4X2 * 4X4) (60...83)	
				Rural (4X2 * 4X4)	
14585 / 14525	TRB	References Fersa with Multiple Applications / Referências Fersa com Múltiplas Aplicações / Referencias Fersa con Multiples Aplicaciones			
15101 / 15245	TRB		FORD	F-350 * P-350	Eixo Dianteiro / Eje Delantero / Front Axle
				F-350 Super Duty	
				F-450 * F-450 Super Duty	
				F-550 Super Duty	
			DODGE	D350	
				Ram 2500	
				Ram Charger	
				Ram Van * Wagon 2500	
				Ram Van * Wagon 3500	
FORD	F 250				
	F 350				
	Microbus				
15103 S / 15243	TRB		GENERAL MOTORS	C 3500	
			GENERAL MOTORS	P 30	
			GENERAL MOTORS	C-3500	
15106 / 15250 X	TRB		AGRALE	CHASSI MA 8.5E-TRONIC * MA 9.2E-TRONIC * MA 9.2 GREEN E-TRONIC * MA 7.9E-MEC	Eixo Dianteiro / Eje Delantero / Front Axle
			AGRALE	6000E-MEC * 6000E-TRONIC FURGOVAN * 8000E-MEC FURGOVAN * 8500E-MEC * 8500CD-EMEC * 8500E-TRONIC	
			DODGE	400 * 450 * 700 * 750 * 900 * 950	
			FORD	Cargo 814	
				Cargo 815 * 815 E	
				F 100 (61...80 Diesel) * F 600 (56...77 Gas.) * F 700 (77...80) * F 750 (72...77) * 750 * 2000 * 4000	
			GENERAL MOTORS	A-C-D 60* 70* 80* 90* 99 Turbo e 3500 Heavy Duty	
			VOLKSWAGEN	5-140E Delivery * 5-140 EOD Volksbus	
				6-80 * 6-90 * 6-90 (P*S)	
				7-90 S * 7-100 * 7-110 S	
	VOLKSWAGEN	8-100 * 8-140 (CO * CE) * 8-120 * 8-120 OD *			
		8-150 (E * EOD * OD) * 9-150 (EOD * OD)			
			8-150		
17887 / 17831	TRB	References Fersa with Multiple Applications / Referências Fersa com Múltiplas Aplicações / Referencias Fersa con Multiples Aplicaciones			



Fersa®			Brand / Marca / Marca	Model / Modelo / Modelo	Application / Aplicação / Aplicaciones
25577 / 25523	TRB		FORD	F 1000 (79...)	Diferencial / Diferencial / Differential
				F 75	
				Jeep Willys (4X2 * 4X4) (60...83)	
				Rural (4X2 * 4X4)	
25580 / 25520	TRB		FREIGHTLINER	FL 60	Caixa de Mudanças / Caja de Cambios / Gearbox
				FL 70	
				FS 65	
			GENERAL MOTORS	Kodiak	
INTERNATIONAL	4200 VT 365 * 4300 DT 466 / 195 HP				
25581 / 25520	TRB		VOLKSWAGEN	7-100 * 8-120 * 8-140 (CE*CO) * 8-150 * 9-150 OD	Caixa de Mudanças / Caja de Cambios / Gearbox
			FORD	Cargo 814	
			VOLKSWAGEN	13-130 * 13-150 * 13-170 * 13-180E * 13-190 (77...)E * 13-210	
				6-80 * 6-90 * 6-90 (P*S)	
25590 / 25520	TRB		CHRYSLER	D-600 * PD-600	Caixa de Mudanças / Caja de Cambios / Gearbox Eixo Dianteiro / Eje Delantero / Front Axle
				Ram 6500	
			DINA	531 K * 532 J	
			FORD	F-600 * B-600	
			FREIGHTLINER	FL 60	
				FL 70	
				FS 65	
				MT45 * MT45A. M2 52K 6X2	
			GENERAL MOTORS	Kodiak	
			INTERNATIONAL	4200 VT 365 * 4300 DT 466 / 195 HP	
			MERCEDES BENZ	L1113 * L1114 * L1116 * L1117 * L1118	
				L1313 * L1314 * L1315 * L1316 * L1317 * L1318 * L1319 * L1321	
				L1417 52	
				L1518 52	
				L1617 59	
				L2121 54	
				LK1417 34	
				LK1418 39 * LK1418 52	
		MBO 1018 44			
		MBO 1019 44 Boxer			
		MBO 1219 52 Boxer			
		OMC 1419 51			
		LK 1313 * LK 1314 * LK 1315 * LK 1316 * LK 1317 * LK 1318 * LK 1319 * LK 1320 * LK 1321			
			DINA	455 OF	
541 * 542					
555 OF					
MERCEDES BENZ	MBO 1018 44				
	MBO 1019 44 Boxer				
	MBO 1219 52 Boxer				
OMC 1419 51					







Fersa®			Brand / Marca / Marca	Model / Modelo / Modelo	Application / Aplicação / Aplicaciones
25590 / 25522	TRB		AGRALE	CHASSI MA 8.5E-TRONIC * MA 9.2E-TRONIC * MA 9.2 GREEN E-TRONIC * MA 7.9E-MEC	Eixo Dianteiro / Eje Delantero / Front Axle
			INTERNATIONAL	3000 RE	
			MERCEDES BENZ	O500M 1728 * O500R 1735	Caixa de Mudanças / Caja de Cambios / Gearbox
			VOLKSWAGEN	OMC 1628 58 Andare	
			VOLVO	8-100 * 8-140 (CO * CE) * 8-120 * 8-120 OD * 8-150 (E * EOD * OD) * 9-150 (EOD * OD)	Eixo Dianteiro / Eje Delantero / Front Axle
		AGRALE	6000E-MEC * 6000E-TRONIC FURGOVAN * 8000E-MEC FURGOVAN * 8500E-MEC * 8500CD-EMEC * 8500E-TRONIC	Eixo Dianteiro / Eje Delantero / Front Axle	
		DINA	9200E-TRONIC		
		DODGE	D9 160 * D12 160 Cab Over	Caixa de Mudanças / Caja de Cambios / Gearbox	
		DODGE	400 * 450 * 700 * 750 * 900 * 950	Eixo Dianteiro / Eje Delantero / Front Axle	
		FORD	Cargo 1415 * 1416 Cargo 1422 * 1514 * 1517 * 1517E * 1615 * 1615T * 1617 * 1618 * 1618T * 1619 * 1621 * 1622 * 1717E * 1722 * 1722E * 2216 * 2217 * 2218 * 2218T * 2319 * 2322 * 2324 * 2422 * 2422E * 2425 * 2428E * 2630 * 3224 * 3530 * 4030	Caixa de Mudanças / Caja de Cambios / Gearbox	
		FORD	Cargo 814 Cargo 815 * 815 E	Eixo Dianteiro / Eje Delantero / Front Axle	
		FORD	F 100 (61...80 Diesel) * F 600 (56...77 Gas.) * F 700 (77...80) * F 750 (72...77) * 750 * 2000 * 4000		
		FORD	F-800		
		FREIGHTLINER	FL 80 * FL 80 QR 4X2	Caixa de Mudanças / Caja de Cambios / Gearbox	
		FREIGHTLINER	FS 65		
		FREIGHTLINER	MT45 * MT45A. M2 52K 6X2		
		GENERAL MOTORS	6-100 (4X2)* 6-150* 12-170 L*S (4X2)* 14-190 (77...) (4X2)* 15-190 (77...) (4X2)* 16-220 (4X2)	Caixa de Mudanças / Caja de Cambios / Gearbox	
		GENERAL MOTORS	A-C-D 60* 70* 80* 90* 99 Turbo e 3500 Heavy Duty	Eixo Dianteiro / Eje Delantero / Front Axle	
		GENERAL MOTORS	Kodiak		
		INTERNATIONAL	4200 VT 365 * 4300 DT 466 / 195 HP		
		INTERNATIONAL	4400-215HP 4X2 * 4400-250HP * 4400-285HP * 4400-300HP		
		INTERNATIONAL	4700 (4X2)* 4900 (16 ton.)		
		KENWORTH	T300 4X2 * 6X4		
		MERCEDAS BENZ	L1214 * L1215 * L1217 39 * L1217 52 * L1218 52	Caixa de Mudanças / Caja de Cambios / Gearbox	
		MERCEDAS BENZ	MBO 1018 44		
		MERCEDAS BENZ	MBO 1019 44 Boxer		
		MERCEDAS BENZ	MBO 1219 52 Boxer		
		MERCEDAS BENZ	MBO 1418 60		
		MERCEDAS BENZ	MBO 1419 60 Boxer		
		MERCEDAS BENZ	OMC 1419 51		
		MERCEDAS BENZ	OMC 1423 51 Torino		
		MERCEDAS BENZ	OMC 1425 51 Allegro		
		VOLKSWAGEN	5-140E Delivery * 5-140 EOD Volksbus	Eixo Dianteiro / Eje Delantero / Front Axle	
		VOLKSWAGEN	6-80 * 6-90 * 6-90 (P*S)		
		VOLKSWAGEN	7-90 S * 7-100 * 7-110 S		
			MERCEDAS BENZ	MBO 1018 44 MBO 1019 44 Boxer MBO 1217 MBO 1219 52 Boxer MBO 1418 60 MBO 1419 60 Boxer OMC 1419 51 OMC 1425 51 Allegro	Caixa de Mudanças / Caja de Cambios / Gearbox
			AGCO MAXION	Roçadeira MF 880	Motor / Motor / Engine
			VOLKSWAGEN	D 1400 TD * Volksbus E 13 * E 21	Caixa de Mudanças / Caja de Cambios / Gearbox







Fersa®			Brand / Marca / Marca	Model / Modelo / Modelo	Application / Aplicação / Aplicaciones	
25877 / 25820	TRB		DINA	434 17570 Shuttle Bus Citrus 11000 * 9500	Eixo Dianteiro / Eje Delantero / Front Axle	
			DINA	D9 160 * D12 160 Cab Over		
			FREIGHTLINER	FL 60 MT45 * MT45A. M2 52K 6X2		
			MERCEDES BENZ	MBO 1017		MBO 1018 44
				MBO 1019 44 Boxer		
				DINA		451
			MERCEDES BENZ	DINA		433 16070 455 OF
				MBO 1017		MBO 1018 44
				MBO 1019 44 Boxer		
		25877 / 25821	TRB			AGRALE
FORD	Cargo 1113 * 1114 * 1116 * 1117				Caixa de Mudanças / Caja de Cambios / Gearbox	
	Cargo 1215					
	Cargo 1313 * 1314 * 1317 * 1317E					
	Cargo 1415 * 1416					
	Cargo 1422 * 1514 * 1517 * 1517E * 1615 * 1615T * 1617 * 1618 * 1618T * 1619 * 1621 * 1622 * 1717E * 1722 * 1722E * 2216 * 2217 * 2218 * 2218T * 2319 * 2322 * 2324 * 2422 * 2422E * 2425 * 2428E * 2630 * 3224 * 3530 * 4030					
Cargo 814						
GENERAL MOTORS	6-100 (4X2)* 6-150* 12-170 L*S (4X2)* 14-190 (77...) (4X2)* 15-190 (77...) (4X2)* 16-220 (4X2)				Caixa de Mudanças / Caja de Cambios / Gearbox	
	6-100 (4X2)* 6-150* 12-170 L*S (4X2)* 14-190 (77...) (4X2)* 15-190 (77...) (4X2)* 16-220 (4X2)					
VOLKSWAGEN	13-130 * 13-150 * 13-170 * 13-180E * 13-190 (77...)E * 13-210 6-80 * 6-90 * 6-90 (P*S)					
	VOLKSWAGEN	7-100 * 8-120 * 8-140 (CE*CO) * 8-150 * 9-150 OD				
25880 / 25820	TRB		DINA	400 Serie	Eixo Dianteiro / Eje Delantero / Front Axle	
			FORD	F-600 * B-600		
			DINA	400		
				451 431K * 432K * 432J * 432J1 * 432J2		
2689 / 2631	TRB		AGRALE	7500	Caixa de Mudanças / Caja de Cambios / Gearbox	
2780 / 2720	TRB		CHRYSLER	D-600 * PD-600	Eixo Dianteiro / Eje Delantero / Front Axle	
			DODGE	1400 TD		
				400 * 450 * 700 * 750 * 900 * 950		
			FORD	F 100 (61...80 Diesel) * F 600 (56...77 Gas.) * F 700 (77...80) * F 750 (72...77) * 750 * 2000 * 4000		
				F 11000 * F 12000		
				F 19000 (77...) * F 21000 * F 22000		
			GENERAL MOTORS	F 7000 * FT 7000 e FT 8000 (77...80); F 8000 e F 8500 (77...79) * FT 8500		Caixa de Redução / Caja de Reducción / Reduction Box
				6-100 (4X2)* 6-150* 12-170 L*S (4X2)* 14-190 (77...) (4X2)* 15-190 (77...) (4X2)* 16-220 (4X2)		
		VOLKSWAGEN	A-C-D 60* 70* 80* 90* 99 Turbo e 3500 Heavy Duty			
			E 13 * E 21			
	MARCHESAN	Grade Aradora Controle Remoto Offset				
		Grade Aradora Pesada com Pneus GAPCW				
		Grade Aradora Super Pesada com Pneus GASPCW				













Fersa®			Brand / Marca / Marca	Model / Modelo / Modelo	Application / Aplicação / Aplicaciones		
2789 / 2720	TRB		MERCEDES BENZ	1418 OH * 1419 OH * 1420 (OH*OHL) * 1421 OHL	Caixa de Mudanças / Caja de Cambios / Gearbox		
				OH 1417 * OH 1418			
				OH 1419 * OH 1420 * OH 1421			
			MERCEDES BENZ	1214 C * 1214 K * 1214 (L*LK*LS) * 1215 * 1215 C * 1215 (L*LA*LK) * 1218 * 1218 R (L)			
				1215 OF * 1217 OF			
				1414 * 1414 (K*L*LA*LAK*LK) * 1418 * 1418 (E*K*R) * 1418 (L*LA*LAK*LK*R(LK)) * 1419 (L*LK*LS) * 1420 (L*LK*LS)			
				1417 OF * 1419 OF * 1421 OF			
			MERCEDES BENZ	1421 OMC			
				1215 OF * 1217 OF			
				1417 OF * 1419 OF * 1421 OF			
			GENERAL MOTORS	1421 OMC			
				A-C-D (10*14*15*20*40) * Bonanza * Veraneio * D1000			
			S 10 * Blazer				
28682 / 28622	TRB		DODGE	Ram 2500	Eixo Traseiro / Eje Trasero / Rear Axle		
28985 / 28921	TRB	References Fersa with Multiple Applications / Referências Fersa com Múltiplas Aplicações / Referencias Fersa con Múltiples Aplicaciones					
29675 / 29630	TRB		DINA	761	Eixo Traseiro / Eje Trasero / Rear Axle		
			INTERNATIONAL	4400-215HP 4X2 * 4400-250HP * 4400-285HP * 4400-300HP			
29685 / 29620	TRB		JOHN DEERE	Diversos	Eixo / Eje / Axle		
32020 XF	TRB		FNH	Diversos	Embreagem / Embrague / Clutch		
30203 F	TRB		MERCEDES BENZ	1113 (LPO*OH) * 1114 LPO * 1115 L (OH) * 1118 LPO	Motor / Motor / Engine		
				1313 OH * 1314 OH * 1315 OH * 1316 (OH*OHL) * 1316 G (OH*OHL) * 1317 OH * 1318 OH * 1319 OH * 1320 (OH*OHL)			
				1418 OH * 1419 OH * 1420 (OH*OHL) * 1421 OHL			
				1517 OH * 1518 OH * 1519 OH * 1520 OH * 1521 OH			
				1721 L (OH)			
				321 H (O) * 321 HL (O) (58...71)			
				326 O			
				352 HL (O) (...74)			
				355 O			
				362 O			
				364 O			
				370 RS*RSD*RST* ST*U*UP (O) * 371 RS*RSD*RST* ST*U*UP (O)			
				608 D * E (L*LO) * 708 D * E (L*LO) * 709 L * 710 L * 712 L			
				VOLKSWAGEN		15 - 210	Direção / Dirección / Steering
						22-140 * 22-210 * 23-210 * 23-220 * 23-250 E * 23-310 TITAN	Motor / Motor / Engine
		23-250					
		FIAT	4 - 140210	Direção / Dirección / Steering			
			180 C * C3 * L * N * N3 (71...)				
			FNM 210 C * CM * LN (71...76)				
		FORD	FNM V-15 (69...74)				
			Cargo 1113 * 1114 * 1116 * 1117				
			Cargo 1215				
			MERCEDES BENZ	Cargo 1313 * 1314 * 1317 * 1317E	Motor / Motor / Engine		
				Cargo 1415 * 1416			
				Cargo 1422 * 1514 * 1517 * 1517E * 1615 * 1615T * 1617 * 1618 * 1618T * 1619 * 1621 * 1622 * 1717E * 1722 * 1722E * 2216 * 2217 * 2218 * 2218T * 2319 * 2322 * 2324 * 2422 * 2422E * 2425 * 2428E * 2630 * 3224 * 3530 * 4030			
				608 (L*LO) * 708 (L*LO) * 809 (LO*OF) * 812 (LO*OF) * 814 LO * 817 O * 914 LO * 709 * 710 * 712 * 712 C * 811 * 911 L * 912 * 913 * 914 * 914 C * 917			
				1113 (L*LA*LAK*LAS*LK*LP*LS*LP) * 1114 * 1114 (L*LK*LP) * 1116 (L*LA*LAK*LAS*LB* LK*LS) * 1118 (L*LK*LP)			
				1113 OF * 1115 OF			
				1214 C * 1214 K * 1214 (L*LK*LS) * 1215 * 1215 C * 1215 (L*LA*LK) * 1218 * 1218 R (L)			
				1215 OF * 1217 OF			





Fersa®			Brand / Marca / Marca	Model / Modelo / Modelo	Application / Aplicação / Aplicaciones
30203 F	TRB		MERCEDES BENZ	1313 (L*LA*LAK*LB*LK*LS) * 1314 (L*LA*LAK*LB*LK*LS) * 1316 (L*LA*LAK*LAS*LB*LK*LS) * 1317 (L*LA*LAK*LK*LS)* 1319 (L)	Motor / Motor / Engine
				1313 OF * 1314 OF * 1315 OF * 1316 OF * 1317 OF * 1318 OF * 1319 OF * 1320 OF	
				1414 * 1414 (K*L*LA*LAK*LK) * 1418 * 1418 (E*K*R) * 1418 (L*LA*LAK*LK*R(LK)) * 1419 (L*LK*LS) * 1420 (L*LK*LS)	
				1417 OF * 1419 OF * 1421 OF	
				1421 OMC	
				1513 (L*LA*LAK*LB*LG*LK*LS) * 1514 (L*LK*LS) * 1516 (L*LA*LAK*LB*LG*LK*LS) * 1517 (L*LK) * 1518 (L*LK*LS) * 1519 (L*LAK*LB*LG*LK*LS) * 1520 (L*LK*LP*LPK*LPS*LS) * 1521 L * 1524 e 1525 (L*LK*LS)	
				1517 OF * 1518 OF * 1520 OF	
				1614 * 1615 (L*LK*LS) * 1615 * 1618 M * 1618 (L*LK*LS) * 1619 (L)	
				1618 OF	
				1714 OF * 1721 OF * 1722 OF	
				1714 * 1714 (L*K*LK) * 1715 * 1718 * 1718 (A * AK) * K * 1720 L * 1721 * 1721 S * 1721 (L*LK) * 1722 S * 1723 * 1723 S * 1725 L	
				2013 (L*LA*LAK*LB*LG*LK*LS) * 2013 6X2 (L) * 2014 (L*LB*LK) * 2016 (LB*LK) * 2017 (L*LB*LK)	
				2213 (L*LB*LK*LS) * 2213 6X6 (LA) * 2214 * 2215 (L*LB*LK*LS) * 2216 (L*LA*LAK*LB*LG*LK*LS) * 2217 (L*LB*LK*LS) * 2219 (L*LA*LAK*LB*LG*LK*LS) * 2220 * 2222 * 2225 (L*LB*LK*LS)	
				2314 (L*LB*LK*LS) * 2318 (L*LB*LK*LS) * 2325 (L*LB*LK*LS)	
				2414 (6X4) * 2414 (L) * 2418 (L*LB*LK) * 2420 (L*LB*LK) * 2423 B 6X4 * 2423 K 6X4 * 2425 6X6 (LA) * 2425 (L*LB*LK) * 2428 6X4	
				VOLKSWAGEN	
		12-140 * 12-140 H * 12-140 T * 12-170 BT			
		14-140 * 14-150 * 14-170 BT * 14-180 * 14-200 * 14-210 * 14-220			
		15-170 * 15-170E * 15-180 * 15-180E * 15-180 OD * 15-190 (77...) * 15-190 (77...)EOD			
		16-170 * 16-180 * 16-200 * 16-210 * 16-220 CO * 16300			
			MERCEDES BENZ	1113 OF * 1115 OF	Motor / Motor / Engine
				1215 OF * 1217 OF	
				1313 OF * 1314 OF * 1315 OF * 1316 OF * 1317 OF * 1318 OF * 1319 OF * 1320 OF	
				1417 OF * 1419 OF * 1421 OF	
				1421 OMC	
				1517 OF * 1518 OF * 1520 OF	
				1618 OF	
		1714 OF * 1721 OF * 1722 OF			
	AGRALE	Tratores 4100 * 4200 * 4300 * T145 * T146 * T415 * T420	Câmbio / Caja de Cambios / Gearbox		
		2070 * 2080 * 2100 * 2105 (4x2) * 2400 * 2400 (4x4) * 2500 * 2600	Eixo Dianteiro / Eje Delantero / Front Axle		
	CBT	2070 * 2080 * 2100 * 2105 (4x2) * 2400 * 2400 (4x4) * 2500 * 2600	Câmbio / Caja de Cambios / Gearbox		
		Tratores 1000 * 1000 (4x4) * 1020 * 1020 (4x4) * 1065 * 1065 (4x4) * 1090 * 1105	Motor / Motor / Engine		
	FNH	Tratores 4600 * 4610 * 4630 * 5600 * 5610 * 5630 * 6600 * 6610 * 6630 * 7610 * 7630 * 7810 * 7830 * 8030 * 8BR			
VALTRA - VALMET	Tratores 685 * 685C (4x4) * 785 * 785C (4x4) * 880 Cafeeiro * 880 (4x4) * 885 * 980 (4x4) * 985 * 985F * 1180 * 1184				
	FORD	Belina I (...78) * Corcel I (...78)	Câmbio / Caja de Cambios / Gearbox		
		Belina II (79...) * Corcel II (79...)			
		Del Rey * Pampa			









Fersa®			Brand / Marca / Marca	Model / Modelo / Modelo	Application / Aplicação / Aplicaciones
30204 F	TRB		MERCEDES BENZ	1313 OH * 1314 OH * 1315 OH * 1316 (OH*OHL) * 1316 G (OH*OHL) * 1317 OH * 1318 OH * 1319 OH * 1320 (OH*OHL)	Motor / Motor / Engine
				1418 OH * 1419 OH * 1420 (OH*OHL) * 1421 OHL	
				1517 OH * 1518 OH * 1519 OH * 1520 OH * 1521 OH	
				1721 L (OH)	
				321 H (O) * 321 HL (O) (58...71)	
				326 O	
				352 HL (O) (...74)	
				355 O	
				362 O	
				364 O	
			370 RS*RSD*RST* ST*U*UP (O) * 371 RS*RSD*RST* ST* U*UP (O)		
			608 D * E (L*LO) * 708 D * E (L*LO) * 709 L * 710 L * 712 L		
			O 371 R * O 371 RS * O 371 RSD		
			O 371 U * O 371 UL * O 371 UP		
			22-140 * 22-210 * 23-210 * 23-220 * 23-250 E * 23-310 TITAN		
			VOLKSWAGEN	23-250	
			FIAT	180 C * C3 * L * N * N3 (71...)	
				70 (77...) * 80	
				FNM 210 C * CM * LN (71...76)	
				FNM V-15 (69...74)	
		Cargo 1113 * 1114 * 1116 * 1117			
		Cargo 1215			
		Cargo 1313 * 1314 * 1317 * 1317E			
		Cargo 1415 * 1416			
		Cargo 1422 * 1514 * 1517 * 1517E * 1615 * 1615T * 1617 * 1618 * 1618T * 1619 * 1621 * 1622 * 1717E * 1722 * 1722E * 2216 * 2217 * 2218 * 2218T * 2319 * 2322 * 2324 * 2422 * 2422E * 2425 * 2428E * 2630 * 3224 * 3530 * 4030			
		Cargo 1422 * 1514 * 1517 * 1517E * 1615 * 1615T * 1617 * 1618 * 1618T * 1619 * 1621 * 1622 * 1717E * 1722 * 1722E * 2216 * 2217 * 2218 * 2218T * 2319 * 2322 * 2324 * 2422 * 2422E * 2425 * 2428E * 2630 * 3224 * 3530 * 4030			
		FORD	608 (L*LO) * 708 (L*LO) * 809 (LO*OF) * 812 (LO*OF) * 814 LO * 817 O * 914 LO * 709 * 710 * 712 * 712 C * 811 * 911 L * 912 * 913 * 914 * 914 C * 917		
			1214 C * 1214 K * 1214 (L*LK*LS) * 1215 * 1215 C * 1215 (L*LA*LK) * 1218 * 1218 R (L)		
			1215 OF * 1217 OF		
			1313 (L*LA*LAK*LB*LK*LS) * 1314 (L*LA*LAK*LB*LK*LS) * 1316 (L*LA*LAK*LB*LK*LS) * 1317 (L*LA*LAK*LB*LK*LS) * 1319 (L)		
			1313 OF * 1314 OF * 1315 OF * 1316 OF * 1317 OF * 1318 OF * 1319 OF * 1320 OF		
			1414 * 1414 (K*L*LA*LAK*LK) * 1418 * 1418 (E*K*R) * 1418 (L*LA*LAK*LK*R(LK)) * 1419 (L*LK*LS) * 1420 (L*LK*LS)		
			1417 OF * 1419 OF * 1421 OF		
			1421 OMC		
			1513 (L*LA*LAK*LB*LG*LK*LS) * 1514 (L*LK*LS) * 1516 (L*LA*LAK*LB*LG*LK*LS) * 1517 (L*LK) * 1518 (L*LK*LS) * 1519 (L*LAK*LB*LG*LK*LS) * 1520 (L*LK*LP*LPK*LPS*LS) * 1521 L * 1524 e 1525 (L*LK*LS)		
			1517 OF * 1518 OF * 1520 OF		
		1614 * 1615 (L*LK*LS) * 1615 * 1618 M * 1618 (L*LK*LS) * 1619 (L)			
		1618 OF			
		1714 OF * 1721 OF * 1722 OF			
		1714 * 1714 (L*K*LK) * 1715 * 1718 * 1718 (A * AK) * K * 1720 L * 1721 * 1721 S * 1721 (L*LK) * 1722 S * 1723 * 1723 S * 1725 L			
		2013 (L*LA*LAK*LB*LG*LK*LS) * 2013 6X2 (L) * 2014 (L*LB*LK) * 2016 (LB*LK) * 2017 (L*LB*LK)			
		2213 (L*LB*LK*LS) * 2213 6X6 (LA) * 2214 * 2215 (L*LB*LK*LS) * 2216 (L*LA*LAK*LB*LG*LK*LS) * 2217 (L*LB*LK*LS) * 2219 (L*LA*LAK*LB*LG*LK*LS) * 2220 * 2222 * 2225 (L*LB*LK*LS)			
		2314 (L*LB*LK*LS) * 2318 (L*LB*LK*LS) * 2325 (L*LB*LK*LS)			
		2414 (6X4) * 2414 (L) * 2418 (L*LB*LK) * 2420 (L*LB*LK) * 2423 B 6X4 * 2423 K 6X4 * 2425 6X6 (LA) * 2425 (L*LB*LK) * 2428 6X4			
		331 (L*LPK*LPS) 60...68			
		11-130 * 11-140 * 11-160			
		12-140 * 12-140 H * 12-140 T * 12-170 BT			
		14-140 * 14-150 * 14-170 BT * 14-180 * 14-200 * 14-210 * 14-220			
		15-170 * 15-170E * 15-180 * 15-180E * 15-180 OD * 15-190 (77...) * 15-190 (77...)EOD			
		16-170 * 16-180 * 16-200 * 16-210 * 16-220 CO * 16300			
		VOLKSWAGEN			











Fersa®			Brand / Marca / Marca	Model / Modelo / Modelo	Application / Aplicação / Aplicaciones
30204 F	TRB		MERCEDES BENZ	1215 OF * 1217 OF	Motor / Motor / Engine
				1313 OF * 1314 OF * 1315 OF * 1316 OF * 1317 OF * 1318 OF * 1319 OF * 1320 OF	
				1417 OF * 1419 OF * 1421 OF	
				1421 OMC	
				1517 OF * 1518 OF * 1520 OF	
				1618 OF	
				1714 OF * 1721 OF * 1722 OF	
				2070 * 2080 * 2100 * 2105 (4x2) * 2400 * 2400 (4x4) * 2500 * 2600	
		CBT	Tratores 1000 * 1000 (4x4) * 1020 * 1020 (4x4) * 1065 * 1065 (4x4) * 1090 * 1105		
			JOHN DEERE	Colheitadeiras CA1165 * CA1175 * CA1185 * CA1450 * CA1550-02 * CA1550-03	Unidade de Separação e Limpeza / Unidad de Separación y Limpeza / Separation and Cleaning Unit
			MARCHESAN	Cobertura para Plantio Direto CPD * CPD2	Eixo Traseiro / Eje Trasero / Rear Axle
				Plantadeira Direta de Cereais * Pastagem PDCP	Caixa de Redução / Caja de Reducción / Reduction Box
				Plantadeira Hidráulica Tatu PHT * PHT Suprema	
				Plantadeira Ultra Flex * Ultra Flex Suprema	Caixa de Distribuição / Caja de Distribución / Distribution Box
				Semeadeira Direta Articulada SDA 3	
		Semeadeira Direta Articulada SDA 3			
		VALTRA - VALMET	Tratores 60 * 60 ID * 62 * 65 * 65 Cafeeiro * 68 * 68 Cafeeiro * 78 * 80 * M80 * 85 * 85ID * 86 * 86 ID * 88 * 88 ID	Motor / Motor / Engine	
			Tratores 685 * 685C (4x4) * 785 * 785C (4x4) * 880 Cafeeiro * 880 (4x4) * 885 * 980 (4x4) * 985 * 985F * 1180 * 1184		
	PONTIAC	Matiz	Eixo Traseiro / Eje Trasero / Rear Axle		
30205 F	TRB		MERCEDES BENZ	1113 (LPO*OH) * 1114 LPO * 1115 L (OH) * 1118 LPO	Direção / Dirección / Steering
				1313 OH * 1314 OH * 1315 OH * 1316 (OH*OHL) * 1316 G (OH*OHL) * 1317 OH * 1318 OH * 1319 OH * 1320 (OH*OHL)	Motor / Motor / Engine
				1418 OH * 1419 OH * 1420 (OH*OHL) * 1421 OHL	Direção / Dirección / Steering
				1517 OH * 1518 OH * 1519 OH * 1520 OH * 1521 OH	Motor / Motor / Engine
				1621 L (OH) * 1623 LG (OH) * 1625 (OH) * 1625 L (OH) * 1628 L (OH) * 1630L (OH) * 1635 (OH) * 1636 L (OH)	Direção / Dirección / Steering
				321 H (O) * 321 HL (O) (58...71)	Motor / Motor / Engine
				326 O	Direção / Dirección / Steering
				352 HL (O) (...74)	Motor / Motor / Engine
				355 O	
				360 HL (O) (...74)	Direção / Dirección / Steering
				362 O	
				364 O	
				370 RS*RSD*RST* ST*U*UP (O) * 371 RS*RSD*RST* ST*U*UP (O)	
				400 (R * RS * RSD * RSL) (O)	
				O 370 R * O 370 RS * O 370 RSD	
		1113 (L*LA*LAK*LAS*LK*LP*LS*LP) * 1114 * 1114 (L*LK*LP) * 1116 (L*LA*LAK*LAS*LB*LK*LS) * 1118 (L*LK*LP)	Motor / Motor / Engine		
		1113 OF * 1115 OF			
		1313 (L*LA*LAK*LB*LK*LS) * 1314 (L*LA*LAK*LB*LK*LS) * 1316 (L*LA*LAK*LAS*LB*LK*LS) * 1317 (L*LA*LAK*LB*LK*LS) * 1319 (L)			
		1313 OF * 1314 OF * 1315 OF * 1316 OF * 1317 OF * 1318 OF * 1319 OF * 1320 OF			
		1414 * 1414 (K*L*LA*LAK*LK) * 1418 * 1418 (E*K*R) * 1418 (L*LA*LAK*LK*R(LK)) * 1419 (L*LK*LS) * 1420 (L*LK*LS)			
		MERCEDES BENZ	1417 OF * 1419 OF * 1421 OF	Direção / Dirección / Steering	
				Motor / Motor / Engine	













Fersa®			Brand / Marca / Marca	Model / Modelo / Modelo	Application / Aplicação / Aplicaciones		
30205 F	TRB		MERCEDES BENZ	1421 OMC	Direção / Dirección / Steering		
				1513 (L*LA*LAK*LB*LG*LK*LS) * 1514 (L*LK*LS) * 1516 (L*LA*LAK*LB*LG*LK*LS) * 1517 (L*LK) * 1518 (L*LK*LS) * 1519 (L*LAK*LB*LG*LK*LS) * 1520 (L*LK*LP*LPK*LPS*LS) * 1521 L * 1524 e 1525 (L*LK*LS)	Motor / Motor / Engine		
				1517 OF * 1518 OF * 1520 OF			
				1614 * 1615 (L*LK*LS) * 1615 * 1618 M * 1618 (L*LK*LS) * 1619 (L) 1618 OF	Direção / Dirección / Steering		
				1620(L*LK*LS) * 1620 6X2 51 (L) * 1621 (L*LK*LS) * 1622(L*LK*LS) * 1623 (L*LS) * 1625(L*LK*LS) * 1630 (L*LK*LS) * 1632 (L*LS) * 1633(L*LK*LS) * 1634 (L*LS) * 1635 L			
				1620 OF * 1621 OF			
				1924 (LS) * 1924 A (LS) * 1929 (L*LK*LS) * 1930 (LS) * 1932 (LS) * 1933 (LS) * 1934 (LS) * 1935 (L*LS) * 1938 * 1938 S * 1938 (L*LS) * 1941 (L*LS) * 1944 S * 1945 (L*LS)	Motor / Motor / Engine		
				2213 (L*LB*LK*LS) * 2213 6X6 (LA) * 2214 * 2215 (L*LB*LK*LS)* 2216 (L*LA*LAK*LB*LG*LK*LS) * 2217 (L*LB*LK*LS) * 2219 (L*LA*LAK*LB*LG*LK*LS) * 2220 * 2222 * 2225 (L*LB*LK*LS)			
				331 (L*LPK*LPS) 60...68			
				1113 OF * 1115 OF	Direção / Dirección / Steering		
				1313 OF * 1314 OF * 1315 OF * 1316 OF * 1317 OF * 1318 OF * 1319 OF * 1320 OF	Motor / Motor / Engine		
				1417 OF * 1419 OF * 1421 OF	Direção / Dirección / Steering		
				1421 OMC	Motor / Motor / Engine		
				1517 OF * 1518 OF * 1520 OF	Motor / Motor / Engine		
				1618 OF	Direção / Dirección / Steering		
		1620 OF * 1621 OF	Direção / Dirección / Steering				
			AGCO MAXION	Colhedeira Combinada Automotriz 1170DS * 1175DS * 1630 Arroeira * 3640 Arroeira * 5650 * MF 220A * 220CBD * 220STD * MF 310CBD * 310STD * 210 * 210S * 220 * 310	Plataforma Flexível / Plataforma Flexível / Flexivel Platform		
				AGRALE	Tratores 4100 * 4200 * 4300 * T145 * T146 * T415 * T420	Eixo Dianteiro / Eje Delantero / Front Axle	
				BALDAN	Semeadeira SD 5000 * Terraceador de Arrasto TACR	Roçadeira / Desbrozadora / Weed Eating	
				CBT	Tratores 1000 * 1000 (4x4) * 1020 * 1020 (4x4) * 1065 * 1065 (4x4) * 1090 * 1105	Plataforma Flexível / Plataforma Flexível / Flexivel Platform	
				FNH	Colhedeiras 4040 * 5030 * 5050 * 8040 * 8055 * TC55 * TC57 * CA1530	Câmbio / Caja de Cambios / Gearbox	
					Todos / Todos / All		
				JOHN DEERE	Tratores 4600 * 4610 * 4630 * 5600 * 5610 * 5630 * 6600 * 6610 * 6630 * 7610 * 7630 * 7810 * 7830 * 8030 * 8BR		
					Colhedeiras CA1165 * CA1175 * CA1185 * CA1450 * CA1550-02 * CA1550-03	Eixo Traseiro / Eje Trasero / Rear Axle	
				MARCHESAN	Arado de Aivecas Helicoidais AAH	Embreagem / Embrague / Clutch	
					Plantadeira Hidráulica Tatu PHT * PHT Suprema	Caixa de Redução / Caja de Reducción / Reduction Box	
					Semeadeira Direta Articulada SDA 3	Caixa de Distribuição / Caja de Distribución / Distribution Box	
					PONTIAC	Matiz	Eixo Traseiro / Eje Trasero / Rear Axle
		30206 F	TRB		MERCEDES BENZ	1113 (LPO*OH) * 1114 LPO * 1115 L (OH) * 1118 LPO	Direção / Dirección / Steering
						1313 OH * 1314 OH * 1315 OH * 1316 (OH*OHL) * 1316 G (OH*OHL) * 1317 OH * 1318 OH * 1319 OH * 1320 (OH*OHL)	Motor / Motor / Engine
						1418 OH * 1419 OH * 1420 (OH*OHL) * 1421 OHL	
						1621 L (OH) * 1623 LG (OH) * 1625 (OH) * 1625 L (OH) * 1628 L (OH) * 1630L (OH) * 1635 (OH) * 1636 L (OH)	
						321 H (O) * 321 HL (O) (58...71)	
326 O							
352 HL (O) (...74)							
355 O							
360 HL (O) (...74)	Direção / Dirección / Steering						









Fersa®			Brand / Marca / Marca	Model / Modelo / Modelo	Application / Aplicação / Aplicaciones			
30206 F	TRB		MERCEDES BENZ	362 O	Direção / Dirección / Steering			
				364 O				
				370 RS*RSD*RST* ST*U*UP (O) * 371 RS*RSD*RST* ST*U*UP (O)				
				400 (R * RS * RSD * RSL) (O)				
				O 371 R * O 371 RS * O 371 RSD				
				O 370 R * O 370 RS * O 370 RSD		Caixa de Mudanças / Caja de Cambios / Gearbox		
		VOLKSWAGEN	15 - 210	Direção / Dirección / Steering				
			4 - 140210					
			MERCEDES BENZ	1113 (L*LA*LAK*LAS*LK*LP*LS*LP) * 1114 * 1114 (L*LK*LP) * 1116 (L*LA*LAK*LAS*LB* LK*LS) * 1118 (L*LK*LP)	Motor / Motor / Engine			
				1113 OF * 1115 OF				
				1313 (L*LA*LAK*LB*LK*LS) * 1314 (L*LA*LAK*LB*LK*LS) * 1316 (L*LA*LAK*LAS*LB*LK*LS) * 1317 (L*LA*LAK*LK*LS)* 1319 (L)	Direção / Dirección / Steering			
				1313 OF * 1314 OF * 1315 OF * 1316 OF * 1317 OF * 1318 OF * 1319 OF * 1320 OF				
				1414 * 1414 (K*L*LA*LAK*LK) * 1418 * 1418 (E*K*R) * 1418 (L*LA*LAK*LK*R(LK)) * 1419 (L*LK*LS) * 1420 (L*LK*LS)	Direção / Dirección / Steering			
				1417 OF * 1419 OF * 1421 OF				
				1421 OMC	Motor / Motor / Engine			
				1614 * 1615 (L*LK*LS) * 1615 * 1618 M * 1618 (L*LK*LS) * 1619 (L)				
				1618 OF	Direção / Dirección / Steering			
				1620(L*LK*LS) * 1620 6X2 51 (L) * 1621 (L*LK*LS) * 1622(L*LK*LS) * 1623 (L*LS) * 1625(L*LK*LS) * 1630 (L*LK*LS) * 1632 (L*LS) * 1633(L*LK*LS) * 1634 (L*LS) * 1635 L				
				1620 OF * 1621 OF	Motor / Motor / Engine			
				1113 OF * 1115 OF				
			MERCEDES BENZ	1313 OF * 1314 OF * 1315 OF * 1316 OF * 1317 OF * 1318 OF * 1319 OF * 1320 OF	Direção / Dirección / Steering			
				1417 OF * 1419 OF * 1421 OF				
				1421 OMC	Motor / Motor / Engine			
				1618 OF				
1620 OF * 1621 OF	Direção / Dirección / Steering							
		BALDAN	Arado Fixo AF	Arado / Arado / Plow				
	Arado Fixo de AIVECAS AAFL * AAFT							
	Arado Reversível ARH							
	Grade Laranja GLCRL		Grade / Gradeador / Harrows					
	JOHN DEERE	Grade Niveladora NVAM * NIVAP * NVCR * SNVAM * SNVAP * SP	Nivelador / Nivelador / Leveler					
		Colheitadeiras CA1165 * CA1175 * CA1185 * CA1450 * CA1550-02 * CA1550-03	Carro de Transporte 22 / Carro de Transporte 22					
		Plantadeiras PL 9200 * PL 9209 * PL9211	Eixo Traseiro / Eje Trasero / Rear Axle					
			Unidade de Separação e Limpeza / Unidad de Separación y Limpeza / Separation and Cleaning Unit					
	TOYOTA	Bandeirante	Diferencial / Diferencial / Differential					
			BALDAN	Arado Fixo AF	Arado / Arado / Plow			
Arado Reversível ARH								
Arado Subsolador ASDACR * ASDADR * ASDAH								
Arado Subsolador ASTH								
Carpideira CED Tandem * Carpideira Fixa Leve								
Grade Aradora GRSG * GTCR * GCRTI * GR * GRI * GRPI * GSPA * GRP * CRI								
Grade Laranja GLCRL	Grade / Gradeador / Harrows							
	SCANIA			T 113 H (6X4) Paradiso		Eixo Traseiro / Eje Trasero / Rear Axle		
						FIAT	FNM 2000 * 2150	Eixo Dianteiro / Eje Delantero / Front Axle
								AGRALE
Arado Escarificador AETC * AETH								
Arado Fixo AF								
Arado Reversível ARH								
Arado Subsolador ASDACR * ASDADR * ASDAH								
Arado Subsolador ASTH								
Carpideira CED Tandem * Carpideira Fixa Leve								
Grade Aradora GRSG * GTCR * GCRTI * GR * GRI * GRPI * GSPA * GRP * CRI								
Grade Laranja GLCRL	Grade / Gradeador / Harrows							





Fersa®			Brand / Marca / Marca	Model / Modelo / Modelo	Application / Aplicação / Aplicaciones			
30207 F	TRB		BALDAN	Grade Niveladora NVAM * NIVAP * NVCR * SNVAM * SNVAP * SP	Nivelador / Nivelador / Leveler			
				Roçadeira CPL * RD1300 * RD1500 * RD1700 * RPU 1700 * RP1300 * RPP * RPD 3000 * RDU 1500 * RDU1700 * RP 1500 * RP 1700 * RPU 1300 * RPU 1500 * RPD 2700 * RPD 2250	Caixa de Distribuição / Caja de Distribución / Distribution Box			
				Semeadeira SD 5000 * Terraceador de Arrasto TACR	Roçadeira / Desbrozadora / Weed Eating			
			FNH	Tratores 4600 * 4610 * 4630 * 5600 * 5610 * 5630 * 6600 * 6610 * 6630 * 7610 * 7630 * 7810 * 7830 * 8030 * 8BR	Eixo Dianteiro / Eje Delantero / Front Axle			
			JOHN DEERE	Colheitadeiras CA1165 * CA1175 * CA1185 * CA1450 * CA1550-02 * CA1550-03	Eixo Traseiro / Eje Trasero / Rear Axle			
			MARCHESAN	Arado de Aivecas Reversível Pesado AARP				
				Arado Subsolador com Desarme Automático AST * MATIC E 500				
				Distribuidor de Calcário & Adubo DCA 2 2500 * DCA 2 5500 * DCA 2 7500 * DCA DC 5500 * DCA DC 7500 * DCA DC 2500				
				Distribuidor de Calcário * Composto Orgânico DCC0 10500 * DCC0 2500 * DCC0 5550 * DCC0 7500				
				Grade Aradora Intermediária Controle Remoto GAICR * GAICR 300				
				Grade Aradora Intermediária Controle Remoto GAICRL, GAIM				
				Grade Aradora Mecânica GAM * GATCR				
				Grade Niveladora Controle Remoto GNCR * GND * GNDH * GNLCR * Grade Niveladora Flutuante Mecânica GNFM * GNM				
				Guincho Agrícola Tatu Giratório GAT G * GATR				
				Plantadeira Direta de Cereais * Pastagem PDGP				
		Roçadeira RC 2 1300 * RC 2 1500 * RC 2 1700						
		Roçadeira RC 2 2600 CL * LSL * RC 2 3100						
		Roçadeira RC 2 4500 * Roçadeira de Arrasto RCA 3100 * RCA E 3400						
		VALTRA - VALMET	Tratores 685 * 685C (4x4) * 785 * 785C (4x4) * 880 Cafeeiro * 880 (4x4) * 885 * 980 (4x4) * 985 * 985F * 1180 * 1184	Caixa de Redução / Caja de Reducción / Reduction Box				
			ALFA ROMEO	Alfa 2300	Eixo Dianteiro / Eje Delantero / Front Axle			
			FORD	Belina * Belina II * Corcel * Corcel II	Câmbio / Caja de Cambios / Gearbox			
				Belina I (...78) * Corcel I (...78)	Diferencial / Diferencial / Differential			
				Belina II (79...) * Corcel II (79...)	Câmbio / Caja de Cambios / Gearbox			
			LADA	Samara	Diferencial / Diferencial / Differential			
			30208 F	TRB		AGCO MAXION	Colheitadeira Combinada Automotriz 1170DS * 1175DS * 1630 Arroeira * 3640 Arroeira * 5650 * MF 220A * 220CBD * 220STD * MF 310CBD * 310STD * 210 * 210S * 220 * 310	Eixo Traseiro / Eje Trasero / Rear Axle
						AGRALE	Tratores 4100 * 4200 * 4300 * T145 * T146 * T415 * T420	Câmbio / Caja de Cambios / Gearbox
		CBT				Tratores 1000 * 1000 (4x4) * 1020 * 1020 (4x4) * 1065 * 1065 (4x4) * 1090 * 1105	Tomada de Potência / Toma de Potencia / Power Take-off	
Tratores 8060 (4x2) * 8060 (4x4) * 8240 * 8240A * 8260 * 8440 * 8450	Câmbio / Caja de Cambios / Gearbox							
FNH	Colheitadeiras 4040 * 5030 * 5050 * 8040 * 8055 * TC55 * TC57 * CA1530	Tomada de Potência / Toma de Potencia / Power Take-off						
	Tratores 4600 * 4610 * 4630 * 5600 * 5610 * 5630 * 6600 * 6610 * 6630 * 7610 * 7630 * 7810 * 7830 * 8030 * 8BR	Câmbio / Caja de Cambios / Gearbox						
VALTRA - VALMET	Tratores 60 * 60 ID * 62 * 65 * 65 Cafeeiro * 68 * 68 Cafeeiro * 78 * 80 * M80 * 85 * 85ID * 86 * 86 ID * 88 * 88 ID	Câmbio / Caja de Cambios / Gearbox						
	Tratores 110 ID * 110ID II * 118 * 118 (4x4) * 128 * 128 (4x4)	Direção / Dirección / Steering						
	Tratores 685 * 685C (4x4) * 785 * 785C (4x4) * 880 Cafeeiro * 880 (4x4) * 885 * 980 (4x4) * 985 * 985F * 1180 * 1184	Eixo Traseiro / Eje Trasero / Rear Axle						
		Tomada de Potência / Toma de Potencia / Power Take-off						
		Tração Dianteira / Tracción Delantera / Front Traction						













Fersa®			Brand / Marca / Marca	Model / Modelo / Modelo	Application / Aplicação / Aplicaciones
30208 F	TRB		MITSUBISHI	L 200	Eixo Traseiro / Eje Trasero / Rear Axle
				L 300	
				Montero * Pajero	
			NISSAN	Frontier	
				Pathfinder	
				Pick Up 2200	
				Pick Up 2200 4 x 4	
				Pick Up 2500	
				Pick Up 2500 4 x 4	
				Pick Up 2700 4 x 4	
				Pick Up 2700 4 x 4	
Terrano					
X-Terra					
30209 F	TRB		BALDAN	Roçadeira RD 2250 * RD 2700 * RD3000 * RDD	Roçadeira / Desbrozadora / Weed Eating
			JOHN DEERE	Colheitadeiras CA1165 * CA1175 * CA1185 * CA1450 * CA1550-02 * CA1550-03	Carro de Transporte 22 / Carro de Transporte 22 Eixo Traseiro / Eje Trasero / Rear Axle
			VALTRA - VALMET	Tratores 110 ID * 110ID II * 118 * 118 (4x4) * 128 * 128 (4x4)	Tomada de Potência / Toma de Potencia / Power Take-off
30210 F	TRB		AGCO MAXION	Tratores MF 235 (4x4) Antigo * MF 235 Moderno* 250 * 265 * MF265 RD * 270 * 274 * 275 * 285 * 290 * MF 292 (4x4) * 295 * 296 * 299	Eixo Dianteiro / Eje Delantero / Front Axle
				Tratores MF (50X * 55X * 65R * 65X * 85 * 85X * 95 * 95X)	Tração Dianteira / Tracción Delantera / Front Traction
			BALDAN	Arado Escarificador AETC * AETH	Arado / Arado / Plow
				Arado Subsolador ASDACR * ASDADR * ASDAH	Nivelador / Nivelador / Leveler
			CBT	Grade Niveladora NVAM * NIVAP * NVCR * SNVAM * SNVAP * SP	
				Tratores 1000 * 1000 (4x4) * 1020 * 1020 (4x4) * 1065 * 1065 (4x4) * 1090 * 1105	Eixo Dianteiro / Eje Delantero / Front Axle
			JOHN DEERE	Tratores 8060 (4x2) * 8060 (4x4) * 8240 * 8240A * 8260 * 8440 * 8450	Eixo Traseiro / Eje Trasero / Rear Axle Redução / Reducción / Reduction Transmissão / Transmisión / Transmission
				Colheitadeiras CA1165 * CA1175 * CA1185 * CA1450 * CA1550-02 * CA1550-03	
				Plantadeiras PL 9200 * PL 9209 * PL9211	
			MARCHESAN	Tratores 5403 * 5600 Aeroportuário * 5605 * 5705 * 6605 * 7500 Aeroportuário * 7505	Eixo Dianteiro / Eje Delantero / Front Axle
				Arado Subsolador com Desarme Automático AST * MATIC E 500	Eixo Traseiro / Eje Trasero / Rear Axle
MARCHESAN	Grade Hidráulica * Grade Niveladora * Grade Niveladora Flutuante * GNL	Caixa de Redução / Caja de Reducción / Reduction Box			
	Grade Niveladora Controle Remoto GNCR * GND * GNDH * GNLGR * Grade Niveladora Flutuante Mecânica GNFM * GNM				
30211 F	TRB	References Fersa with Multiple Applications / Referências Fersa com Múltiplas Aplicações / Referencias Fersa con Multiples Aplicaciones			
30212 F	TRB		MARCHESAN	Grade Aradora GA	Caixa de Redução / Caja de Reducción / Reduction Box
				Grade Aradora Mecânica GAM * GATCR	
30213 F	TRB		FIAT	FNM V-15 (69...74)	Eixo Traseiro / Eje Trasero / Rear Axle
30214 F	TRB		MERCEDES BENZ	1313 OH * 1314 OH * 1315 OH * 1316 (OH*OHL) * 1316 G (OH*OHL) * 1317 OH * 1318 OH * 1319 OH * 1320 (OH*OHL)	Eixo Dianteiro / Eje Delantero / Front Axle
				MERCEDES BENZ	
		VOLVO	1313 OF * 1314 OF * 1315 OF * 1316 OF * 1317 OF * 1318 OF * 1319 OF * 1320 OF		
			MERCEDES BENZ	FH 12 * FH 16 * FH 16	
30216 F	TRB		MERCEDES BENZ	1313 OF * 1314 OF * 1315 OF * 1316 OF * 1317 OF * 1318 OF * 1319 OF * 1320 OF	Eixo Dianteiro / Eje Delantero / Front Axle
				331 (L*LPK*LPS) 60...68	Eixo Traseiro / Eje Trasero / Rear Axle













Fersa®			Brand / Marca / Marca	Model / Modelo / Modelo	Application / Aplicação / Aplicaciones						
30217 F	TRB		SCANIA	101 (L*LS) * 111 (B) * 111 Articulado (B)	Eixo Traseiro / Eje Trasero / Rear Axle						
				110 (B)							
				110 (L*LS)							
				111 (L*LS*LT)							
				115 * 116 BR							
				140 (LK*LKS)							
				K 113							
				K 94 IB (4X2)							
		VOLVO	P 93 * R 113 * R 143* T 113	Caixa de Mudanças / Caja de Cambios / Gearbox							
			7550	9700							
		30220 F	TRB		SCANIA	112 (F*K*S)	Eixo Traseiro / Eje Trasero / Rear Axle				
						75 * 76 B*L*LS					
						F 113 * L 113 * K 113					
						P 114 GA (4X2) * R 114 GA (4X2 * 6X4) * T 114 GA (4X2) * T 114 LA (6X2)					
P 94 CB (4x2 * 6x2 * 6X4)											
P 94 GA*GB (4X2)											
R 112 (81...)											
R 142 MA (4X2)(81...)											
T 142 E (6X4)											
VOLVO	FH 12 * FH 16 * FH 16					N * NL 10 BR * N * NL 12 BR * N 10BR Mark II * NL 10BR 6x2		NH 12 * FM 12			
	30222 F			TRB		FIAT	190 (77...)	Eixo Traseiro / Eje Trasero / Rear Axle			
							FNM 210 C * CM * LN (71...76)				
							30302 F	TRB		MERCEDES BENZ	1113 (LPO*OH) * 1114 LPO * 1115 L (OH) * 1118 LPO
321 H (O) * 321 HL (O) (58...71)											
326 O											
		MERCEDES BENZ	1018 MBO								
			1111 (L*LA*LAK* LAS*LK*LS)								
			1113 (L*LA*LAK*LAS*LK*LP*LS*LP) * 1114 * 1114 (L*LK*LP) * 1116 (L*LA*LAK*LAS*LB* LK*LS) * 1118 (L*LK*LP)								
			1113 OF * 1115 OF								
			312 (L*LK*LP) 51...58								
			321 (LAP*LAPK*LAPS*LP* LPK*LPS) 51...71								
			321 LAP * LAPK * LAPS * LP * LPK * LPS								
		MERCEDES BENZ	1018 MBO								
			1113 OF * 1115 OF								
	CBT	2070 * 2080 * 2100 * 2105 (4x2) * 2400 * 2400 (4x4) * 2500 * 2600									
		Tratores 1000 * 1000 (4x4) * 1020 * 1020 (4x4) * 1065 * 1065 (4x4) * 1090 * 1105									
		VALTRA - VALMET Tratores 110 ID * 110ID II * 118 * 118 (4x4) * 128 * 128 (4x4)									
30303 F	TRB	References Fersa with Multiple Applications / Referências Fersa com Múltiplas Aplicações / Referencias Fersa con Múltiples Aplicaciones									
30304 F	TRB		FORD	Belina * Belina II * Corcel * Corcel II	Eixo Traseiro / Eje Trasero / Rear Axle						
				Del Rey * Pampa							
			VOLKSWAGEN	Fusca	Eixo Dianteiro / Eje Delantero / Front Axle						
				Karmann Ghia							









Fersa®			Brand / Marca / Marca	Model / Modelo / Modelo	Application / Aplicação / Aplicaciones		
30305 F	TRB		AGRALE	Tratores 4100 * 4200 * 4300 * T145 * T146 * T415 * T420	Câmbio / Caja de Cambios / Gearbox		
			MASSEY FERGUSON	MF50X * MF55X * MF65R * MF65X * MF85 * MF85X * MF95 * MF95X	Tomada de Força / Toma de Fuerza / Power Take-off		
			VOLKSWAGEN	Fusca Karmann Ghia Kombi	Eixo Dianteiro / Eje Delantero / Front Axle		
30306 F	TRB		MERCEDES BENZ	608 D * E (L*LO) * 708 D * E (L*LO) * 709 L * 710 L * 712 L O 817	Caixa de Mudanças / Caja de Cambios / Gearbox		
			VOLVO	B 10M BR	Motor / Motor / Engine		
				B 10R * B 12B * B 12R * B 58 * B 58BR * B 7R * B9			
		B 58 B 58 BR (...Chassi 304120)					
			FIAT	70 (77...) * 80	Eixo Dianteiro / Eje Delantero / Front Axle		
			MERCEDES BENZ	608 (L*LO) * 708 (L*LO) * 809 (LO*OF) * 812 (LO*OF) * 814 LO * 817 O * 914 LO * 709 * 710 * 712 * 712 C * 811 * 911 L * 912 * 913 * 914 * 914 C * 917 312 (L*LK*LP) 51...58	Caixa de Mudanças / Caja de Cambios / Gearbox		
				L 1312			
				L 911 * L 912 * L 913 * L 914			
				LK 312			
				LO 709 * LO 710 * LO 712			
VOLVO	B 10R * B 12B * B 12R * B 58 * B 58BR * B 7R * B9						
	MERCEDES BENZ	LO 709 * LO 710 * LO 712					
	KIA	Besta (2.2 * 2.7 * GS)	Direção / Dirección / Steering				
	TOYOTA	Bandeirante	Diferencial / Diferencial / Differential				
	VOLKSWAGEN	Kombi	Eixo Dianteiro / Eje Delantero / Front Axle				
30307 F	TRB		KIA	Besta (2.2 * 2.7 * GS)	Direção / Dirección / Steering		
			TOYOTA	Bandeirante	Caixa de transferência / Caja de Transferencia / Transfer Case		
			FIAT	FNM D-9500 (50...57)	Direção / Dirección / Steering		
30308 F	TRB		MERCEDES BENZ	1113 (LPO*OH) * 1114 LPO * 1115 L (OH) * 1118 LPO 1313 OH * 1314 OH * 1315 OH * 1316 (OH*OHL) * 1316 G (OH*OHL) * 1317 OH * 1318 OH * 1319 OH * 1320 (OH*OHL) 1418 OH * 1419 OH * 1420 (OH*OHL) * 1421 OHL 1418 OH * 1419 OH * 1420 (OH*OHL) * 1421 OHL 1418 OH * 1419 OH * 1420 (OH*OHL) * 1421 OHL 1517 OH * 1518 OH * 1519 OH * 1520 OH * 1521 OH 1621 L (OH) * 1623 LG (OH) * 1625 (OH) * 1625 L (OH) * 1628 L (OH) * 1630L (OH) * 1635 (OH) * 1636 L (OH) 1721 L (OH) 1721 L (OH) 321 H (O) * 321 HL (O) (58...71) 326 O 352 HL (O) (...74) 355 O 362 O 364 O 370 RS*RSD*RST* ST*U*UP (O) * 371 RS*RSD*RST* ST*U*UP (O) 608 D * E (L*LO) * 708 D * E (L*LO) * 709 L * 710 L * 712 L 812 LO * 912 L	Caixa de Mudanças / Caja de Cambios / Gearbox		
						MERCEDES BENZ	608 (L*LO) * 708 (L*LO) * 809 (LO*OF) * 812 (LO*OF) * 814 LO * 817 O * 914 LO * 709 * 710 * 712 * 712 C * 811 * 911 L * 912 * 913 * 914 * 914 C * 917 1018 MBO 1111 (L*LA*LAK* LAS*LK*LS)

















Fersa®			Brand / Marca / Marca	Model / Modelo / Modelo	Application / Aplicação / Aplicaciones
30308 F	TRB		MERCEDES BENZ	1113 (L*LA*LAK*LAS*LK*LP*LS*LP) * 1114 * 1114 (L*LK*LP) * 1116 (L*LA*LAK*LAS*LB* LK*LS) * 1118 (L*LK*LP)	Caixa de Mudanças / Caja de Cambios / Gearbox
				1113 OF * 1115 OF	
				1313 (L*LA*LAK*LB*LK*LS) * 1314 (L*LA*LAK*LB*LK*LS) * 1316 (L*LA*LAK*LAS*LB*LK*LS) * 1317 (L*LA*LAK*LK*LS) * 1319 (L)	
				1313 OF * 1314 OF * 1315 OF * 1316 OF * 1317 OF * 1318 OF * 1319 OF * 1320 OF	
				1414 * 1414 (K*L*LA*LAK*LK) * 1418 * 1418 (E*K*R) * 1418 (L*LA*LAK*LK*R(LK)) * 1419 (L*LK*LS) * 1420 (L*LK*LS)	
				1417 OF * 1419 OF * 1421 OF	
				1421 OMC	
				1513 (L*LA*LAK*LB*LG*LK*LS) * 1514 (L*LK*LS) * 1516 (L*LA*LAK*LB*LG*LK*LS) * 1517 (L*LK) * 1518 (L*LK*LS) * 1519 (L*LAK*LB*LG*LK*LS) * 1520 (L*LK*LP*LPK*LPS*LS) * 1521 L * 1524 e 1525 (L*LK*LS)	
				1517 OF * 1518 OF * 1520 OF	
				1614 * 1615 (L*LK*LS) * 1615 * 1618 M * 1618 (L*LK*LS) * 1619 (L)	
				1618 OF	
				1620(L*LK*LS) * 1620 6X2 51 (L) * 1621 (L*LK*LS) * 1622(L*LK*LS) * 1623 (L*LS) * 1625(L*LK*LS) * 1630 (L*LK*LS) * 1632 (L*LS) * 1633(L*LK*LS) * 1634 (L*LS) * 1635 L	
				1620 OF * 1621 OF	
				1714 OF * 1721 OF * 1722 OF	
				1714 * 1714 (L*K*LK) * 1715 * 1718 * 1718 (A * AK) * K * 1720 L * 1721 * 1721 S * 1721 (L*LK) * 1722 S * 1723 * 1723 S * 1725 L	
				2013 (L*LA*LAK*LB*LG*LK*LS) * 2013 6X2 (L) * 2014 (L*LB*LK) * 2016 (LB*LK) * 2017 (L*LB*LK)	
				2213 (L*LB*LK*LS) * 2213 6X6 (LA) * 2214 * 2215 (L*LB*LK*LS) * 2216 (L*LA*LAK*LB*LG*LK*LS) * 2217 (L*LB*LK*LS) * 2219 (L*LA*LAK*LB*LG*LK*LS) * 2220 * 2222 * 2225 (L*LB*LK*LS)	
				2314 (L*LB*LK*LS) * 2318 (L*LB*LK*LS) * 2325 (L*LB*LK*LS)	
		2414 (6X4) * 2414 (L) * 2418 (L*LB*LK) * 2420 (L*LB*LK) * 2423 B 6X4 * 2423 K 6X4 * 2425 6X6 (LA) * 2425 (L*LB*LK) * 2428 6X4			
		321 (LAP*LAPK*LAPS*LP* LPK*LPS) 51...71			
		321 LAP * LAPK * LAPS * LP * LPK * LPS			
		LO 709 * LO 710 * LO 712			
			MERCEDES BENZ	1018 MBO	Caixa de Mudanças / Caja de Cambios / Gearbox
				1113 OF * 1115 OF	
				1313 OF * 1314 OF * 1315 OF * 1316 OF * 1317 OF * 1318 OF * 1319 OF * 1320 OF	
				1417 OF * 1419 OF * 1421 OF	
				1421 OMC	
				1517 OF * 1518 OF * 1520 OF	
				1618 OF	
				1620 OF * 1621 OF	
				1714 OF * 1721 OF * 1722 OF	
				LO 709 * LO 710 * LO 712	
			JOHN DEERE	Colheitadeiras CA1165 * CA1175 * CA1185 * CA1450 * CA1550-02 * CA1550-03	Transmissão / Transmisión / Transmission
	MERCEDES BENZ	1113 (LPO*OH) * 1114 LPO * 1115 L (OH) * 1118 LPO	Caixa de Mudanças / Caja de Cambios / Gearbox		
		1313 OH * 1314 OH * 1315 OH * 1316 (OH*OHL) * 1316 G (OH*OHL) * 1317 OH * 1318 OH * 1319 OH * 1320 (OH*OHL)			
		1418 OH * 1419 OH * 1420 (OH*OHL) * 1421 OHL			
		321 H (O) * 321 HL (O) (58...71)			
	FIAT	70 (77...) * 80	Eixo Dianteiro / Eje Delantero / Front Axle		
	MERCEDES BENZ	1018 MBO	Caixa de Mudanças / Caja de Cambios / Gearbox		
		1111 (L*LA*LAK* LAS*LK*LS)			
		1113 (L*LA*LAK*LAS*LK*LP*LS*LP) * 1114 * 1114 (L*LK*LP) * 1116 (L*LA*LAK*LAS*LB* LK*LS) * 1118 (L*LK*LP)			
		1113 OF * 1115 OF			
		1313 (L*LA*LAK*LB*LK*LS) * 1314 (L*LA*LAK*LB*LK*LS) * 1316 (L*LA*LAK*LAS*LB*LK*LS) * 1317 (L*LA*LAK*LK*LS) * 1319 (L)			
		1313 OF * 1314 OF * 1315 OF * 1316 OF * 1317 OF * 1318 OF * 1319 OF * 1320 OF			
		1414 * 1414 (K*L*LA*LAK*LK) * 1418 * 1418 (E*K*R) * 1418 (L*LA*LAK*LK*R(LK)) * 1419 (L*LK*LS) * 1420 (L*LK*LS)			
		1417 OF * 1419 OF * 1421 OF			







Fersa®			Brand / Marca / Marca	Model / Modelo / Modelo	Application / Aplicação / Aplicaciones	
30309 F	TRB		MERCEDES BENZ	1421 OMC 1614 * 1615 (L*LK*LS) * 1615 * 1618 M * 1618 (L*LK*LS) * 1619 (L) 1618 OF 2213 (L*LB*LK*LS) * 2213 6X6 (LA) * 2214 * 2215 (L*LB*LK*LS) * 2216 (L*LA*LAK*LB*LG*LK*LS) * 2217 (L*LB*LK*LS) * 2219 (L*LA*LAK*LB*LG*LK*LS) * 2220 * 2222 * 2225 (L*LB*LK*LS) 321 (LAP*LAPK*LAPS*LP* LPK*LPS) 51...71 321 LAP * LAPK * LAPS * LP * LPK * LPS	Caixa de Mudanças / Caja de Cambios / Gearbox	
			MERCEDES BENZ	1018 MBO 1113 OF * 1115 OF 1313 OF * 1314 OF * 1315 OF * 1316 OF * 1317 OF * 1318 OF * 1319 OF * 1320 OF 1417 OF * 1419 OF * 1421 OF 1421 OMC 1618 OF		
			MERCEDES BENZ	1113 (LPO*OH) * 1114 LPO * 1115 L (OH) * 1118 LPO 321 H (O) * 321 HL (O) (58...71) 326 O 352 HL (O) (...74) 355 O O 355		Eixo Dianteiro / Eje Delantero / Front Axle
			SCANIA	K 113 K 114 IB (4X2) Busscar K 114 IB (4X2) LB 340 Irizar K 114 IB 4X2 NB 340 K K 124 EB (4X2 * 6X2) * K 124 IB (4X2 * 6X2 * 8X2) K 94 IB (4X2)		Caixa de Mudanças / Caja de Cambios / Gearbox Eixo Traseiro / Eje Trasero / Rear Axle Caixa de Mudanças / Caja de Cambios / Gearbox
			MERCEDES BENZ	1018 MBO 1111 (L*LA*LAK* LAS*LK*LS) 1113 (L*LA*LAK*LAS*LK*LP*LS*LP) * 1114 * 1114 (L*LK*LP) * 1116 (L*LA*LAK*LAS*LB* LK*LS) * 1118 (L*LK*LP) 1113 OF * 1115 OF 2414 (6X4) * 2414 (L) * 2418 (L*LB*LK) * 2420 (L*LB*LK) * 2423 B 6X4 * 2423 K 6X4 * 2425 6X6 (LA) * 2425 (L*LB*LK) * 2428 6X4 312 (L*LK*LP) 51...58 321 (LAP*LAPK*LAPS*LP* LPK*LPS) 51...71 321 LAP * LAPK * LAPS * LP * LPK * LPS L 1312 LAK 1113 * LAK 1116 * LAK 1118 LAK 2213 * LAK 2214 * LAK 2215 * LAK 2216 * LAK 2217 * LAK 2219 * LAK 2220 * LAK 2222 * LAK 2225 LAS 1113 * LAS 1114 * LAS 1116 * LAS 1118 LB 1116 * LB 1117 * LB 1118 LK 1113 * LK 1114 * LK 1116 * LK 1117 * LK 1118 LK 312 LP 1114 * LPO 1114 * LS 1114 LP 1116 * LPO 1116 * LS 1116 LP 1117 * LPO 1117 * LS 1117 LP 1118 * LPO 1118 * LS 1118 LP 1312 LP 321 * LPK 321 OF 1111 * OF 1113 * OF 1114 * OF 1115 * OF 1116 * OF 1117 * OF 1118		Eixo Dianteiro / Eje Delantero / Front Axle Caixa de Mudanças / Caja de Cambios / Gearbox Eixo Dianteiro / Eje Delantero / Front Axle
			SCANIA	75 * 76 B*L*LS LA 94 UB 4X2 LB * LA 6X4 NA P 114 CB 6X4 NA 340 P 114 GA (4X2) * R 114 GA (4X2 * 6X4) * T 114 GA (4X2) * T 114 LA (6X2) P 124 CA (6X4) * P 124 GA*GB (4X2) * R 124 LA (4X2) * T 124 GA (4X2 * 6X4) * T 124 LA (4X2) P 94 CB (4x2 * 6x2 * 6X4)		Caixa de Mudanças / Caja de Cambios / Gearbox Eixo Traseiro / Eje Trasero / Rear Axle Caixa de Mudanças / Caja de Cambios / Gearbox Caixa de Mudanças / Caja de Cambios / Gearbox







Fersa*			Brand / Marca / Marca	Model / Modelo / Modelo	Application / Aplicação / Aplicaciones	
30312 F	TRB		SCANIA	P 94 DB 4X2 NA 220 * P 94 DB 6X2 NA260	Eixo Traseiro / Eje Trasero / Rear Axle	
				P 94 GA*GB (4X2)	Caixa de Mudanças / Caja de Cambios / Gearbox	
				R 114 LA 4X2 NA340	Eixo Traseiro / Eje Trasero / Rear Axle	
				R 124 GA 4X2 NA400	Eixo Traseiro / Eje Trasero / Rear Axle	
				Série 4 (4X2)	Caixa de Mudanças / Caja de Cambios / Gearbox	
				T 124 GA 6X4 * T 124 LA 6X4 NA400	Eixo Traseiro / Eje Trasero / Rear Axle	
	TRB		MERCEDES BENZ	1018 MBO	Eixo Dianteiro / Eje Delantero / Front Axle	
				1113 OF * 1115 OF OF 1111 * OF 1113 * OF 1114 * OF 1115 * OF 1116 * OF 1117 * OF 1118		
	TRB		CBT	2070 * 2080 * 2100 * 2105 (4x2) * 2400 * 2400 (4x4) * 2500 * 2600	Eixo Traseiro / Eje Trasero / Rear Axle	
				VALTRA - VALMET	Tratores 110 ID * 110ID II * 118 * 118 (4x4) * 128 * 128 (4x4)	Câmbio / Caja de Cambios / Gearbox
Tratores 870 CN * CK			Eixo Traseiro / Eje Trasero / Rear Axle			
30313 F	TRB		MERCEDES BENZ	1517 OH * 1518 OH * 1519 OH * 1520 OH * 1521 OH	Eixo Dianteiro / Eje Delantero / Front Axle	
				Multego IBC 1842 * IBC 2242 * OC 500	Eixo Traseiro / Eje Trasero / Rear Axle	
				O 371 R * O 371 RS * O 371 RSD		
				O 400 R * O 400 RS * O 400 RSD * O 400 RSE * O 400 RSL * MP 105 * MP 108 DD * MP120 * MP 180 DD		
	TRB		MERCEDES BENZ	1513 (L*LA*LAK*LB*LG*LK*LS) * 1514 (L*LK*LS) * 1516 (L*LA*LAK*LB*LG*LK*LS) * 1517 (L*LK) * 1518 (L*LK*LS) * 1519 (L*LAK*LB*LG*LK*LS) * 1520 (L*LK*LP*LPK*LPS*LS) * 1521 L * 1524 e 1525 (L*LK*LS)	Eixo Dianteiro / Eje Delantero / Front Axle	
				1517 OF * 1518 OF * 1520 OF		
				331 (L*LPK*LPS) 60...68		
	TRB		MERCEDES BENZ	1517 OF * 1518 OF * 1520 OF		
	30314 F	TRB		SCANIA	K 113	Caixa de Mudanças / Caja de Cambios / Gearbox
					K 114 IB (4X2) Busscar	Eixo Traseiro / Eje Trasero / Rear Axle
K 114 IB (4X2) LB 340 Irizar						
K 114 IB 4X2 NB 340 K						
K 124 EB (4X2 * 6X2) * K 124 IB (4X2 * 6X2 * 8X2)						
TRB			SCANIA	K 94 IB (4X2)	Caixa de Mudanças / Caja de Cambios / Gearbox	
				75 * 76 B*L*LS		
				LA 94 UB 4X2 LB * LA 6X4 NA		
				P 114 CB 6X4 NA 340		
				P 114 GA (4X2) * R 114 GA (4X2 * 6X4) * T 114 GA (4X2) * T 114 LA (6X2)		
				P 124 CA (6X4) * P 124 GA*GB (4X2) * R 124 LA (4X2) * T 124 GA (4X2 * 6X4) * T 124 LA (4X2)		
				P 94 CB (4x2 * 6x2 * 6X4)		
				P 94 DB (4X2) NA 220 * P 94 DB (6X2) NA260		
				P 94 GA*GB (4X2)		
R 114 LA 4X2 NA340						
Série 4 (4X2)						
T 124 GA 6X4 * T 124 LA 6X4 NA400						
31306 F	TRB		TOYOTA	Bandeirante	Diferencial / Diferencial / Differential	
31308 F	TRB		SCANIA	101 (L*LS) * 111 (B) * 111 Articulado (B)	Eixo Dianteiro / Eje Delantero / Front Axle	
				110 (B)		
				110 (L*LS)		
				115 * 116 BR		
	TRB		VOLVO	N * NL 10 BR * N * NL 12 BR * N 10BR Mark II * NL 10BR 6x2		
				VALTRA - VALMET	Tratores 60 * 60 ID * 62 * 65 * 65 Cafeeiro * 68 * 68 Cafeeiro * 78 * 80 * M80 * 85 * 85ID * 86 * 86 ID * 88 * 88 ID	Câmbio / Caja de Cambios / Gearbox
Tratores 110 ID * 110ID II * 118 * 118 (4x4) * 128 * 128 (4x4)	Eixo Traseiro / Eje Trasero / Rear Axle					
Tratores 685 * 685C (4x4) * 785 * 785C (4x4) * 880 Cafeeiro * 880 (4x4) * 885 * 980 (4x4) * 985 * 985F * 1180 * 1184	Câmbio / Caja de Cambios / Gearbox					
				Tracção Dianteira / Tracción Delantera / Front Traction		





Fersa®			Brand / Marca / Marca	Model / Modelo / Modelo	Application / Aplicação / Aplicaciones							
31308 F	TRB		TOYOTA	Bandeirante	Diferencial / Diferencial / Differential Tomada de Força / Toma de Fuerza / Power Take-off							
31309 F	TRB		SCANIA	101 (L*LS) * 111 (B) * 111 Articulado (B)	Eixo Dianteiro / Eje Delantero / Front Axle							
				110 (B)								
				110 (L*LS)								
				115 * 116 BR								
		K 94 IB (4X2)										
		75 * 76 B*L*LS										
			SCANIA	P 94 CB (4x2 * 6x2 * 6X4)								
				P 94 GA*GB (4X2)								
31311 F	TRB		MERCEDES BENZ	331 (L*LPK*LPS) 60...68	Eixo Traseiro / Eje Trasero / Rear Axle							
31312 F	TRB		SCANIA	101 (L*LS) * 111 (B) * 111 Articulado (B)	Eixo Traseiro / Eje Trasero / Rear Axle							
				110 (B)								
				110 (L*LS)								
				111 (L*LS*LT)								
				115 * 116 BR								
				140 (LK*LKS)								
				K 113 IB (4X2) Busscar								
				K 114 IB (4X2) Busscar								
				K 114 IB (4X2) LB 340 Irizar								
				K 114 IB 4X2 NB 340 K								
				K 124 CA 4x2 NB 340K								
				K 124 CA (6x4 * 6x2)								
				K 94 IB (4X2)								
				L 114 IB (4X2) LB 340 Urbanuss								
				L 94 VB (4X2) 220HP Urbanuss								
				P 93 * R 113 * R 143* T 113								
				T 113 H (6X4) Paradiso								
								FIAT	130 OD (78...)	Eixo / Eje / Axle		
		180 C * C3 * L* N * N3 (71...)										
		FNM 210 C * CM * LN (71...76)										
		MERCEDES BENZ	L1113 * L1114 * L1116 * L1117 * L1118									
		112 (F*K*S)										
		75 * 76 B*L*LS										
					SCANIA	F 113 * L 113 * K 113	Eixo Traseiro / Eje Trasero / Rear Axle					
						LA 94 UB 4X2 LB * LA 6X4 NA						
						P 114 * R 124 * T 114 CB 6x4 * 4x2 * T 124						
						P 114 CB 6X4 NA 340						
						P 94 CB (4x2 * 6x2 * 6X4)						
						94I * 94H * 94U * P94 CB (6x4*4x2) * 114L * P114 * T114 CB (6x4*4x2) * 124E * R124 * K124 CA (6x4*6x2) * T124 * P124 CA * CB (6x4*4x2) * 164 * P230 * P270 * P310 * P340 * P420 * R380 * R420 * R480						
						P 94 GA*GB (4X2)						
						R 112 (81...)						
						R 124 GA 4X2 NA400						
						R 142 MA (4X2)(81...)						
						Série 4 (4X2)						
						T 124 GA 6X4 * T 124 LA 6X4 NA400						
						T 142 E (6X4)						
										VOLVO	FH 12 * FH 16 * FH 16	
											N * NL 10 BR * N * NL 12 BR * N 10BR Mark II * NL 10BR 6x2	
											NH 12 * FM 12	
										CBT	Tratores 8060 (4x2) * 8060 (4x4) * 8240 * 8240A * 8260 * 8440 * 8450	Câmbio / Caja de Cambios / Gearbox
											VALTRA - VALMET	
					FIAT	Tratores 110 ID * 110ID II * 118 * 118 (4x4) * 128 * 128 (4x4)	Eixo Traseiro / Eje Trasero / Rear Axle					
Tratores 685 * 685C (4x4) * 785 * 785C (4x4) * 880 Cafeeiro * 880 (4x4) * 885 * 980 (4x4) * 985 * 985F * 1180 * 1184												
				FNM D-11000 (58...72)								







Fersa*			Brand / Marca / Marca	Model / Modelo / Modelo	Application / Aplicação / Aplicaciones	
31313 F	TRB		MERCEDES BENZ	1621 L (OH) * 1623 LG (OH) * 1625 (OH) * 1625 L (OH) * 1628 L (OH) * 1630L (OH) * 1635 (OH) * 1636 L (OH)	Eixo Traseiro / Eje Trasero / Rear Axle	
				1721 L (OH)		
				370 RS*RSD*RST* ST*U*UP (O) * 371 RS*RSD*RST* ST* U*UP (O)		
				O500M 1728 * O500R 1735		
				SCANIA		111 (L*LS*LT)
				FIAT		FNM V-15 (69...74)
			MERCEDES BENZ	1614 * 1615 (L*LK*LS) * 1615 * 1618 M * 1618 (L*LK*LS) * 1619 (L)		
				1618 OF		
				1620(L*LK*LS) * 1620 6X2 51 (L) * 1621 (L*LK*LS) * 1622(L* LK*LS) * 1623 (L*LS) * 1625(L*LK*LS) * 1630 (L*LK*LS) * 1632 (L*LS) * 1633(L*LK*LS) * 1634 (L*LS) * 1635 L		
				1620 OF * 1621 OF		
				1714 OF * 1721 OF * 1722 OF		
				1714 * 1714 (L*K*LK) * 1715 * 1718 * 1718 (A * AK) * K * 1720 L * 1721 * 1721 S * 1721 (L*LK) * 1722 S * 1723 * 1723 S * 1725 L		
				1924 (LS) * 1924 A (LS) * 1929 (L*LK*LS) * 1930 (LS) * 1932 (LS) * 1933 (LS) * 1934 (LS) * 1935 (L*LS) * 1938 * 1938 S * 1938 (L*LS) * 1941 (L*LS) * 1944 S * 1945 (L*LS)		
				Axor 2625 * 2628 * 2629 (LK*LS) * 2631 (B*K*L) * 2632 * 2635 (B*K*L) * 2635 (L*LK*LS) * 2635 * 2638 (L*LK*LS) * Axor 2640 * 2641 * 2643 * Axor 2644 * Actos 2646 * 2648 * 2650 * 2651 * 2653 * 2654 (L*LK*LS) * 2657 * 2658 * 2644 * Atego 2628 (B*K) * 2625 * Axor 2826 * Axor 2828 * Axor 2831		
31314 F	TRB		SCANIA	K 94 IB (4X2)	Eixo Traseiro / Eje Trasero / Rear Axle	
			FIAT	190 (77...) FNM 210 C * CM * LN (71...76)		
			SCANIA	75 * 76 B*L*LS	Eixo / Eje / Axle	
				P 94 CB (4x2 * 6x2 * 6X4)	Eixo Traseiro / Eje Trasero / Rear Axle	
				P 94 GA*GB (4X2)		
31315 F	TRB		VOLVO	FH 12 * FH 16 * FH 16	Eixo Traseiro / Eje Trasero / Rear Axle	
				N * NL 10 BR * N * NL 12 BR * N 10BR Mark II * NL 10BR 6x2		
				NH 12 * FM 12		
31594 / 31520	TRB		INTERNATIONAL	3000 RE	Caixa de Mudanças / Caja de Cambios / Gearbox	
			MERCEDES BENZ	O500M 1728 * O500R 1735		
				OMC 1628 58 Andare		
			VOLVO	C 11R * C 12R		
			DINA	D9 160 * D12 160 Cab Over		
			FORD	Cargo 1415 * 1416		
		Cargo 1422 * 1514 * 1517 * 1517E * 1615 * 1615T * 1617 * 1618 * 1618T * 1619 * 1621 * 1622 * 1717E * 1722 * 1722E * 2216 * 2217 * 2218 * 2218T * 2319 * 2322 * 2324 * 2422 * 2422E * 2425 * 2428E * 2630 * 3224 * 3530 * 4030				
		F-800				
		FREIGHTLINER	FL 80 * FL 80 QR 4X2			
			FS 65 MT45 * MT45A. M2 52K 6X2			
		GENERAL MOTORS	Kodiak			
		INTERNATIONAL	4200 VT 365 * 4300 DT 466 / 195 HP			
			4400-215HP 4X2 * 4400-250HP * 4400-285HP * 4400-300HP			
		KENWORTH	T300 4X2 * 6X4			
		MERCEDES BENZ	L1214 * L1215 * L1217 39 * L1217 52 * L1218 52			
			MBO 1018 44			
MBO 1019 44 Boxer						
MBO 1219 52 Boxer						
MBO 1418 60						
MBO 1419 60 Boxer						
OMC 1419 51						
OMC 1423 51 Torino						
OMC 1425 51 Allegro						





Fersa®			Brand / Marca / Marca	Model / Modelo / Modelo	Application / Aplicação / Aplicaciones	
31594 / 31520	TRB		MERCEDES BENZ	MBO 1018 44	Caixa de Mudanças / Caja de Cambios / Gearbox	
				MBO 1019 44 Boxer		
				MBO 1217		
				MBO 1219 52 Boxer		
				MBO 1418 60		
				MBO 1419 60 Boxer		
				OMC 1419 51		
				OMC 1421 51		
		OMC 1425 51 Allegro				
			FORD	F 1000 (79...)		Diferencial / Diferencial / Differential
				F 75		
				Jeep Willys (4X2 * 4X4) (60...83)		
			Rural (4X2 * 4X4)			
			GENERAL MOTORS	Blazer * Gran Blazer		
D 20 (Bonanza * Veraneio)						
Silverado						
31597 / 31520	TRB		DINA	761	Eixo Traseiro / Eje Trasero / Rear Axle	
3196 / 3120	TRB		DINA	531 K * 532 J	Eixo Dianteiro / Eje Delantero / Front Axle	
			DINA	500 * 501		
32006 XF	TRB	References Fersa with Multiple Applications / Referências Fersa com Múltiplas Aplicações / Referencias Fersa con Multiples Aplicaciones				
32007 XF	TRB		GENERAL MOTORS	Corsa (hatch * pick-up * sedan)	Diferencial / Diferencial / Differential	
				Tigra		
32008 XF	TRB		KIA	Sportage (2.0 * 2.2)	Diferencial / Diferencial / Differential	
			LADA	1600		
				Samara		
32009 XF	TRB		FIAT	Brava	Diferencial / Diferencial / Differential	
				Doblò		
				Marea * Marea Turbo * Marea Weekend		
				Tempra		
			MERCEDES BENZ	Câmbio / Caja de Cambios / Gearbox		
				Diferencial / Diferencial / Differential		
				Câmbio / Caja de Cambios / Gearbox		
32010 XF	TRB		FIAT	Ducato	Eixo / Eje / Shaft	
			MBB	180 D	Diferencial / Diferencial / Differential	
			MERCEDES BENZ	MB 180		
32011 XF	TRB		MERCEDES BENZ	2013 (L*LA*LAK*LB*LG*LK*LS) * 2013 6X2 (L) * 2014 (L*LB*LK) * 2016 (LB*LK) * 2017 (L*LB*LK)	Eixo Traseiro / Eje Trasero / Rear Axle	
			CBT	Tratores 1000 * 1000 (4x4) * 1020 * 1020 (4x4) * 1065 * 1065 (4x4) * 1090 * 1105		
			MERCEDES BENZ	Sprinter 415 Sprinter 416 Sprinter 515		Eixo Traseiro / Eje Trasero / Rear Axle
32012 XF	TRB		MERCEDES BENZ	2013 (L*LA*LAK*LB*LG*LK*LS) * 2013 6X2 (L) * 2014 (L*LB*LK) * 2016 (LB*LK) * 2017 (L*LB*LK)	Eixo Traseiro / Eje Trasero / Rear Axle	
			CBT	2070 * 2080 * 2100 * 2105 (4x2) * 2400 * 2400 (4x4) * 2500 * 2600 Tratores 1000 * 1000 (4x4) * 1020 * 1020 (4x4) * 1065 * 1065 (4x4) * 1090 * 1105	Câmbio / Caja de Cambios / Gearbox	
32014 XF	TRB		MERCEDES BENZ	1418 OH * 1419 OH * 1420 (OH*OHL) * 1421 OHL 915 (LO) * 915 C	Eixo Traseiro / Eje Trasero / Rear Axle	
			MERCEDES BENZ	1414 * 1414 (K*L*LA*LAK*LK) * 1418 * 1418 (E*K*R) * 1418 (L*LA*LAK*LK*R(LK)) * 1419 (L*LK*LS) * 1420 (L*LK*LS)		
				1417 OF * 1419 OF * 1421 OF		
				1421 OMC		





















Fersa®			Brand / Marca / Marca	Model / Modelo / Modelo	Application / Aplicação / Aplicaciones	
32014 XF	TRB		MERCEDES BENZ	2013 (L*LA*LAK*LB*LG*LK*LS) * 2013 6X2 (L) * 2014 (L*LB*LK) * 2016 (LB*LK) * 2017 (L*LB*LK) 615 (LO) * 715 C	Eixo Traseiro / Eje Trasero / Rear Axle	
32015 XF	TRB		FORD	Cargo 1113 * 1114 * 1116 * 1117	Eixo Traseiro / Eje Trasero / Rear Axle	
				Cargo 1215		
				Cargo 1313 * 1314 * 1317 * 1317E		
				Cargo 1415 * 1416		
32015 XF	TRB		MERCEDES BENZ	Cargo 1422 * 1514 * 1517 * 1517E * 1615 * 1615T * 1617 * 1618 * 1618T * 1619 * 1621 * 1622 * 1717E * 1722 * 1722E * 2216 * 2217 * 2218 * 2218T * 2319 * 2322 * 2324 * 2422 * 2422E * 2425 * 2428E * 2630 * 3224 * 3530 * 4030	Caixa de Mudanças / Caja de Cambios / Gearbox	
				2414 (6X4) * 2414 (L) * 2418 (L*LB*LK) * 2420 (L*LB*LK) * 2423 B 6X4 * 2423 K 6X4 * 2425 6X6 (LA) * 2425 (L*LB*LK) * 2428 6X4		
				VOLVO		FH 12 * FH 16 * FH 16
32016 XF	TRB		MERCEDES BENZ	608 (L*LO) * 708 (L*LO) * 809 (LO*OF) * 812 (LO*OF) * 814 LO * 817 O * 914 LO * 709 * 710 * 712 * 712 C * 811 * 911 L * 912 * 913 * 914 * 914 C * 917	Eixo Traseiro / Eje Trasero / Rear Axle	
			SCANIA	94I * 94H * 94U * P94 CB (6x4*4x2) * 114L * P114 * T114 CB (6x4*4x2) * 124E * R124 * K124 CA (6x4*6x2) * T124 * P124 CA * CB (6x4*4x2) * 164 * P230 * P270 * P310 * P340 * P420 * R380 * R420 * R480		
32017 XF	TRB		MERCEDES BENZ	1418 OH * 1419 OH * 1420 (OH*OHL) * 1421 OHL	Eixo Traseiro / Eje Trasero / Rear Axle	
				1721 L (OH)	Eixo Traseiro / Eje Trasero / Rear Axle	
				OH 1417 * OH 1418		
				O 1835		
				OH 1419 * OH 1420 * OH 1421		
				OH 1517 * OH 1518 * OH 1519 * OH 1520 * OH 1521		
		VOLVO	7550	Caixa de Mudanças / Caja de Cambios / Gearbox		
			9700			
			MERCEDES BENZ		1414 * 1414 (K*L*LA*LAK*LK) * 1418 * 1418 (E*K*R) * 1418 (L*LA*LAK*LK*R(LK)) * 1419 (L*LK*LS) * 1420 (L*LK*LS) 1417 OF * 1419 OF * 1421 OF	Eixo Traseiro / Eje Trasero / Rear Axle
					1421 OMC	Eixo Dianteiro / Eje Delantero / Front Axle
					1714 OF * 1721 OF * 1722 OF	
					1714 * 1714 (L*K*LK) * 1715 * 1718 * 1718 (A * AK) * K * 1720 L * 1721 * 1721 S * 1721 (L*LK) * 1722 S * 1723 S * 1725 L	
1819 (L*LAK*LB*LG*LK*LS) * 1820 LG						
2013 (L*LA*LAK*LB*LG*LK*LS) * 2013 6X2 (L) * 2014 (L*LB*LK) * 2016 (LB*LK) * 2017 (L*LB*LK)	Eixo Traseiro / Eje Trasero / Rear Axle					
L1414 * L1416						
L1418 39 * L1418 52 * L1418 60 * L1419 59 * L1420. L1422						
L1617 59						
L1618						
L1621 54 * L1621 59 * L1621 60 * L1621 70 * L1622 * L1623 * L1625						
L1630 * L1632 * L1633 * L1634						
LK1418 39 * LK1418 52						
LK1420 * LK1422						
L 1524 * L 1525						
L 1614 * L 1615						
L 1620						
L 1714 * L 1715 * L 1718 * L 1720 * L 1721 * L 1722 * L 1723 * L 1724 * L 1728						
L 1819 * L 1820 * L 1833						
LAK1524 * LAK1525						
LAK 1819 * LAK 1820 * LAK 1833						
LB 1524 * LB 1525						
LG 1524 * LG 1525						
LK 1414 * LK 1416						
LK 1524 * LK 1525						
LK 1614 * LK 1615 * LK 1617 * LK 1618 * LK 1620 * LK 1621 * LK 1622 * LK 1623 * LK 1625 * LK 1630 * LK 1633 * LK 1634						
LK 1714 * LK 1715 * LK 1718 * LK 1720 * LK 1721 * LK 1722 * LK 1723 * LK 1724 * LK 1728						
LO 709 * LO 710 * LO 712						









Fersa®			Brand / Marca / Marca	Model / Modelo / Modelo	Application / Aplicação / Aplicaciones			
32017 XF	TRB		MERCEDES BENZ	LP 1520 * LPK1520 * LPS1520	Eixo Traseiro / Eje Trasero / Rear Axle			
				LP 1525 * LPK1525 * LPS1525 * LS 1525				
				OF 1416 * OF 1417 * OF 1418 * OF 1419 * OF 1420 * OF 1421				
				OF 1517 * OF 1518 * OF 1519 * OF 1520 * OF 1521 * OF 1524 * OF 1525				
				OF 1618 * OF 1620 * OF 1621 * OF 1625 * OF 1628 * OF 1630 * OF 1635 * OF 1636				
				OF 1714 * OF 1718 * OF 1721 * OF 1725				
				FH 12 * FH 16 * FH 16				
		VOLVO	N * NL 10 BR * N * NL 12 BR * N 10BR Mark II * NL 10BR 6x2					
			NH 12 * FM 12					
			1714 OF * 1721 OF * 1722 OF	Eixo Dianteiro / Eje Delantero / Front Axle				
			MERCEDES BENZ	LO 709 * LO 710 * LO 712		Eixo Traseiro / Eje Trasero / Rear Axle		
				OF 1416 * OF 1417 * OF 1418 * OF 1419 * OF 1420 * OF 1421				
				OF 1517 * OF 1518 * OF 1519 * OF 1520 * OF 1521 * OF 1524 * OF 1525				
				OF 1618 * OF 1620 * OF 1621 * OF 1625 * OF 1628 * OF 1630 * OF 1635 * OF 1636				
OF 1714 * OF 1718 * OF 1721 * OF 1725								
32018 XF	TRB				MERCEDES BENZ		1313 OH * 1314 OH * 1315 OH * 1316 (OH*OHL) * 1316 G (OH*OHL) * 1317 OH * 1318 OH * 1319 OH * 1320 (OH*OHL)	Eixo Traseiro / Eje Trasero / Rear Axle
							1418 OH * 1419 OH * 1420 (OH*OHL) * 1421 OHL	
		1517 OH * 1518 OH * 1519 OH * 1520 OH * 1521 OH						
		1621 L (OH) * 1623 LG (OH) * 1625 (OH) * 1625 L (OH) * 1628 L (OH) * 1630L (OH) * 1635 (OH) * 1636 L (OH)						
		1721 L (OH)						
		370 RS*RSD*RST* ST*U*UP (O) * 371 RS*RSD*RST* ST* U*UP (O)						
		Multego IBC 1842 * IBC 2242 * OC 500						
		O 371 R * O 371 RS * O 371 RSD						
		O 400 R * O 400 RS * O 400 RSD * O 400 RSE * O 400 RSL * MP 105 * MP 108 DD * MP120 * MP 180 DD						
		O500M 1728 * O500R 1735						
		OH 1417 * OH 1418						
		O 370 U						
		O 371 U * O 371 UL * O 371 UP						
		OH 1113						
		OH 1419 * OH 1420 * OH 1421						
		OH 1517 * OH 1518 * OH 1519 * OH 1520 * OH 1521						
			MERCEDES BENZ			1214 C * 1214 K * 1214 (L*LK*LS) * 1215 * 1215 C * 1215 (L*LA*LK) * 1218 * 1218 R (L)		
				1215 OF * 1217 OF				
				1313 (L*LA*LAK*LB*LK*LS) * 1314 (L*LA*LAK*LB*LK*LS) * 1316 (L*LA*LAK*LAS*LB*LK*LS) * 1317 (L*LA*LAK*LK*LS) * 1319 (L)				
				1313 OF * 1314 OF * 1315 OF * 1316 OF * 1317 OF * 1318 OF * 1319 OF * 1320 OF				
				1414 * 1414 (K*L*LA*LAK*LK) * 1418 * 1418 (E*K*R) * 1418 (L*LA*LAK*LK*R(LK)) * 1419 (L*LK*LS) * 1420 (L*LK*LS)				
				1417 OF * 1419 OF * 1421 OF				
				1421 OMC				
				1513 (L*LA*LAK*LB*LG*LK*LS) * 1514 (L*LK*LS) * 1516 (L*LA*LAK*LB*LG*LK*LS) * 1517 (L*LK) * 1518 (L*LK*LS) * 1519 (L*LAK*LB*LG*LK*LS) * 1520 (L*LK*LP*LPK*LPS*LS) * 1521 L * 1524 e 1525 (L*LK*LS)				
				1517 OF * 1518 OF * 1520 OF				
				1614 * 1615 (L*LK*LS) * 1615 * 1618 M * 1618 (L*LK*LS) * 1619 (L)				
				1618 OF				
		1620(L*LK*LS) * 1620 6X2 51 (L) * 1621 (L*LK*LS) * 1622(L*LK*LS) * 1623 (L*LS) * 1625(L*LK*LS) * 1630 (L*LK*LS) * 1632 (L*LS) * 1633(L*LK*LS) * 1634 (L*LS) * 1635 L						
1620 OF * 1621 OF								
1714 OF * 1721 OF * 1722 OF								
1714 * 1714 (L*K*LK) * 1715 * 1718 * 1718 (A * AK) * K * 1720 L * 1721 * 1721 S * 1721 (L*LK) * 1722 S * 1723 * 1723 S * 1725 L								
2013 (L*LA*LAK*LB*LG*LK*LS) * 2013 6X2 (L) * 2014 (L*LB*LK) * 2016 (LB*LK) * 2017 (L*LB*LK)								











Fersa*			Brand / Marca / Marca	Model / Modelo / Modelo	Application / Aplicação / Aplicaciones
32018 XF	TRB		MERCEDES BENZ	2213 (L*LB*LK*LS) * 2213 6X6 (LA) * 2214 * 2215 (L*LB*LK*LS)* 2216 (L*LA*LAK*LB*LG*LK*LS) * 2217 (L*LB*LK*LS) * 2219 (L*LA*LAK*LB*LG*LK*LS) * 2220 * 2222 * 2225 (L*LB*LK*LS)	Eixo Traseiro / Eje Trasero / Rear Axle
				2314 (L*LB*LK*LS) * 2318 (L*LB*LK*LS) * 2325 (L*LB*LK*LS)	
				2414 (6X4) * 2414 (L) * 2418 (L*LB*LK) * 2420 (L*LB*LK) * 2423 B 6X4 * 2423 K 6X4 * 2425 6X6 (LA) * 2425 (L*LB*LK) * 2428 6X4	
				Axor 2625 * 2628 * 2629 (LK*LS) * 2631 (B*K*L) * 2632 * 2635 (B*K*L) * 2635 (L*LK*LS) * 2635 * 2638 (L*LK*LS) * Axor 2640 * 2641 * 2643 * Axor 2644 * Actos 2646 * 2648 * 2650 * 2651 * 2653 * 2654 (L*LK*LS) * 2657 * 2658 * 2644 * Atego 2628 (B*K) * 2625 * Axor 2826 * Axor 2828 * Axor 2831 2629 LS	
				2635 (L*LK*LS)	
				L1214 * L1215 * L1217 39 * L1217 52 * L1218 52	
				L1414 * L1416	
				L1418 39 * L1418 52 * L1418 60 * L1419 59 * L1420. L1422	
				L1617 59	
				L1618	
				L1621 54 * L1621 59 * L1621 60 * L1621 70 * L1622 * L1623 * L1625	
				L1630 * L1632 * L1633 * L1634	
				L2013 * L2014 * L2016 * L2017 * L2024 * L2036 * L2042	
				LK1418 39 * LK1418 52	
				LK1420 * LK1422	
				OF 1313 * OF 1314 * OF 1315 * OF 1316 * OF 1317 * OF 1318 51	
				L 1524 * L 1525	
				L 1614 * L 1615	
				L 1620	
				L 1714 * L 1715 * L 1718 * L 1720 * L 1721 * L 1722 * L 1723 * L 1724 * L 1728	
				L 2213 * L 2214 * L 2215 * L 2216 * L 2217 * L 2219 * L 2220	
				L 2222 * L 2225 * L 2314 * L 2318 * L 2325	
				L 2414 * L 2418 * L 2420 * L 2423 * L 2424 * L 2428	
				LAK1524 * LAK1525	
				LB 1524 * LB 1525	
				LG 1524 * LG 1525	
				LK 1414 * LK 1416	
				LK 1524 * LK 1525	
				LK 1614 * LK 1615 * LK 1617 * LK 1618 * LK 1620 * LK 1621 * LK 1622 * LK 1623 * LK 1625 * LK 1630 * LK 1633 * LK 1634	
				LK 1714 * LK 1715 * LK 1718 * LK 1720 * LK 1721 * LK 1722 * LK 1723 * LK 1724 * LK 1728	
				LK 2013 6X2 * LK 2014 * LK 2016 * LK 2017 * LK 2024 * LK 2036 * LK 2042	
				LK 2213 * LK 2214 * LK 2215 * LK 2216 * LK 2217 * LK 2219 * LK 2220 * LK 2222 * LK 2225	
				LK 2629 * LK 2635 * LK 2638 * LK 2654	
	LP 1524 * LPK1524 * LPS1524 * LS 1524				
	LP 1525 * LPK1525 * LPS1525 * LS 1525				
	LS 2629 * LS 2635 * LS 2638 * LS 2654				
	OF 1215 * OF 1217				
	OF 1320				
	OF 1416 * OF 1417 * OF 1418 * OF 1419 * OF 1420 * OF 1421				
	OF 1517 * OF 1518 * OF 1519 * OF 1520 * OF 1521 * OF 1524 * OF 1525				
	OF 1618 * OF 1620 * OF 1621 * OF 1625 * OF 1628 * OF 1630 * OF 1635 * OF 1636				
	OF 1714 * OF 1718 * OF 1721 * OF 1725				
	OF 1313 * OF 1314 * OF 1315 * OF 1316 * OF 1317 * OF 1318 51				
	OF 1215 * OF 1217				
	OF 1320				
	OF 1416 * OF 1417 * OF 1418 * OF 1419 * OF 1420 * OF 1421				
	OF 1517 * OF 1518 * OF 1519 * OF 1520 * OF 1521 * OF 1524 * OF 1525				
OF 1618 * OF 1620 * OF 1621 * OF 1625 * OF 1628 * OF 1630 * OF 1635 * OF 1636					
OF 1714 * OF 1718 * OF 1721 * OF 1725					
OF 1714 * OF 1718 * OF 1721 * OF 1725					
			MERCEDES BENZ	OF 1313 * OF 1314 * OF 1315 * OF 1316 * OF 1317 * OF 1318 51 OF 1215 * OF 1217 OF 1320 OF 1416 * OF 1417 * OF 1418 * OF 1419 * OF 1420 * OF 1421 OF 1517 * OF 1518 * OF 1519 * OF 1520 * OF 1521 * OF 1524 * OF 1525 OF 1618 * OF 1620 * OF 1621 * OF 1625 * OF 1628 * OF 1630 * OF 1635 * OF 1636 OF 1714 * OF 1718 * OF 1721 * OF 1725	









Fersa®			Brand / Marca / Marca	Model / Modelo / Modelo	Application / Aplicação / Aplicaciones	
32019 XF	TRB		MERCEDES BENZ	370 * 371 (RS * RSD * RST * ST * U * UP) (O)	Eixo Traseiro / Eje Trasero / Rear Axle	
			MERCEDES BENZ	400 (R * RS * RSD * RSL) (O)		
			MERCEDES BENZ	500 (O * M * R)		
			MERCEDES BENZ	1614 * 1615 (L * LK * LS) * 1615 * 1618 M * 1618 (L * LK * LS) * 1619 (L)	Caixa de Mudanças / Caja de Cambios / Gearbox	
			MERCEDES BENZ	1618 OF		
			MERCEDES BENZ	2414 (6X4) * 2414 (L) * 2418 (L * LB * LK) * 2420 (L * LB * LK) * 2423 B 6X4 * 2423 K 6X4 * 2425 6X6 (LA) * 2425 (L * LB * LK) * 2428 6X4		
			MERCEDES BENZ	1618 OF	Eixo Traseiro / Eje Trasero / Rear Axle	
			CBT	Tratores 8060 (4x2) * 8060 (4x4) * 8240 * 8240A * 8260 * 8440 * 8450	Câmbio / Caja de Cambios / Gearbox	
			VALTRA - VALMET	Tratores 60 * 60 ID * 62 * 65 * 65 Cafeeiro * 68 * 68 Cafeeiro * 78 * 80 * M80 * 85 * 85ID * 86 * 86 ID * 88 * 88 ID	Câmbio / Caja de Cambios / Gearbox	
			VALTRA - VALMET	Tratores 110 ID * 110ID II * 118 * 118 (4x4) * 128 * 128 (4x4)	Eixo Traseiro / Eje Trasero / Rear Axle	
VALTRA - VALMET	Tratores 685 * 685C (4x4) * 785 * 785C (4x4) * 880 Cafeeiro * 880 (4x4) * 885 * 980 (4x4) * 985 * 985F * 1180 * 1184		Eixo Traseiro / Eje Trasero / Rear Axle			
32020 XF	TRB		MERCEDES BENZ	1313 OH * 1314 OH * 1315 OH * 1316 (OH * OHL) *	Eixo Traseiro / Eje Trasero / Rear Axle	
			MERCEDES BENZ	1316 G (OH * OHL) * 1317 OH * 1318 OH * 1319 OH * 1320 (OH * OHL)		
			MERCEDES BENZ	1418 OH * 1419 OH * 1420 (OH * OHL) * 1421 OHL		
			MERCEDES BENZ	1517 OH * 1518 OH * 1519 OH * 1520 OH * 1521 OH		
			MERCEDES BENZ	1621 L (OH) * 1623 LG (OH) * 1625 (OH) * 1625 L (OH) * 1628 L (OH) * 1630L (OH) * 1635 (OH) * 1636 L (OH)		
			MERCEDES BENZ	1721 L (OH)		
			MERCEDES BENZ	915 (LO) * 915 C		
			MERCEDES BENZ	Multeigo IBC 1842 * IBC 2242 * OC 500		
			MERCEDES BENZ	O 371 R * O 371 RS * O 371 RSD		
			MERCEDES BENZ	OH 1417 * OH 1418		
			MERCEDES BENZ	O 1835		
			MERCEDES BENZ	OH 1113		
			MERCEDES BENZ	OH 1419 * OH 1420 * OH 1421		
			MERCEDES BENZ	OH 1517 * OH 1518 * OH 1519 * OH 1520 * OH 1521		
			MERCEDES BENZ	140 (LK * LKS)		
			MERCEDES BENZ	K 113 IB (4X2) Busscar		
			MERCEDES BENZ	K 124 CA (6x4 * 6x2)		
			MERCEDES BENZ	P 93 * R 113 * R 143 * T 113		
			MERCEDES BENZ	T 113 H (6X4) Paradiso		
				FREIGHTLINER		FC 80
			FREIGHTLINER	1214 C * 1214 K * 1214 (L * LK * LS) * 1215 * 1215 C * 1215 (L * LA * LK) * 1218 * 1218 R (L)		Eixo Traseiro / Eje Trasero / Rear Axle
			FREIGHTLINER	1215 OF * 1217 OF		Eixo Traseiro / Eje Trasero / Rear Axle
			FREIGHTLINER	1313 (L * LA * LAK * LB * LK * LS) * 1314 (L * LA * LAK * LB * LK * LS) * 1316 (L * LA * LAK * LAS * LB * LK * LS) * 1317 (L * LA * LAK * LK * LS) * 1319 (L)		Eixo Traseiro / Eje Trasero / Rear Axle
			FREIGHTLINER	1313 OF * 1314 OF * 1315 OF * 1316 OF * 1317 OF * 1318 OF * 1319 OF * 1320 OF		Eixo Traseiro / Eje Trasero / Rear Axle
			FREIGHTLINER	1414 * 1414 (K * L * LA * LAK * LK) * 1418 * 1418 (E * K * R) * 1418 (L * LA * LAK * LK * R (LK)) * 1419 (L * LK * LS) * 1420 (L * LK * LS)		Eixo Traseiro / Eje Trasero / Rear Axle
			FREIGHTLINER	1417 OF * 1419 OF * 1421 OF		Eixo Traseiro / Eje Trasero / Rear Axle
			FREIGHTLINER	1421 OMC		Eixo Traseiro / Eje Trasero / Rear Axle
			FREIGHTLINER	1513 (L * LA * LAK * LB * LG * LK * LS) * 1514 (L * LK * LS) * 1516 (L * LA * LAK * LB * LG * LK * LS) * 1517 (L * LK) * 1518 (L * LK * LS) * 1519 (L * LAK * LB * LG * LK * LS) * 1520 (L * LK * LP * LK * LPS * LS) * 1521 L * 1524 e 1525 (L * LK * LS)		Eixo Traseiro / Eje Trasero / Rear Axle
			FREIGHTLINER	1517 OF * 1518 OF * 1520 OF		Eixo Traseiro / Eje Trasero / Rear Axle
			FREIGHTLINER	1614 * 1615 (L * LK * LS) * 1615 * 1618 M * 1618 (L * LK * LS) * 1619 (L)		Eixo Traseiro / Eje Trasero / Rear Axle
			FREIGHTLINER	1618 OF		Eixo Traseiro / Eje Trasero / Rear Axle
			FREIGHTLINER	1620 (L * LK * LS) * 1620 6X2 51 (L) * 1621 (L * LK * LS) * 1622 (L * LK * LS) * 1623 (L * LS) * 1625 (L * LK * LS) * 1630 (L * LK * LS) * 1632 (L * LS) * 1633 (L * LK * LS) * 1634 (L * LS) * 1635 L		Eixo Traseiro / Eje Trasero / Rear Axle
			FREIGHTLINER	1620 OF * 1621 OF		Eixo Traseiro / Eje Trasero / Rear Axle
			FREIGHTLINER	1714 OF * 1721 OF * 1722 OF		Eixo Traseiro / Eje Trasero / Rear Axle
			FREIGHTLINER	1714 * 1714 (L * K * LK) * 1715 * 1718 * 1718 (A * AK) * K * 1720 L * 1721 * 1721 S * 1721 (L * LK) * 1722 S * 1723 * 1723 S * 1725 L		Eixo Traseiro / Eje Trasero / Rear Axle
			FREIGHTLINER	1924 (LS) * 1924 A (LS) * 1929 (L * LK * LS) * 1930 (LS) * 1932 (LS) * 1933 (LS) * 1934 (LS) * 1935 (L * LS) * 1938 * 1938 S * 1938 (L * LS) * 1941 (L * LS) * 1944 S * 1945 (L * LS)		Eixo Traseiro / Eje Trasero / Rear Axle
			FREIGHTLINER	2414 (6X4) * 2414 (L) * 2418 (L * LB * LK) * 2420 (L * LB * LK) * 2423 B 6X4 * 2423 K 6X4 * 2425 6X6 (LA) * 2425 (L * LB * LK) * 2428 6X4		Eixo Traseiro / Eje Trasero / Rear Axle











Fersa®			Brand / Marca / Marca	Model / Modelo / Modelo	Application / Aplicação / Aplicaciones
32020 XF	TRB		MERCEDES BENZ	L1113 * L1114 * L1116 * L1117 * L1118	Eixo Traseiro / Eje Trasero / Rear Axle
				L1214 * L1215 * L1217 39 * L1217 52 * L1218 52	
				L1414 * L1416	
				L1418 39 * L1418 52 * L1418 60 * L1419 59 * L1420. L1422	
				L1617 59	
				L1618	
				L1621 54 * L1621 59 * L1621 60 * L1621 70 * L1622 * L1623 * L1625	
				L1630 * L1632 * L1633 * L1634	
				L1924 * L1929 * L1930 * L1932 * L1933 * L1934 * L1935 * L1937 * L1938 * L1939 * L1941 * L1942 * L1944 * L1945 * L1951	
				LK1418 39 * LK1418 52	
				LK1420 * LK1422	
				OF 1313 * OF 1314 * OF 1315 * OF 1316 * OF 1317 * OF 1318 51	
				L 1524 * L 1525	
				L 1614 * L 1615	
				L 1620	
				L 1714 * L 1715 * L 1718 * L 1720 * L 1721 * L 1722 * L 1723 * L 1724 * L 1728	
				L 1819 * L 1820 * L 1833	
				LAK1524 * LAK1525	
				LAK 1819 * LAK 1820 * LAK 1833	
				LB 1524 * LB 1525	
				LG 1524 * LG 1525	
				LK 1414 * LK 1416	
				LK 1524 * LK 1525	
				LK 1614 * LK 1615 * LK 1617 * LK 1618 * LK 1620 * LK 1621 * LK 1622 * LK 1623 * LK 1625 * LK 1630 * LK 1633 * LK 1634	
				LK 1714 * LK 1715 * LK 1718 * LK 1720 * LK 1721 * LK 1722 * LK 1723 * LK 1724 * LK 1728	
				LP 1525 * LPK1525 * LPS1525 * LS 1525	
				LS 1524 * LP1524 * LPK1524 * LPS1524	
				LS 1929 * LS 1930 * LS 1932 * LS 1933 * LS 1934 * LS 1935 * LS 1937 * LS 1938 * LS 1939 * LS 1941 * LS 1942 * LS 1944 * LS 1945 * LS 1951	
				OF 1215 * OF 1217	
				OF 1320	
				OF 1416 * OF 1417 * OF 1418 * OF 1419 * OF 1420 * OF 1421	
				OF 1517 * OF 1518 * OF 1519 * OF 1520 * OF 1521 * OF 1524 * OF 1525	
				OF 1618 * OF 1620 * OF 1621 * OF 1625 * OF 1628 * OF 1630 * OF 1635 * OF 1636	
				OF 1714 * OF 1718 * OF 1721 * OF 1725	
		112 (F*K*S)			
		F 113 * L 113 * K 113			
		P 114 * R 124 * T 114 CB 6x4 * 4x2 * T 124			
		P 94 CB (4x2 * 6x2 * 6X4)			
		94I * 94H * 94U * P94 CB (6x4*4x2) * 114L * P114 * T114 CB (6x4*4x2) * 124E * R124 * K124 CA (6x4*6x2) * T124 * P124 CA * CB (6x4*4x2) * 164 * P230 * P270 * P310 * P340 * P420 * R380 * R420 * R480			
		R 112 (81...)			
		R 142 MA (4X2)(81...)			
		T 142 E (6X4)			
		OF 1313 * OF 1314 * OF 1315 * OF 1316 * OF 1317 * OF 1318 51			
		OF 1215 * OF 1217			
		OF 1320			
		OF 1416 * OF 1417 * OF 1418 * OF 1419 * OF 1420 * OF 1421			
		OF 1517 * OF 1518 * OF 1519 * OF 1520 * OF 1521 * OF 1524 * OF 1525			
OF 1618 * OF 1620 * OF 1621 * OF 1625 * OF 1628 * OF 1630 * OF 1635 * OF 1636					
OF 1714 * OF 1718 * OF 1721 * OF 1725					
	MERCEDES BENZ	OF 1313 * OF 1314 * OF 1315 * OF 1316 * OF 1317 * OF 1318 51			
		OF 1215 * OF 1217			
		OF 1320			
		OF 1416 * OF 1417 * OF 1418 * OF 1419 * OF 1420 * OF 1421			
		OF 1517 * OF 1518 * OF 1519 * OF 1520 * OF 1521 * OF 1524 * OF 1525			
		OF 1618 * OF 1620 * OF 1621 * OF 1625 * OF 1628 * OF 1630 * OF 1635 * OF 1636			
		OF 1714 * OF 1718 * OF 1721 * OF 1725			
	FNH	Colheitadeiras 4040 * 5030 * 5050 * 8040 * 8055 * TC55 * TC57 * CA1530	Eixo Dianteiro / Eje Delantero / Front Axle		









Fersa®			Brand / Marca / Marca	Model / Modelo / Modelo	Application / Aplicação / Aplicaciones
32021 XF	TRB		DINA	434 17570 Shuttle Bus	Eixo Traseiro / Eje Trasero / Rear Axle
			MASA	Ursus	
			MOTOR COACH	F12	
				P14	
			VOLVO	U 12 * U 18 Articulado	
			DINA	776	
			FORD	LT-800	
SCANIA	941 * 94H * 94U * P94 CB (6x4*4x2) * 114L * P114 * T114 CB (6x4*4x2) * 124E * R124 * K124 CA (6x4*6x2) * T124 * P124 CA * CB (6x4*4x2) * 164 * P230 * P270 * P310 * P340 * P420 * R380 * R420 * R480				
32022 XF	TRB		MERCEDES BENZ	1418 OH * 1419 OH * 1420 (OH*OHL) * 1421 OHL	Eixo Traseiro / Eje Trasero / Rear Axle
			SCANIA	111 (L*LS*LT)	
			MERCEDES BENZ	1414 * 1414 (K*L*LA*LAK*LK) * 1418 * 1418 (E*K*R) * 1418 (L*LA*LAK*LK*R(LK)) * 1419 (L*LK*LS) * 1420 (L*LK*LS)	
				1417 OF * 1419 OF * 1421 OF	
				1421 OMC	
				2013 (L*LA*LAK*LB*LG*LK*LS) * 2013 6X2 (L) * 2014 (L*LB*LK) * 2016 (LB*LK) * 2017 (L*LB*LK)	
		SCANIA	2635 (L*LK*LS)		
			112 (F*K*S)		
			R 112 (81...)		
			R 142 MA (4X2)(81...)		
32024 XF	TRB		MERCEDES BENZ	1924 (LS) * 1924 A (LS) * 1929 (L*LK*LS) * 1930 (LS) * 1932 (LS) * 1933 (LS) * 1934 (LS) * 1935 (L*LS) * 1938 * 1938 S * 1938 (L*LS) * 1941 (L*LS) * 1944 S * 1945 (L*LS)	Eixo Traseiro / Eje Trasero / Rear Axle
3206 B	BB2R		VOLVO	N * NL 10 BR * N * NL 12 BR * N 10BR Mark II * NL 10BR 6x2	Motor / Motor / Engine
3207 B 2RS / C3	BB2R		VOLVO	B 10M BR	Motor / Motor / Engine
				B 10R * B 12B * B 12R * B 58 * B 58BR * B 7R * B9	
			VOLVO	B 58 B 58 BR (...Chassi 304120) N * NL 10 BR * N * NL 12 BR * N 10BR Mark II * NL 10BR 6x2	
32205 BF	TRB		MERCEDES BENZ	1517 OH * 1518 OH * 1519 OH * 1520 OH * 1521 OH	Motor / Motor / Engine
				1513 (L*LA*LAK*LB*LG*LK*LS) * 1514 (L*LK*LS) * 1516 (L*LA*LAK*LB*LG*LK*LS) * 1517 (L*LK) * 1518 (L*LK*LS) * 1519 (L*LAK*LB*LG*LK*LS) * 1520 (L*LK*LP*LPK*LPS*LS) * 1521 L * 1524 e 1525 (L*LK*LS)	
			MERCEDES BENZ	1517 OF * 1518 OF * 1520 OF	
				2213 (L*LB*LK*LS) * 2213 6X6 (LA) * 2214 * 2215 (L*LB*LK*LS) * 2216 (L*LA*LAK*LB*LG*LK*LS) * 2217 (L*LB*LK*LS) * 2219 (L*LA*LAK*LB*LG*LK*LS) * 2220 * 2222 * 2225 (L*LB*LK*LS)	
	MERCEDES BENZ	1517 OF * 1518 OF * 1520 OF			
32205 F	TRB		MERCEDES BENZ	1517 OH * 1518 OH * 1519 OH * 1520 OH * 1521 OH	Motor / Motor / Engine
				370 RS*RSD*RST* ST*U*UP (O) * 371 RS*RSD*RST* ST*U*UP (O)	
			MERCEDES BENZ	1513 (L*LA*LAK*LB*LG*LK*LS) * 1514 (L*LK*LS) * 1516 (L*LA*LAK*LB*LG*LK*LS) * 1517 (L*LK) * 1518 (L*LK*LS) * 1519 (L*LAK*LB*LG*LK*LS) * 1520 (L*LK*LP*LPK*LPS*LS) * 1521 L * 1524 e 1525 (L*LK*LS)	
				1517 OF * 1518 OF * 1520 OF	
				Axor 2625 * 2628 * 2629 (LK*LS) * 2631 (B*K*L) * 2632 * 2635 (B*K*L) * 2635 (L*LK*LS) * 2635 * 2638 (L*LK*LS) * Axor 2640 * 2641 * 2643 * Axor 2644 * Actos 2646 * 2648 * 2650 * 2651 * 2653 * 2654 (L*LK*LS) * 2657 * 2658 * 2644 * Atego 2628 (B*K) * 2625 * Axor 2826 * Axor 2828 * Axor 2831	
				2629 LS 2635 (L*LK*LS)	
	MERCEDES BENZ	1517 OF * 1518 OF * 1520 OF			
32206 F	TRB		BALDAN	Arado Fixo AF	Arado / Arado / Plow
				Arado Reversível ARH	
				Carpideira CED Tandem * Carpideira Fixa Leve	
			JOHN DEERE	Plantadeiras PL 9200 * PL 9209 * PL9211	Transmissão / Transmisión / Transmission
				KIA	Sportage (2.0 * 2.2)
	MERCEDES BENZ	MB 180	Eixo Traseiro / Eje Trasero / Rear Axle		
	FIAT	FNM V-15 (69...74)	Direção / Dirección / Steering		









Fersa®			Brand / Marca / Marca	Model / Modelo / Modelo	Application / Aplicação / Aplicaciones	
32207 F	TRB		SCANIA	110 (L*LS)	Eixo Traseiro / Eje Trasero / Rear Axle	
				111 (L*LS*LT)		
				140 (LK*LKS)		
				K 124 CA (6x4 * 6x2)		
			SCANIA	P 114 * R 124 * T 114 CB 6x4 * 4x2 * T 124		
				P 94 CB (4x2 * 6x2 * 6X4)		
				94I * 94H * 94U * P94 CB (6x4*4x2) * 114L * P114 * T114 CB (6x4*4x2) * 124E * R124 * K124 CA (6x4*6x2) * T124 * P124 CA * CB (6x4*4x2) * 164 * P230 * P270 * P310 * P340 * P420 * R380 * R420 * R480		
			BALDAN	Arado Fixo AF		Arado / Arado / Plow
				Arado Fixo de AIVECAS AAFL * AAFT		
	KIA	Sportage (2.0 * 2.2)	Diferencial / Diferencial / Differential			
32208 F	TRB		MERCEDES BENZ	1418 OH * 1419 OH * 1420 (OH*OHL) * 1421 OHL	Caixa de Mudanças / Caja de Cambios / Gearbox	
				OH 1417 * OH 1418		
				O 817		
				OH 1419 * OH 1420 * OH 1421		
			SCANIA	101 (L*LS) * 111 (B) * 111 Articulado (B)		Tomada de Força / Toma de Fuerza / Power Take-off
				110 (B)		
				110 (L*LS)		
				111 (L*LS*LT)		
				115 * 116 BR		
				140 (LK*LKS)		
		P 93 * R 113 * R 143* T 113				
		MERCEDES BENZ	608 (L*LO) * 708 (L*LO) * 809 (LO*OF) * 812 (LO*OF) * 814 LO * 817 O * 914 LO * 709 * 710 * 712 * 712 C * 811 * 911 L * 912 * 913 * 914 * 914 C * 917	Caixa de Mudanças / Caja de Cambios / Gearbox		
			1214 C * 1214 K * 1214 (L*LK*LS) * 1215 * 1215 C * 1215 (L*LA*LK) * 1218 * 1218 R (L)			
			1215 OF * 1217 OF			
			1414 * 1414 (K*L*LA*LAK*LK) * 1418 * 1418 (E*K*R) * 1418 (L*LA*LAK*LK*R(LK)) * 1419 (L*LK*LS) * 1420 (L*LK*LS)			
			1417 OF * 1419 OF * 1421 OF			
			1421 OMC			
			L1214 * L1215 * L1217 39 * L1217 52 * L1218 52			
			L1414 * L1416			
			L1418 39 * L1418 52 * L1418 60 * L1419 59 * L1420. L1422			
			LK1418 39 * LK1418 52			
			LK1420 * LK1422			
			L 608 * L 708 * L 709 * L 710 * L 712 * L 714 * L 715 * L 718			
			L809 * L812 * L814 * L817			
			L 911 * L 912 * L 913 * L 914			
			LK 1414 * LK 1416			
			LO 608 * LO 708			
			LO 709 * LO 710 * LO 712			
			OF 1215 * OF 1217			
			OF 1416 * OF 1417 * OF 1418 * OF 1419 * OF 1420 * OF 1421			
			SCANIA		112 (F*K*S)	Tomada de Força / Toma de Fuerza / Power Take-off
		F 113 * L 113 * K 113				
		R 112 (81...)				
		R 142 MA (4X2)(81...)				
		R 142 MA (4X2)(81...)				
		T 142 E (6X4)				
			MERCEDES BENZ	1215 OF * 1217 OF	Caixa de Mudanças / Caja de Cambios / Gearbox	
				1417 OF * 1419 OF * 1421 OF		
				1421 OMC		
				LO 709 * LO 710 * LO 712		
	CBT	Tratores 8060 (4x2) * 8060 (4x4) * 8240 * 8240A * 8260 * 8440 * 8450	Eixo Dianteiro / Eje Delantero / Front Axle			
		VALTRA - VALMET		Tratores 110 ID * 110ID II * 118 * 118 (4x4) * 128 * 128 (4x4)		







Fersa®			Brand / Marca / Marca	Model / Modelo / Modelo	Application / Aplicação / Aplicaciones	
32208 F	TRB		VALTRA - VALMET	Tratores 110 ID * 110ID II * 118 * 118 (4x4) * 128 * 128 (4x4)	Tomada de Potência / Toma de Potencia / Power Take-off	
				Tratores 685 * 685C (4x4) * 785 * 785C (4x4) * 880 Cafeeiro * 880 (4x4) * 885 * 980 (4x4) * 985 * 985F * 1180 * 1184		Tração Dianteira / Tracción Delantera / Front Traction
32210 F	TRB		MERCEDES BENZ	1418 OH * 1419 OH * 1420 (OH*OHL) * 1421 OHL 608 D * E (L*LO) * 708 D * E (L*LO) * 709 L * 710 L * 712 L O 817	Caixa de Mudanças / Caja de Cambios / Gearbox	
			MERCEDES BENZ	608 (L*LO) * 708 (L*LO) * 809 (LO*OF) * 812 (LO*OF) * 814 LO * 817 O * 914 LO * 709 * 710 * 712 * 712 C * 811 * 911 L * 912 * 913 * 914 * 914 C * 917 1214 C * 1214 K * 1214 (L*LK*LS) * 1215 * 1215 C * 1215 (L*LA*LK) * 1218 * 1218 R (L) 1215 OF * 1217 OF 1414 * 1414 (K*L*LA*LAK*LK) * 1418 * 1418 (E*K*R) * 1418 (L*LA*LAK*LK*R(LK)) * 1419 (L*LK*LS) * 1420 (L*LK*LS) 1417 OF * 1419 OF * 1421 OF 1421 OMC L1214 * L1215 * L1217 39 * L1217 52 * L1218 52 L 608 * L 708 * L 709 * L 710 * L 712 * L 714 * L 715 * L 718 L 911 * L 912 * L 913 * L 914 LO 709 * LO 710 * LO 712 OF 1215 * OF 1217 OF 1714 * OF 1718 * OF 1721 * OF 1725		
			MERCEDES BENZ	1215 OF * 1217 OF 1417 OF * 1419 OF * 1421 OF 1421 OMC LO 709 * LO 710 * LO 712 OF 1215 * OF 1217 OF 1714 * OF 1718 * OF 1721 * OF 1725		
			AGCO MAXION	Colheteira Combinada Automotriz 1170DS * 1175DS * 1630 Arrozadeira * 3640 Arrozadeira * 5650 * MF 220A * 220CBD * 220STD * MF 310CBD * 310STD * 210 * 210S * 220 * 310		Eixo Traseiro / Eje Trasero / Rear Axle
			BALDAN	Arado Escarificador AETC * AETH Arado Fixo AF Arado Subsolador ASDACR * ASDADR * ASDAH Carpideira CED Tandem * Carpideira Fixa Leve Grade Aradora GRSG * GTCR * GCRTI * GR * GRI * GRPI * GSPA * GRP * CRI Roçadeira CPL * RD1300 * RD1500 * RD1700 * RPU 1700 * RP1300 * RPP * RPD 3000 * RDU 1500 * RDU1700 * RP 1500 * RP 1700 * RPU 1300 * RPU 1500 * RPD 2700 * RPD 2250 Roçadeira RD 2250 * RD 2700 * RD3000 * RDD		Arado / Arado / Plow
			CBT	2070 * 2080 * 2100 * 2105 (4x2) * 2400 * 2400 (4x4) * 2500 * 2600 Tratores 1000 * 1000 (4x4) * 1020 * 1020 (4x4) * 1065 * 1065 (4x4) * 1090 * 1105 Tratores 8060 (4x2) * 8060 (4x4) * 8240 * 8240A * 8260 * 8440 * 8450		Caixa de Distribuição / Caja de Distribución / Distribution Box Roçadeira / Desbrozadora / Weed Eating Câmbio / Caja de Cambios / Gearbox Eixo Dianteiro / Eje Delantero / Front Axle
			JOHN DEERE	Tratores 5403 * 5600 Aeroportuário * 5605 * 5705 * 6605 * 7500 Aeroportuário * 7505 Tratores 5403 * 5600 Aeroportuário * 5605 * 5705 * 6605 * 7500 Aeroportuário * 7505		Plataforma Flexível / Plataforma Flexível / Flexível Platform Tomada de Potência / Toma de Potencia / Power Take-off Câmbio / Caja de Cambios / Gearbox Tomada de Potência / Toma de Potencia / Power Take-off
			MARCHESAN	Arado de Aivecas Reversível Pesado AARP Arado Fixo AF * Arado Fixo Canavieiro AFC * Arado Fixo Leve AFL Arado Reversível AR * Arado Reversível com Pistão de Reversão ARPR Arado Subsolador com Desarme Automático AST * MATIC E 500 Distribuidor de Calcário & Adubo DCA 2 2500 * DCA 2 5500 * DCA 2 7500 * DCA DC 5500 * DCA DC 7500 * DCA DC 2500		Eixo Traseiro / Eje Trasero / Rear Axle







Fersa®			Brand / Marca / Marca	Model / Modelo / Modelo	Application / Aplicação / Aplicaciones	
32210 F	TRB		MARCHESAN	Distribuidor de Calcário * Composto Orgânico DCC0 10500 * DCC0 2500 * DCC0 5550 * DCC0 7500	Caixa de Redução / Caja de Reducción / Reduction Box	
				Grade Aradora Intermediária Controle Remoto GAICR * GAICR 300		
				Grade Aradora Intermediária Controle Remoto GAICRL, GAIM		
				Grade Aradora Mecânica GAM * GATCR		
				Grade Aradora Pesada Controle Remoto GAPCR * GAPM		
				Grade Aradora Super Pesada Controle Remoto GASPCR * GAPM		
				Grade Niveladora Controle Remoto GNCR * GND * GNDH * GNLCR * Grade Niveladora Flutuante Mecânica GNFM * GNM		
				Guincho Agrícola Tatu Giratório GAT G * GATR		
				Perfurador de Solo PS		
				Roçadeira RC 2 1300 * RC 2 1500 * RC 2 1700		
				Roçadeira RC 2 2600 CL * LSL * RC 2 3100		
				Roçadeira RC 2 4500 * Roçadeira de Arrasto RCA 3100 * RCA E 3400		
		VALTRA - VALMET	Tratores 60 * 60 ID * 62 * 65 * 65 Cafeeiro * 68 * 68 Cafeeiro * 78 * 80 * M80 * 85 * 85ID * 86 * 86 ID * 88 * 88 ID	Eixo Dianteiro / Eje Delantero / Front Axle		
			Tratores 110 ID * 110ID II * 118 * 118 (4x4) * 128 * 128 (4x4)	Tração Dianteira / Tracción Delantera / Front Traction		
			Tratores 1280 * 1284 * 1580 * 1780 * 1780 (4x4) * 1380 * 1680 * 1880 * 118 * 128 * 138 * 148 * 148 (4x4)	Tração Dianteira / Tracción Delantera / Front Traction		
			Tratores 360 D * 600 D * 621 ID	Eixo Dianteiro / Eje Delantero / Front Axle		
			Tratores 685 * 685C (4x4) * 785 * 785C (4x4) * 880 Cafeeiro * 880 (4x4) * 885 * 980 (4x4) * 985 * 985F * 1180 * 1184	Tração Dianteira / Tracción Delantera / Front Traction		
			Tratores 870 CN * CK	Eixo Traseiro / Eje Trasero / Rear Axle		
	MERCEDES BENZ	Sprinter 415	Eixo Traseiro / Eje Trasero / Rear Axle			
		Sprinter 416				
		Sprinter 515				
32211 F	TRB		MERCEDES BENZ	812 LO * 912 L	Caixa de Mudanças / Caja de Cambios / Gearbox	
32212 F	TRB		MERCEDES BENZ	321 H (O) * 321 HL (O) (58...71)	Eixo Traseiro / Eje Trasero / Rear Axle	
				326 O		
				O 355		
			VOLVO	7550		Caixa de Mudanças / Caja de Cambios / Gearbox
				9700		Eixo Traseiro / Eje Trasero / Rear Axle
						Caixa de Mudanças / Caja de Cambios / Gearbox
			MERCEDES BENZ	321 (LAP*LAPK*LAPS*LP* LPK*LPS) 51...71	Eixo Traseiro / Eje Trasero / Rear Axle	
				321 LAP * LAPK * LAPS * LP * LPK * LPS		
				L 1312		
				LAK 2213 * LAK 2214 * LAK 2215 * LAK 2216 * LAK 2217 * LAK 2219 * LAK 2220 * LAK 2222 * LAK 2225		
				LK 312		
				LP 1312		
LP 321 * LPK 321						
	BALDAN	Arado Fixo AF	Arado / Arado / Plow			
		Arado Reversível ARH				
		Grade Aradora GRSG * GTCR * GCRTI * GR * GRI * GRPI * GSPA * GRP * CRI				
		Arado Fixo AF * Arado Fixo Canavieiro AFC * Arado Fixo Leve AFL				
	MARCHESAN	Arado Reversível AR *	Eixo Traseiro / Eje Trasero / Rear Axle			
		Arado Reversível com Pistão de Reversão ARPR				
		Grade Aradora Controle Remoto Offset				
		Grade Aradora Intermediária Controle Remoto GAICR * GAICR 300				
		Grade Aradora Intermediária Controle Remoto GAICRL, GAIM				
		Grade Aradora Intermediária GAI				
Grade Aradora Pesada Controle Remoto GAPCR * GAPM	Caixa de Redução / Caja de Reducción / Reduction Box					
Grade Aradora Super Pesada Controle Remoto GASPCR * GAPM						





Fersa®			Brand / Marca / Marca	Model / Modelo / Modelo	Application / Aplicação / Aplicaciones			
32213 F	TRB		VOLVO	B 10M BR	Motor / Motor / Engine			
				B 10R * B 12B * B 12R * B 58 * B 58BR * B 7R * B9				
				B 58				
			FIAT	B 58 BR (...Chassi 304120)	Cardan / Cardan / Cardan			
				180 C * C3 * L * N * N3 (71...)				
				190 (77...)				
VOLVO	VOLVO	FNM 210 C * CM * LN (71...76)	Eixo Traseiro / Eje Trasero / Rear Axle					
		FNM V-15 (69...74)						
		B 10R * B 12B * B 12R * B 58 * B 58BR * B 7R * B9						
32214 F	TRB		MERCEDES BENZ	321 H (O) * 321 HL (O) (58...71)	Eixo Traseiro / Eje Trasero / Rear Axle			
				326 O				
				O 355				
			MERCEDES BENZ	FIAT		FNM V-15 (69...74)		
				MERCEDES BENZ		1214 C * 1214 K * 1214 (L*LK*LS) * 1215 * 1215 C * 1215 (L*LA*LK) * 1218 * 1218 R (L)		
						1215 OF * 1217 OF		
						312 (L*LK*LP) 51...58		
		MERCEDES BENZ	MERCEDES BENZ	L 1312		Eixo Traseiro / Eje Trasero / Rear Axle		
				LK 312				
				LP 1312				
	MERCEDES BENZ	MERCEDES BENZ	1215 OF * 1217 OF	Eixo Traseiro / Eje Trasero / Rear Axle				
			352 HL (O) (...74)					
32216 F	TRB		MERCEDES BENZ	1113 (LPO*OH) * 1114 LPO * 1115 L (OH) * 1118 LPO	Eixo Traseiro / Eje Trasero / Rear Axle			
				1418 OH * 1419 OH * 1420 (OH*OHL) * 1421 OHL				
				1517 OH * 1518 OH * 1519 OH * 1520 OH * 1521 OH				
				321 H (O) * 321 HL (O) (58...71)				
				326 O				
				352 HL (O) (...74)				
				355 O				
						MERCEDES BENZ	1018 MBO	Eixo Traseiro / Eje Trasero / Rear Axle
							1111 (L*LA*LAK* LAS*LK*LS)	
							1113 (L*LA*LAK*LAS*LK*LP*LS*LP) * 1114 * 1114 (L*LK*LP) * 1116 (L*LA*LAK*LAS*LB* LK*LS) * 1118 (L*LK*LP)	
							1113 OF * 1115 OF	
							1214 C * 1214 K * 1214 (L*LK*LS) * 1215 * 1215 C * 1215 (L*LA*LK) * 1218 * 1218 R (L)	
		1215 OF * 1217 OF						
		1414 * 1414 (K*L*LA*LAK*LK) * 1418 * 1418 (E*K*R) * 1418 (L*LA*LAK*LK*R(LK)) * 1419 (L*LK*LS) * 1420 (L*LK*LS)						
		1417 OF * 1419 OF * 1421 OF						
		1421 OMC						
		1513 (L*LA*LAK*LB*LG*LK*LS) * 1514 (L*LK*LS) * 1516 (L*LA*LAK*LB*LG*LK*LS) * 1517 (L*LK) * 1518 (L*LK*LS) * 1519 (L*LAK*LB*LG*LK*LS) * 1520 (L*LK*LP*LPK*LPS*LS) * 1521 L * 1524 e 1525 (L*LK*LS)						
		1517 OF * 1518 OF * 1520 OF						
		321 (LAP*LAPK*LAPS*LP* LPK*LPS) 51...71						
		321 LAP * LAPK * LAPS * LP * LPK * LPS						
		331 (L*LPK*LPS) 60...68						
		LAS 1111						
			MERCEDES BENZ	MERCEDES BENZ		1018 MBO	Eixo Traseiro / Eje Trasero / Rear Axle	
						1113 OF * 1115 OF		
						1215 OF * 1217 OF		
						1417 OF * 1419 OF * 1421 OF		
						1421 OMC		
		1517 OF * 1518 OF * 1520 OF						
			RANDON	RANDON		RK 425 B	Arado / Arado / Plow	
						BALDAN		Grade Aradora GRSG * GTCR * GCRTI * GR * GRI * GRPI * GSPA * GRP * CRI





Fersa®			Brand / Marca / Marca	Model / Modelo / Modelo	Application / Aplicação / Aplicaciones	
32216 F	TRB		MARCHESAN	Grade Aradora Pesada com Pneus GAPCW	Caixa de Redução / Caja de Reducción / Reduction Box	
				Grade Aradora Pesada Controle Remoto GAPCR * GAPM		
				Grade Aradora Pesada GAP * GAPC		
32218 F	TRB		MERCEDES BENZ	1517 OH * 1518 OH * 1519 OH * 1520 OH * 1521 OH	Eixo Traseiro / Eje Trasero / Rear Axle	
				OH 1517 * OH 1518 * OH 1519 * OH 1520 * OH 1521		
				101 (L*LS) * 111 (B) * 111 Articulado (B)		
			SCANIA	110 (B)		
				110 (L*LS)		
				115 * 116 BR		
				140 (LK*LKS)		
				P 93 * R 113 * R 143* T 113		
				17-210		
		VOLKSWAGEN	23-250			
			1513 (L*LA*LAK*LB*LG*LK*LS) * 1514 (L*LK*LS) * 1516 (L*LA*LAK*LB*LG*LK*LS) * 1517 (L*LK) * 1518 (L*LK*LS) * 1519 (L*LAK*LB*LG*LK*LS) * 1520 (L*LK*LP*LPK*LPS*LS) * 1521 L * 1524 e 1525 (L*LK*LS)			
		TRB		MERCEDES BENZ		1517 OF * 1518 OF * 1520 OF
						331 (L*LPK*LPS) 60...68
						L 1524 * L 1525
						L 331
						LAK1524 * LAK1525
						LB 1524 * LB 1525
						LG 1524 * LG 1525
	LK 1524 * LK 1525					
	LP 1525 * LPK1525 * LPS1525 * LS 1525					
	LPK 331 * LP S331					
	LS 1524 * LP1524 * LPK1524 * LPS1524					
	OF 1517 * OF 1518 * OF 1519 * OF 1520 * OF 1521 * OF 1524 * OF 1525					
	MERCEDES BENZ			OF 1618 * OF 1620 * OF 1621 * OF 1625 * OF 1628 * OF 1630 * OF 1635 * OF 1636		
				SCANIA		112 (F*K*S)
						75 * 76 B*L*LS
	F 113 * L 113 * K 113					
	R 112 (81...)					
	R 142 MA (4X2)(81...)					
	T 142 E (6X4)					
	VOLVO	VM 17 * VM 23 * VM 210				
		MERCEDES BENZ	1517 OF * 1518 OF * 1520 OF			
			OF 1517 * OF 1518 * OF 1519 * OF 1520 * OF 1521 * OF 1524 * OF 1525			
			OF 1618 * OF 1620 * OF 1621 * OF 1625 * OF 1628 * OF 1630 * OF 1635 * OF 1636			
	RANDON	RK 425 B				
		BALDAN	Grade Aradora GRSG * GTCR * GCRTI * GR * GRI * GRPI * GSPA * GRP * CRI	Arado / Arado / Plow		
MARCHESAN		Grade Aradora Super Pesada com Pneus GASPCW Grade Aradora Super Pesada Controle Remoto GASPCR * GAPM	Caixa de Redução / Caja de Reducción / Reduction Box			
32219 F	TRB		SCANIA	140 (LK*LKS)	Eixo Traseiro / Eje Trasero / Rear Axle	
			VOLVO	B 58		
				B 58 BR (...Chassi 304120)		
		FIAT	190 (77...)			
		MERCEDES BENZ	331 (L*LPK*LPS) 60...68			
			L 331			
	LPK 331 * LP S331					
	SCANIA	R 142 MA (4X2)(81...)				
		T 142 E (6X4)				
	VOLVO	N * NL 10 BR * N * NL 12 BR * N 10BR Mark II * NL 10BR 6x2				
		N * NL 10 BR * N * NL 12 BR * N 10BR Mark II * NL 10BR 6x2				







Fersa®			Brand / Marca / Marca	Model / Modelo / Modelo	Application / Aplicação / Aplicaciones
32220 F	TRB		SCANIA	110 (L*LS)	Eixo Traseiro / Eje Trasero / Rear Axle
				111 (L*LS*LT)	
				140 (LK*LKS)	
				K 124 CA (6x4 * 6x2)	
32304 F	TRB		MERCEDES BENZ	608 D * E (L*LO) * 708 D * E (L*LO) * 709 L * 710 L * 712 L	Tomada de Potência / Toma de Potencia / Power Take-off
			FIAT	FNM 2000 * 2150	Eixo Dianteiro / Eje Delantero / Front Axle
			MERCEDES BENZ	608 (L*LO) * 708 (L*LO) * 809 (LO*OF) * 812 (LO*OF) * 814 LO * 817 O * 914 LO * 709 * 710 * 712 * 712 C * 811 * 911 L * 912 * 913 * 914 * 914 C * 917	Tomada de Potência / Toma de Potencia / Power Take-off
			ALFA ROMEO	Alfa 2300	Eixo Dianteiro / Eje Delantero / Front Axle
FORD	Belina * Belina II * Corcel * Corcel II		Câmbio / Caja de Cambios / Gearbox		
	Belina I (...78) * Corcel I (...78)		Motor / Motor / Engine		
	Belina II (79...) * Corcel II (79...)	Câmbio / Caja de Cambios / Gearbox			
32305 F	TRB		MERCEDES BENZ	608 D * E (L*LO) * 708 D * E (L*LO) * 709 L * 710 L * 712 L	Tomada de Potência / Toma de Potencia / Power Take-off
			MERCEDES BENZ	608 (L*LO) * 708 (L*LO) * 809 (LO*OF) * 812 (LO*OF) * 814 LO * 817 O * 914 LO * 709 * 710 * 712 * 712 C * 811 * 911 L * 912 * 913 * 914 * 914 C * 917	Tomada de Potência / Toma de Potencia / Power Take-off
			MERCEDES BENZ	312 (L*LK*LP) 51...58	Tomada de Força / Toma de Fuerza / Power Take-off
			MERCEDES BENZ	312 (L*LK*LP) 51...58	Tomada de Potência / Toma de Potencia / Power Take-off
32306 F	TRB		MERCEDES BENZ	1113 (LPO*OH) * 1114 LPO * 1115 L (OH) * 1118 LPO	Eixo Dianteiro / Eje Delantero / Front Axle
				608 D * E (L*LO) * 708 D * E (L*LO) * 709 L * 710 L * 712 L	Tomada de Potência / Toma de Potencia / Power Take-off
				812 LO * 912 L	Eixo Dianteiro / Eje Delantero / Front Axle
				O 817	Eixo Dianteiro / Eje Delantero / Front Axle
				101 (L*LS) * 111 (B) * 111 Articulado (B)	Tomada de Força / Toma de Fuerza / Power Take-off
				110 (B)	
				110 (L*LS)	
		111 (L*LS*LT)			
			MERCEDES BENZ	115 * 116 BR	Tomada de Potência / Toma de Potencia / Power Take-off
				140 (LK*LKS)	Tomada de Potência / Toma de Potencia / Power Take-off
				P 93 * R 113 * R 143 * T 113	Eixo Dianteiro / Eje Delantero / Front Axle
				608 (L*LO) * 708 (L*LO) * 809 (LO*OF) * 812 (LO*OF) * 814 LO * 817 O * 914 LO * 709 * 710 * 712 * 712 C * 811 * 911 L * 912 * 913 * 914 * 914 C * 917	Tomada de Potência / Toma de Potencia / Power Take-off
				1113 (L*LA*LAK*LAS*LK*LP*LS*LP) * 1114 * 1114 (L*LK*LP) * 1116 (L*LA*LAK*LAS*LB*LK*LS) * 1118 (L*LK*LP)	Tomada de Potência / Toma de Potencia / Power Take-off
				1113 OF * 1115 OF	Eixo Dianteiro / Eje Delantero / Front Axle
312 (L*LK*LP) 51...58	Tomada de Força / Toma de Fuerza / Power Take-off				
312 (L*LK*LP) 51...58	Tomada de Potência / Toma de Potencia / Power Take-off				









Fersa*			Brand / Marca / Marca	Model / Modelo / Modelo	Application / Aplicação / Aplicaciones					
32306 F	TRB		MERCEDES BENZ	L 1312	Eixo Dianteiro / Eje Delantero / Front Axle					
				L 608 * L 708 * L 709 * L 710 * L 712 * L 714 * L 715 * L 718						
				L809 * L812 * L814 * L817						
				L 911 * L 912 * L 913 * L 914						
				LK 312						
				LO 608 * LO 708						
				LO 709 * LO 710 * LO 712						
				LO 914						
				LP 1312						
				112 (F*K*S)		Tomada de Força / Toma de Fuerza / Power Take-off				
		F 113 * L 113 * K 113								
		R 112 (81...)								
		R 142 MA (4X2)(81...)								
		T 142 E (6X4)								
			MERCEDES BENZ	1113 OF * 1115 OF	Eixo Dianteiro / Eje Delantero / Front Axle					
LO 709 * LO 710 * LO 712										
LO 914										
32307 F	TRB		MERCEDES BENZ	1113 (LPO*OH) * 1114 LPO * 1115 L (OH) * 1118 LPO	Eixo Dianteiro / Eje Delantero / Front Axle					
				1313 OH * 1314 OH * 1315 OH * 1316 (OH*OHL) * 1316 G (OH*OHL) * 1317 OH * 1318 OH * 1319 OH * 1320 (OH*OHL)						
				1517 OH * 1518 OH * 1519 OH * 1520 OH * 1521 OH						
				321 H (O) * 321 HL (O) (58...71)						
				326 O						
				352 HL (O) (...74)						
				355 O						
				OH 1517 * OH 1518 * OH 1519 * OH 1520 * OH 1521						
				GENERAL MOTORS		6-100 (4X2)* 6-150* 12-170 L*S (4X2) * 14-190 (77...) (4X2)* 15-190 (77...) (4X2)* 16-220 (4X2)				
						1018 MBO				
						1111 (L*LA*LAK*LAS*LK*LS)				
						1113 (L*LA*LAK*LAS*LK*LP*LS*LP) * 1114 * 1114 (L*LK*LP) * 1116 (L*LA*LAK*LAS*LB* LK*LS) * 1118 (L*LK*LP)				
						1113 OF * 1115 OF				
						1313 (L*LA*LAK*LB*LK*LS) * 1314 (L*LA*LAK*LB*LK*LS) * 1316 (L*LA*LAK*LAS*LB*LK*LS) * 1317 (L*LA*LAK*LK*LS)* 1319 (L)				
						1313 OF * 1314 OF * 1315 OF * 1316 OF * 1317 OF * 1318 OF * 1319 OF * 1320 OF				
		1513 (L*LA*LAK*LB*LG*LK*LS) * 1514 (L*LK*LS) * 1516 (L*LA*LAK*LB*LG*LK*LS) * 1517 (L*LK) * 1518 (L*LK*LS) * 1519 (L*LAK*LB*LG*LK*LS) * 1520 (L*LK*LP*LPK*LPS*LS) * 1521 L * 1524 e 1525 (L*LK*LS)								
		1517 OF * 1518 OF * 1520 OF								
		2013 (L*LA*LAK*LB*LG*LK*LS) * 2013 6X2 (L) * 2014 (L*LB*LK) * 2016 (LB*LK) * 2017 (L*LB*LK)								
		2213 (L*LB*LK*LS) * 2213 6X6 (LA) * 2214 * 2215 (L*LB*LK*LS) * 2216 (L*LA*LAK*LB*LG*LK*LS) * 2217 (L*LB*LK*LS) * 2219 (L*LA*LAK*LB*LG*LK*LS) * 2220 * 2222 * 2225 (L*LB*LK*LS)								
		312 (L*LK*LP) 51...58								
		321 (LAP*LAPK*LAPS*LP* LPK*LPS) 51...71								
		321 LAP * LAPK * LAPS * LP * LPK * LPS								
		LA 2213 6X6 * LA 2214 6X6 * LA 2215 6X6 * LA 2216 6X6 * LA 2217 6X6 * LA 2219 6X6 * LA 2220 6X6 * LA 2225 6X6								
		LK 1113 * LK 1114 * LK 1116 * LK 1117 * LK 1118								
			MERCEDES BENZ	1018 MBO						
				1113 OF * 1115 OF						
				1313 OF * 1314 OF * 1315 OF * 1316 OF * 1317 OF * 1318 OF * 1319 OF * 1320 OF						
				1517 OF * 1518 OF * 1520 OF						
				32308 BF		TRB		SCANIA	K 124 CA (6x4 * 6x2)	Eixo Dianteiro / Eje Delantero / Front Axle Eixo Traseiro / Eje Trasero / Rear Axle











Fersa®			Brand / Marca / Marca	Model / Modelo / Modelo	Application / Aplicação / Aplicações			
32308 BF	TRB		SCANIA	P 114 * R 124 * T 114 CB 6x4 * 4x2 * T 124	Eixo Traseiro / Eje Trasero / Rear Axle			
				P 94 CB (4x2 * 6x2 * 6X4)	Eixo Dianteiro / Eje Delantero / Front Axle			
				94I * 94H * 94U * P94 CB (6x4*4x2) * 114L * P114 * T114 CB (6x4*4x2) * 124E * R124 * K124 CA (6x4*6x2) * T124 * P124 CA * CB (6x4*4x2) * 164 * P230 * P270 * P310 * P340 * P420 * R380 * R420 * R480	Eixo Traseiro / Eje Trasero / Rear Axle			
32308 F	TRB		SCANIA	101 (L*LS) * 111 (B) * 111 Articulado (B)	Eixo Dianteiro / Eje Delantero / Front Axle			
				110 (B)				
				110 (L*LS)				
				115 * 116 BR				
				140 (LK*LKS)				
				K 124 CA 4x2 NB 340K				
				K 124 CA (6x4 * 6x2)				
				P 93 * R 113 * R 143 * T 113	Eixo Traseiro / Eje Trasero / Rear Axle			
				T 113 H (6X4) Paradiso	Eixo Dianteiro / Eje Delantero / Front Axle			
				130 OD (78...)				
				70 (77...) * 80				
				TRB		SCANIA	FNM 210 C * CM * LN (71...76)	Eixo Dianteiro / Eje Delantero / Front Axle
							112 (F*K*S)	
							75 * 76 B*L*LS	
	F 113 * L 113 * K 113	Eixo Traseiro / Eje Trasero / Rear Axle						
	P 114 * R 124 * T 114 CB 6x4 * 4x2 * T 124	Eixo Dianteiro / Eje Delantero / Front Axle						
	P 94 CB (4x2 * 6x2 * 6X4)							
	P 94 DB 4X2 NA 220 * P 94 DB 6X2 NA260							
	94I * 94H * 94U * P94 CB (6x4*4x2) * 114L * P114 * T114 CB (6x4*4x2) * 124E * R124 * K124 CA (6x4*6x2) * T124 * P124 CA * CB (6x4*4x2) * 164 * P230 * P270 * P310 * P340 * P420 * R380 * R420 * R480							
	R 112 (81...)							
	R 124 GA 4X2 NA400							
R 142 MA (4X2)(81...)								
Série 4 (4X2)								
T 124 GA 6X4 * T 124 LA 6X4 NA400								
T 142 E (6X4)								
32309 F	TRB		MERCEDES BENZ	1517 OH * 1518 OH * 1519 OH * 1520 OH * 1521 OH	Eixo Dianteiro / Eje Delantero / Front Axle			
				1621 L (OH) * 1623 LG (OH) * 1625 (OH) * 1625 L (OH) * 1628 L (OH) * 1630L (OH) * 1635 (OH) * 1636 L (OH)	Caixa de Mudanças / Caja de Cambios / Gearbox			
				1721 L (OH)				
				370 RS*RSD*RST* ST*U*UP (O) * 371 RS*RSD*RST* ST*U*UP (O)				
				400 (R * RS * RSD * RSL) (O)				
				500 (O*M* R)				
				Multego IBC 1842 * IBC 2242 * OC 500				
				O 371 R * O 371 RS * O 371 RSD				
				O 400 R * O 400 RS * O 400 RSD * O 400 RSE * O 400 RSL * MP 105 * MP 108 DD * MP120 * MP 180 DD				
				140 (LK*LKS)	Eixo Dianteiro / Eje Delantero / Front Axle			
				K 113	Eixo Traseiro / Eje Trasero / Rear Axle			
				K 124 CA (6x4 * 6x2)	Eixo Dianteiro / Eje Delantero / Front Axle			
				P 93 * R 113 * R 143 * T 113	Eixo Traseiro / Eje Trasero / Rear Axle			
				T 113 H (6X4) Paradiso				
	TRB		VOLVO	B 10M BR	Caixa de Mudanças / Caja de Cambios / Gearbox			
				B 10R * B 12B * B 12R * B 58 * B 58BR * B 7R * B9				
				B 58				
				B 58 BR (...Chassi 304120)				







Fersa®			Brand / Marca / Marca	Model / Modelo / Modelo	Application / Aplicação / Aplicaciones			
32309 F	TRB		FIAT	180 C * C3 * L * N * N3 (71...) 190 (77...)	Eixo Dianteiro / Eje Delantero / Front Axle			
			MERCEDES BENZ	1513 (L*LA*LAK*LB*LG*LK*LS) * 1514 (L*LK*LS) * 1516 (L*LA*LAK*LB*LG*LK*LS) * 1517 (L*LK) * 1518 (L*LK*LS) * 1519 (L*LAK*LB*LG*LK*LS) * 1520 (L*LK*LP*LPK*LPS*LS) * 1521 L * 1524 e 1525 (L*LK*LS) 1517 OF * 1518 OF * 1520 OF 1614 * 1615 (L*LK*LS) * 1615 * 1618 M * 1618 (L*LK*LS) * 1619 (L) 1614 * 1615 (L*LK*LS) * 1615 * 1618 M * 1618 (L*LK*LS) * 1619 (L) 1618 OF 1620(L*LK*LS) * 1620 6X2 51 (L) * 1621 (L*LK*LS) * 1622(L*LK*LS) * 1623 (L*LS) * 1625(L*LK*LS) * 1630 (L*LK*LS) * 1632 (L*LS) * 1633(L*LK*LS) * 1634 (L*LS) * 1635 L 1620 OF * 1621 OF 1714 OF * 1721 OF * 1722 OF 1714 * 1714 (L*K*LK) * 1715 * 1718 * 1718 (A * AK) * K * 1720 L * 1721 * 1721 S * 1721 (L*LK) * 1722 S * 1723 * 1723 S * 1725 L 1924 (LS) * 1924 A (LS) * 1929 (L*LK*LS) * 1930 (LS) * 1932 (LS) * 1933 (LS) * 1934 (LS) * 1935 (L*LS) * 1938 * 1938 S * 1938 (L*LS) * 1941 (L*LS) * 1944 S * 1945 (L*LS) 2213 (L*LB*LK*LS) * 2213 6X6 (LA) * 2214 * 2215 (L*LB*LK*LS) * 2216 (L*LA*LAK*LB*LG*LK*LS) * 2217 (L*LB*LK*LS) * 2219 (L*LA*LAK*LB*LG*LK*LS) * 2220 * 2222 * 2225 (L*LB*LK*LS)		Caixa de Mudanças / Caja de Cambios / Gearbox		
				331 (L*LPK*LPS) 60...68			Eixo Dianteiro / Eje Delantero / Front Axle	
				L1924 * L1929 * L1930 * L1932 * L1933 * L1934 * L1935 * L1937 * L1938 * L1939 * L1941 * L1942 * L1944 * L1945 * L1951 L 331			Caixa de Mudanças / Caja de Cambios / Gearbox	
				LP 1520 * LPK1520 * LPS1520			Eixo Dianteiro / Eje Delantero / Front Axle	
				LPK 331 * LP S331				
				112 (F*K*S)	Eixo Traseiro / Eje Trasero / Rear Axle			
				F 113 * L 113 * K 113				
				SCANIA	P 114 * R 124 * T 114 CB 6x4 * 4x2 * T 124		Eixo Dianteiro / Eje Delantero / Front Axle	
					P 114 GA (4X2) * R 114 GA (4X2 * 6X4) * T 114 GA (4X2) * T 114 LA (6X2)		Eixo Traseiro / Eje Trasero / Rear Axle	
					P 94 CB (4x2 * 6x2 * 6X4)		Eixo Dianteiro / Eje Delantero / Front Axle	
					94I * 94H * 94U * P94 CB (6x4*4x2) * 114L * P114 * T114 CB (6x4*4x2) * 124E * R124 * K124 CA (6x4*6x2) * T124 * P124 CA * CB (6x4*4x2) * 164 * P230 * P270 * P310 * P340 * P420 * R380 * R420 * R480 R 112 (81...) R 142 MA (4X2)(81...) T 142 E (6X4)			
					1517 OF * 1518 OF * 1520 OF			Caixa de Mudanças / Caja de Cambios / Gearbox
					1618 OF			
					1620 OF * 1621 OF 1714 OF * 1721 OF * 1722 OF			
				MERCEDES BENZ	1621 L (OH) * 1623 LG (OH) * 1625 (OH) * 1625 L (OH) * 1628 L (OH) * 1630L (OH) * 1635 (OH) * 1636 L (OH) 1721 L (OH) 370 RS*RSD*RST* ST*U*UP (O) * 371 RS*RSD*RST* ST*U*UP (O) 400 (R * RS * RSD * RSL) (O) 500 (O*M* R) Multego IBC 1842 * IBC 2242 * OC 500 O 371 R * O 371 RS * O 371 RSD O 400 R * O 400 RS * O 400 RSD * O 400 RSE * O 400 RSL * MP 105 * MP 108 DD * MP120 * MP 180 DD O500M 1728 * O500R 1735		Caixa de Mudanças / Caja de Cambios / Gearbox	
			32310 F	TRB		MERCEDES BENZ	1621 L (OH) * 1623 LG (OH) * 1625 (OH) * 1625 L (OH) * 1628 L (OH) * 1630L (OH) * 1635 (OH) * 1636 L (OH) 1721 L (OH) 370 RS*RSD*RST* ST*U*UP (O) * 371 RS*RSD*RST* ST*U*UP (O) 400 (R * RS * RSD * RSL) (O) 500 (O*M* R) Multego IBC 1842 * IBC 2242 * OC 500 O 371 R * O 371 RS * O 371 RSD O 400 R * O 400 RS * O 400 RSD * O 400 RSE * O 400 RSL * MP 105 * MP 108 DD * MP120 * MP 180 DD O500M 1728 * O500R 1735	Caixa de Mudanças / Caja de Cambios / Gearbox
							Eixo Dianteiro / Eje Delantero / Front Axle	





Fersa®			Brand / Marca / Marca	Model / Modelo / Modelo	Application / Aplicação / Aplicaciones
32310 F	TRB		MERCEDES BENZ	1614 * 1615 (L*LK*LS) * 1615 * 1618 M * 1618 (L*LK*LS) * 1619 (L)	Caixa de Mudanças / Caja de Cambios / Gearbox Eixo Dianteiro / Eje Delantero / Front Axle
				1618 OF	Caixa de Mudanças / Caja de Cambios / Gearbox Eixo Dianteiro / Eje Delantero / Front Axle
				1620(L*LK*LS) * 1620 6X2 51 (L) * 1621 (L*LK*LS) * 1622(L*LK*LS) * 1623 (L*LS) * 1625(L*LK*LS) * 1630 (L*LK*LS) * 1632 (L*LS) * 1633(L*LK*LS) * 1634 (L*LS) * 1635 L	Caixa de Mudanças / Caja de Cambios / Gearbox
				1620 OF * 1621 OF	
				1714 OF * 1721 OF * 1722 OF	Eixo Dianteiro / Eje Delantero / Front Axle
				1714 * 1714 (L*K*LK) * 1715 * 1718 * 1718 (A * AK) * K * 1720 L * 1721 * 1721 S * 1721 (L*LK) * 1722 S * 1723 * 1723 S * 1725 L	Caixa de Mudanças / Caja de Cambios / Gearbox Eixo Dianteiro / Eje Delantero / Front Axle
				1924 (LS) * 1924 A (LS) * 1929 (L*LK*LS) * 1930 (LS) * 1932 (LS) * 1933 (LS) * 1934 (LS) * 1935 (L*LS) * 1938 * 1938 S * 1938 (L*LS) * 1941 (L*LS) * 1944 S * 1945 (L*LS)	Caixa de Mudanças / Caja de Cambios / Gearbox
				2013 (L*LA*LAK*LB*LG*LK*LS) * 2013 6X2 (L) * 2014 (L*LB*LK) * 2016 (LB*LK) * 2017 (L*LB*LK)	Eixo Dianteiro / Eje Delantero / Front Axle
				2414 (6X4) * 2414 (L) * 2418 (L*LB*LK) * 2420 (L*LB*LK) * 2423 B 6X4 * 2423 K 6X4 * 2425 6X6 (LA) * 2425 (L*LB*LK) * 2428 6X4	Eixo Traseiro / Eje Trasero / Rear Axle
				2629 LS	Caixa de Mudanças / Caja de Cambios / Gearbox Eixo Dianteiro / Eje Delantero / Front Axle
				2635 (L*LK*LS)	Caixa de Mudanças / Caja de Cambios / Gearbox
				L1618	
				L1621 54 * L1621 59 * L1621 60 * L1621 70 * L1622 * L1623 * L1625	
				L1630 * L1632 * L1633 * L1634	
				L 1614 * L 1615	
				L 1620	
				L 1714 * L 1715 * L 1718 * L 1720 * L 1721 * L 1722 * L 1723 * L 1724 * L 1728	Eixo Dianteiro / Eje Delantero / Front Axle
				LK 1614 * LK 1615 * LK 1617 * LK 1618 * LK 1620 * LK 1621 * LK 1622 * LK 1623 * LK 1625 * LK 1630 * LK 1633 * LK 1634	
		LK 1714 * LK 1715 * LK 1718 * LK 1720 * LK 1721 * LK 1722 * LK 1723 * LK 1724 * LK 1728			
		OF 1517 * OF 1518 * OF 1519 * OF 1520 * OF 1521 * OF 1524 * OF 1525			
		OF 1618 * OF 1620 * OF 1621 * OF 1625 * OF 1628 * OF 1630 * OF 1635 * OF 1636			
		OF 1714 * OF 1718 * OF 1721 * OF 1725			
		VOLVO	N * NL 10 BR * N * NL 12 BR * N 10BR Mark II * NL 10BR 6x2	Embreagem / Embrague / Clutch	
			MERCEDES BENZ	1618 OF	Caixa de Mudanças / Caja de Cambios / Gearbox Eixo Dianteiro / Eje Delantero / Front Axle
				1620 OF * 1621 OF	Caixa de Mudanças / Caja de Cambios / Gearbox
				1714 OF * 1721 OF * 1722 OF	
				OF 1517 * OF 1518 * OF 1519 * OF 1520 * OF 1521 * OF 1524 * OF 1525	Eixo Dianteiro / Eje Delantero / Front Axle
				OF 1618 * OF 1620 * OF 1621 * OF 1625 * OF 1628 * OF 1630 * OF 1635 * OF 1636	
OF 1714 * OF 1718 * OF 1721 * OF 1725					
32311 F	TRB		SCANIA	101 (L*LS) * 111 (B) * 111 Articulado (B)	
				110 (B)	
				110 (L*LS)	
				115 * 116 BR	Eixo Dianteiro / Eje Delantero / Front Axle
				140 (LK*LKS)	
				K 124 CA (6x4 * 6x2)	
P 93 * R 113 * R 143 * T 113	Eixo Traseiro / Eje Trasero / Rear Axle				









Fersa*			Brand / Marca / Marca	Model / Modelo / Modelo	Application / Aplicação / Aplicaciones	
32311 F	TRB		FIAT	130 OD (78...)	Eixo Dianteiro / Eje Delantero / Front Axle	
				70 (77...) * 80		
				FNM 210 C * CM * LN (71...76)		
			SCANIA	112 (F*K*S)		Eixo Traseiro / Eje Trasero / Rear Axle
				75 * 76 B*L*LS		
				F 113 * L 113 * K 113		
				P 114 * R 124 * T 114 CB 6x4 * 4x2 * T 124		
				P 94 CB (4x2 * 6x2 * 6X4)		
				R 112 (81...)		
				R 142 MA (4X2)(81...)		
T 142 E (6X4)						
32312 F	TRB		SCANIA	140 (LK*LKS)	Eixo Traseiro / Eje Trasero / Rear Axle	
				K 113	Eixo Dianteiro / Eje Delantero / Front Axle	
				K 124 CA (6x4 * 6x2)		
				P 93 * R 113 * R 143* T 113		
				T 113 H (6X4) Paradiso		
				Eixo Traseiro / Eje Trasero / Rear Axle		
			VOLVO	7550	Caixa de Mudanças / Caja de Cambios / Gearbox	
				9700		
			FIAT	130 OD (78...)	Eixo Dianteiro / Eje Delantero / Front Axle	
				180 C * C3 * L * N * N3 (71...)	Eixo Traseiro / Eje Trasero / Rear Axle	
		190 (77...)		Eixo Dianteiro / Eje Delantero / Front Axle		
		FNM D-11000 (58...72)		Eixo Traseiro / Eje Trasero / Rear Axle		
		MERCEDES BENZ		1924 (LS) * 1924 A (LS) * 1929 (L*LK*LS) * 1930 (LS) * 1932 (LS) * 1933 (LS) * 1934 (LS) * 1935 (L*LS) * 1938 * 1938 S * 1938 (L*LS) * 1941 (L*LS) * 1944 S * 1945 (L*LS) Axor 2625 * 2628 * 2629 (LK*LS) * 2631 (B*K*L) * 2632 * 2635 (B*K*L) * 2635 (L*LK*LS) * 2635 * 2638 (L*LK*LS) * Axor 2640 * 2641 * 2643 * Axor 2644 * Actos 2646 * 2648 * 2650 * 2651 * 2653 * 2654 (L*LK*LS) * 2657 * 2658 * 2644 * Atego 2628 (B*K) * 2625 * Axor 2826 * Axor 2828 * Axor 2831 3238 (6x4) K*S	Eixo Dianteiro / Eje Delantero / Front Axle	
				112 (F*K*S)	Eixo Traseiro / Eje Trasero / Rear Axle	
				F 113 * L 113 * K 113		
				P 114 * R 124 * T 114 CB 6x4 * 4x2 * T 124		
				P 114 GA (4X2) * R 114 GA (4X2 * 6X4) * T 114 GA (4X2) * T 114 LA (6X2)		
				P 94 CB (4x2 * 6x2 * 6X4)		
			94I * 94H * 94U * P94 CB (6x4*4x2) * 114L * P114 * T114 CB (6x4*4x2) * 124E * R124 * K124 CA (6x4*6x2) * T124 * P124 CA * CB (6x4*4x2) * 164 * P230 * P270 * P310 * P340 * P420 * R380 * R420 * R480			
			R 112 (81...)			
R 142 MA (4X2)(81...)						
T 142 E (6X4)						
FIAT	180 C * C3 * L * N * N3 (71...)	Eixo Traseiro / Eje Trasero / Rear Axle				
32313 BF	TRB		SCANIA	K 94 IB (4X2)	Eixo Traseiro / Eje Trasero / Rear Axle	
			SCANIA	75 * 76 B*L*LS	Eixo / Eje / Axle	
		P 94 CB (4x2 * 6x2 * 6X4)		Eixo Traseiro / Eje Trasero / Rear Axle		
P 94 GA*GB (4X2)						
32313 F	TRB		FIAT	190 (77...)	Eixo Traseiro / Eje Trasero / Rear Axle	
				FNM 210 C * CM * LN (71...76)		
			MERCEDES BENZ	2635 (L*LK*LS)		













Fersa®			Brand / Marca / Marca	Model / Modelo / Modelo	Application / Aplicação / Aplicaciones
32314 BF	TRB		MERCEDES BENZ	1621 L (OH) * 1623 LG (OH) * 1625 (OH) * 1625 L (OH) * 1628 L (OH) * 1630L (OH) * 1635 (OH) * 1636 L (OH) 1721 L (OH) 370 RS*RSD*RST* ST*U*UP (O) * 371 RS*RSD*RST* ST*U*UP (O) O500M 1728 * O500R 1735 O 362HL O 371 U * O 371 UL * O 371 UP	Eixo Traseiro / Eje Trasero / Rear Axle
			MERCEDES BENZ	1614 * 1615 (L*LK*LS) * 1615 * 1618 M * 1618 (L*LK*LS) * 1619 (L) 1618 OF 1620(L*LK*LS) * 1620 6X2 51 (L) * 1621 (L*LK*LS) * 1622(L*LK*LS) * 1623 (L*LS) * 1625(L*LK*LS) * 1630 (L*LK*LS) * 1632 (L*LS) * 1633(L*LK*LS) * 1634 (L*LS) * 1635 L 1620 OF * 1621 OF 1714 OF * 1721 OF * 1722 OF 1714 * 1714 (L*K*LK) * 1715 * 1718 * 1718 (A * AK) * K * 1720 L * 1721 * 1721 S * 1721 (L*LK) * 1722 S * 1723 * 1723 S * 1725 L 1924 (LS) * 1924 A (LS) * 1929 (L*LK*LS) * 1930 (LS) * 1932 (LS) * 1933 (LS) * 1934 (LS) * 1935 (L*LS) * 1938 * 1938 S * 1938 (L*LS) * 1941 (L*LS) * 1944 S * 1945 (L*LS) Axor 2625 * 2628 * 2629 (LK*LS) * 2631 (B*K*L) * 2632 * 2635 (B*K*L) * 2635 (L*LK*LS) * 2635 * 2638 (L*LK*LS) * Axor 2640 * 2641 * 2643 * Axor 2644 * Actos 2646 * 2648 * 2650 * 2651 * 2653 * 2654 (L*LK*LS) * 2657 * 2658 * 2644 * Atego 2628 (B*K) * 2625 * Axor 2826 * Axor 2828 * Axor 2831 2635 (L*LK*LS) L1617 59 L1618 L1630 * L1632 * L1633 * L1634 L 1614 * L 1615 L 1620 LK 1614 * LK 1615 * LK 1617 * LK 1618 * LK 1620 * LK 1621 * LK 1622 * LK 1623 * LK 1625 * LK 1630 * LK 1633 * LK 1634 LK 2629 * LK 2635 * LK 2638 * LK 2654 LK 3238 6X4 KS LS 1929 * LS 1930 * LS 1932 * LS 1933 * LS 1934 * LS 1935 * LS 1937 * LS 1938 * LS 1939 * LS 1941 * LS 1942 * LS 1944 * LS 1945 * LS 1951 LS 2629 * LS 2635 * LS 2638 * LS 2654 OF 1618 * OF 1620 * OF 1621 * OF 1625 * OF 1628 * OF 1630 * OF 1635 * OF 1636	
32315 BF	TRB		SCANIA	101 (L*LS) * 111 (B) * 111 Articulado (B) 110 (B) 110 (L*LS) 111 (L*LS*LT) 115 * 116 BR 140 (LK*LKS)	Eixo Traseiro / Eje Trasero / Rear Axle
			SCANIA	112 (F*K*S) R 112 (81...) R 142 MA (4X2)(81...) T 142 E (6X4)	
32315 F	TRB		FIAT	190 (77...) FNM 210 C * CM * LN (71...76)	Eixo Traseiro / Eje Trasero / Rear Axle
32316 F	TRB		SCANIA	110 (L*LS) 111 (L*LS*LT) 140 (LK*LKS) K 124 CA (6x4 * 6x2)	Eixo Traseiro / Eje Trasero / Rear Axle
			SCANIA	P 114 * R 124 * T 114 CB 6x4 * 4x2 * T 124 P 94 CB (4x2 * 6x2 * 6X4) 941 * 94H * 94U * P94 CB (6x4*4x2) * 114L * P114 * T114 CB (6x4*4x2) * 124E * R124 * K124 CA (6x4*6x2) * T124 * P124 CA * CB (6x4*4x2) * 164 * P230 * P270 * P310 * P340 * P420 * R380 * R420 * R480	





Fersa*			Brand / Marca / Marca	Model / Modelo / Modelo	Application / Aplicação / Aplicaciones																																				
33011 F	TRB		MERCEDES BENZ	1313 OH * 1314 OH * 1315 OH * 1316 (OH*OHL) * 1316 G (OH*OHL) * 1317 OH * 1318 OH * 1319 OH * 1320 (OH*OHL)	Caixa de Mudanças / Caja de Cambios / Gearbox																																				
				1313 OH * 1314 OH * 1315 OH * 1316 (OH*OHL) * 1316 G (OH*OHL) * 1317 OH * 1318 OH * 1319 OH * 1320 (OH*OHL)																																					
				608 D * E (L*LO) * 708 D * E (L*LO) * 709 L * 710 L * 712 L 812 LO * 912 L																																					
		33011 F	TRB		MERCEDES BENZ	608 (L*LO) * 708 (L*LO) * 809 (LO*OF) * 812 (LO*OF) * 814 LO * 817 O * 914 LO * 709 * 710 * 712 * 712 C * 811 * 911 L * 912 * 913 * 914 * 914 C * 917	Eixo Traseiro / Eje Trasero / Rear Axle																																		
						1313 (L*LA*LAK*LB*LK*LS) * 1314 (L*LA*LAK*LB*LK*LS) * 1316 (L*LA*LAK*LAS*LB*LK*LS) * 1317 (L*LA*LAK*LK*LS) * 1319 (L)																																			
						1313 OF * 1314 OF * 1315 OF * 1316 OF * 1317 OF * 1318 OF * 1319 OF * 1320 OF																																			
						33011 F	TRB		MERCEDES BENZ	1819 (L*LAK*LB*LG*LK*LS) * 1820 LG 1819 (L*LAK*LB*LG*LK*LS) * 1820 LG	Caixa de Mudanças / Caja de Cambios / Gearbox																														
										2213 (L*LB*LK*LS) * 2213 6X6 (LA) * 2214 * 2215 (L*LB*LK*LS) * 2216 (L*LA*LAK*LB*LG*LK*LS) * 2217 (L*LB*LK*LS) * 2219 (L*LA*LAK*LB*LG*LK*LS) * 2220 * 2222 * 2225 (L*LB*LK*LS)																															
										2314 (L*LB*LK*LS) * 2318 (L*LB*LK*LS) * 2325 (L*LB*LK*LS)																															
										33011 F		TRB		MERCEDES BENZ	2414 (6X4) * 2414 (L) * 2418 (L*LB*LK) * 2420 (L*LB*LK) * 2423 B 6X4 * 2423 K 6X4 * 2425 6X6 (LA) * 2425 (L*LB*LK) * 2428 6X4	Caixa de Mudanças / Caja de Cambios / Gearbox																									
															L 2213 * L 2214 * L 2215 * L 2216 * L 2217 * L 2219 * L 2220 L 2222 * L 2225 * L 2314 * L 2318 * L 2325 L 331																										
															L 911 * L 912 * L 913 * L 914																										
															33011 F		TRB		MERCEDES BENZ	LA 1313 * LA 1314 * LA 1315 * LA 1316 * LA 1317 * LA 1318 * LA 1319 * LA 1320	Caixa de Mudanças / Caja de Cambios / Gearbox																				
																				LA 2213 6X6 * LA 2214 6X6 * LA 2215 6X6 * LA 2216 6X6 * LA 2217 6X6 * LA 2219 6X6 * LA 2220 6X6 * LA 2225 6X6																					
																				LAK 1313 * LAK 1314 * LAK 1315 * LAK 1316 * LAK 1317 * LAK 1318 * LAK 1320																					
																				33011 F		TRB		MERCEDES BENZ	LAK 2213 * LAK 2214 * LAK 2215 * LAK 2216 * LAK 2217 * LAK 2219 * LAK 2220 * LAK 2222 * LAK 2225	Caixa de Mudanças / Caja de Cambios / Gearbox															
																									LAS 1313 * LAS 1314 * LAS 1315 * LAS 1316 * LAS 1317 * LAS 1318 * LAS 1319 * LAS 1320																
																									LB 2220 * LB 2222 * LB 2225																
																									33011 F		TRB		MERCEDES BENZ	LB 2314 * LB 2318 * LB 2325 LG 1819 * LG 1820	Caixa de Mudanças / Caja de Cambios / Gearbox										
																														LK 1313 * LK 1314 * LK 1315 * LK 1316 * LK 1317 * LK 1318 * LK 1319 * LK 1320 * LK 1321											
																														LK 2213 * LK 2214 * LK 2215 * LK 2216 * LK 2217 * LK 2219 * LK 2220 * LK 2222 * LK 2225											
																														33011 F		TRB		MERCEDES BENZ	LK 2314 * LK 2318 * LK 2325 LO 709 * LO 710 * LO 712 LPK 331 * LP S331	Caixa de Mudanças / Caja de Cambios / Gearbox					
																																			LS 2220 * LS 2222 * LS 2225 * LS 2314 * LS 2325						
																																			1313 OF * 1314 OF * 1315 OF * 1316 OF * 1317 OF * 1318 OF * 1319 OF * 1320 OF						
																																			33017 F		TRB		SCANIA	111 (L*LS*LT)	Eixo Traseiro / Eje Trasero / Rear Axle
																																								K 114 IB (4X2) Busscar	
																																								K 114 IB (4X2) LB 340 Irizar	
																																								K 114 IB 4X2 NB 340 K	
																																								K 124 CA (6x4 * 6x2)	
																																								K 124 IB 4X2 Vissta Bus	
																																							VOLVO	L 114 IB (4X2) LB 340 Urbanuss	
																																								L 94 VB (4X2) 220HP Urbanuss	
																																								7550	
SCANIA	9700																																								
	LA 94 UB 4X2 LB * LA 6X4 NA																																								
	P 114 * R 124 * T 114 CB 6x4 * 4x2 * T 124																																								
	P 114 CB 6X4 NA 340																																								
	P 94 CB (4x2 * 6x2 * 6X4)																																								







Fersa®			Brand / Marca / Marca	Model / Modelo / Modelo	Application / Aplicação / Aplicaciones		
33017 F	TRB		SCANIA	941 * 94H * 94U * P94 CB (6x4*4x2) * 114L * P114 * T114 CB (6x4*4x2) * 124E * R124 * K124 CA (6x4*6x2) * T124 * P124 CA * CB (6x4*4x2) * 164 * P230 * P270 * P310 * P340 * P420 * R380 * R420 * R480	Eixo Traseiro / Eje Trasero / Rear Axle		
				R 112 (81...)			
				R 124 GA 4X2 NA400			
				R 142 MA (4X2)(81...)			
				Série 4 (4X2)			
T 124 GA 6X4 * T 124 LA 6X4 NA400							
33018 F	TRB		SCANIA	K 124 CA 4x2 NB 340K	Eixo Traseiro / Eje Trasero / Rear Axle		
				K 124 CA (6x4 * 6x2)			
			SCANIA	P 114 * R 124 * T 114 CB 6x4 * 4x2 * T 124			
				P 114 CB 6X4 NA 340			
				P 94 CB (4x2 * 6x2 * 6X4)			
				941 * 94H * 94U * P94 CB (6x4*4x2) * 114L * P114 * T114 CB (6x4*4x2) * 124E * R124 * K124 CA (6x4*6x2) * T124 * P124 CA * CB (6x4*4x2) * 164 * P230 * P270 * P310 * P340 * P420 * R380 * R420 * R480			
				R 124 GA 4X2 NA400			
				T 124 GA 6X4 * T 124 LA 6X4 NA400			
						VALTRA - VALMET	Tratores 1280 * 1284 * 1580 * 1780 * 1780 (4x4) * 1380 * 1680 * 1880 * 118 * 128 * 138 * 148 * 148 (4x4)
33019 F	TRB		MERCEDES BENZ	1113 (LPO * OH) * 1114 (LPO) * 1115 L (OH) * 1118 (LPO)	Eixo Traseiro / Eje Trasero / Rear Axle		
				1313 OH * 1314 OH * 1315 OH * 1316 (OH*OHL) * 1316 G (OH*OHL) * 1317 OH * 1318 OH * 1319 OH * 1320 (OH*OHL)			
				1418 OH * 1419 OH * 1420 (OH*OHL) * 1421 OHL			
				1517 OH * 1518 OH * 1519 OH * 1520 OH * 1521 OH			
				1721 L (OH)		Eixo Dianteiro / Eje Delantero / Front Axle	
				352 HL (O) (...74)		Eixo Traseiro / Eje Trasero / Rear Axle	
				355 O			
				362 O			
				364 O	Eixo Dianteiro / Eje Delantero / Front Axle		
				370 RS*RSD*RST* ST*U*UP (O) * 371 RS*RSD* RST* ST*U*UP (O)	Eixo Traseiro / Eje Trasero / Rear Axle		
				O 371 U * O 371 UL * O 371 UP			
				1113 (L*LA*LAK*LAS*LK*LP*LS*LP) * 1114 * 1114 (L*LK*LP) * 1116 (L*LA*LAK*LAS*LB*LK*LS) * 1118 (L*LK*LP)			
		1113 OF * 1115 OF					
		1214 C * 1214 K * 1214 (L*LK*LS) * 1215 * 1215 C * 1215 (L*LA*LK) * 1218 * 1218 R (L)					
		1215 OF * 1217 OF					
		1313 (L*LA*LAK*LB*LK*LS) * 1314 (L*LA*LAK*LB*LK*LS) * 1316 (L*LA*LAK*LAS*LB*LK*LS) * 1317 (L*LA*LAK*LK*LS) * 1319 (L)					
		1313 OF * 1314 OF * 1315 OF * 1316 OF * 1317 OF * 1318 OF * 1319 OF * 1320 OF					
		1414 * 1414 (K*L*LA*LAK*LK) * 1418 * 1418 (E*K*R) * 1418 (L*LA*LAK*LK*R(LK)) * 1419 (L*LK*LS) * 1420 (L*LK*LS)					
		1417 OF * 1419 OF * 1421 OF					
		1421 OMC					
		1513 (L*LA*LAK*LB*LG*LK*LS) * 1514 (L*LK*LS) * 1516 (L*LA*LAK*LB*LG*LK*LS) * 1517 (L*LK) * 1518 (L*LK*LS) * 1519 (L*LAK*LB*LG*LK*LS) * 1520 (L*LK*LP*LPK*LPS*LS) * 1521 L * 1524 e 1525 (L*LK*LS)					
		1517 OF * 1518 OF * 1520 OF					
		1614 * 1615 (L*LK*LS) * 1615 * 1618 M * 1618 (L*LK*LS) * 1619 (L)					
		1618 OF					
		1618 OF					
		1714 OF * 1721 OF * 1722 OF	Eixo Dianteiro / Eje Delantero / Front Axle				
			Eixo Traseiro / Eje Trasero / Rear Axle				









Fersa*			Brand / Marca / Marca	Model / Modelo / Modelo	Application / Aplicação / Aplicaciones
33019 F	TRB		MERCEDES BENZ	1714 * 1714 (L*K*LK) * 1715 * 1718 * 1718 (A * AK) * K * 1720 L * 1721 * 1721 S * 1721 (L*LK) * 1722 S * 1723 * 1723 S * 1725 L	Eixo Dianteiro / Eje Delantero / Front Axle Eixo Traseiro / Eje Trasero / Rear Axle
				1819 (L*LAK*LB*LG*LK*LS) * 1820 LG	Eixo Dianteiro / Eje Delantero / Front Axle
				1924 (LS) * 1924 A (LS) * 1929 (L*LK*LS) * 1930 (LS) * 1932 (LS) * 1933 (LS) * 1934 (LS) * 1935 (L*LS) * 1938 * 1938 S * 1938 (L*LS) * 1941 (L*LS) * 1944 S * 1945 (L*LS)	
				2013 (L*LA*LAK*LB*LG*LK*LS) * 2013 6X2 (L) * 2014 (L*LB*LK) * 2016 (LB*LK) * 2017 (L*LB*LK)	
				2213 (L*LB*LK*LS) * 2213 6X6 (LA) * 2214 * 2215 (L*LB*LK*LS) * 2216 (L*LA*LAK*LB*LG*LK*LS) * 2217 (L*LB*LK*LS) * 2219 (L*LA*LAK*LB*LG*LK*LS) * 2220 * 2222 * 2225 (L*LB*LK*LS)	
				2314 (L*LB*LK*LS) * 2318 (L*LB*LK*LS) * 2325 (L*LB*LK*LS)	
				2414 (6X4) * 2414 (L) * 2418 (L*LB*LK) * 2420 (L*LB*LK) * 2423 B 6X4 * 2423 K 6X4 * 2425 6X6 (LA) * 2425 (L*LB*LK) * 2428 6X4	Eixo Traseiro / Eje Trasero / Rear Axle
				1113 OF * 1115 OF	
				1215 OF * 1217 OF	
				1313 OF * 1314 OF * 1315 OF * 1316 OF * 1317 OF * 1318 OF * 1319 OF * 1320 OF	
				1417 OF * 1419 OF * 1421 OF	
				1421 OMC	
				1517 OF * 1518 OF * 1520 OF	
				1618 OF	
1714 OF * 1721 OF * 1722 OF	Eixo Dianteiro / Eje Delantero / Front Axle Eixo Traseiro / Eje Trasero / Rear Axle				
33020 F	TRB		MERCEDES BENZ	1313 OH * 1314 OH * 1315 OH * 1316 (OH*OHL) * 1316 G (OH*OHL) * 1317 OH * 1318 OH * 1319 OH * 1320 (OH*OHL)	
				1418 OH * 1419 OH * 1420 (OH*OHL) * 1421 OHL	
				1517 OH * 1518 OH * 1519 OH * 1520 OH * 1521 OH	
				1721 L (OH)	
				370 RS*RSD*RST* ST*U*UP (O) * 371 RS*RSD*RST* ST*U*UP (O)	
				400 (R * RS * RSD * RSL) (O)	
				500 (O*M* R)	
				Multego IBC 1842 * IBC 2242 * OC 500	
				O 371 R * O 371 RS * O 371 RSD	
				O 400 R * O 400 RS * O 400 RSD * O 400 RSE * O 400 RSL * MP 105 * MP 108 DD * MP120 * MP 180 DD	
				O500M 1728 * O500R 1735	
				1214 C * 1214 K * 1214 (L*LK*LS) * 1215 * 1215 C * 1215 (L*LA*LK) * 1218 * 1218 R (L)	
	1215 OF * 1217 OF				
	1313 (L*LA*LAK*LB*LK*LS) * 1314 (L*LA*LAK*LB*LK*LS) * 1316 (L*LA*LAK*LAS*LB*LK*LS) * 1317 (L*LA*LAK*LK*LS)* 1319 (L)	Eixo Traseiro / Eje Trasero / Rear Axle			
	1313 OF * 1314 OF * 1315 OF * 1316 OF * 1317 OF * 1318 OF * 1319 OF * 1320 OF				
	1414 * 1414 (K*L*LA*LAK*LK) * 1418 * 1418 (E*K*R) * 1418 (L*LA*LAK*LK*R(LK)) * 1419 (L*LK*LS) * 1420 (L*LK*LS)				
	1417 OF * 1419 OF * 1421 OF				
	1421 OMC				
	1513 (L*LA*LAK*LB*LG*LK*LS) * 1514 (L*LK*LS) * 1516 (L*LA*LAK*LB*LG*LK*LS) * 1517 (L*LK) * 1518 (L*LK*LS) * 1519 (L*LAK*LB*LG*LK*LS) * 1520 (L*LK*LP*LPK*LPS*LS) * 1521 L * 1524 e 1525 (L*LK*LS)				
	1517 OF * 1518 OF * 1520 OF				
	1614 * 1615 (L*LK*LS) * 1615 * 1618 M * 1618 (L*LK*LS) * 1619 (L)				
	1618 OF				
	1714 OF * 1721 OF * 1722 OF				
	1714 * 1714 (L*K*LK) * 1715 * 1718 * 1718 (A * AK) * K * 1720 L * 1721 * 1721 S * 1721 (L*LK) * 1722 S * 1723 * 1723 S * 1725 L				









Fersa®			Brand / Marca / Marca	Model / Modelo / Modelo	Application / Aplicação / Aplicaciones				
33020 F	TRB		MERCEDES BENZ	2013 (L*LA*LAK*LB*LG*LK*LS) * 2013 6X2 (L) * 2014 (L*LB*LK) * 2016 (LB*LK) * 2017 (L*LB*LK)	Eixo Traseiro / Eje Trasero / Rear Axle				
				2213 (L*LB*LK*LS) * 2213 6X6 (LA) * 2214 * 2215 (L*LB*LK*LS) * 2216 (L*LA*LAK*LB*LG*LK*LS) * 2217 (L*LB*LK*LS) * 2219 (L*LA*LAK*LB*LG*LK*LS) * 2220 * 2222 * 2225 (L*LB*LK*LS)					
				2314 (L*LB*LK*LS) * 2318 (L*LB*LK*LS) * 2325 (L*LB*LK*LS)					
				2414 (6X4) * 2414 (L) * 2418 (L*LB*LK) * 2420 (L*LB*LK) * 2423 B 6X4 * 2423 K 6X4 * 2425 6X6 (LA) * 2425 (L*LB*LK) * 2428 6X4					
				Axor 2625 * 2628 * 2629 (LK*LS) * 2631 (B*K*L) * 2632 * 2635 (B*K*L) * 2635 (L*LK*LS) * 2635 * 2638 (L*LK*LS) * Axor 2640 * 2641 * 2643 * Axor 2644 * Actos 2646 * 2648 * 2650 * 2651 * 2653 * 2654 (L*LK*LS) * 2657 * 2658 * 2644 * Atego 2628 (B*K) * 2625 * Axor 2826 * Axor 2828 * Axor 2831					
				2629 LS					
				2635 (L*LK*LS)					
				L1214 * L1215 * L1217 39 * L1217 52 * L1218 52					
				LK 1214 * LK 1215 * LK 1217 * LK 1218					
				OF 1215 * OF 1217					
				1215 OF * 1217 OF					
				1313 OF * 1314 OF * 1315 OF * 1316 OF * 1317 OF * 1318 OF * 1319 OF * 1320 OF					
	1417 OF * 1419 OF * 1421 OF								
	1421 OMC								
	1517 OF * 1518 OF * 1520 OF								
	1618 OF								
	1714 OF * 1721 OF * 1722 OF								
	OF 1215 * OF 1217								
33021 F	TRB		MERCEDES BENZ	1721 L (OH)	Eixo Traseiro / Eje Trasero / Rear Axle				
				370 RS*RSD*RST* ST*U*UP (O) * 371 RS*RSD* RST* ST*U*UP (O)					
				400 (R * RS * RSD * RSL) (O)					
				500 (O*M* R)					
				9700					
				1614 * 1615 (L*LK*LS) * 1615 * 1618 M * 1618 (L*LK*LS) * 1619 (L)					
		MERCEDES BENZ	1618 OF	1714 OF * 1721 OF * 1722 OF					
				1714 * 1714 (L*K*LK) * 1715 * 1718 * 1718 (A * AK) * K * 1720 L * 1721 * 1721 S * 1721 (L*LK) * 1722 S * 1723 * 1723 S * 1725 L					
				1618 OF					
				1714 OF * 1721 OF * 1722 OF					
				33022 F	TRB		MERCEDES BENZ	370 RS*RSD*RST* ST*U*UP (O) * 371 RS*RSD* RST* ST*U*UP (O)	Eixo Traseiro / Eje Trasero / Rear Axle
								1819 (L*LAK*LB*LG*LK*LS) * 1820 LG	
1924 (LS) * 1924 A (LS) * 1929 (L*LK*LS) * 1930 (LS) * 1932 (LS) * 1933 (LS) * 1934 (LS) * 1935 (L*LS) * 1938 * 1938 S * 1938 (L*LS) * 1941 (L*LS) * 1944 S * 1945 (L*LS)									
Axor 2625 * 2628 * 2629 (LK*LS) * 2631 (B*K*L) * 2632 * 2635 (B*K*L) * 2635 (L*LK*LS) * 2635 * 2638 (L*LK*LS) * Axor 2640 * 2641 * 2643 * Axor 2644 * Actos 2646 * 2648 * 2650 * 2651 * 2653 * 2654 (L*LK*LS) * 2657 * 2658 * 2644 * Atego 2628 (B*K) * 2625 * Axor 2826 * Axor 2828 * Axor 2831									
2629 LS									
2635 (L*LK*LS)									
3238 (6x4) K*S									
LS 1929 * LS 1930 * LS 1932 * LS 1933 * LS 1934 * LS 1935 * LS 1937 * LS 1938 * LS 1939 * LS 1941 * LS 1942 * LS 1944 * LS 1945 * LS 1951									
33109 F	TRB		MERCEDES BENZ	608 D * E (L*LO) * 708 D * E (L*LO) * 709 L * 710 L * 712 L	Eixo Dianteiro / Eje Delantero / Front Axle				
				O 817					
				608 (L*LO) * 708 (L*LO) * 809 (LO*OF) * 812 (LO*OF) * 814 LO * 817 O * 914 LO * 709 * 710 * 712 * 712 C * 811 * 911 L * 912 * 913 * 914 * 914 C * 917					
		MERCEDES BENZ	2414 (6X4) * 2414 (L) * 2418 (L*LB*LK) * 2420 (L*LB*LK) * 2423 B 6X4 * 2423 K 6X4 * 2425 6X6 (LA) * 2425 (L*LB*LK) * 2428 6X4	Caixa de Mudanças / Caja de Cambios / Gearbox					
				L 608 * L 708 * L 709 * L 710 * L 712 * L 714 * L 715 * L 718	Eixo Dianteiro / Eje Delantero / Front Axle				





Fersa®			Brand / Marca / Marca	Model / Modelo / Modelo	Application / Aplicação / Aplicaciones
33109 F	TRB		MERCEDES BENZ	L 911 * L 912 * L 913 * L 914	Eixo Dianteiro / Eje Delantero / Front Axle
				LO 709 * LO 710 * LO 712	
				LO 914	
		OF 1714 * OF 1718 * OF 1721 * OF 1725			
			MERCEDES BENZ	LO 709 * LO 710 * LO 712	
				LO 914	
OF 1714 * OF 1718 * OF 1721 * OF 1725					
33110 F	TRB		VOLVO	N * NL 10 BR * N * NL 12 BR * N 10BR Mark II * NL 10BR 6x2	Tomada de Força / Toma de Fuerza / Power Take-off
33111 F	TRB		MERCEDES BENZ	1113 (LPO*OH) * 1114 LPO * 1115 L (OH) * 1118 LPO	Eixo Traseiro / Eje Trasero / Rear Axle
				608 D * E (L*LO) * 708 D * E (L*LO) * 709 L * 710 L * 712 L	Eixo Dianteiro / Eje Delantero / Front Axle
				812 LO * 912 L	
				O 817	
		608 (L*LO) * 708 (L*LO) * 809 (LO*OF) * 812 (LO*OF) * 814 LO * 817 O * 914 LO * 709 * 710 * 712 * 712 C * 811 * 911 L * 912 * 913 * 914 * 914 C * 917			
			MERCEDES BENZ	1113 (L*LA*LAK*LAS*LK*LP*LS*LP) * 1114 * 1114 (L*LK*LP) * 1116 (L*LA*LAK*LAS*LB* LK*LS) * 1118 (L*LK*LP)	Eixo Traseiro / Eje Trasero / Rear Axle
				1113 OF * 1115 OF	Eixo Dianteiro / Eje Delantero / Front Axle
				1113 OF * 1115 OF	Eixo Traseiro / Eje Trasero / Rear Axle
				1819 (L*LAK*LB*LG*LK*LS) * 1820 LG	Eixo Dianteiro / Eje Delantero / Front Axle
				L 608 * L 708 * L 709 * L 710 * L 712 * L 714 * L 715 * L 718	Eixo Traseiro / Eje Trasero / Rear Axle
				L 911 * L 912 * L 913 * L 914	
				LO 608 * LO 708	
				LO 709 * LO 710 * LO 712	
				LO 914	
				LO 914	
			MERCEDES BENZ	1113 OF * 1115 OF	Eixo Dianteiro e Traseiro / Eje Delantero y Trasero / Front and Rear Axle
				LO 709 * LO 710 * LO 712	
		33112 F	TRB		MERCEDES BENZ
	MERCEDES BENZ				
				1313 OF * 1314 OF * 1315 OF * 1316 OF * 1317 OF * 1318 OF * 1319 OF * 1320 OF	
				1819 (L*LAK*LB*LG*LK*LS) * 1820 LG	
				2213 (L*LB*LK*LS) * 2213 6X6 (LA) * 2214 * 2215 (L*LB*LK*LS) * 2216 (L*LA*LAK*LB*LG*LK*LS) * 2217 (L*LB*LK*LS) * 2219 (L*LA*LAK*LB*LG*LK*LS) * 2220 * 2222 * 2225 (L*LB*LK*LS)	
				2314 (L*LB*LK*LS) * 2318 (L*LB*LK*LS) * 2325 (L*LB*LK*LS)	
				1313 OF * 1314 OF * 1315 OF * 1316 OF * 1317 OF * 1318 OF * 1319 OF * 1320 OF	
				1313 OF * 1314 OF * 1315 OF * 1316 OF * 1317 OF * 1318 OF * 1320 (OH*OHL)	
				1313 (L*LA*LAK*LB*LK*LS) * 1314 (L*LA*LAK*LB*LK*LS) * 1316 (L*LA*LAK*LAS*LB*LK*LS) * 1317 (L*LA*LAK*LK*LS)* 1319 (L)	
1313 OF * 1314 OF * 1315 OF * 1316 OF * 1317 OF * 1318 OF * 1319 OF * 1320 OF					
1819 (L*LAK*LB*LG*LK*LS) * 1820 LG					
33113 F	TRB		MERCEDES BENZ	1313 OH * 1314 OH * 1315 OH * 1316 (OH*OHL) * 1316 G (OH*OHL) * 1317 OH * 1318 OH * 1319 OH * 1320 (OH*OHL)	Caixa de Mudanças / Caja de Cambios / Gearbox
					
		1313 OF * 1314 OF * 1315 OF * 1316 OF * 1317 OF * 1318 OF * 1319 OF * 1320 OF			
		1819 (L*LAK*LB*LG*LK*LS) * 1820 LG			
		2213 (L*LB*LK*LS) * 2213 6X6 (LA) * 2214 * 2215 (L*LB*LK*LS) * 2216 (L*LA*LAK*LB*LG*LK*LS) * 2217 (L*LB*LK*LS) * 2219 (L*LA*LAK*LB*LG*LK*LS) * 2220 * 2222 * 2225 (L*LB*LK*LS)			
		2314 (L*LB*LK*LS) * 2318 (L*LB*LK*LS) * 2325 (L*LB*LK*LS)			
		2414 (6X4) * 2414 (L) * 2418 (L*LB*LK) * 2420 (L*LB*LK) * 2423 B 6X4 * 2423 K 6X4 * 2425 6X6 (LA) * 2425 (L*LB*LK) * 2428 6X4			
		1313 OF * 1314 OF * 1315 OF * 1316 OF * 1317 OF * 1318 OF * 1319 OF * 1320 OF			
		1313 OF * 1314 OF * 1315 OF * 1316 OF * 1317 OF * 1318 OF * 1320 OF			







Fersa®			Brand / Marca / Marca	Model / Modelo / Modelo	Application / Aplicação / Aplicaciones
33114 F	TRB		MERCEDES BENZ	2013 (L*LA*LAK*LB*LG*LK*LS) * 2013 6X2 (L) * 2014 (L*LB*LK) * 2016 (LB*LK) * 2017 (L*LB*LK) 2213 (L*LB*LK*LS) * 2213 6X6 (LA) * 2214 * 2215 (L*LB*LK*LS) * 2216 (L*LA*LAK*LB*LG*LK*LS) * 2217 (L*LB*LK*LS) * 2219 (L*LA*LAK*LB*LG*LK*LS) * 2220 * 2222 * 2225 (L*LB*LK*LS) 2314 (L*LB*LK*LS) * 2318 (L*LB*LK*LS) * 2325 (L*LB*LK*LS) 2414 (6X4) * 2414 (L) * 2418 (L*LB*LK) * 2420 (L*LB*LK) * 2423 B 6X4 * 2423 K 6X4 * 2425 6X6 (LA) * 2425 (L*LB*LK) * 2428 6X4	Eixo Traseiro / Eje Trasero / Rear Axle
33115 F	TRB		MERCEDES BENZ	1621 L (OH) * 1623 LG (OH) * 1625 (OH) * 1625 L (OH) * 1628 L (OH) * 1630L (OH) * 1635 (OH) * 1636 L (OH) 1721 L (OH) 370 RS*RSD*RST* ST*U*UP (O) * 371 RS*RSD*RST* ST*U*UP (O) 1614 * 1615 (L*LK*LS) * 1615 * 1618 M * 1618 (L*LK*LS) * 1619 (L) 1618 OF 1620(L*LK*LS) * 1620 6X2 51 (L) * 1621 (L*LK*LS) * 1622(L*LK*LS) * 1623 (L*LS) * 1625(L*LK*LS) * 1630 (L*LK*LS) * 1632 (L*LS) * 1633(L*LK*LS) * 1634 (L*LS) * 1635 L 1620 OF * 1621 OF 1714 OF * 1721 OF * 1722 OF 1714 * 1714 (L*K*LK) * 1715 * 1718 * 1718 (A * AK) * K * 1720 L * 1721 * 1721 S * 1721 (L*LK) * 1722 S * 1723 * 1723 S * 1725 L 1924 (LS) * 1924 A (LS) * 1929 (L*LK*LS) * 1930 (LS) * 1932 (LS) * 1933 (LS) * 1934 (LS) * 1935 (L*LS) * 1938 * 1938 S * 1938 (L*LS) * 1941 (L*LS) * 1944 S * 1945 (L*LS) Axor 2625 * 2628 * 2629 (LK*LS) * 2631 (B*K*L) * 2632 * 2635 (B*K*L) * 2635 (L*LK*LS) * 2635 * 2638 (L*LK*LS) * Axor 2640 * 2641 * 2643 * Axor 2644 * Actos 2646 * 2648 * 2650 * 2651 * 2653 * 2654 (L*LK*LS) * 2657 * 2658 * 2644 * Atego 2628 (B*K) * 2625 * Axor 2826 * Axor 2828 * Axor 2831 2629 LS 2635 (L*LK*LS) 2635 (L*LK*LS) L1618 L1621 54 * L1621 59 * L1621 60 * L1621 70 * L1622 * L1623 * L1625 L 1524 * L 1525 L 1620 LK 1614 * LK 1615 * LK 1617 * LK 1618 * LK 1620 * LK 1621 * LK 1622 * LK 1623 * LK 1625 * LK 1630 * LK 1633 * LK 1634	Eixo Traseiro / Eje Trasero / Rear Axle
33116 F	TRB		MERCEDES BENZ	1418 OH * 1419 OH * 1420 (OH*OHL) * 1421 OHL 1721 L (OH) 400 (R * RS * RSD * RSL) (O) 500 (O*M* R) O500M 1728 * O500R 1735 1414 * 1414 (K*L*LA*LAK*LK) * 1418 * 1418 (E*K*R) * 1418 (L*LA*LAK*LK*R(LK)) * 1419 (L*LK*LS) * 1420 (L*LK*LS) 1417 OF * 1419 OF * 1421 OF 1421 OMC 1614 * 1615 (L*LK*LS) * 1615 * 1618 M * 1618 (L*LK*LS) * 1619 (L) 1618 OF 1714 OF * 1721 OF * 1722 OF 1714 * 1714 (L*K*LK) * 1715 * 1718 * 1718 (A * AK) * K * 1720 L * 1721 * 1721 S * 1721 (L*LK) * 1722 S * 1723 * 1723 S * 1725 L 1924 (LS) * 1924 A (LS) * 1929 (L*LK*LS) * 1930 (LS) * 1932 (LS) * 1933 (LS) * 1934 (LS) * 1935 (L*LS) * 1938 * 1938 S * 1938 (L*LS) * 1941 (L*LS) * 1944 S * 1945 (L*LS) 2013 (L*LA*LAK*LB*LG*LK*LS) * 2013 6X2 (L) * 2014 (L*LB*LK) * 2016 (LB*LK) * 2017 (L*LB*LK) 2414 (6X4) * 2414 (L) * 2418 (L*LB*LK) * 2420 (L*LB*LK) * 2423 B 6X4 * 2423 K 6X4 * 2425 6X6 (LA) * 2425 (L*LB*LK) * 2428 6X4 1417 OF * 1419 OF * 1421 OF 1421 OMC 1618 OF 1714 OF * 1721 OF * 1722 OF	Eixo Traseiro / Eje Trasero / Rear Axle







Fersa*			Brand / Marca / Marca	Model / Modelo / Modelo	Application / Aplicação / Aplicaciones
33117 F	TRB		MERCEDES BENZ	1313 OH * 1314 OH * 1315 OH * 1316 (OH*OHL) * 1316 G (OH*OHL) * 1317 OH * 1318 OH * 1319 OH * 1320 (OH*OHL) 1418 OH * 1419 OH * 1420 (OH*OHL) * 1421 OHL 1418 OH * 1419 OH * 1420 (OH*OHL) * 1421 OHL 1517 OH * 1518 OH * 1519 OH * 1520 OH * 1521 OH 1721 L (OH) 370 RS*RSD*RST* ST*U*UP (O) * 371 RS*RSD*RST* ST*U*UP (O) 400 (R * RS * RSD * RSL) (O) 500 (O*M* R) Multego IBC 1842 * IBC 2242 * OC 500 O 371 R * O 371 RS * O 371 RSD O 400 R * O 400 RS * O 400 RSD * O 400 RSE * O 400 RSL * MP 105 * MP 108 DD * MP120 * MP 180 DD O 371 U * O 371 UL * O 371 UP	Eixo Traseiro / Eje Trasero / Rear Axle
			MERCEDES BENZ	1214 C * 1214 K * 1214 (L*LK*LS) * 1215 * 1215 C * 1215 (L*LA*LK) * 1218 * 1218 R (L) 1215 OF * 1217 OF 1313 (L*LA*LAK*LB*LK*LS) * 1314 (L*LA*LAK*LB*LK*LS) * 1316 (L*LA*LAK*LAS*LB*LK*LS) * 1317 (L*LA*LAK*LB*LK*LS)* 1319 (L) 1313 OF * 1314 OF * 1315 OF * 1316 OF * 1317 OF * 1318 OF * 1319 OF * 1320 OF 1414 * 1414 (K*L*LA*LAK*LK) * 1418 * 1418 (E*K*R) * 1418 (L*LA*LAK*LK*R(LK)) * 1419 (L*LK*LS) * 1420 (L*LK*LS) 1417 OF * 1419 OF * 1421 OF 1421 OMC 1513 (L*LA*LAK*LB*LG*LK*LS) * 1514 (L*LK*LS) * 1516 (L*LA*LAK*LB*LG*LK*LS) * 1517 (L*LK) * 1518 (L*LK*LS) * 1519 (L*LAK*LB*LG*LK*LS) * 1520 (L*LK*LP*LPK*LPS*LS) * 1521 L * 1524 e 1525 (L*LK*LS) 1517 OF * 1518 OF * 1520 OF 1614 * 1615 (L*LK*LS) * 1615 * 1618 M * 1618 (L*LK*LS) * 1619 (L) 1618 OF 1714 OF * 1721 OF * 1722 OF 1714 * 1714 (L*K*LK) * 1715 * 1718 * 1718 (A * AK) * K * 1720 L * 1721 * 1721 S * 1721 (L*LK) * 1722 S * 1723 * 1723 S * 1725 L 2213 (L*LB*LK*LS) * 2213 6X6 (LA) * 2214 * 2215 (L*LB*LK*LS) * 2216 (L*LA*LAK*LB*LG*LK*LS) * 2217 (L*LB*LK*LS) * 2219 (L*LA*LAK*LB*LG*LK*LS) * 2220 * 2222 * 2225 (L*LB*LK*LS) 2314 (L*LB*LK*LS) * 2318 (L*LB*LK*LS) * 2325 (L*LB*LK*LS) 2414 (6X4) * 2414 (L) * 2418 (L*LB*LK) * 2420 (L*LB*LK) * 2423 B 6X4 * 2423 K 6X4 * 2425 6X6 (LA) * 2425 (L*LB*LK) * 2428 6X4 Axor 2625 * 2628 * 2629 (LK*LS) * 2631 (B*K*L) * 2632 * 2635 (B*K*L) * 2635 (L*LK*LS) * 2635 * 2638 (L*LK*LS) * Axor 2640 * 2641 * 2643 * Axor 2644 * Actos 2646 * 2648 * 2650 * 2651 * 2653 * 2654 (L*LK*LS) * 2657 * 2658 * 2644 * Atego 2628 (B*K) * 2625 * Axor 2826 * Axor 2828 * Axor 2831 2629 LS 2635 (L*LK*LS)	
			MERCEDES BENZ	1215 OF * 1217 OF 1313 OF * 1314 OF * 1315 OF * 1316 OF * 1317 OF * 1318 OF * 1319 OF * 1320 OF 1417 OF * 1419 OF * 1421 OF 1421 OMC 1517 OF * 1518 OF * 1520 OF 1618 OF 1714 OF * 1721 OF * 1722 OF	
33205 F	TRB		MERCEDES BENZ	608 D * E (L*LO) * 708 D * E (L*LO) * 709 L * 710 L * 712 L O 817	Eixo Dianteiro / Eje Delantero / Front Axle
			MERCEDES BENZ	608 (L*LO) * 708 (L*LO) * 809 (LO*OF) * 812 (LO*OF) * 814 LO * 817 O * 914 LO * 709 * 710 * 712 * 712 C * 811 * 911 L * 912 * 913 * 914 * 914 C * 917 L 608 * L 708 * L 709 * L 710 * L 712 * L 714 * L 715 * L 718 L 911 * L 912 * L 913 * L 914 LO 709 * LO 710 * LO 712	

















Fersa®			Brand / Marca / Marca	Model / Modelo / Modelo	Application / Aplicação / Aplicaciones		
33205 F	TRB		MERCEDES BENZ	LO 914 OF 1714 * OF 1718 * OF 1721 * OF 1725	Eixo Dianteiro / Eje Delantero / Front Axle		
			MERCEDES BENZ	LO 709 * LO 710 * LO 712 LO 914 OF 1714 * OF 1718 * OF 1721 * OF 1725			
			CBT	2070 * 2080 * 2100 * 2105 (4x2) * 2400 * 2400 (4x4) * 2500 * 2600 Tratores 1000 * 1000 (4x4) * 1020 * 1020 (4x4) * 1065 * 1065 (4x4) * 1090 * 1105	Câmbio / Caja de Cambios / Gearbox		
			MERCEDES BENZ	Sprinter 313 * 413 Sprinter 315 Sprinter 316 Sprinter 415 Sprinter 416 Sprinter 515	Eixo Dianteiro / Eje Delantero / Front Axle		
		33207 F	TRB		MERCEDES BENZ	915 (LO) * 915 C	Eixo Dianteiro / Eje Delantero / Front Axle
	MERCEDES BENZ			2013 (L*LA*LAK*LB*LG*LK*LS) * 2013 6X2 (L) * 2014 (L*LB*LK) * 2016 (LB*LK) * 2017 (L*LB*LK) 615 (LO) * 715 C			
33208 F	TRB		MERCEDES BENZ	1113 (LPO*OH) * 1114 LPO * 1115 L (OH) * 1118 LPO 1313 OH * 1314 OH * 1315 OH * 1316 (OH*OHL) * 1316 G (OH*OHL) * 1317 OH * 1318 OH * 1319 OH * 1320 (OH*OHL) 1418 OH * 1419 OH * 1420 (OH*OHL) * 1421 OHL 1517 OH * 1518 OH * 1519 OH * 1520 OH * 1521 OH 1721 L (OH)	Eixo Dianteiro / Eje Delantero / Front Axle		
				SCANIA	115 * 116 BR 140 (LK*LKS) K 113 P 93 * R 113 * R 143 * T 113	Caixa de Mudanças / Caja de Cambios / Gearbox	
					GENERAL MOTORS	6-100 (4X2)* 6-150* 12-170 L*S (4X2)* 14-190 (77...) (4X2)* 15-190 (77...) (4X2)* 16-220 (4X2) Kodiak	Eixo Dianteiro / Eje Delantero / Front Axle
						MERCEDES BENZ	













Fersa®			Brand / Marca / Marca	Model / Modelo / Modelo	Application / Aplicação / Aplicaciones		
33208 F	TRB		SCANIA	112 (F*K*S)	Caixa de Mudanças / Caja de Cambios / Gearbox		
				F 113 * L 113 * K 113			
				P 114 GA (4X2) * R 114 GA (4X2 * 6X4) * T 114 GA (4X2) * T 114 LA (6X2)			
				R 112 (81...)			
				R 142 MA (4X2)(81...)			
				T 142 E (6X4)			
				VOLVO	N * NL 10 BR * N * NL 12 BR * N 10BR Mark II * NL 10BR 6x2	Eixo Dianteiro / Eje Delantero / Front Axle	
			MERCEDES BENZ	1113 OF * 1115 OF			
				1215 OF * 1217 OF			
				1313 OF * 1314 OF * 1315 OF * 1316 OF * 1317 OF * 1318 OF * 1319 OF * 1320 OF			
				1417 OF * 1419 OF * 1421 OF			
				1421 OMC			
				1517 OF * 1518 OF * 1520 OF			
				1618 OF			
1714 OF * 1721 OF * 1722 OF							
33209 F	TRB		MERCEDES BENZ	1313 OH * 1314 OH * 1315 OH * 1316 (OH*OHL) * 1316 G (OH*OHL) * 1317 OH * 1318 OH * 1319 OH * 1320 (OH*OHL)	Caixa de Mudanças / Caja de Cambios / Gearbox Eixo Dianteiro / Eje Delantero / Front Axle		
					MERCEDES BENZ	1313 (L*LA*LAK*LB*LK*LS) * 1314 (L*LA*LAK*LB*LK*LS) * 1316 (L*LA*LAK*LAS*LB*LK*LS) * 1317 (L*LA*LAK*LK*LS)* 1319 (L)	Caixa de Mudanças / Caja de Cambios / Gearbox Eixo Dianteiro / Eje Delantero / Front Axle
						1313 OF * 1314 OF * 1315 OF * 1316 OF * 1317 OF * 1318 OF * 1319 OF * 1320 OF	Caixa de Mudanças / Caja de Cambios / Gearbox Eixo Dianteiro / Eje Delantero / Front Axle
		1819 (L*LAK*LB*LG*LK*LS) * 1820 LG	Caixa de Mudanças / Caja de Cambios / Gearbox				
		2213 (L*LB*LK*LS) * 2213 6X6 (LA) * 2214 * 2215 (L*LB*LK*LS) * 2216 (L*LA*LAK*LB*LG*LK*LS) * 2217 (L*LB*LK*LS) * 2219 (L*LA*LAK*LB*LG*LK*LS) * 2220 * 2222 * 2225 (L*LB*LK*LS)					
		2314 (L*LB*LK*LS) * 2318 (L*LB*LK*LS) * 2325 (L*LB*LK*LS)					
		2414 (6X4) * 2414 (L) * 2418 (L*LB*LK) * 2420 (L*LB*LK) * 2423 B 6X4 * 2423 K 6X4 * 2425 6X6 (LA) * 2425 (L*LB*LK) * 2428 6X4					
						MERCEDES BENZ	1313 OF * 1314 OF * 1315 OF * 1316 OF * 1317 OF * 1318 OF * 1319 OF * 1320 OF
		33210 F	TRB		MERCEDES BENZ	1313 OH * 1314 OH * 1315 OH * 1316 (OH*OHL) * 1316 G (OH*OHL) * 1317 OH * 1318 OH * 1319 OH * 1320 (OH*OHL)	Caixa de Mudanças / Caja de Cambios / Gearbox
						1418 OH * 1419 OH * 1420 (OH*OHL) * 1421 OHL	Eixo Dianteiro / Eje Delantero / Front Axle
						1721 L (OH)	Caixa de Transferência / Caja de Transferencia / Transfer Case
						OH 1625 L * OH1630 L * OH 1635 L * OH 1636 L	
					MERCEDES BENZ	1214 C * 1214 K * 1214 (L*LK*LS) * 1215 * 1215 C * 1215 (L*LA*LK) * 1218 * 1218 R (L)	Caixa de Mudanças / Caja de Cambios / Gearbox
1215 OF * 1217 OF							
1313 (L*LA*LAK*LB*LK*LS) * 1314 (L*LA*LAK*LB*LK*LS) * 1316 (L*LA*LAK*LAS*LB*LK*LS) * 1317 (L*LA*LAK*LK*LS)* 1319 (L)							
1313 OF * 1314 OF * 1315 OF * 1316 OF * 1317 OF * 1318 OF * 1319 OF * 1320 OF	Eixo Dianteiro / Eje Delantero / Front Axle						
1414 * 1414 (K*L*LA*LAK*LK) * 1418 * 1418 (E*K*R) * 1418 (L*LA*LAK*LK*R(LK)) * 1419 (L*LK*LS) * 1420 (L*LK*LS)							
1417 OF * 1419 OF * 1421 OF							
1421 OMC							
1614 * 1615 (L*LK*LS) * 1615 * 1618 M * 1618 (L*LK*LS) * 1619 (L)							
1618 OF							
1714 OF * 1721 OF * 1722 OF							
1714 * 1714 (L*K*LK) * 1715 * 1718 * 1718 (A * AK) * K * 1720 L * 1721 * 1721 S * 1721 (L*K) * 1722 S * 1723 * 1723 S * 1725 L							





Fersa*			Brand / Marca / Marca	Model / Modelo / Modelo	Application / Aplicação / Aplicaciones	
33212 F	TRB		MERCEDES BENZ	1313 (L*LA*LAK*LB*LK*LS) * 1314 (L*LA*LAK*LB*LK*LS) * 1316 (L*LA*LAK*LAS*LB*LK*LS) * 1317 (L*LA*LAK*LK*LS)* 1319 (L)	Caixa de Mudanças / Caja de Cambios / Gearbox	
				1313 OF * 1314 OF * 1315 OF * 1316 OF * 1317 OF * 1318 OF * 1319 OF * 1320 OF		
				1819 (L*LAK*LB*LG*LK*LS) * 1820 LG		
				2213 (L*LB*LK*LS) * 2213 6X6 (LA) * 2214 * 2215 (L*LB*LK*LS) * 2216 (L*LA*LAK*LB*LG*LK*LS) * 2217 (L*LB*LK*LS) * 2219 (L*LA*LAK*LB*LG*LK*LS) * 2220 * 2222 * 2225 (L*LB*LK*LS)		
				2314 (L*LB*LK*LS) * 2318 (L*LB*LK*LS) * 2325 (L*LB*LK*LS)		
				2414 (6X4) * 2414 (L) * 2418 (L*LB*LK) * 2420 (L*LB*LK) * 2423 B 6X4 * 2423 K 6X4 * 2425 6X6 (LA) * 2425 (L*LB*LK) * 2428 6X4		
				P 114 * R 124 * T 114 CB 6x4 * 4x2 * T 124		
				P 94 CB (4x2 * 6x2 * 6X4)		
				94I * 94H * 94U * P94 CB (6x4*4x2) * 114L * P114 * T114 CB (6x4*4x2) * 124E * R124 * K124 CA (6x4*6x2) * T124 * P124 CA * CB (6x4*4x2) * 164 * P230 * P270 * P310 * P340 * P420 * R380 * R420 * R480		Eixo Traseiro / Eje Trasero / Rear Axle
				VOLVO		
			MERCEDES BENZ	1313 OF * 1314 OF * 1315 OF * 1316 OF * 1317 OF * 1318 OF * 1319 OF * 1320 OF	Caixa de Mudanças / Caja de Cambios / Gearbox	
33213 F	TRB		MERCEDES BENZ	1113 (LPO*OH) * 1114 LPO * 1115 L (OH) * 1118 LPO	Eixo Dianteiro / Eje Delantero / Front Axle	
				1313 OH * 1314 OH * 1315 OH * 1316 (OH*OHL) * 1316 G (OH*OHL) * 1317 OH * 1318 OH * 1319 OH * 1320 (OH*OHL)		
				1418 OH * 1419 OH * 1420 (OH*OHL) * 1421 OHL		
				1517 OH * 1518 OH * 1519 OH * 1520 OH * 1521 OH		
				1721 L (OH)		
				1113 (L*LA*LAK*LAS*LK*LP*LS*LP) * 1114 * 1114 (L*LK*LP) * 1116 (L*LA*LAK*LAS*LB* LK*LS) * 1118 (L*LK*LP)		
				1113 OF * 1115 OF		
				1214 C * 1214 K * 1214 (L*LK*LS) * 1215 * 1215 C * 1215 (L*LA*LK) * 1218 * 1218 R (L)		
				1215 OF * 1217 OF		
				1313 (L*LA*LAK*LB*LK*LS) * 1314 (L*LA*LAK*LB*LK*LS) * 1316 (L*LA*LAK*LAS*LB*LK*LS) * 1317 (L*LA*LAK*LK*LS)* 1319 (L)		
				1313 OF * 1314 OF * 1315 OF * 1316 OF * 1317 OF * 1318 OF * 1319 OF * 1320 OF		
				1414 * 1414 (K*L*LA*LAK*LK) * 1418 * 1418 (E*K*R) * 1418 (L*LA*LAK*LK*R(LK)) * 1419 (L*LK*LS) * 1420 (L*LK*LS)		
				1417 OF * 1419 OF * 1421 OF		
				1421 OMC		
				1513 (L*LA*LAK*LB*LG*LK*LS) * 1514 (L*LK*LS) * 1516 (L*LA*LAK*LB*LG*LK*LS) * 1517 (L*LK) * 1518 (L*LK*LS) * 1519 (L*LAK*LB*LG*LK*LS) * 1520 (L*LK*LP*LPK*LPS*LS) * 1521 L * 1524 e 1525 (L*LK*LS)		
		1517 OF * 1518 OF * 1520 OF				
		1614 * 1615 (L*LK*LS) * 1615 * 1618 M * 1618 (L*LK*LS) * 1619 (L)				
		1618 OF				
		1714 OF * 1721 OF * 1722 OF				
		1714 * 1714 (L*K*LK) * 1715 * 1718 * 1718 (A * AK) * K * 1720 L * 1721 * 1721 S * 1721 (L*LK) * 1722 S * 1723 * 1723 S * 1725 L				
		2013 (L*LA*LAK*LB*LG*LK*LS) * 2013 6X2 (L) * 2014 (L*LB*LK) * 2016 (LB*LK) * 2017 (L*LB*LK)				
		2213 (L*LB*LK*LS) * 2213 6X6 (LA) * 2214 * 2215 (L*LB*LK*LS) * 2216 (L*LA*LAK*LB*LG*LK*LS) * 2217 (L*LB*LK*LS) * 2219 (L*LA*LAK*LB*LG*LK*LS) * 2220 * 2222 * 2225 (L*LB*LK*LS)				
		2314 (L*LB*LK*LS) * 2318 (L*LB*LK*LS) * 2325 (L*LB*LK*LS)				
		2414 (6X4) * 2414 (L) * 2418 (L*LB*LK) * 2420 (L*LB*LK) * 2423 B 6X4 * 2423 K 6X4 * 2425 6X6 (LA) * 2425 (L*LB*LK) * 2428 6X4				
		L 1714 * L 1715 * L 1718 * L 1720 * L 1721 * L 1722 * L 1723 * L 1724 * L 1728				
		LK 1714 * LK 1715 * LK 1718 * LK 1720 * LK 1721 * LK 1722 * LK 1723 * LK 1724 * LK 1728				
		OF 1714 * OF 1718 * OF 1721 * OF 1725				



Fersa®			Brand / Marca / Marca	Model / Modelo / Modelo	Application / Aplicação / Aplicaciones		
33213 F	TRB		MERCEDES BENZ	1113 OF * 1115 OF	Eixo Dianteiro / Eje Delantero / Front Axle		
				1215 OF * 1217 OF			
				1313 OF * 1314 OF * 1315 OF * 1316 OF * 1317 OF * 1318 OF * 1319 OF * 1320 OF			
				1417 OF * 1419 OF * 1421 OF			
				1421 OMC			
				1517 OF * 1518 OF * 1520 OF			
				1618 OF			
				1714 OF * 1721 OF * 1722 OF			
				OF 1714 * OF 1718 * OF 1721 * OF 1725			
				OF 1714 * OF 1718 * OF 1721 * OF 1725			
33214 F			MERCEDES BENZ	1313 OH * 1314 OH * 1315 OH * 1316 (OH*OHL) * 1316 G (OH*OHL) * 1317 OH * 1318 OH * 1319 OH * 1320 (OH*OHL)	Eixo Dianteiro / Eje Delantero / Front Axle		
				1418 OH * 1419 OH * 1420 (OH*OHL) * 1421 OHL			
				1721 L (OH)			
				OH 1113			
				1313 (L*LA*LAK*LB*LK*LS) * 1314 (L*LA*LAK*LB*LK*LS) * 1316 (L*LA*LAK*LAS*LB*LK*LS) * 1317 (L*LA*LAK*LB*LS)* 1319 (L)			
				1313 OF * 1314 OF * 1315 OF * 1316 OF * 1317 OF * 1318 OF * 1319 OF * 1320 OF			
				1414 * 1414 (K*L*LA*LAK*LK) * 1418 * 1418 (E*K*R) * 1418 (L*LA*LAK*LK*R(LK)) * 1419 (L*LK*LS) * 1420 (L*LK*LS)			
				1417 OF * 1419 OF * 1421 OF			
				1421 OMC			
				1614 * 1615 (L*LK*LS) * 1615 * 1618 M * 1618 (L*LK*LS) * 1619 (L)			
				1618 OF			
				1714 OF * 1721 OF * 1722 OF			
				1714 * 1714 (L*K*LK) * 1715 * 1718 * 1718 (A * AK) * K * 1720 L * 1721 * 1721 S * 1721 (L*LK) * 1722 S * 1723 * 1723 S * 1725 L			
				1819 (L*LAK*LB*LG*LK*LS) * 1820 LG			
	1924 (LS) * 1924 A (LS) * 1929 (L*LK*LS) * 1930 (LS) * 1932 (LS) * 1933 (LS) * 1934 (LS) * 1935 (L*LS) * 1938 * 1938 S * 1938 (L*LS) * 1941 (L*LS) * 1944 S * 1945 (L*LS)	Eixo Traseiro / Eje Trasero / Rear Axle					
	2414 (6X4) * 2414 (L) * 2418 (L*LB*LK) * 2420 (L*LB*LK) * 2423 B 6X4 * 2423 K 6X4 * 2425 6X6 (LA) * 2425 (L*LB*LK) * 2428 6X4	Eixo Dianteiro / Eje Delantero / Front Axle					
	LK 1313 * LK 1314 * LK 1315 * LK 1316 * LK 1317 * LK 1318 * LK 1319 * LK 1320 * LK 1321						
	LS 1314 * LS 1315 * LS 1316 * LS 1317 * LS 1318 * LS 1319						
	1313 OF * 1314 OF * 1315 OF * 1316 OF * 1317 OF * 1318 OF * 1319 OF * 1320 OF						
	1417 OF * 1419 OF * 1421 OF						
	1421 OMC						
	1618 OF						
	1714 OF * 1721 OF * 1722 OF						
	33215 F				MERCEDES BENZ	1113 (LPO*OH) * 1114 LPO * 1115 L (OH) * 1118 LPO	Eixo Traseiro / Eje Trasero / Rear Axle
						1313 OH * 1314 OH * 1315 OH * 1316 (OH*OHL) * 1316 G (OH*OHL) * 1317 OH * 1318 OH * 1319 OH * 1320 (OH*OHL)	
		1418 OH * 1419 OH * 1420 (OH*OHL) * 1421 OHL					
		1517 OH * 1518 OH * 1519 OH * 1520 OH * 1521 OH					
		1721 L (OH)					
352 HL (O) (...74)							
355 O							
362 O							
364 O							
364 O							
370 RS*RSD*RST* ST*U*UP (O) * 371 RS*RSD*RST* ST*U*UP (O)							
O 371 U * O 371 UL * O 371 UP							
			MERCEDES BENZ	1113 (L*LA*LAK*LAS*LK*LP*LS*LP) * 1114 * 1114 (L*LK*LP) * 1116 (L*LA*LAK*LAS*LB*LK*LS) * 1118 (L*LK*LP)			
				1113 OF * 1115 OF			
	1214 C * 1214 K * 1214 (L*LK*LS) * 1215 * 1215 C * 1215 (L*LA*LK) * 1218 * 1218 R (L)						



Fersa*			Brand / Marca / Marca	Model / Modelo / Modelo	Application / Aplicação / Aplicaciones											
33215 F	TRB		MERCEDES BENZ	1215 OF * 1217 OF	Eixo Traseiro / Eje Trasero / Rear Axle											
				1313 (L*LA*LAK*LB*LK*LS) * 1314 (L*LA*LAK*LB*LK*LS) * 1316 (L*LA*LAK*LAS*LB*LK*LS) * 1317 (L*LA*LAK*LK*LS) * 1319 (L) 1313 OF * 1314 OF * 1315 OF * 1316 OF * 1317 OF * 1318 OF * 1319 OF * 1320 OF												
				1414 * 1414 (K*LA*LAK*LK) * 1418 * 1418 (E*K*R) * 1418 (L*LA*LAK*LK*R(LK)) * 1419 (L*LK*LS) * 1420 (L*LK*LS)												
				1417 OF * 1419 OF * 1421 OF												
				1421 OMC												
				1513 (L*LA*LAK*LB*LG*LK*LS) * 1514 (L*LK*LS) * 1516 (L*LA*LAK*LB*LG*LK*LS) * 1517 (L*LK) * 1518 (L*LK*LS) * 1519 (L*LAK*LB*LG*LK*LS) * 1520 (L*LK*LP*LPK*LPS*LS) * 1521 L * 1524 e 1525 (L*LK*LS)												
				1517 OF * 1518 OF * 1520 OF												
				1614 * 1615 (L*LK*LS) * 1615 * 1618 M * 1618 (L*LK*LS) * 1619 (L)												
				1618 OF												
				1714 OF * 1721 OF * 1722 OF												
				1714 * 1714 (L*K*LK) * 1715 * 1718 * 1718 (A * AK) * K * 1720 L * 1721 * 1721 S * 1721 (L*LK) * 1722 S * 1723 * 1723 S * 1725 L												
				1819 (L*LAK*LB*LG*LK*LS) * 1820 LG												
				1924 (LS) * 1924 A (LS) * 1929 (L*LK*LS) * 1930 (LS) * 1932 (LS) * 1933 (LS) * 1934 (LS) * 1935 (L*LS) * 1938 * 1938 S * 1938 (L*LS) * 1941 (L*LS) * 1944 S * 1945 (L*LS)												
				2013 (L*LA*LAK*LB*LG*LK*LS) * 2013 6X2 (L) * 2014 (L*LB*LK) * 2016 (LB*LK) * 2017 (L*LB*LK)												
				2213 (L*LB*LK*LS) * 2213 6X6 (LA) * 2214 * 2215 (L*LB*LK*LS) * 2216 (L*LA*LAK*LB*LG*LK*LS) * 2217 (L*LB*LK*LS) * 2219 (L*LA*LAK*LB*LG*LK*LS) * 2220 * 2222 * 2225 (L*LB*LK*LS)												
				2314 (L*LB*LK*LS) * 2318 (L*LB*LK*LS) * 2325 (L*LB*LK*LS)												
				2414 (6X4) * 2414 (L) * 2418 (L*LB*LK) * 2420 (L*LB*LK) * 2423 B 6X4 * 2423 K 6X4 * 2425 6X6 (LA) * 2425 (L*LB*LK) * 2428 6X4												
				33275 / 33472		TRB		DINA	500 Serie	Eixo Traseiro / Eje Trasero / Rear Axle						
									CHRYSLER		D-600 * PD-600					
									DINA		400 Serie					
									FORD		F-600 * B-600					
									33281 / 33462		TRB		AGRALE	CHASSI MA 12.0E-TRONIC * MA 12.0SB E-TRONIC * MA 12.0 LE E-TRONIC	Eixo Traseiro / Eje Trasero / Rear Axle	
														DODGE		400 * 450 * 700 * 750 * 900 * 950
														FORD		F-350 Super Duty
																F-450 * F-450 Super Duty
																F-550 Super Duty
														VOLKSWAGEN		12-140 * 12-140 H * 12-140 T * 12-170 BT
33287 / 33462	TRB		CHRYSLER	D-600 * PD-600	Eixo Traseiro / Eje Trasero / Rear Axle											
				DODGE		400 * 450 * 700 * 750 * 900 * 950										
				FORD		F 100 (61...80 Diesel) * F 600 (56...77 Gas.) * F 700 (77...80) * F 750 (72...77) * 750 * 2000 * 4000										
						F-600 * B-600										
				FREIGHTLINER		FC 70										
						FL 60										
				GENERAL MOTORS		A-C-D 60* 70* 80* 90* 99 Turbo e 3500 Heavy Duty										
				MERCEDES BENZ		MBO 1017										
VOLKSWAGEN	11-130 * 11-140 * 11-160															
	12-140 * 12-140 H * 12-140 T * 12-170 BT															







Fersa®			Brand / Marca / Marca	Model / Modelo / Modelo	Application / Aplicação / Aplicaciones
33287 / 33462	TRB		MERCEDES BENZ	MBO 1017	Eixo Traseiro / Eje Trasero / Rear Axle
			CBT	Tratores 1000 * 1000 (4x4) * 1020 * 1020 (4x4) * 1065 * 1065 (4x4) * 1090 * 1105	
			VALTRA - VALMET	Tratores 685 * 685C (4x4) * 785 * 785C (4x4) * 880 Cafeeiro * 880 (4x4) * 885 * 980 (4x4) * 985 * 985F * 1180 * 1184	
3382 / 3320	TRB		MERCEDES BENZ	1418 OH * 1419 OH * 1420 (OH*OHL) * 1421 OHL	Caixa de Mudanças / Caja de Cambios / Gearbox
			MERCEDES BENZ	OH 1419 * OH 1420 * OH 1421 1214 C * 1214 K * 1214 (L*LK*LS) * 1215 * 1215 C * 1215 (L*LA*LK) * 1218 * 1218 R (L) 1215 OF * 1217 OF 1414 * 1414 (K*L*LA*LAK*LK) * 1418 * 1418 (E*K*R) * 1418 (L*LA*LAK*LK*R(LK)) * 1419 (L*LK*LS) * 1420 (L*LK*LS) 1417 OF * 1419 OF * 1421 OF 1421 OMC L1418 39 * L1418 52 * L1418 60 * L1419 59 * L1420. L1422	
			MERCEDES BENZ	1215 OF * 1217 OF 1417 OF * 1419 OF * 1421 OF 1421 OMC	
			MERCEDES BENZ	1417 OF * 1419 OF * 1421 OF 1421 OMC	
			MERCEDES BENZ	1517 OH * 1518 OH * 1519 OH * 1520 OH * 1521 OH	
			MERCEDES BENZ	1513 (L*LA*LAK*LB*LG*LK*LS) * 1514 (L*LK*LS) * 1516 (L*LA*LAK*LB*LG*LK*LS) * 1517 (L*LK) * 1518 (L*LK*LS) * 1519 (L*LAK*LB*LG*LK*LS) * 1520 (L*LK*LP*LPK*LPS*LS) * 1521 L * 1524 e 1525 (L*LK*LS) 1517 OF * 1518 OF * 1520 OF 1614 * 1615 (L*LK*LS) * 1615 * 1618 M * 1618 (L*LK*LS) * 1619 (L) 1618 OF 1819 (L*LAK*LB*LG*LK*LS) * 1820 LG 1924 (LS) * 1924 A (LS) * 1929 (L*LK*LS) * 1930 (LS) * 1932 (LS) * 1933 (LS) * 1934 (LS) * 1935 (L*LS) * 1938 * 1938 S * 1938 (L*LS) * 1941 (L*LS) * 1944 S * 1945 (L*LS) 2213 (L*LB*LK*LS) * 2213 6X6 (LA) * 2214 * 2215 (L*LB*LK*LS) * 2216 (L*LA*LAK*LB*LG*LK*LS) * 2217 (L*LB*LK*LS) * 2219 (L*LA*LAK*LB*LG*LK*LS) * 2220 * 2222 * 2225 (L*LB*LK*LS) 2314 (L*LB*LK*LS) * 2318 (L*LB*LK*LS) * 2325 (L*LB*LK*LS) Axor 2625 * 2628 * 2629 (L*K*LS) * 2631 (B*K*L) * 2632 * 2635 (B*K*L) * 2635 (L*LK*LS) * 2635 * 2638 (L*LK*LS) * Axor 2640 * 2641 * 2643 * Axor 2644 * Actos 2646 * 2648 * 2650 * 2651 * 2653 * 2654 (L*LK*LS) * 2657 * 2658 * 2644 * Atego 2628 (B*K) * 2625 * Axor 2826 * Axor 2828 * Axor 2831 2629 LS 2635 (L*LK*LS)	
33885 / 33822	TRB		MERCEDES BENZ	1517 OF * 1518 OF * 1520 OF 1618 OF	Caixa de Mudanças / Caja de Cambios / Gearbox
			MERCEDES BENZ	1517 OF * 1518 OF * 1520 OF 1618 OF	
33889 / 33822	TRB		MERCEDES BENZ	1517 OH * 1518 OH * 1519 OH * 1520 OH * 1521 OH	Caixa de Mudanças / Caja de Cambios / Gearbox
			VOLVO	9700 B 10M BR B 10R * B 12B * B 12R * B 58 * B 58BR * B 7R * B9 B 58 B 58 BR (...Chassi 304120)	
			MERCEDES BENZ	1513 (L*LA*LAK*LB*LG*LK*LS) * 1514 (L*LK*LS) * 1516 (L*LA*LAK*LB*LG*LK*LS) * 1517 (L*LK) * 1518 (L*LK*LS) * 1519 (L*LAK*LB*LG*LK*LS) * 1520 (L*LK*LP*LPK*LPS*LS) * 1521 L * 1524 e 1525 (L*LK*LS) 1517 OF * 1518 OF * 1520 OF 1614 * 1615 (L*LK*LS) * 1615 * 1618 M * 1618 (L*LK*LS) * 1619 (L) 1618 OF 1924 (LS) * 1924 A (LS) * 1929 (L*LK*LS) * 1930 (LS) * 1932 (LS) * 1933 (LS) * 1934 (LS) * 1935 (L*LS) * 1938 * 1938 S * 1938 (L*LS) * 1941 (L*LS) * 1944 S * 1945 (L*LS) 2213 (L*LB*LK*LS) * 2213 6X6 (LA) * 2214 * 2215 (L*LB*LK*LS) * 2216 (L*LA*LAK*LB*LG*LK*LS) * 2217 (L*LB*LK*LS) * 2219 (L*LA*LAK*LB*LG*LK*LS) * 2220 * 2222 * 2225 (L*LB*LK*LS) 2314 (L*LB*LK*LS) * 2318 (L*LB*LK*LS) * 2325 (L*LB*LK*LS) 2629 LS 2635 (L*LK*LS)	
			MERCEDES BENZ	1517 OF * 1518 OF * 1520 OF 1618 OF	
			MERCEDES BENZ	1819 (L*LAK*LB*LG*LK*LS) * 1820 LG	











Fersa*			Brand / Marca / Marca	Model / Modelo / Modelo	Application / Aplicação / Aplicaciones	
33895 / 33821	TRB		DINA	531 K * 532 J	Eixo Dianteiro / Eje Delantero / Front Axle	
			DINA	500 * 501		
33895 / 33822	TRB		MERCEDES BENZ	608 D * E (L*LO) * 708 D * E (L*LO) * 709 L * 710 L * 712 L	Eixo Traseiro / Eje Trasero / Rear Axle	
			MERCEDES BENZ	608 (L*LO) * 708 (L*LO) * 809 (LO*OF) * 812 (LO*OF) * 814 LO * 817 O * 914 LO * 709 * 710 * 712 * 712 C * 811 * 911 L * 912 * 913 * 914 * 914 C * 917		
			MERCEDES BENZ	L 608 * L 708 * L 709 * L 710 * L 712 * L 714 * L 715 * L 718 L 911 * L 912 * L 913 * L 914 LO 608 * LO 708		
			MERCEDES BENZ	LO 709 * LO 710 * LO 712		
34274 / 34492 A	TRB		DINA	604 G1 * 604 G3 * 604 L1 * 604 L5 * 631 K1 * 631 K3 * 661 C1 * 661 G1 * 661 G2 * 661 G3	Eixo Traseiro / Eje Trasero / Rear Axle	
34306 / 34478	TRB		DINA	434 17570 Shuttle Bus	Eixo Traseiro / Eje Trasero / Rear Axle	
			FREIGHTLINER	FL 60		
3585 / 3525	TRB		AGRALE	CHASSI MA 12.0E-TRONIC * MA 12.0SB E-TRONIC * MA 12.0 LE E-TRONIC	Eixo Dianteiro / Eje Delantero / Front Axle	
			CHRYSLER	D-600 * PD-600		
			FORD	Cargo 1113 * 1114 * 1116 * 1117		
				Cargo 1215		
				Cargo 1415 * 1416		
			VOLKSWAGEN	F 13000 * F 14000 * F 16000		
11-130 * 11-140 * 11-160						
3586 / 3525	TRB		JOHN DEERE	Diversos	Eixo / Eje / Axle	
			MARCHESAN	Grade Aradora Controle Remoto GACM Roçadeira RC 2 2600 CL * LSL * RC 2 3100	Caixa de Redução / Caja de Reducción / Reduction Box Caixa de Distribuição / Caja de Distribución / Distribution Box	
368 A / 362 A	TRB		AGRALE	CHASSI MA 8.5E-TRONIC * MA 9.2E-TRONIC * MA 9.2 GREEN E-TRONIC * MA 7.9E-MEC	Eixo Traseiro / Eje Trasero / Rear Axle	
			VOLKSWAGEN	8-100 * 8-140 (CO * CE) * 8-120 * 8-120 OD * 8-150 (E * EOD * OD) * 9-150 (EOD * OD)		
			AGRALE	6000E-MEC * 6000E-TRONIC FURGOVAN * 8000E-MEC FURGOVAN * 8500E-MEC * 8500CD-EMEC * 8500E-TRONIC		
			DODGE	400 * 450 * 700 * 750 * 900 * 950		
			FIAT	70 (77...) * 80		
			GENERAL MOTORS	6-100 (4X2) * 6-150 * 12-170 L*S (4X2) * 14-190 (77...) (4X2) * 15-190 (77...) (4X2) * 16-220 (4X2)		
			VOLKSWAGEN	5-140E Delivery * 5-140 EOD Volksbus		
				6-80 * 6-90 * 6-90 (P*S) 7-90 S * 7-100 * 7-110 S		
			FORD	F 350		Direção / Dirección / Steering
			GENERAL MOTORS	A-C-D (10*14*15*20*40) * Bonanza * Veraneio * D1000 Silverado		Eixo Traseiro / Eje Trasero / Rear Axle
368 A / 362 X	TRB		FORD	F 1000 (79...)	Diferencial / Diferencial / Differential	
			GENERAL MOTORS	D 10 D 20 (Bonanza * Veraneio)		
368 S / 362	TRB		SUDISA	EE4 * EH4	Eixo / Eje / Axle	
37431 / 37625	TRB	References Fersa with Multiple Applications / Referências Fersa com Múltiplas Aplicações / Referencias Fersa con Multiples Aplicaciones				
37431 A / 37625	TRB	References Fersa with Multiple Applications / Referências Fersa com Múltiplas Aplicações / Referencias Fersa con Multiples Aplicaciones				
3775 / 3720	TRB		DINA	300 Serie	Eixo Traseiro / Eje Trasero / Rear Axle	
3780 / 3720	TRB		MARCHESAN	Grade Aradora Controle Remoto Offset	Caixa de Redução / Caja de Reducción / Reduction Box	
				Grade Aradora Intermediária Controle Remoto GAICR * GAICR 300		
				Grade Aradora Pesada com Pneus GAPCW		
				Grade Aradora Super Pesada com Pneus GASPCW		



Fersa®			Brand / Marca / Marca	Model / Modelo / Modelo	Application / Aplicação / Aplicaciones
3782 / 3720			DINA	300 Serie	Eixo Dianteiro / Eje Delantero / Front Axle
				434 17570 Shuttle Bus	Eixo Traseiro / Eje Trasero / Rear Axle
				500 Serie	
				Citus 11000 * 9500	
				D-Avante Plus * D-Dorado	
				DPC311774 * DPT231770 * DPC311970 * DPT311770 * DPT351970 * DPT352171 * DPT352172 * DPX281770	
				DPX311970	
				F11 * F12 * F14	Eixo Dianteiro / Eje Delantero / Front Axle
				Marco Polo	
				Paradiso * Quadro	
				Viaggio	
		FORD	B-800		
		INTERNATIONAL	3000 RE	Caixa de Mudanças / Caja de Cambios / Gearbox	
			4700 FBC * 4700 FE (4X2) * 4700 SCD * 4700 SCD (444 * 466)		
		MASA	502 UX		
			Jaguar * Condor * Géminis * Halcón * Strada * Premier 2030F	Eixo Dianteiro / Eje Delantero / Front Axle	
			S 5000 * S 5002 * S 2030		
			S500T * S500U * S501U		
			Ursus		
		MERCEDES BENZ	O500M 1728 * O500R 1735	Caixa de Mudanças / Caja de Cambios / Gearbox	
			OH 1417 * OH 1418	Eixo Dianteiro / Eje Delantero / Front Axle	
			OMC 1628 58 Andare	Caixa de Mudanças / Caja de Cambios / Gearbox	
		MOTOR COACH	F11 * F11A		
			F12		
			F14		
			P11 * P12		
			P14	Eixo Dianteiro / Eje Delantero / Front Axle	
		VOLKSWAGEN	17-180 * 17-210 * 17-210 OD * 17-210 EOD * 17-220 * 17-220 Tractor * 17-240 OT * 17-250 Constellation * 17-250 OE * 17-260 EOT * 17-300 * 17-310 TITAN * 17-230 EOD		
			17-210		
			22-140 * 22-210 * 23-210 * 23-220 * 23-250 E * 23-310 TITAN		
		VOLVO	Busscar dos y tres ejes		
			C 10 * C 11		
			C 11R * C 12R	Caixa de Mudanças / Caja de Cambios / Gearbox	
U 12 * U 18 Articulado					
CHRYSLER	D-600 * PD-600				
	Ram 6500				
DINA	300 HTQ Serie				
	500 HTQ Serie				
	551				
	552 Q				
	553 19072 * 555 19070 * 661 25070 * 743 00300	Eixo Dianteiro / Eje Delantero / Front Axle			
	604 G1 * 604 G3 * 604 L1 * 604 L5 * 631 K1 * 631 K3 * 661 C1 * 661 G1 * 661 G2 * 661 G3				
	650 19570 Cab Over				
	702 * 707				
	702 * 707				
	751 Multi Torque				
	776				
861 K					
					







Fersa®			Brand / Marca / Marca	Model / Modelo / Modelo	Application / Aplicação / Aplicaciones		
3782 / 3720	TRB		DINA	D9 160 * D12 160 Cab Over	Caixa de Mudanças / Caja de Cambios / Gearbox		
				9400	Eixo Dianteiro / Eje Delantero / Front Axle		
				DCE 522570 * DCP 311970 * DCP 311 771 * DCP 351972			
			FAMSA	DC 10264 Autocar	Eixo Dianteiro / Eje Delantero / Front Axle		
				L1100, L1200, L1300, L1400, L1500, L1600, L2121			
			FORD	Cargo 1313 * 1314 * 1317 * 1317E	Caixa de Mudanças / Caja de Cambios / Gearbox		
				Cargo 1422 * 1514 * 1517 * 1517E * 1615 * 1615T * 1617 * 1618 * 1618T * 1619 * 1621 * 1622 * 1717E * 1722 * 1722E * 2216 * 2217 * 2218 * 2218T * 2319 * 2322 * 2324 * 2422 * 2422E * 2425 * 2428E * 2630 * 3224 * 3530 * 4030			
				F-700	Eixo Dianteiro / Eje Delantero / Front Axle		
				F-800	Caixa de Mudanças / Caja de Cambios / Gearbox		
				LM-700	Eixo Dianteiro / Eje Delantero / Front Axle		
			FREIGHTLINER	Argosy		Eixo Dianteiro / Eje Delantero / Front Axle	
				C-120 * Columbia * Coronado * CST 120			
				FC 70			
				FC 80			
				FL 106			
				FL 112 6X4			
				FL 70			
			FREIGHTLINER	FL 80 * FL 80 QR 4X2		Caixa de Mudanças / Caja de Cambios / Gearbox	
				FLD 120		Eixo Dianteiro / Eje Delantero / Front Axle	
				FS 65	Caixa de Mudanças / Caja de Cambios / Gearbox		
				L-112	Eixo Dianteiro / Eje Delantero / Front Axle		
				MT45 * MT45A. M2 52K 6X2	Caixa de Mudanças / Caja de Cambios / Gearbox		
			GENERAL MOTORS	6-100 (4X2)* 6-150* 12-170 L*S (4X2)* 14-190 (77...) (4X2)* 15-190 (77...) (4X2)* 16-220 (4X2)			
				Kodiak	Eixo Dianteiro / Eje Delantero / Front Axle		
			INTERNATIONAL	4700		Eixo Dianteiro / Eje Delantero / Front Axle	
				7400			
				4200 VT 365 * 4300 DT 466 / 195 HP		Caixa de Mudanças / Caja de Cambios / Gearbox	
				INTERNATIONAL		4400-215HP 4X2 * 4400-250HP * 4400-285HP * 4400-300HP	Eixo Dianteiro / Eje Delantero / Front Axle
						4900 DT 466E	Caixa de Mudanças / Caja de Cambios / Gearbox
						4900-210HP * 4900-215HP * 4900-250HP * 4900-300HP	
				9200 * 9200i * 9400 * 9400i * Day Cab * Day Cab DDC		Eixo Dianteiro / Eje Delantero / Front Axle	
			KENWORTH	T2000		Caixa de Mudanças / Caja de Cambios / Gearbox	
				T300 4X2 * 6X4			
				T450, T450 B, T450 W	Eixo Dianteiro / Eje Delantero / Front Axle		
				T800 * Aerocab * Modular * SHW (Short hood wide) * HB * BSH Aerocab * SH 6X4 * 8X4			
				W900 * W924			
			MACK	CH Day Cab * CH Premium * CH Select * CH Elite * CX Vision	Caixa de Mudanças / Caja de Cambios / Gearbox		
			MERCEDES BENZ	L1113 * L1114 * L1116 * L1117 * L1118		Eixo Dianteiro / Eje Delantero / Front Axle	
				L1214 * L1215 * L1217 39 * L1217 52 * L1218 52			
				L1313 * L1314 * L1315 * L1316 * L1317 * L1318 * L1319 * L1321		Caixa de Mudanças / Caja de Cambios / Gearbox	
				L1417 52			
				L1418 39 * L1418 52 * L1418 60 * L1419 59 * L1420. L1422			
				L1518 52			
			L1617 59	Eixo Dianteiro / Eje Delantero / Front Axle			













Fersa®			Brand / Marca / Marca	Model / Modelo / Modelo	Application / Aplicação / Aplicaciones
3782 / 3720	TRB		MERCEDES BENZ	L1619 52	Eixo Dianteiro / Eje Delantero / Front Axle
				L1621 52	
				L2121 54	
				L2221	
				LK1417 34	
				LK1418 39 * LK1418 52	
				MBO 1018 44	Caixa de Mudanças / Caja de Cambios / Gearbox
				MBO 1019 44 Boxer	Eixo Dianteiro / Eje Delantero / Front Axle
				MBO 1217	Caixa de Mudanças / Caja de Cambios / Gearbox
				MBO 1219 52 Boxer	Eixo Dianteiro / Eje Delantero / Front Axle
				MBO 1417	Caixa de Mudanças / Caja de Cambios / Gearbox
				MBO 1418 60	Eixo Dianteiro / Eje Delantero / Front Axle
				MBO 1419 60 Boxer	Caixa de Mudanças / Caja de Cambios / Gearbox
				MBO 1621	Eixo Dianteiro / Eje Delantero / Front Axle
				OF 1313 * OF 1314 * OF 1315 * OF 1316 * OF 1317 * OF 1318 51	Caixa de Mudanças / Caja de Cambios / Gearbox
				OMC 1418 51 * OMC 1418 60	Eixo Dianteiro / Eje Delantero / Front Axle
				OMC 1419 51	Caixa de Mudanças / Caja de Cambios / Gearbox
				OMC 1423 51 Torino	Eixo Dianteiro / Eje Delantero / Front Axle
				OMC 1421 51	Caixa de Mudanças / Caja de Cambios / Gearbox
				OMC 1425 51 Allegro	Eixo Dianteiro / Eje Delantero / Front Axle
				LO 1417 59	Caixa de Mudanças / Caja de Cambios / Gearbox
				OF 1416 * OF 1417 * OF 1418 * OF 1419 * OF 1420 * OF 1421	Eixo Dianteiro / Eje Delantero / Front Axle
				AT 9500	Eixo Dianteiro / Eje Delantero / Front Axle
				L7500	Eixo Dianteiro / Eje Delantero / Front Axle
		LT7500	Eixo Dianteiro / Eje Delantero / Front Axle		
		LT9500	Eixo Dianteiro / Eje Delantero / Front Axle		
		M8500 Acterra	Eixo Dianteiro / Eje Delantero / Front Axle		
		ST9500 Silver Star	Eixo Dianteiro / Eje Delantero / Front Axle		
		14-140 * 14-150 * 14-170 BT * 14-180 * 14-200 * 14-210 * 14-220	Eixo Dianteiro / Eje Delantero / Front Axle		
		15-170 * 15-170E * 15-180 * 15-180E * 15-180 OD * 15-190 (77...) * 15-190 (77...)EOD	Eixo Dianteiro / Eje Delantero / Front Axle		
		16-170 * 16-180 * 16-200 * 16-210 * 16-220 CO * 16300	Eixo Dianteiro / Eje Delantero / Front Axle		
		18-310 TITAN * 18-310 OT	Eixo Dianteiro / Eje Delantero / Front Axle		
		19-320 TITAN Tractor Constellation	Eixo Dianteiro / Eje Delantero / Front Axle		
		24-220 * 24-250 * 24-250 Constellation * 24-250E * 26-220 * 26-260E * 26-300	Eixo Dianteiro / Eje Delantero / Front Axle		
		31-260E * 35-300 * 40-300	Eixo Dianteiro / Eje Delantero / Front Axle		
		D 1400 TD * Volksbus	Eixo Dianteiro / Eje Delantero / Front Axle		
		E 13 * E 21	Eixo Dianteiro / Eje Delantero / Front Axle		
		Autocar / VHD 64B 6X4	Eixo Dianteiro / Eje Delantero / Front Axle		
		Autohailer 6X4	Eixo Dianteiro / Eje Delantero / Front Axle		
		NE 64 6X4 * NR 64 T	Eixo Dianteiro / Eje Delantero / Front Axle		
		VNL 64T * 420 6X4 * 430 * 610 6X4 * 630 * 660 * 670 * 673 * DAY * DAY CAB	Eixo Dianteiro / Eje Delantero / Front Axle		
		311 * 312 * 314 * 362 * 315G * 316G * 317G6 * 318G * 319G * 321C * 323G	Eixo Dianteiro / Eje Delantero / Front Axle		
		541 * 542	Eixo Dianteiro / Eje Delantero / Front Axle		
		555 OF	Eixo Dianteiro / Eje Delantero / Front Axle		
		651 * 653 * 654 * 661 * 741	Eixo Dianteiro / Eje Delantero / Front Axle		
		654 21071	Eixo Dianteiro / Eje Delantero / Front Axle		
		LO 1417 59	Eixo Dianteiro / Eje Delantero / Front Axle		
			Eixo Dianteiro / Eje Delantero / Front Axle		
	Eixo Dianteiro / Eje Delantero / Front Axle				
	Eixo Dianteiro / Eje Delantero / Front Axle				
	Eixo Dianteiro / Eje Delantero / Front Axle				
	Eixo Dianteiro / Eje Delantero / Front Axle				
	Eixo Dianteiro / Eje Delantero / Front Axle				
	Eixo Dianteiro / Eje Delantero / Front Axle				
	Eixo Dianteiro / Eje Delantero / Front Axle				
	Eixo Dianteiro / Eje Delantero / Front Axle				
	Eixo Dianteiro / Eje Delantero / Front Axle				
	Eixo Dianteiro / Eje Delantero / Front Axle				
	Eixo Dianteiro / Eje Delantero / Front Axle				
	Eixo Dianteiro / Eje Delantero / Front Axle				
	Eixo Dianteiro / Eje Delantero / Front Axle				
	Eixo Dianteiro / Eje Delantero / Front Axle				









Fersa*			Brand / Marca / Marca	Model / Modelo / Modelo	Application / Aplicação / Aplicaciones
3782 / 3720	TRB		MERCEDES BENZ	MBO 1018 44	Caixa de Mudanças / Caja de Cambios / Gearbox
				MBO 1019 44 Boxer	
				MBO 1217	Eixo Dianteiro / Eje Delantero / Front Axle
				MBO 1219 52 Boxer	Caixa de Mudanças / Caja de Cambios / Gearbox
				MBO 1417	Eixo Dianteiro / Eje Delantero / Front Axle
				MBO 1418 60	Caixa de Mudanças / Caja de Cambios / Gearbox
				MBO 1419 60 Boxer	Eixo Dianteiro / Eje Delantero / Front Axle
				MBO 1621	Caixa de Mudanças / Caja de Cambios / Gearbox
				OF 1313 * OF 1314 * OF 1315 * OF 1316 * OF 1317 * OF 1318 51	Eixo Dianteiro / Eje Delantero / Front Axle
				OF 1416 * OF 1417 * OF 1418 * OF 1419 * OF 1420 * OF 1421	
				OMC 1418 51 * OMC 1418 60	
				OMC 1419 51	Caixa de Mudanças / Caja de Cambios / Gearbox
				OMC 1421 51	Eixo Dianteiro / Eje Delantero / Front Axle
				OMC 1425 51 Allegro	Caixa de Mudanças / Caja de Cambios / Gearbox
				387 / 382 A	TRB
FORD	F 100 (61...80 Diesel) * F 600 (56...77 Gas.) * F 700 (77...80) * F 750 (72...77) * 750 * 2000 * 4000 F 7000 * FT 7000 e FT 8000 (77...80); F 8000 e F 8500 (77...79) * FT 8500				
387 A / 382 A	TRB		AGCO MAXION	Colheitadeira Combinada MF1130 - Arrozadeira * 5650 - Arrozadeira	Eixo Dianteiro / Eje Delantero / Front Axle
			JOHN DEERE	Tratores 5403 * 5600 Aeroportuário * 5605 * 5705 * 6605 * 7500 Aeroportuário * 7505	Embreagem / Embrague / Clutch
			FAMSA	DC 9964 Autocar	Eixo Traseiro / Eje Trasero / Rear Axle
			GENERAL MOTORS	6-100 (4X2)* 6-150* 12-170 L*S (4X2)* 14-190 (77...)(4X2)* 15-190 (77...)(4X2)* 16-220 (4X2)	
			SUDISA	EA4	Eixo / Eje / Axle
			VOLKSWAGEN	6-80 * 6-90 * 6-90 (P*S)	Eixo Traseiro / Eje Trasero / Rear Axle
			FORD	Excursion	Eixo Traseiro / Eje Trasero / Rear Axle
				F 2000 (80...)	
				F 350	Diferencial / Diferencial / Differential
				F 400	
				F 4000 (75...)	
			GENERAL MOTORS	F 250	
F 350					
F 450					
Microbus	Eixo Traseiro / Eje Trasero / Rear Axle				
Mustang					
GENERAL MOTORS	C 2500				
	C 3500				
	Express Van				









Fersa®			Brand / Marca / Marca	Model / Modelo / Modelo	Application / Aplicação / Aplicaciones
387 A / 382 A	TRB		GENERAL MOTORS	P 30	Eixo Traseiro / Eje Trasero / Rear Axle
				Silverado 2500	
				Silverado 3500	
				Suburban	
387 A / 382 S	TRB		CHRYSLER	Ram 6500	Eixo Traseiro / Eje Trasero / Rear Axle
			FORD	F-350 * P-350 F-450 * F-450 Super Duty	
387 A / 383 A	TRB	References Fersa with Multiple Applications / Referências Fersa com Múltiplas Aplicações / Referencias Fersa con Multiples Aplicaciones			
387 AS / 382 A	TRB		FORD	F-350 * P-350	Eixo Traseiro / Eje Trasero / Rear Axle
			GENERAL MOTORS	C-3500	
388 A / 382	TRB		SUDISA	EE4 * EH4	Eixo / Eje / Axle
39250 / 39412	TRB		FORD	F-350 Super Duty	Eixo Traseiro / Eje Trasero / Rear Axle
				F-450 * F-450 Super Duty	
				F-550 Super Duty	
395 A / 394 A	TRB	References Fersa with Multiple Applications / Referências Fersa com Múltiplas Aplicações / Referencias Fersa con Multiples Aplicaciones			
39580 / 39520	TRB		VOLVO	7550	Eixo Dianteiro / Eje Delantero / Front Axle
				B 10M BR	
				B 10R * B 12B * B 12R * B 58 * B 58BR * B 7R * B9	
39581 / 39520	TRB		VOLVO	N * NL 10 BR * N * NL 12 BR * N 10BR Mark II * NL 10BR 6x2	Eixo Traseiro / Eje Trasero / Rear Axle
			AGRALE	CHASSI MA 12.0E-TRONIC * MA 12.0SB E-TRONIC * MA 12.0 LE E-TRONIC	Eixo Dianteiro / Eje Delantero / Front Axle
			CHRYSLER	D-600 * PD-600	
			FORD	Cargo 1113 * 1114 * 1116 * 1117 F 13000 * F 14000 * F 16000	
			VOLKSWAGEN	11-130 * 11-140 * 11-160	
				12-140 * 12-140 H * 12-140 T * 12-170 BT	
				13-130 * 13-150 * 13-170 * 13-180E * 13-190 (77...)E * 13-210	
39585 / 39520	TRB		DODGE	Ram 2500 Ram 4000	Eixo Traseiro / Eje Trasero / Rear Axle
			39590 / 39520	TRB	
DINA	434 17570 Shuttle Bus DPX311970				
INTERNATIONAL	3000 RE				
MERCEDES BENZ	O500M 1728 * O500R 1735	Caixa de Mudanças / Caja de Cambios / Gearbox			
	OH 1417 * OH 1418	Eixo Traseiro / Eje Trasero / Rear Axle			
VOLVO	OMC 1628 58 Andare	Caixa de Mudanças / Caja de Cambios / Gearbox			
AGRALE	9200E-TRONIC	Eixo Traseiro / Eje Trasero / Rear Axle			
CHRYSLER	D-600 * PD-600				
DINA	300 HTQ Serie				
	531 K * 532 J				
	551				
	552 Q				
	553 19072 * 555 19070 * 661 25070 * 743 00300				
	604 G1 * 604 G3 * 604 L1 * 604 L5 * 631 K1 * 631 K3 * 661 C1 * 661 G1 * 661 G2 * 661 G3				
	650 19570 Cab Over				
D9 160 * D12 160 Cab Over	Caixa de Mudanças / Caja de Cambios / Gearbox				
DODGE	400 * 450 * 700 * 750 * 900 * 950	Eixo Traseiro / Eje Trasero / Rear Axle			
FAMSA	L1100, L1200, L1300, L1400, L1500, L1600, L2121				
FORD	Cargo 1113 * 1114 * 1116 * 1117				
	Cargo 1415 * 1416				
	Cargo 1422 * 1514 * 1517 * 1517E * 1615 * 1615T * 1617 * 1618 * 1618T * 1619 * 1621 * 1622 * 1717E * 1722 * 1722E * 2216 * 2217 * 2218 * 2218T * 2319 * 2322 * 2324 * 2422 * 2422E * 2425 * 2428E * 2630 * 3224 * 3530 * 4030	Caixa de Mudanças / Caja de Cambios / Gearbox			



Fersa*			Brand / Marca / Marca	Model / Modelo / Modelo	Application / Aplicação / Aplicaciones
39590 / 39520	TRB		FORD	F 100 (61...80 Diesel) * F 600 (56...77 Gas.) *	Eixo Traseiro / Eje Trasero / Rear Axle
				F 700 (77...80) * F 750 (72...77) * 750 * 2000 * 4000	
				F 11000 * F 12000	
				F 19000 (77...) * F 21000 * F 22000	
				F 7000 * FT 7000 e FT 8000 (77...80); F 8000 e F 8500 (77...79) * FT 8500	
				F-600 * B-600	
			FREIGHTLINER	F-800	Caixa de Mudanças / Caja de Cambios / Gearbox
				FC 70	Eixo Traseiro / Eje Trasero / Rear Axle
				FL 106	
				FL 70	
				FL 80 * FL 80 QR 4X2	Caixa de Mudanças / Caja de Cambios / Gearbox
			GENERAL MOTORS	FS 65	Eixo Traseiro / Eje Trasero / Rear Axle
				MT45 * MT45A. M2 52K 6X2	Caixa de Mudanças / Caja de Cambios / Gearbox
				6-100 (4X2)* 6-150* 12-170 L*S (4X2)* 14-190 (77...) (4X2)* 15-190 (77...) (4X2)* 16-220 (4X2)	
				6-100 (4X2)* 6-150* 12-170 L*S (4X2)* 14-190 (77...) (4X2)* 15-190 (77...) (4X2)* 16-220 (4X2)	
			INTERNATIONAL	A-C-D 60* 70* 80* 90* 99 Turbo e 3500 Heavy Duty	Eixo Traseiro / Eje Trasero / Rear Axle
				Kodiak	Caixa de Mudanças / Caja de Cambios / Gearbox
				4200 VT 365 * 4300 DT 466 / 195 HP	Eixo Traseiro / Eje Trasero / Rear Axle
			4400-215HP 4X2 * 4400-250HP * 4400-285HP * 4400-300HP		
			KENWORTH	4700 (4X2)* 4900 (16 ton.)	Caixa de Mudanças / Caja de Cambios / Gearbox
				T300 4X2 * 6X4	Eixo Traseiro / Eje Trasero / Rear Axle
			MERCEDES BENZ	L1113 * L1114 * L1116 * L1117 * L1118	
				L1214 * L1215 * L1217 39 * L1217 52 * L1218 52	Eixo Traseiro / Eje Trasero / Rear Axle
				L1313 * L1314 * L1315 * L1316 * L1317 * L1318 * L1319 * L1321	Caixa de Mudanças / Caja de Cambios / Gearbox
				L1518 52	Eixo Traseiro / Eje Trasero / Rear Axle
				LK1417 34	Caixa de Mudanças / Caja de Cambios / Gearbox
				MBO 1018 44	Eixo Traseiro / Eje Trasero / Rear Axle
				MBO 1019 44 Boxer	Caixa de Mudanças / Caja de Cambios / Gearbox
				MBO 1217	Eixo Traseiro / Eje Trasero / Rear Axle
				MBO 1219 52 Boxer	Caixa de Mudanças / Caja de Cambios / Gearbox
				MBO 1417	Eixo Traseiro / Eje Trasero / Rear Axle
				MBO 1418 60	Caixa de Mudanças / Caja de Cambios / Gearbox
				MBO 1419 60 Boxer	Eixo Traseiro / Eje Trasero / Rear Axle
				OF 1313 * OF 1314 * OF 1315 * OF 1316 * OF 1317 * OF 1318 51	Caixa de Mudanças / Caja de Cambios / Gearbox
				OMC 1418 51 * OMC 1418 60	Eixo Traseiro / Eje Trasero / Rear Axle
				OMC 1419 51	Caixa de Mudanças / Caja de Cambios / Gearbox
				OMC 1423 51 Torino	Eixo Traseiro / Eje Trasero / Rear Axle
				OMC 1425 51 Allegro	Caixa de Mudanças / Caja de Cambios / Gearbox
				VOLKSWAGEN	LO 1417 59
			OF 1416 * OF 1417 * OF 1418 * OF 1419 * OF 1420 * OF 1421		Caixa de Mudanças / Caja de Cambios / Gearbox
			12-140 * 12-140 H * 12-140 T * 12-170 BT	Eixo Traseiro / Eje Trasero / Rear Axle	
			13-130 * 13-150 * 13-170 * 13-180E * 13-190 (77...)E * 13-210	Caixa de Mudanças / Caja de Cambios / Gearbox	











Fersa®			Brand / Marca / Marca	Model / Modelo / Modelo	Application / Aplicação / Aplicaciones		
39590 / 39520	TRB		DINA	400	Eixo Traseiro / Eje Trasero / Rear Axle		
				451			
				431K * 432K * 432J * 432J1 * 432J2			
				433 16070			
				455 OF			
				500 * 501			
				541 * 542			
				555 OF			
			654 21071				
			OF 1416 * OF 1417 * OF 1418 * OF 1419 * OF 1420 * OF 1421				
			LO 1417 59				
			MBO 1018 44	Caixa de Mudanças / Caja de Cambios / Gearbox Eixo Traseiro / Eje Trasero / Rear Axle			
			MBO 1019 44 Boxer	Caixa de Mudanças / Caja de Cambios / Gearbox Eixo Traseiro / Eje Trasero / Rear Axle			
			MBO 1217	Caixa de Mudanças / Caja de Cambios / Gearbox Eixo Traseiro / Eje Trasero / Rear Axle			
		MBO 1219 52 Boxer	Caixa de Mudanças / Caja de Cambios / Gearbox Eixo Traseiro / Eje Trasero / Rear Axle				
		MBO 1417	Caixa de Mudanças / Caja de Cambios / Gearbox Eixo Traseiro / Eje Trasero / Rear Axle				
		MBO 1418 60	Caixa de Mudanças / Caja de Cambios / Gearbox Eixo Traseiro / Eje Trasero / Rear Axle				
		MBO 1419 60 Boxer	Caixa de Mudanças / Caja de Cambios / Gearbox Eixo Traseiro / Eje Trasero / Rear Axle				
		OF 1313 * OF 1314 * OF 1315 * OF 1316 * OF 1317 * OF 1318 51	Eixo Traseiro / Eje Trasero / Rear Axle				
		OMC 1418 51 * OMC 1418 60	Eixo Traseiro / Eje Trasero / Rear Axle				
		OMC 1419 51	Caixa de Mudanças / Caja de Cambios / Gearbox Eixo Traseiro / Eje Trasero / Rear Axle				
		OMC 1421 51	Caixa de Mudanças / Caja de Cambios / Gearbox Eixo Traseiro / Eje Trasero / Rear Axle				
		OMC 1425 51 Allegro	Caixa de Mudanças / Caja de Cambios / Gearbox Eixo Traseiro / Eje Trasero / Rear Axle				
			AGCO MAXION		Eixo Traseiro / Eje Trasero / Rear Axle		
		JOHN DEERE	Tratores MF (50X * 55X * 65R * 65X * 85 * 85X * 95 * 95X)	Eixo Dianteiro e Traseiro / Eje Delantero y Trasero / Front and Rear Axle			
			VOLKSWAGEN	D 1400 TD * Volksbus E 13 * E 21	Caixa de Mudanças / Caja de Cambios / Gearbox		
		3982 / 3920	TRB		AGRALE	CHASSI MA 8.5E-TRONIC * MA 9.2E-TRONIC * MA 9.2 GREEN E-TRONIC * MA 7.9E-MEC	Eixo Traseiro / Eje Trasero / Rear Axle
					VOLKSWAGEN	8-100 * 8-140 (CO * CE) * 8-120 * 8-120 OD * 8-150 (E * EOD * OD) * 9-150 (EOD * OD)	
AGRALE	6000E-MEC * 6000E-TRONIC FURGOVAN * 8000E-MEC FURGOVAN * 8500E-MEC * 8500CD-EMEC * 8500E-TRONIC						
CHRYSLER	D-600 * PD-600						
DODGE	400 * 450 * 700 * 750 * 900 * 950						
FAMSA	DC 9964 Autocar						
FIAT	70 (77...) * 80						
	FORD			Cargo 814 Cargo 815 * 815 E F 100 (61...80 Diesel) * F 600 (56...77 Gas.) * F 700 (77...80) * F 750 (72...77) * 750 * 2000 * 4000 F-600 * B-600			
	FREIGHTLINER			FC 70 FL 60			
	GENERAL MOTORS			6-100 (4X2) * 6-150 * 12-170 L*S (4X2) * 14-190 (77...) (4X2) * 15-190 (77...) (4X2) * 16-220 (4X2)			
	MERCEDDES BENZ			MBO 1017			





Fersa*			Brand / Marca / Marca	Model / Modelo / Modelo	Application / Aplicação / Aplicaciones
3982 / 3920	TRB		VOLKSWAGEN	5-140E Delivery * 5-140 EOD Volksbus	Eixo Traseiro / Eje Trasero / Rear Axle
				6-80 * 6-90 * 6-90 (P*S)	
				7-90 S * 7-100 * 7-110 S	
			MERCEDES BENZ	MBO 1017	
				AGCO MAXION	Colheitadeira Combinada MF1130 - Arroeira * 5650 - Arroeira
			BALDAN	Grade super pesada GSPCR	Arado / Arado / Plow
			JOHN DEERE	Tratores 5403 * 5600 Aeroportuário * 5605 * 5705 * 6605 * 7500 Aeroportuário * 7505	Tomada de Força / Toma de Fuerza / Power Take-off
			MARCHESAN	Arado Fixo AF * Arado Fixo Canavieiro AFC * Arado Fixo Leve AFL	Eixo Traseiro / Eje Trasero / Rear Axle
				Arado Subsolador Hidráulico Tatu AST/ Arado Subsolador Mecânico Tatu AST	
				Grade Aradora GA	
				Grade Aradora Mecânica GAM * GATCR	
			VALTRA - VALMET	Raspadeira Agrícola STA * STA 3 RT	Caixa de Redução / Caja de Reducción / Reduction Box
Roçadeira RC 2 1300 * RC 2 1500 * RC 2 1700					
COCHE	FORD	F 4000			
	GENERAL MOTORS	A-C-D (10*14*15*20*40) * Bonanza * Veraneio * D1000 Silverado	Eixo Traseiro / Eje Trasero / Rear Axle		
3984 / 3920	TRB		AGCO MAXION	Tratores MF 235 (4x4) Antigo * MF 235 Moderno* 250 * 265 * MF265 RD * 270 * 274 * 275 * 285 * 290 * MF 292 (4x4) * 295 * 296 * 299	Diferencial / Diferencial / Differential
				Tratores MF (50X * 55X * 65R * 65X * 85 * 85X * 95 * 95X)	Eixo Traseiro / Eje Trasero / Rear Axle
			FNH	Tratores 4600 * 4610 * 4630 * 5600 * 5610 * 5630 * 6600 * 6610 * 6630 * 7610 * 7630 * 7810 * 7830 * 8030 * 8BR	
			JOHN DEERE	Colheitadeiras CA9650 * CA9750 STS	Caixa de Engrenagens de 2 Velocidades / Caja de Engranajes de 2 Velocidades / 2 Speed Gearbox
				Tratores 5403 * 5600 Aeroportuário * 5605 * 5705 * 6605 * 7500 Aeroportuário * 7505	Tomada de Força / Toma de Fuerza / Power Take-off
			MARCHESAN	Grade Aradora Controle Remoto GACM	Caixa de Redução / Caja de Reducción / Reduction Box
		Grade Aradora Hidráulica GAH Grade Aradora Mecânica GAM * GATCR			
		MASSEY FERGUSON	MF50X * MF55X * MF65R * MF65X * MF85 * MF85X * MF95 * MF95X	Diferencial / Diferencial / Differential	
			MERCEDES BENZ	608 D * E (L*LO) * 708 D * E (L*LO) * 709 L * 710 L * 712 L	Eixo Traseiro / Eje Trasero / Rear Axle
				812 LO * 912 L	
3994 / 3920	TRB		DINA	500 Serie	Eixo Traseiro / Eje Trasero / Rear Axle
			DINA	531 K * 532 J	
42346 / 42584	TRB		MASA	S500T * S500U * S501U	Eixo Traseiro / Eje Trasero / Rear Axle
			DINA	604 G1 * 604 G3 * 604 L1 * 604 L5 * 631 K1 * 631 K3 * 661 C1 * 661 G1 * 661 G2 * 661 G3	
42350 / 42584	TRB		DINA	761	Eixo Traseiro / Eje Trasero / Rear Axle
42368 / 42584	TRB		VALTRA - VALMET	Tratores 60 * 60 ID * 62 * 65 * 65 Cafeeiro * 68 * 68 Cafeeiro * 78 * 80 * M80 * 85 * 85ID * 86 * 86 ID * 88 * 88 ID	Câmbio / Caja de Cambios / Gearbox
				Tratores 110 ID * 110ID II * 118 * 118 (4x4) * 128 * 128 (4x4)	Eixo Traseiro / Eje Trasero / Rear Axle
				Tratores 685 * 685C (4x4) * 785 * 785C (4x4) * 880 Cafeeiro * 880 (4x4) * 885 * 980 (4x4) * 985 * 985F * 1180 * 1184	Câmbio / Caja de Cambios / Gearbox
42381 / 42584	TRB		MASA	500 Serie	Eixo Traseiro / Eje Trasero / Rear Axle
				S500T * S500U * S501U	
			DINA	300 HTQ Serie	
				531 K * 532 J	
				761	
FAMSA	DC 9964 Autocar				
FORD	Cargo 1113 * 1114 * 1116 * 1117 Cargo 1215				











Fersa®			Brand / Marca / Marca	Model / Modelo / Modelo	Application / Aplicação / Aplicaciones	
42381 / 42584	TRB		FORD	Cargo 1313 * 1314 * 1317 * 1317E	Eixo Traseiro / Eje Trasero / Rear Axle	
				Cargo 1415 * 1416		
				Cargo 1422 * 1514 * 1517 * 1517E * 1615 * 1615T * 1617 * 1618 * 1618T * 1619 * 1621 * 1622 * 1717E * 1722 * 1722E * 2216 * 2217 * 2218 * 2218T * 2319 * 2322 * 2324 * 2422 * 2422E * 2425 * 2428E * 2630 * 3224 * 3530 * 4030		
			FREIGHTLINER	FL 70		
			GENERAL MOTORS	6-100 (4X2)* 6-150* 12-170 L*S (4X2)* 14-190 (77...) (4X2)* 15-190 (77...) (4X2)* 16-220 (4X2)		
			MERCEDES BENZ	MBO 1018 44		
		VOLKSWAGEN	MBO 1019 44 Boxer			
			11-130 * 11-140 * 11-160			
			12-140 * 12-140 H * 12-140 T * 12-170 BT			
			CBT	2070 * 2080 * 2100 * 2105 (4x2) * 2400 * 2400 (4x4) * 2500 * 2600		Câmbio / Caja de Cambios / Gearbox
				Tratores 1000 * 1000 (4x4) * 1020 * 1020 (4x4) * 1065 * 1065 (4x4) * 1090 * 1105		
				Tratores 1280 * 1284 * 1580 * 1780 * 1780 (4x4) * 1380 * 1680 * 1880 * 118 * 128 * 138 * 148 * 148 (4x4)		
VALTRA - VALMET	Tratores 685 * 685C (4x4) * 785 * 785C (4x4) * 880 Cafeeiro * 880 (4x4) * 885 * 980 (4x4) * 985 * 985F * 1180 * 1184	Eixo Traseiro / Eje Trasero / Rear Axle				
	Tratores 870 CN * CK	Tração Dianteira / Tracción Delantera / Front Traction				
		Câmbio / Caja de Cambios / Gearbox				
42688 / 42620	TRB		DODGE	400 * 450 * 700 * 750 * 900 * 950	Eixo Traseiro / Eje Trasero / Rear Axle	
			FORD	F 11000 * F 12000		
45284 / 45220	TRB		VOLVO	C 11R * C 12R	Caixa de Mudanças / Caja de Cambios / Gearbox	
			CHRYSLER	D-600 * PD-600	Eixo Dianteiro / Eje Delantero / Front Axle	
				DINA	400 Serie	
			D9 160 * D12 160 Cab Over	Caixa de Mudanças / Caja de Cambios / Gearbox		
			DODGE	400 * 450 * 700 * 750 * 900 * 950	Eixo Dianteiro / Eje Delantero / Front Axle	
				FORD	Cargo 1422 * 1514 * 1517 * 1517E * 1615 * 1615T * 1617 * 1618 * 1618T * 1619 * 1621 * 1622 * 1717E * 1722 * 1722E * 2216 * 2217 * 2218 * 2218T * 2319 * 2322 * 2324 * 2422 * 2422E * 2425 * 2428E * 2630 * 3224 * 3530 * 4030	Caixa de Mudanças / Caja de Cambios / Gearbox
			F 100 (61...80 Diesel) * F 600 (56...77 Gas.) * F 700 (77...80) * F 750 (72...77) * 750 * 2000 * 4000			
			F 11000 * F 12000			
			F 13000 * F 14000 * F 16000			
			F 19000 (77...) * F 21000 * F 22000			
			F 7000 * FT 7000 e FT 8000 (77...80); F 8000 e F 8500 (77...79) * FT 8500			
			F-600 * B-600			
			F-800	Eixo Dianteiro / Eje Delantero / Front Axle		
			FREIGHTLINER	FS 65	Caixa de Mudanças / Caja de Cambios / Gearbox	
			GENERAL MOTORS	A-C-D 60* 70* 80* 90* 99 Turbo e 3500 Heavy Duty	Eixo Dianteiro / Eje Delantero / Front Axle	
				Kodiak	Eixo Traseiro / Eje Trasero / Rear Axle	
			KENWORTH	T300 4X2 * 6X4	Caixa de Mudanças / Caja de Cambios / Gearbox	
			MACK	RD688S * RD690	Eixo Dianteiro / Eje Delantero / Front Axle	
		MERCEDES BENZ	OMC 1423 51 Torino	Caixa de Mudanças / Caja de Cambios / Gearbox		
		VOLKSWAGEN	E 13 * E 21			
			DINA	400	Eixo Dianteiro / Eje Delantero / Front Axle	
				451		
431K * 432K * 432J * 432J1 * 432J2						
MERCEDES BENZ	OMC 1421 51	Caixa de Mudanças / Caja de Cambios / Gearbox				
	AGCO MAXION	Colhetadeira Combinada Automotriz 1170DS * 1175DS * 1630 Arroeira * 3640 Arroeira * 5650 * MF 220A * 220CBD * 220STD * MF 310CBD * 310STD * 210 * 210S * 220 * 310	Eixo Dianteiro / Eje Delantero / Front Axle			







Fersa®			Brand / Marca / Marca	Model / Modelo / Modelo	Application / Aplicação / Aplicaciones
45291 / 45220	TRB		SUDISA	EE4 * EH4	Eixo / Eje / Axle
			DODGE	D350	Eixo Traseiro / Eje Trasero / Rear Axle
				Ram 3500	
				Ram 4000	
			Ram Van * Wagon 3500		
469 / 453	TRB		AGRALE	7500	Eixo Traseiro / Eje Trasero / Rear Axle
			FORD	F-350 Super Duty F-550 Super Duty	
469 / 453 X	TRB		FORD	F-450 * F-450 Super Duty	Eixo Traseiro / Eje Trasero / Rear Axle
47487 / 47420 A	TRB		MERCEDES BENZ	1113 (LPO*OH) * 1114 LPO * 1115 L (OH) * 1118 LPO	Eixo Traseiro / Eje Trasero / Rear Axle
				1313 OH * 1314 OH * 1315 OH * 1316 (OH*OHL) * 1316 G (OH*OHL) * 1317 OH * 1318 OH * 1319 OH * 1320 (OH*OHL)	
1418 OH * 1419 OH * 1420 (OH*OHL) * 1421 OHL					
1517 OH * 1518 OH * 1519 OH * 1520 OH * 1521 OH					
1621 L (OH) * 1623 LG (OH) * 1625 (OH) * 1625 L (OH) * 1628 L (OH) * 1630L (OH) * 1635 (OH) * 1636 L (OH)					
1721 L (OH)					
326 O					
362 O					
364 O					
370 RS*RSD*RST* ST*U*UP (O) * 371 RS*RSD*RST* ST*U*UP (O)					
47487 / 47420 A	TRB		MERCEDES BENZ	1113 (L*LA*LAK*LAS*LK*LP*LS*LP) * 1114 * 1114 (L*LK*LP) * 1116 (L*LA*LAK*LAS*LB* LK*LS) * 1118 (L*LK*LP)	Eixo Traseiro / Eje Trasero / Rear Axle
				1113 OF * 1115 OF	
				1214 C * 1214 K * 1214 (L*LK*LS) * 1215 * 1215 C * 1215 (L*LA*LK) * 1218 * 1218 R (L)	
				1215 OF * 1217 OF	
				1313 (L*LA*LAK*LB*LK*LS) * 1314 (L*LA*LAK*LB*LK*LS) * 1316 (L*LA*LAK*LAS*LB*LK*LS) * 1317 (L*LA*LAK*LK*LS)* 1319 (L)	
				1313 OF * 1314 OF * 1315 OF * 1316 OF * 1317 OF * 1318 OF * 1319 OF * 1320 OF	
				1414 * 1414 (K*L*LA*LAK*LK) * 1418 * 1418 (E*K*R) * 1418 (L*LA*LAK*LK*R(LK)) * 1419 (L*LK*LS) * 1420 (L*LK*LS)	
				1417 OF * 1419 OF * 1421 OF	
				1421 OMC	
				1513 (L*LA*LAK*LB*LG*LK*LS) * 1514 (L*LK*LS) * 1516 (L*LA*LAK*LB*LG*LK*LS) * 1517 (L*LK) * 1518 (L*LK*LS) * 1519 (L*LAK*LB*LG*LK*LS) * 1520 (L*LK*LP*LPK*LPS*LS) * 1521 L * 1524 e 1525 (L*LK*LS)	
				1517 OF * 1518 OF * 1520 OF	
				1614 * 1615 (L*LK*LS) * 1615 * 1618 M * 1618 (L*LK*LS) * 1619 (L)	
				1618 OF	
				1620(L*LK*LS) * 1620 6X2 51 (L) * 1621 (L*LK*LS) * 1622(L*LK*LS) * 1623 (L*LS) * 1625(L*LK*LS) * 1630 (L*LK*LS) * 1632 (L*LS) * 1633(L*LK*LS) * 1634 (L*LS) * 1635 L	
				1620 OF * 1621 OF	
				1714 OF * 1721 OF * 1722 OF	
				1714 * 1714 (L*K*LK) * 1715 * 1718 * 1718 (A * AK) * K * 1720 L * 1721 * 1721 S * 1721 (L*LK) * 1722 S * 1723 * 1723 S * 1725 L	
				1714 * 1714 (L*K*LK) * 1715 * 1718 * 1718 (A * AK) * K * 1720 L * 1721 * 1721 S * 1721 (L*LK) * 1722 S * 1723 * 1723 S * 1725 L	
				1819 (L*LAK*LB*LG*LK*LS) * 1820 LG	
				2013 (L*LA*LAK*LB*LG*LK*LS) * 2013 6X2 (L) * 2014 (L*LB*LK) * 2016 (LB*LK) * 2017 (L*LB*LK)	
2213 (L*LB*LK*LS) * 2213 6X6 (LA) * 2214 * 2215 (L*LB*LK*LS) * 2216 (L*LA*LAK*LB*LG*LK*LS) * 2217 (L*LB*LK*LS) * 2219 (L*LA*LAK*LB*LG*LK*LS) * 2220 * 2222 * 2225 (L*LB*LK*LS)					
47490 / 47420	TRB	References Fersa with Multiple Applications / Referências Fersa com Múltiplas Aplicações / Referencias Fersa con Multiples Aplicaciones			
47686 / 47620	TRB		AGRALE	CHASSI MA 12.0E-TRONIC * MA 12.0SB E-TRONIC * MA 12.0 LE E-TRONIC	Eixo Traseiro / Eje Trasero / Rear Axle
			DINA	434 17570 Shuttle Bus DPX311970	
			MERCEDES BENZ	OH 1417 * OH 1418	











Fersa®			Brand / Marca / Marca	Model / Modelo / Modelo	Application / Aplicação / Aplicaciones
47686 / 47620	TRB		CHRYSLER	D-600 * PD-600	Eixo Traseiro / Eje Trasero / Rear Axle
			DINA	300 HTQ Serie	
				531 K * 532 J	
				551	
				552 Q	
				553 19072 * 555 19070 * 661 25070 * 743 00300	
				604 G1 * 604 G3 * 604 L1 * 604 L5 * 631 K1 * 631 K3 * 661 C1 *	
				661 G1 * 661 G2 * 661 G3	
			DODGE	400 * 450 * 700 * 750 * 900 * 950	
			FAMSA	L1100, L1200, L1300, L1400, L1500, L1600, L2121	
			FORD	Cargo 1113 * 1114 * 1116 * 1117	
				F 11000 * F 12000	
				F 13000 * F 14000 * F 16000	
				F 19000 (77...) * F 21000 * F 22000	
				F 7000 * FT 7000 e FT 8000 (77...80);	
				F 8000 e F 8500 (77...79) * FT 8500	
			FREIGHTLINER	FC 70	
				FL 106	
				FL 70	
				FS 65	
			GENERAL MOTORS	A-C-D 60* 70* 80* 90* 99 Turbo e 3500 Heavy Duty	
				Kodiak	
			MERCEDES BENZ	L1113 * L1114 * L1116 * L1117 * L1118	
				L1214 * L1215 * L1217 39 * L1217 52 * L1218 52	
		L1313 * L1314 * L1315 * L1316 * L1317 * L1318 * L1319 * L1321			
		L1518 52			
		LK1417 34			
		MBO 1018 44			
		MBO 1019 44 Boxer			
		MBO 1217			
		MBO 1219 52 Boxer			
		MBO 1417			
		MBO 1418 60			
		OF 1313 * OF 1314 * OF 1315 * OF 1316 * OF 1317 * OF 1318 51			
		OMC 1418 51 * OMC 1418 60			
		OMC 1419 51			
		LO 1417 59			
		VOLKSWAGEN		OF 1416 * OF 1417 * OF 1418 * OF 1419 * OF 1420 * OF 1421	
			12-140 * 12-140 H * 12-140 T * 12-170 BT		
			13-130 * 13-150 * 13-170 * 13-180E * 13-190 (77...)E * 13-210		
		DINA	451		
			431K * 432K * 432J * 432J1 * 432J2		
			433 16070		
			455 OF		
			500 * 501		
			541 * 542		
			555 OF		
			654 21071		
MERCEDES BENZ	LO 1417 59				
	MBO 1018 44				
	MBO 1019 44 Boxer				
	MBO 1217				
	MBO 1219 52 Boxer				
	MBO 1417				
	MBO 1418 60				
	OF 1313 * OF 1314 * OF 1315 * OF 1316 * OF 1317 * OF 1318 51				
	OF 1416 * OF 1417 * OF 1418 * OF 1419 * OF 1420 * OF 1421				
	OMC 1418 51 * OMC 1418 60				
	OMC 1419 51				



Fersa®			Brand / Marca / Marca	Model / Modelo / Modelo	Application / Aplicação / Aplicaciones
47890 / 47820	TRB		DINA	300 Serie	Eixo Traseiro / Eje Trasero / Rear Axle
				F11 * F12 * F14	
				Marco Polo	
				Viaggio	
			MASA	502 UX	
				Jaguar * Condor * Géminis * Halcón * Strada * Premier 2030F S 5000 * S 5002 * S 2030	
	TRB		DINA	751 Multi Torque	
				861 K	
			FAMSA	DC 10264 Autocar	
			FREIGHTLINER	FLD 120	
				FS 65	
			INTERNATIONAL	4900 DT 466E	
KENWORTH	T2000				
	T 600 Aerocab, B, Modular				
	T800 * Aerocab * Modular * SHW (Short hood wide) * HB * BSH Aerocab * SH 6X4 * 8X4				
	W900 * W924				
482 / 472	TRB		SCANIA	R 112 (81...)	Caixa de Mudanças / Caja de Cambios / Gearbox
				R 142 MA (4X2)(81...)	
				T 142 E (6X4)	
495 A / 493	TRB		DINA	500 Serie	Eixo Traseiro / Eje Trasero / Rear Axle
				400 Serie	
				531 K * 532 J 604 G1 * 604 G3 * 604 L1 * 604 L5 * 631 K1 * 631 K3 * 661 C1 * 661 G1 * 661 G2 * 661 G3	
495 AX / 493	TRB		FORD	F-600 * B-600	Eixo Traseiro / Eje Trasero / Rear Axle
			DINA	400	
496 / 493	TRB		CHRYSLER	D-600 * PD-600	Eixo Traseiro / Eje Trasero / Rear Axle
				300 HTQ Serie	
			DINA	702 * 707	
				761	
FORD	F-600 * B-600				
497 / 492 A	TRB		MERCEDES BENZ	1113 (LPO*OH) * 1114 LPO * 1115 L (OH) * 1118 LPO 1313 OH * 1314 OH * 1315 OH * 1316 (OH*OHL) * 1316 G (OH*OHL) * 1317 OH * 1318 OH * 1319 OH * 1320 (OH*OHL)	Eixo Dianteiro / Eje Delantero / Front Axle
				1517 OH * 1518 OH * 1519 OH * 1520 OH * 1521 OH	Eixo Traseiro / Eje Trasero / Rear Axle
				OH 1113	Eixo Dianteiro / Eje Delantero / Front Axle
				1018 MBO	
				1111 (L*LA*LAK* LAS*LK*LS)	
				1113 (L*LA*LAK*LAS*LK*LP*LS*LP) * 1114 * 1114 (L*LK*LP) * 1116 (L*LA*LAK*LAS*LB* LK*LS) * 1118 (L*LK*LP)	
				1113 OF * 1115 OF	
				1214 C * 1214 K * 1214 (L*LK*LS) * 1215 * 1215 C * 1215 (L*LA*LK) * 1218 * 1218 R (L)	
				1215 OF * 1217 OF	
				1313 (L*LA*LAK*LB*LK*LS) * 1314 (L*LA*LAK*LB*LK*LS) * 1316 (L*LA*LAK*LAS*LB*LK*LS) * 1317 (L*LA*LAK*LK*LS)* 1319 (L)	
				1313 OF * 1314 OF * 1315 OF * 1316 OF * 1317 OF * 1318 OF * 1319 OF * 1320 OF	
	1513 (L*LA*LAK*LB*LG*LK*LS) * 1514 (L*LK*LS) * 1516 (L*LA*LAK*LB*LG*LK*LS) * 1517 (L*LK) * 1518 (L*LK*LS) * 1519 (L*LAK*LB*LG*LK*LS) * 1520 (L*LK*LP*LPK*LPS*LS) * 1521 L * 1524 e 1525 (L*LK*LS)	Eixo Traseiro / Eje Trasero / Rear Axle			
	1517 OF * 1518 OF * 1520 OF				
	1819 (L*LAK*LB*LG*LK*LS) * 1820 LG				
	2013 (L*LA*LAK*LB*LG*LK*LS) * 2013 6X2 (L) * 2014 (L*LB*LK) * 2016 (LB*LK) * 2017 (L*LB*LK)				
	2213 (L*LB*LK*LS) * 2213 6X6 (LA) * 2214 * 2215 (L*LB*LK*LS) * 2216 (L*LA*LAK*LB*LG*LK*LS) * 2217 (L*LB*LK*LS) * 2219 (L*LA*LAK*LB*LG*LK*LS) * 2220 * 2222 * 2225 (L*LB*LK*LS)		Eixo Dianteiro / Eje Delantero / Front Axle		
	TRB		MERCEDES BENZ	1819 (L*LAK*LB*LG*LK*LS) * 1820 LG	Eixo Traseiro / Eje Trasero / Rear Axle
				2013 (L*LA*LAK*LB*LG*LK*LS) * 2013 6X2 (L) * 2014 (L*LB*LK) * 2016 (LB*LK) * 2017 (L*LB*LK)	
				2213 (L*LB*LK*LS) * 2213 6X6 (LA) * 2214 * 2215 (L*LB*LK*LS) * 2216 (L*LA*LAK*LB*LG*LK*LS) * 2217 (L*LB*LK*LS) * 2219 (L*LA*LAK*LB*LG*LK*LS) * 2220 * 2222 * 2225 (L*LB*LK*LS)	
				1819 (L*LAK*LB*LG*LK*LS) * 1820 LG	
				2013 (L*LA*LAK*LB*LG*LK*LS) * 2013 6X2 (L) * 2014 (L*LB*LK) * 2016 (LB*LK) * 2017 (L*LB*LK)	
				2213 (L*LB*LK*LS) * 2213 6X6 (LA) * 2214 * 2215 (L*LB*LK*LS) * 2216 (L*LA*LAK*LB*LG*LK*LS) * 2217 (L*LB*LK*LS) * 2219 (L*LA*LAK*LB*LG*LK*LS) * 2220 * 2222 * 2225 (L*LB*LK*LS)	
1819 (L*LAK*LB*LG*LK*LS) * 1820 LG					
2013 (L*LA*LAK*LB*LG*LK*LS) * 2013 6X2 (L) * 2014 (L*LB*LK) * 2016 (LB*LK) * 2017 (L*LB*LK)					
2213 (L*LB*LK*LS) * 2213 6X6 (LA) * 2214 * 2215 (L*LB*LK*LS) * 2216 (L*LA*LAK*LB*LG*LK*LS) * 2217 (L*LB*LK*LS) * 2219 (L*LA*LAK*LB*LG*LK*LS) * 2220 * 2222 * 2225 (L*LB*LK*LS)					
1819 (L*LAK*LB*LG*LK*LS) * 1820 LG					
2013 (L*LA*LAK*LB*LG*LK*LS) * 2013 6X2 (L) * 2014 (L*LB*LK) * 2016 (LB*LK) * 2017 (L*LB*LK)					





Fersa®			Brand / Marca / Marca	Model / Modelo / Modelo	Application / Aplicação / Aplicaciones
497 / 492 A	TRB		MERCEDES BENZ	LA 1313 * LA 1314 * LA 1315 * LA 1316 * LA 1317 * LA 1318 * LA 1319 * LA 1320 LAK 1313 * LAK 1314 * LAK 1315 * LAK 1316 * LAK 1317 * LAK 1318 * LAK 1320 LAS 1313 * LAS 1314 * LAS 1315 * LAS 1316 * LAS 1317 * LAS 1318 * LAS 1319 * LAS 1320 LB 1314 * LB 1315 * LB 1316 * LB 1317 * LB 1318 * LB 1319 * LB 1320 LK 1313 * LK 1314 * LK 1315 * LK 1316 * LK 1317 * LK 1318 * LK 1319 * LK 1320 * LK 1321 LP 1313 * LP 1314 * LP 1315 * LP 1316 * LP 1317 * LP 1318 * LP 1320 LPO 1313 * LPO 1314 * LPO 1315 * LPO 1316 * LPO 1317 * LPO 1318 * LPO 1320 LS 1314 * LS 1315 * LS 1316 * LS 1317 * LS 1318 * LS 1319 OF 1111 * OF 1113 * OF 1114 * OF 1115 * OF 1116 * OF 1117 * OF 1118 OF 1320	Eixo Dianteiro / Eje Delantero / Front Axle
			MERCEDES BENZ	1018 MBO 1113 OF * 1115 OF 1215 OF * 1217 OF 1313 OF * 1314 OF * 1315 OF * 1316 OF * 1317 OF * 1318 OF * 1319 OF * 1320 OF 1517 OF * 1518 OF * 1520 OF OF 1111 * OF 1113 * OF 1114 * OF 1115 * OF 1116 * OF 1117 * OF 1118 OF 1320	Eixo Traseiro / Eje Trasero / Rear Axle Eixo Dianteiro / Eje Delantero / Front Axle
497 / 493	TRB		DINA	500 Serie	Eixo Traseiro / Eje Trasero / Rear Axle
		FORD	B-800		
		MERCEDES BENZ	OH 1417 * OH 1418		
		SCANIA	110 (B) 110 (L*LS) 111 (L*LS*LT) 140 (LK*LKS)		
		CHRYSLER	D-600 * PD-600 Ram 6500		
		DINA	400 Serie 531 K * 532 J 604 G1 * 604 G3 * 604 L1 * 604 L5 * 631 K1 * 631 K3 * 661 C1 * 661 G1 * 661 G2 * 661 G3 761		
		FAMSA	DC 9964 Autocar F 1314 * F 1317 F 1521 L1100, L1200, L1300, L1400, L1500, L1600, L2121		
		FORD	F-600 * B-600 F-700		
		GENERAL MOTORS	6-100 (4X2)* 6-150* 12-170 L*S (4X2)* 14-190 (77...) (4X2)* 15-190 (77...) (4X2)* 16-220 (4X2) C-3500		
		INTERNATIONAL	4700 4400-215HP 4X2 * 4400-250HP * 4400-285HP * 4400-300HP		
		KENWORTH	T300 4X2 * 6X4		
		MERCEDES BENZ	L1214 * L1215 * L1217 39 * L1217 52 * L1218 52 L1417 52 L1418 39 * L1418 52 * L1418 60 * L1419 59 * L1420. L1422 L1518 52 L1617 59 L1619 52 L1621 52 L2121 54 L2221 LK1417 34 MBO 1217		











Fersa*			Brand / Marca / Marca	Model / Modelo / Modelo	Application / Aplicação / Aplicaciones	
497 / 493	TRB		MERCEDES BENZ	MBO 1417	Eixo Traseiro / Eje Trasero / Rear Axle	
				MBO 1419 60 Boxer		
				MBO 1621		
				OF 1313 * OF 1314 * OF 1315 * OF 1316 * OF 1317 * OF 1318 51		
				OMC 1418 51 * OMC 1418 60		
				OMC 1423 51 Torino		
				OMC 1425 51 Allegro		
498 / 493	TRB		JOHN DEERE	Diversos	Eixo / Eje / Axle	
				JOHN DEERE	Diversos	Eixo / Eje / Axle
498 / 492 A	TRB		MERCEDES BENZ	1517 OH * 1518 OH * 1519 OH * 1520 OH * 1521 OH	Eixo Traseiro / Eje Trasero / Rear Axle	
			MERCEDES BENZ	1513 (L*LA*LAK*LB*LG*LK*LS) * 1514 (L*LK*LS) * 1516 (L*LA*LAK*LB*LG*LK*LS) * 1517 (L*LK) * 1518 (L*LK*LS) * 1519 (L*LAK*LB*LG*LK*LS) * 1520 (L*LK*LP*LPK*LPS*LS) * 1521 L * 1524 e 1525 (L*LK*LS)		
				1517 OF * 1518 OF * 1520 OF		
				1819 (L*LAK*LB*LG*LK*LS) * 1820 LG		
				2013 (L*LA*LAK*LB*LG*LK*LS) * 2013 6X2 (L) * 2014 (L*LB*LK) * 2016 (LB*LK) * 2017 (L*LB*LK)		
				2213 (L*LB*LK*LS) * 2213 6X6 (LA) * 2214 * 2215 (L*LB*LK*LS) * 2216 (L*LA*LAK*LB*LG*LK*LS) * 2217 (L*LB*LK*LS) * 2219 (L*LA*LAK*LB*LG*LK*LS) * 2220 * 2222 * 2225 (L*LB*LK*LS)		
				L 1819 * L 1820 * L 1833		
				LAK 2013 6X2 * LAK 2014 * LAK 2016 * LAK 2017		
				LK 2013 6X2 * LK 2014 * LK 2016 * LK 2017 * LK 2024 * LK 2036 * LK 2042		
				498 A / 493		TRB
CHRYSLER	D-600 * PD-600					
DINA	400 Serie					
FORD	F-600 * B-600					
498 A / 492 A	TRB		FNH	Tratores 4600 * 4610 * 4630 * 5600 * 5610 * 5630 * 6600 * 6610 * 6630 * 7610 * 7630 * 7810 * 7830 * 8030 * 8BR	Câmbio / Caja de Cambios / Gearbox Eixo Dianteiro / Eje Delantero / Front Axle	
52400 / 52618	TRB		VOLVO	Busscar dos y tres ejes C 10 * C 11 C 11R * C 12R	Eixo Traseiro / Eje Trasero / Rear Axle	
			FORD	Cargo 1422 * 1514 * 1517 * 1517E * 1615 * 1615T * 1617 * 1618 * 1618T * 1619 * 1621 * 1622 * 1717E * 1722 * 1722E * 2216 * 2217 * 2218 * 2218T * 2319 * 2322 * 2324 * 2422 * 2422E * 2425 * 2428E * 2630 * 3224 * 3530 * 4030		
			FREIGHTLINER	FL 70		
			KENWORTH	T450, T450 B, T450 W		
53178 / 53377	TRB		VOLVO	B 10M BR B 58 BR (...Chassi 304120)	Eixo Dianteiro / Eje Delantero / Front Axle	
537 / 532 X	TRB		VOLVO	B 10R * B 12B * B 12R * B 58 * B 58BR * B 7R * B9 FH 12 * FH 16 * FH 16	Eixo Dianteiro / Eje Delantero / Front Axle	
55200 C / 55437	TRB		DINA	500 Serie	Eixo Traseiro / Eje Trasero / Rear Axle	
			FORD	B-800		
			MERCEDES BENZ	OH 1417 * OH 1418		
			VOLVO	C 10 * C 11		
			CHRYSLER	D-600 * PD-600		
				Ram 6500		
			DINA	400 Serie		
				531 K * 532 J 604 G1 * 604 G3 * 604 L1 * 604 L5 * 631 K1 * 631 K3 * 661 C1 * 661 G1 * 661 G2 * 661 G3		
			FAMSA	F 1314 * F 1317		
				F 1521 L1100, L1200, L1300, L1400, L1500, L1600, L2121		
			FORD	Cargo 1422 * 1514 * 1517 * 1517E * 1615 * 1615T * 1617 * 1618 * 1618T * 1619 * 1621 * 1622 * 1717E * 1722 * 1722E * 2216 * 2217 * 2218 * 2218T * 2319 * 2322 * 2324 * 2422 * 2422E * 2425 * 2428E * 2630 * 3224 * 3530 * 4030		
				F-600 * B-600		
				F-700		

Fersa®			Brand / Marca / Marca	Model / Modelo / Modelo	Application / Aplicação / Aplicaciones									
55200 C / 55437	TRB		FREIGHTLINER	FL 60 FL 70	Eixo Traseiro / Eje Trasero / Rear Axle									
			GENERAL MOTORS	C-3500										
			INTERNATIONAL	4700 4400-215HP 4X2 * 4400-250HP * 4400-285HP * 4400-300HP										
			KENWORTH	T450, T450 B, T450 W T300 4X2 * 6X4										
				MERCEDES BENZ		L1214 * L1215 * L1217 39 * L1217 52 * L1218 52 L1417 52 L1418 39 * L1418 52 * L1418 60 * L1419 59 * L1420. L1422 L1518 52 L1617 59 L1619 52 L1621 52 L2121 54 LK1417 34 MBO 1017 MBO 1018 44 MBO 1019 44 Boxer MBO 1217 MBO 1417 MBO 1419 60 Boxer MBO 1621 OF 1313 * OF 1314 * OF 1315 * OF 1316 * OF 1317 * OF 1318 51 OMC 1418 51 * OMC 1418 60 OMC 1423 51 Torino LO 1417 59								
			55206 C / 55437			TRB		VOLKSWAGEN	17-210 23-250	Eixo Traseiro / Eje Trasero / Rear Axle				
								VOLVO	C 11R * C 12R					
								CHRYSLER	Ram 6500					
								FORD	LM-700					
								FREIGHTLINER	FC 80 FL 112QR 6X4 FL 70 L-112					
									INTERNATIONAL		4400-215HP 4X2 * 4400-250HP * 4400-285HP * 4400-300HP			
									555 S / 552 A		TRB		FORD	LT-800
								FREIGHTLINER					FL 112 6X4 FL 112QR 6X4	Eixo Traseiro / Eje Trasero / Rear Axle
													INTERNATIONAL	4400-215HP 4X2 * 4400-250HP * 4400-285HP * 4400-300HP
								KENWORTH					T800 * Aerocab * Modular * SHW (Short hood wide) * HB * BSH Aerocab * SH 6X4 * 8X4 W900 * W924	Eixo Dianteiro / Eje Delantero / Front Axle
			MACK			CH Day Cab * CH Premium * CH Select * CH Elite * CX Vision RD688S * RD690								
			STERLING			LT7500 LT9500								
						VOLVO	Autocar / VHD 64B 6X4 NE 64 6X4 * NR 64 T WG 64							
			559 / 552 A	TRB				MERCEDES BENZ	1418 OH * 1419 OH * 1420 (OH*OHL) * 1421 OHL 1517 OH * 1518 OH * 1519 OH * 1520 OH * 1521 OH 352 HL (O) (...74) 355 O 362 O 364 O O 355 OH 1419 * OH 1420 * OH 1421	Eixo Dianteiro / Eje Delantero / Front Axle				









Fersa*			Brand / Marca / Marca	Model / Modelo / Modelo	Application / Aplicação / Aplicaciones					
559 / 552 A			MERCEDES BENZ	1414 * 1414 (K*L*LA*LAK*LK) * 1418 * 1418 (E*K*R) * 1418 (L*LA*LAK*LK*R(LK)) * 1419 (L*LK*LS) * 1420 (L*LK*LS)	Eixo Dianteiro / Eje Delantero / Front Axle					
				1417 OF * 1419 OF * 1421 OF						
				1421 OMC						
				1513 (L*LA*LAK*LB*LG*LK*LS) * 1514 (L*LK*LS) * 1516 (L*LA*LAK*LB*LG*LK*LS) * 1517 (L*LK) * 1518 (L*LK*LS) * 1519 (L*LAK*LB*LG*LK*LS) * 1520 (L*LK*LP*LPK*LPS*LS) * 1521 L * 1524 e 1525 (L*LK*LS)						
				1517 OF * 1518 OF * 1520 OF						
				2013 (L*LA*LAK*LB*LG*LK*LS) * 2013 6X2 (L) * 2014 (L*LB*LK) * 2016 (LB*LK) * 2017 (L*LB*LK)						
				2213 (L*LB*LK*LS) * 2213 6X6 (LA) * 2214 * 2215 (L*LB*LK*LS) * 2216 (L*LA*LAK*LB*LG*LK*LS) * 2217 (L*LB*LK*LS) * 2219 (L*LA*LAK*LB*LG*LK*LS) * 2220 * 2222 * 2225 (L*LB*LK*LS)						
				LK1420 * LK1422						
				LA 1418 * LA 1419 * LA 1420						
				LAK 1418 * LAK 1419 * LAK 1420						
				1417 OF * 1419 OF * 1421 OF						
				1421 OMC						
				1517 OF * 1518 OF * 1520 OF						
				56425 / 56650				DINA	500 Serie	Eixo Traseiro / Eje Trasero / Rear Axle
								FORD	B-800	
								SCANIA	111 (L*LS*LT)	
									140 (LK*LKS)	
								CHRYSLER	D-600 * PD-600	
DINA	400 Serie									
	531 K * 532 J									
	604 G1 * 604 G3 * 604 L1 * 604 L5 * 631 K1 * 631 K3 * 661 C1 * 661 G1 * 661 G2 * 661 G3									
FAMSA	F 1314 * F 1317 F 1521									
FORD	F-600 * B-600 F-700									
GENERAL MOTORS	6-100 (4X2)* 6-150* 12-170 L*S (4X2)* 14-190 (77...) (4X2)* 15-190 (77...) (4X2)* 16-220 (4X2) C-3500									
INTERNATIONAL	4700									
MERCEDES BENZ	L1214 * L1215 * L1217 39 * L1217 52 * L1218 52									
	L1417 52									
	L1418 39 * L1418 52 * L1418 60 * L1419 59 * L1420. L1422									
	L1518 52									
	L1617 59									
	L1619 52									
	L1621 52									
	L2121 54									
	L2221									
	LK1417 34									
	MBO 1217									
	MBO 1417									
MBO 1419 60 Boxer										
MBO 1621										
LO 1417 59										
567 / 563			DINA	500 Serie	Eixo Traseiro / Eje Trasero / Rear Axle					
			DINA	531 K * 532 J						
			DINA	604 G1 * 604 G3 * 604 L1 * 604 L5 * 631 K1 * 631 K3 * 661 C1 * 661 G1 * 661 G2 * 661 G3						
			INTERNATIONAL	4400-215HP 4X2 * 4400-250HP * 4400-285HP * 4400-300HP						
KENWORTH	T300 4X2 * 6X4									
580 / 572			DINA	300 Serie	Eixo Traseiro / Eje Trasero / Rear Axle					
				500 Serie						
				Citus 11000 * 9500						
				D-Avante Plus * D-Dorado						









Fersa®			Brand / Marca / Marca	Model / Modelo / Modelo	Application / Aplicação / Aplicaciones
580 / 572	TRB		DINA	DPC311774 * DPT231770 * DPC311970 * DPT311770 * DPT351970 * DPT352171 * DPT352172 * DPX281770 F11 * F12 * F14 Marco Polo Paradiso * Quadro Viaggio	Eixo Traseiro / Eje Trasero / Rear Axle
			FORD	B-800	
			INTERNATIONAL	3000 RE 4700 FBC * 4700 FE (4X2) * 4700 SCD * 4700 SCD (444 * 466)	
			MASA	502 UX Jaguar * Condor * Géminis * Halcón * Strada * Premier 2030F S 5000 * S 5002 * S 2030 S500T * S500U * S501U Ursus	
			MERCEDES BENZ	1517 OH * 1518 OH * 1519 OH * 1520 OH * 1521 OH OMC 1628 58 Andare	
			MOTOR COACH	F11 * F11A F12 F14 P11 * P12 P14	
			VOLKSWAGEN	17-180 * 17-210 * 17-210 OD * 17-210 EOD * 17-220 * 17-220 Tractor * 17-240 OT * 17-250 Constellation * 17-250 OE * 17-260 EOT * 17-300 * 17-310 TITAN * 17-230 EOD 17-210 22-140 * 22-210 * 23-210 * 23-220 * 23-250 E * 23-310 TITAN	
			VOLVO	Busscar dos y tres ejes C 10 * C 11 C 11R * C 12R U 12 * U 18 Articulado	
			CHRYSLER	Ram 6500	
			DINA	300 HTQ Serie 500 HTQ Serie 551 702 * 707 751 Multi Torque 761 776 861 K 9400 DCE 522570 * DCP 311970 * DCP 311 771 * DCP 351972	
			FAMSA	DC 10264 Autocar	
			FORD	Cargo 1215 Cargo 1313 * 1314 * 1317 * 1317E Cargo 1415 * 1416 Cargo 1422 * 1514 * 1517 * 1517E * 1615 * 1615T * 1617 * 1618 * 1618T * 1619 * 1621 * 1622 * 1717E * 1722 * 1722E * 2216 * 2217 * 2218 * 2218T * 2319 * 2322 * 2324 * 2422 * 2422E * 2425 * 2428E * 2630 * 3224 * 3530 * 4030 F-700 LM-700	
			FREIGHTLINER	Argosy C-120 * Columbia * Coronado * CST 120 FC 80 FL 112QR 6X4 FL 70 FL 80 * FL 80 QR 4X2 FLD 120 FS 65 L-112	



















Fersa®			Brand / Marca / Marca	Model / Modelo / Modelo	Application / Aplicação / Aplicaciones
580 / 572	TRB		GENERAL MOTORS	6-100 (4X2)* 6-150* 12-170 L*S (4X2)* 14-190 (77...) (4X2)* 15-190 (77...) (4X2)* 16-220 (4X2) Kodiak	Eixo Traseiro / Eje Trasero / Rear Axle
			INTERNATIONAL	7400	
				4200 VT 365 * 4300 DT 466 / 195 HP	
				4400-215HP 4X2 * 4400-250HP * 4400-285HP * 4400-300HP	
				4700 (4X2)* 4900 (16 ton.)	
				4900 DT 466E	
				4900-210HP * 4900-215HP * 4900-250HP * 4900-300HP	
				9200 * 9200i * 9400 * 9400i * Day Cab * Day Cab DDC	
			KENWORTH	T2000	
				T300 4X2 * 6X4	
				T 600 Aerocab, B, Modular	
				T300 4X2 * 6X4	
				T800 * Aerocab * Modular * SHW (Short hood wide) * HB * BSH Aerocab * SH 6X4 * 8X4 W900 * W924	
			MACK	CH Day Cab * CH Premium * CH Select * CH Elite * CX Vision	
			MERCEDES BENZ	1513 (L*LA*LAK*LB*LG*LK*LS) * 1514 (L*LK*LS) *	
				1516 (L*LA*LAK*LB*LG*LK*LS) * 1517 (L*LK) * 1518 (L*LK*LS) *	
				1519 (L*LAK*LB*LG*LK*LS) * 1520 (L*LK*LP*LPK*LPS*LS) *	
				1521 L * 1524 e 1525 (L*LK*LS)	
				1517 OF * 1518 OF * 1520 OF	
				331 (L*LPK*LPS) 60...68	
				L1417 52	
				L1518 52	
				L1617 59	
				L1619 52	
				L1621 52	
				L2121 54	
				L2221	
			MBO 1621		
			OMC 1421 51		
			OMC 1425 51 Allegro		
			STERLING	AT 9500	
				L7500	
				LT7500	
				LT9500	
			SUDISA	EA11ED	
		EA12TD			
		VOLKSWAGEN	13-130 * 13-150 * 13-170 * 13-180E * 13-190 (77...)E * 13-210		
			14-140 * 14-150 * 14-170 BT * 14-180 * 14-200 * 14-210 * 14-220		
			15-170 * 15-170E * 15-180 * 15-180E * 15-180 OD * 15-190 (77...) * 15-190 (77...)EOD		
			16-170 * 16-180 * 16-200 * 16-210 * 16-220 CO * 16300		
			18-310 TITAN * 18-310 OT		
			19-320 TITAN Tractor Constellation		
			24-220 * 24-250 * 24-250 Constellation * 24-250E * 26-220 * 26-260E * 26-300		
			31-260E * 35-300 * 40-300		
			Autocar / VHD 64B 6X4		
Autohauler 6X4					
VOLVO	NE 64 6X4 * NR 64 T				
	VM 17 * VM 23 * VM 210				
	VNL 64T * 420 6X4 * 430 * 610 6X4 * 630 * 660 * 670 * 673 * DAY * DAY CAB				
	WG 64				
	311 * 312 * 314 * 362 * 315G * 316G * 317G6 * 318G * 319G * 321C * 323G				
DINA	651 * 653 * 654 * 661 * 741				
	MBO 1621				
MERCEDES BENZ	OMC 1421 51				
	OMC 1425 51 Allegro				
					Eixo / Eje / Axle
					Eixo Traseiro / Eje Trasero / Rear Axle









Fersa®			Brand / Marca / Marca	Model / Modelo / Modelo	Application / Aplicação / Aplicaciones	
580 / 572	TRB		CBT	Tratores 1000 * 1000 (4x4) * 1020 * 1020 (4x4) * 1065 * 1065 (4x4) * 1090 * 1105	Eixo Traseiro / Eje Trasero / Rear Axle	
			JOHN DEERE	Tratores 8060 (4x2) * 8060 (4x4) * 8240 * 8240A * 8260 * 8440 * 8450	Eixo Dianteiro e Traseiro / Eje Delantero y Trasero / Front and Rear Axle	
			NEW HOLLAND	MF50X * MF55X * MF65R * MF65X * MF85 * MF85X * MF95 * MF95X	Eixo / Eje / Axle	
580 / 572 F	TRB		MERCEDES BENZ	1517 OF * 1518 OF * 1520 OF	Eixo Traseiro / Eje Trasero / Rear Axle	
581 / 572	TRB		DINA	761	Eixo Traseiro / Eje Trasero / Rear Axle	
59162 / 59412	TRB		FORD	F 7000 * FT 7000 e FT 8000 (77...80); F 8000 e F 8500 (77...79) * FT 8500	Eixo Traseiro / Eje Trasero / Rear Axle	
59175 / 59412	TRB		FORD	F 100 (61...80 Diesel) * F 600 (56...77 Gas.) * F 700 (77...80) * F 750 (72...77) * 750 * 2000 * 4000	Eixo Traseiro / Eje Trasero / Rear Axle	
				F 11000 * F 12000 F 7000 * FT 7000 e FT 8000 (77...80); F 8000 e F 8500 (77...79) * FT 8500		
594 / 592	TRB		VOLVO	B 58 BR (...Chassi 304120)	Eixo Traseiro / Eje Trasero / Rear Axle	
			VOLVO	FH 12 * FH 16 * FH 16		
594 / 592 A	TRB		VOLKSWAGEN	22-140 * 22-210 * 23-210 * 23-220 * 23-250 E * 23-310 TITAN	Eixo Traseiro / Eje Trasero / Rear Axle	
			VOLVO	B 58 B 58 BR (...Chassi 304120)		
			FIAT	180 C * C3 * L * N * N3 (71...)		
				180 C * C3 * L * N * N3 (71...) FNM D-11000 (58...72)		
			FORD	Cargo 1313 * 1314 * 1317 * 1317E		
				Cargo 1422 * 1514 * 1517 * 1517E * 1615 * 1615T * 1617 * 1618 * 1618T * 1619 * 1621 * 1622 * 1717E * 1722 * 1722E * 2216 * 2217 * 2218 * 2218T * 2319 * 2322 * 2324 * 2422 * 2422E * 2425 * 2428E * 2630 * 3224 * 3530 * 4030 F 13000 * F 14000 * F 16000		
			GENERAL MOTORS	6-100 (4X2) * 6-150 * 12-170 L*S (4X2) * 14-190 (77...) (4X2) * 15-190 (77...) (4X2) * 16-220 (4X2)		
			VOLKSWAGEN	14-140 * 14-150 * 14-170 BT * 14-180 * 14-200 * 14-210 * 14-220		
				16-170 * 16-180 * 16-200 * 16-210 * 16-220 CO * 16300		
			VOLVO	FH 12 * FH 16 * FH 16		
				N * NL 10 BR * N * NL 12 BR * N 10BR Mark II * NL 10BR 6x2		
				NH 12 * FM 12 VM 17 * VM 23 * VM 210		
			FNH	Tratores 4600 * 4610 * 4630 * 5600 * 5610 * 5630 * 6600 * 6610 * 6630 * 7610 * 7630 * 7810 * 7830 * 8030 * 8BR		Tomada de Força / Toma de Fuerza / Power Take-off
594 A / 592 A	TRB		DINA	300 Serie 434 17570 Shuttle Bus 500 Serie Citus 11000 * 9500 D-Avante Plus * D-Dorado DPC311774 * DPT231770 * DPC311970 * DPT311770 * DPT351970 * DPT352171 * DPT352172 * DPX281770 F11 * F12 * F14 Marco Polo Paradiso * Quadro Viaggio	Eixo Traseiro / Eje Trasero / Rear Axle	
				FORD		B-800
				INTERNATIONAL		3000 RE 4700 FBC * 4700 FE (4X2) * 4700 SCD * 4700 SCD (444 * 466)
				MASA		502 UX Jaguar * Condor * Géminis * Halcón * Strada * Premier 2030F S500T * S500U * S501U
						Ursus
						MERCEDES BENZ







APPLICATION BY FERSA REFERENCE
APLICAÇÃO POR REFÊRENCIA FERSA
APLICACIÓN POR REFERENCIA FERSA















Fersa®			Brand / Marca / Marca	Model / Modelo / Modelo	Application / Aplicação / Aplicaciones			
594 A / 592 A	TRB		SUDISA	EA11ED EA12TD	Eixo / Eje / Axle			
			VOLKSWAGEN	15-170 * 15-170E * 15-180 * 15-180E * 15-180 OD * 15-190 (77...) * 15-190 (77...)EOD 18-310 TITAN * 18-310 OT 19-320 TITAN Tractor Constellation 24-220 * 24-250 * 24-250 Constellation * 24-250E * 26-220 * 26-260E * 26-300 31-260E * 35-300 * 40-300	Eixo Traseiro / Eje Trasero / Rear Axle			
				VOLVO		Autocar / VHD 64B 6X4 Autohailer 6X4 NE 64 6X4 * NR 64 T VNL 64T * 420 6X4 * 430 * 610 6X4 * 630 * 660 * 670 * 673 * DAY * DAY CAB WG 64		
						DINA	311 * 312 * 314 * 362 * 315G * 316G * 317G6 * 318G * 319G * 321C * 323G 651 * 653 * 654 * 661 * 741	
							MERCEDES BENZ	MBO 1621 OMC 1421 51 OMC 1425 51 Allegro
						JOHN DEERE		Dirersos
		NEW HOLLAND	MF50X * MF55X * MF65R * MF65X * MF85 * MF85X * MF95 * MF95X					
		598 A / 592 A	TRB		MASA	S 5000 * S 5002 * S 2030	Eixo Traseiro / Eje Trasero / Rear Axle	
					MERCEDES BENZ	OH 1417 * OH 1418		
					DINA	DCE 522570 * DCP 311970 * DCP 311 771 * DCP 351972 702 * 707 761 776 861 K	Direção / Dirección / Steering	
						KENWORTH	T300 4X2 * 6X4	Eixo Traseiro / Eje Trasero / Rear Axle
						MERCEDES BENZ	OF 1313 * OF 1314 * OF 1315 * OF 1316 * OF 1317 * OF 1318 51 OMC 1418 51 * OMC 1418 60 OMC 1423 51 Torino OMC 1425 51 Allegro	
598 A / 593 X	TRB							MERCEDES BENZ
					MERCEDES BENZ	1313 (L*LA*LAK*LB*LK*LS) * 1314 (L*LA*LAK*LB*LK*LS) * 1316 (L*LA*LAK*LAS*LB*LK*LS) * 1317 (L*LA*LAK*LK*LS)* 1319 (L) 1313 OF * 1314 OF * 1315 OF * 1316 OF * 1317 OF * 1318 OF * 1319 OF * 1320 OF 1414 * 1414 (K*L*LA*LAK*LK) * 1418 * 1418 (E*K*R) * 1418 (L*LA*LAK*LK*R(LK)) * 1419 (L*LK*LS) * 1420 (L*LK*LS) 1417 OF * 1419 OF * 1421 OF 1421 OMC 1513 (L*LA*LAK*LB*LG*LK*LS) * 1514 (L*LK*LS) * 1516 (L*LA*LAK*LB*LG*LK*LS) * 1517 (L*LK) * 1518 (L*LK*LS) * 1519 (L*LAK*LB*LG*LK*LS) * 1520 (L*LK*LP*LPK*LPS*LS) * 1521 L * 1524 e 1525 (L*LK*LS) 1517 OF * 1518 OF * 1520 OF 2013 (L*LA*LAK*LB*LG*LK*LS) * 2013 6X2 (L) * 2014 (L*LB*LK) * 2016 (LB*LK) * 2017 (L*LB*LK)		

















Fersa®			Brand / Marca / Marca	Model / Modelo / Modelo	Application / Aplicação / Aplicaciones	
598 A / 593 X	TRB		MERCEDES BENZ	2213 (L*LB*LK*LS) * 2213 6X6 (LA) * 2214 * 2215 (L*LB*LK*LS) * 2216 (L*LA*LAK*LB*LG*LK*LS) * 2217 (L*LB*LK*LS) * 2219 (L*LA*LAK*LB*LG*LK*LS) * 2220 * 2222 * 2225 (L*LB*LK*LS)	Eixo Traseiro / Eje Trasero / Rear Axle	
				LB 1314 * LB 1315 * LB 1316 * LB 1317 * LB 1318 * LB 1319 * LB 1320		
				LG 2013 6X2		
				LG 2213 * LG 2214 * LG 2215 * LG 2216 * LG 2217 * LG 2219 * LG 2220 * LG 2222 * LG 2225		
				LK 1313 * LK 1314 * LK 1315 * LK 1316 * LK 1317 * LK 1318 * LK 1319 * LK 1320 * LK 1321		
				LK 2013 6X2 * LK 2014 * LK 2016 * LK 2017 * LK 2024 * LK 2036 * LK 2042		
				LK 2213 * LK 2214 * LK 2215 * LK 2216 * LK 2217 * LK 2219 * LK 2220 * LK 2222 * LK 2225		
				LS 1314 * LS 1315 * LS 1316 * LS 1317 * LS 1318 * LS 1319		
				LS 2013 * LS 2014 * LS 2016 * LS 2017 * LS 2024 * LS 2036 * LS 2042		
				LS 2213 * LS 2214 * LS 2215 * LS 2216 * LS 2217 * LS 2219		
				1517 OF * 1518 OF * 1520 OF		
				1313 OF * 1314 OF * 1315 OF * 1316 OF * 1317 OF * 1318 OF * 1319 OF * 1320 OF		
				1417 OF * 1419 OF * 1421 OF		
				1421 OMC		
6000 2RS / C3	BB	References Fersa with Multiple Applications / Referências Fersa com Múltiplas Aplicações / Referencias Fersa con Múltiples Aplicaciones				
6001	BB		FORD	Belina I (...78) * Corcel I (...78)	Direção / Dirección / Steering	
				Belina II (79...) * Corcel II (79...)		
				Del Rey * Pampa		
6001 2RS / C3	BB		GENERAL MOTORS	Blazer * Gran Blazer	Motor / Motor / Engine	
6001 C3	BB		VOLKSWAGEN	S 10 (2.2 * 2.4 * 2.5 * 2.8 TD * 4.3)	Direção / Dirección / Steering	
				Passat (1.5 * 1.6 * 1.8)		
6002 2RS / C3	BB	References Fersa with Multiple Applications / Referências Fersa com Múltiplas Aplicações / Referencias Fersa con Múltiples Aplicaciones				
6003 2RS	BB	References Fersa with Multiple Applications / Referências Fersa com Múltiplas Aplicações / Referencias Fersa con Múltiples Aplicaciones				
6003 2RS / C3	BB		FORD	Courier	Motor / Motor / Engine	
				Fiesta		
				Ka		
				Ranger		
			GENERAL MOTORS	Astra		
				Corsa (hatch * pick-up * sedan)		
				Tigra		
				Vectra		
			Zafira (1.8 * 2.0)			
			VOLKSWAGEN	Gol * Parati (AP 1.6 * 1.8 * 2.0)		
				Gol * Parati (motor AT)		
				Passat (1.5 * 1.6 * 1.8)		
				Santana * Santana Quantum (1.6 * 1.8 * 2.0)		
				Saveiro * Voyage		
6004	BB		MERCEDES BENZ	1517 OH * 1518 OH * 1519 OH * 1520 OH * 1521 OH	Motor / Motor / Engine	
				321 H (O) * 321 HL (O) (58...71)		
				326 O		
			SCANIA	P 93 * R 113 * R 143* T 113	Direção / Dirección / Steering	
				MERCEDES BENZ	1513 (L*LA*LAK*LB*LG*LK*LS) * 1514 (L*LK*LS) * 1516 (L*LA*LAK*LB*LG*LK*LS) * 1517 (L*LK) * 1518 (L*LK*LS) * 1519 (L*LAK*LB*LG*LK*LS) * 1520 (L*LK*LP*LPK*LPS*LS) * 1521 L * 1524 e 1525 (L*LK*LS)	Motor / Motor / Engine
					1517 OF * 1518 OF * 1520 OF	
1924 (LS) * 1924 A (LS) * 1929 (L*LK*LS) * 1930 (LS) * 1932 (LS) * 1933 (LS) * 1934 (LS) * 1935 (L*LS) * 1938 * 1938 S * 1938 (L*LS) * 1941 (L*LS) * 1944 S * 1945 (L*LS)						
6004	BB		SCANIA	331 (L*LPK*LPS) 60...68	Caixa de Mudanças / Caja de Cambios / Gearbox	
				112 (F*K*S)	Motor / Motor / Engine	
				F 113 * L 113 * K 113	Direção / Dirección / Steering	
		R 112 (81...)	Motor / Motor / Engine			















Fersa®			Brand / Marca / Marca	Model / Modelo / Modelo	Application / Aplicação / Aplicaciones	
6004	BB		MERCEDES BENZ	1517 OF * 1518 OF * 1520 OF	Motor / Motor / Engine	
			AGRALE	Tratores 4100 * 4200 * 4300 * T145 * T146 * T415 * T420	Câmbio / Caja de Cambios / Gearbox Redução / Reducción / Reduction	
6004 2RS	BB		AGCO MAXION	Colhedeira Combinada Automotriz 1170DS * 1175DS * 1630 Arroeira * 3640 Arroeira * 5650 * MF 220A * 220CBD * 220STD * MF 310CBD * 310STD * 210 * 210S * 220 * 310	Motor / Motor / Engine Plataforma Dianteira / Plataforma Delantera / Front Platform	
			FNH	Colhedeiras 4040 * 5030 * 5050 * 8040 * 8055 * TC55 * TC57 * CA1530	Direção / Dirección / Steering	
6004 2RS / C3	BB	References Fersa with Multiple Applications / Referências Fersa com Múltiplas Aplicações / Referencias Fersa con Multiples Aplicaciones				
6004 Z	BB		MERCEDES BENZ	400 (R * RS * RSD * RSL) (O)	Motor / Motor / Engine	
6004 ZZ / C3	BB	References Fersa with Multiple Applications / Referências Fersa com Múltiplas Aplicações / Referencias Fersa con Multiples Aplicaciones				
6005	BB		VOLVO	B 58	Motor / Motor / Engine	
				B 58 BR (...Chassi 304120)		
6005 2RS	BB		VOLVO	B 10M BR	Embreagem / Embrague / Clutch	
				B 10R * B 12B * B 12R * B 58 * B 58BR * B 7R * B9		
				B 58		
				B 58 BR (...Chassi 304120)		
			VOLVO	N * NL 10 BR * N * NL 12 BR * N 10BR Mark II * NL 10BR 6x2		
6005 2RS / C3	BB		FIAT	Tipo	Motor / Motor / Engine	
6005 ZZ / C3	BB	References Fersa with Multiple Applications / Referências Fersa com Múltiplas Aplicações / Referencias Fersa con Multiples Aplicaciones				
6006	BB		VOLVO	B 10M BR	Direção / Dirección / Steering	
			GURGEL	BR 800	Motor / Motor / Engine	
6006 2RS	BB		VOLVO	FH 12 * FH 16 * FH 16	Embreagem / Embrague / Clutch	
			AGCO MAXION	Colhedeira Combinada Automotriz 1170DS * 1175DS * 1630 Arroeira * 3640 Arroeira * 5650 * MF 220A * 220CBD * 220STD * MF 310CBD * 310STD * 210 * 210S * 220 * 310	Plataforma Dianteira / Plataforma Delantera / Front Platform	
			CITROËN	Xantia (2.0 8V*16V)	Eixo / Eje / Shaft	
				Xsara Picasso (1.6 8V* 1.8 16V * 2.0 8V*16V) ZX (1.6 8V* 1.8 8V* 2.0 8V * 2.0 16V)		
		RENAULT	Traffic (2.1 * 2.2 * 2.5)	Diferencial / Diferencial / Differential Eixo Traseiro / Eje Trasero / Rear Axle		
6006 2RS / C3	BB		PEUGEOT	306	Eixo Dianteiro / Eje Delantero / Front Axle	
6006 RS / C3	BB		PEUGEOT	205	Eixo Dianteiro / Eje Delantero / Front Axle	
6006 ZZ / C3	BB	References Fersa with Multiple Applications / Referências Fersa com Múltiplas Aplicações / Referencias Fersa con Multiples Aplicaciones				
6007	BB		MERCEDES BENZ	1517 OH * 1518 OH * 1519 OH * 1520 OH * 1521 OH	Direção / Dirección / Steering	
				SCANIA		101 (L*LS) * 111 (B) * 111 Articulado (B)
						110 (B)
						110 (L*LS)
						111 (L*LS*LT)
			115 * 116 BR			
			P 93 * R 113 * R 143* T 113	Motor / Motor / Engine		
			VOLVO		B 58	
					B 58 BR (...Chassi 304120)	
			MERCEDES BENZ		1018 MBO	Tomada de Força / Toma de Fuerza / Power Take-off
1111 (L*LA*LAK* LAS*LK*LS)						
1513 (L*LA*LAK*LB*LG*LK*LS) * 1514 (L*LK*LS) * 1516 (L*LA*LAK*LB*LG*LK*LS) * 1517 (L*LK) * 1518 (L*LK*LS) * 1519 (L*LAK*LB*LG*LK*LS) * 1520 (L*LK*LP*LPK*LPS*LS) * 1521 L * 1524 e 1525 (L*LK*LS)						
1517 OF * 1518 OF * 1520 OF						
321 (LAP*LAPK*LAPS*LP* LPK*LPS) 51...71	Direção / Dirección / Steering					
			321 (LAP*LAPK*LAPS*LP* LPK*LPS) 51...71	Tomada de Força / Toma de Fuerza / Power Take-off		





Fersa®			Brand / Marca / Marca	Model / Modelo / Modelo	Application / Aplicação / Aplicaciones
6007	BB		MERCEDES BENZ	321 LAP * LAPK * LAPS * LP * LPK * LPS	Tomada de Potência / Toma de Potencia / Power Take-off
			SCANIA	112 (F*K*S) F 113 * L 113 * K 113 R 112 (81...)	Motor / Motor / Engine
			AGRALE	Tratores 4100 * 4200 * 4300 * T145 * T146 * T415 * T420	Câmbio / Caja de Cambios / Gearbox
		6007 2RS	BB		FNH
6007 2RS / C3	BB	References Fersa with Multiple Applications / Referências Fersa com Múltiplas Aplicações / Referencias Fersa con Multiples Aplicaciones			
6007 C3	BB		SCANIA	101 (L*LS) * 111 (B) * 111 Articulado (B)	Caixa de Mudanças / Caja de Cambios / Gearbox
				110 (B)	
				110 (L*LS)	
				115 * 116 BR	Direção / Dirección / Steering
		140 (LK*LKS)			
			SCANIA	R 142 MA (4X2)(81...) T 142 E (6X4)	Motor / Motor / Engine
6007 N	BB		MERCEDES BENZ	1113 (LPO*OH) * 1114 LPO * 1115 L (OH) * 1118 LPO	Tomada de Força / Toma de Fuerza / Power Take-off
				1313 OH * 1314 OH * 1315 OH * 1316 (OH*OHL) * 1316 G (OH*OHL) * 1317 OH * 1318 OH * 1319 OH * 1320 (OH*OHL)	Tomada de Potência / Toma de Potencia / Power Take-off
				1418 OH * 1419 OH * 1420 (OH*OHL) * 1421 OHL	Tomada de Força / Toma de Fuerza / Power Take-off
				1517 OH * 1518 OH * 1519 OH * 1520 OH * 1521 OH	Tomada de Potência / Toma de Potencia / Power Take-off
				1621 L (OH) * 1623 LG (OH) * 1625 (OH) * 1625 L (OH) * 1628 L (OH) * 1630L (OH) * 1635 (OH) * 1636 L (OH)	Caixa de Mudanças / Caja de Cambios / Gearbox
				1721 L (OH)	Tomada de Força / Toma de Fuerza / Power Take-off
				1721 L (OH)	Caixa de Mudanças / Caja de Cambios / Gearbox
			MERCEDES BENZ	1113 (L*LA*LAK*LAS*LK*LP*LS*LP) * 1114 * 1114 (L*LK*LP) * 1116 (L*LA*LAK*LAS*LB* LK*LS) * 1118 (L*LK*LP)	Tomada de Força / Toma de Fuerza / Power Take-off
				1113 OF * 1115 OF	Tomada de Potência / Toma de Potencia / Power Take-off
				1214 C * 1214 K * 1214 (L*LK*LS) * 1215 * 1215 C * 1215 (L*LA*LK) * 1218 * 1218 R (L)	Tomada de Força / Toma de Fuerza / Power Take-off
				1215 OF * 1217 OF	Tomada de Potência / Toma de Potencia / Power Take-off
				1215 OF * 1217 OF	Tomada de Força / Toma de Fuerza / Power Take-off
				1313 (L*LA*LAK*LB*LK*LS) * 1314 (L*LA*LAK*LB*LK*LS) * 1316 (L*LA*LAK*LAS*LB*LK*LS) * 1317 (L*LA*LAK*LK*LS) * 1319 (L)	Tomada de Potência / Toma de Potencia / Power Take-off
				1313 (L*LA*LAK*LB*LK*LS) * 1314 (L*LA*LAK*LB*LK*LS) * 1316 (L*LA*LAK*LAS*LB*LK*LS) * 1317 (L*LA*LAK*LK*LS) * 1319 (L)	Tomada de Força / Toma de Fuerza / Power Take-off











Fersa®			Brand / Marca / Marca	Model / Modelo / Modelo	Application / Aplicação / Aplicaciones		
6007 N	BB		MERCEDES BENZ	1313 OF * 1314 OF * 1315 OF * 1316 OF * 1317 OF * 1318 OF * 1319 OF * 1320 OF	Tomada de Força / Toma de Fuerza / Power Take-off Tomada de Potência / Toma de Potencia / Power Take-off		
				1414 * 1414 (K*L*LA*LAK*LK) * 1418 * 1418 (E*K*R) * 1418 (L*LA*LAK*LK*R(LK)) * 1419 (L*LK*LS) * 1420 (L*LK*LS)	Tomada de Força / Toma de Fuerza / Power Take-off Tomada de Potência / Toma de Potencia / Power Take-off		
				1417 OF * 1419 OF * 1421 OF	Tomada de Força / Toma de Fuerza / Power Take-off Tomada de Potência / Toma de Potencia / Power Take-off		
				1421 OMC	Tomada de Força / Toma de Fuerza / Power Take-off Tomada de Potência / Toma de Potencia / Power Take-off		
				1513 (L*LA*LAK*LB*LG*LK*LS) * 1514 (L*LK*LS) * 1516 (L*LA*LAK*LB*LG*LK*LS) * 1517 (L*LK) * 1518 (L*LK*LS) * 1519 (L*LAK*LB*LG*LK*LS) * 1520 (L*LK*LP*LPK*LPS*LS) * 1521 L * 1524 e 1525 (L*LK*LS)	Caixa de Mudanças / Caja de Cambios / Gearbox		
				1517 OF * 1518 OF * 1520 OF			
				1614 * 1615 (L*LK*LS) * 1615 * 1618 M * 1618 (L*LK*LS) * 1619 (L)	Tomada de Potência / Toma de Potencia / Power Take-off		
				1618 OF			
				1620(L*LK*LS) * 1620 6X2 51 (L) * 1621 (L*LK*LS) * 1622(L*LK*LS) * 1623 (L*LS) * 1625(L*LK*LS) * 1630 (L*LK*LS) * 1632 (L*LS) * 1633(L*LK*LS) * 1634 (L*LS) * 1635 L	Tomada de Força / Toma de Fuerza / Power Take-off		
				1620 OF * 1621 OF			
				1714 OF * 1721 OF * 1722 OF	Caixa de Mudanças / Caja de Cambios / Gearbox Tomada de Potência / Toma de Potencia / Power Take-off		
				1714 * 1714 (L*K*LK) * 1715 * 1718 * 1718 (A * AK) * K * 1720 L * 1721 * 1721 S * 1721 (L*LK) * 1722 S * 1723 * 1723 S * 1725 L	Caixa de Mudanças / Caja de Cambios / Gearbox Tomada de Potência / Toma de Potencia / Power Take-off		
		2213 (L*LB*LK*LS) * 2213 6X6 (LA) * 2214 * 2215 (L*LB*LK*LS) * 2216 (L*LA*LAK*LB*LG*LK*LS) * 2217 (L*LB*LK*LS) * 2219 (L*LA*LAK*LB*LG*LK*LS) * 2220 * 2222 * 2225 (L*LB*LK*LS)	Tomada de Força / Toma de Fuerza / Power Take-off Tomada de Potência / Toma de Potencia / Power Take-off				
		2314 (L*LB*LK*LS) * 2318 (L*LB*LK*LS) * 2325 (L*LB*LK*LS)	Tomada de Força / Toma de Fuerza / Power Take-off Tomada de Potência / Toma de Potencia / Power Take-off				
			MERCEDES BENZ	1517 OF * 1518 OF * 1520 OF	Caixa de Mudanças / Caja de Cambios / Gearbox		
				1714 OF * 1721 OF * 1722 OF			
			AGRALE	Tratores 4100 * 4200 * 4300 * T145 * T146 * T415 * T420	Tomada de Força / Toma de Fuerza / Power Take-off		
		6008	BB		AGCO MAXION	Tratores MF 235 (4x4) Antigo * MF 235 Moderno* 250 * 265 * MF265 RD * 270 * 274 * 275 * 285 * 290 * MF 292 (4x4) * 295 * 296 * 299	Câmbio / Caja de Cambios / Gearbox
					AGRALE	Tratores 4100 * 4200 * 4300 * T145 * T146 * T415 * T420	Redução / Reducción / Reduction
					CBT	Todos / Todos / All	Tomada de Potência / Toma de Potencia / Power Take-off
FNH	Tratores 4600 * 4610 * 4630 * 5600 * 5610 * 5630 * 6600 * 6610 * 6630 * 7610 * 7630 * 7810 * 7830 * 8030 * 8BR				Transmissão de Força Dupla / Transmisión de Fuerza Doble / Double Transmission		



















Fersa®			Brand / Marca / Marca	Model / Modelo / Modelo	Application / Aplicação / Aplicaciones
6008 2RS	BB		AGCO MAXION	Colheteadeira Combinada Automotriz 1170DS * 1175DS * 1630 Arrozadeira * 3640 Arrozadeira * 5650 * MF 220A * 220CBD * 220STD * MF 310CBD * 310STD * 210 * 210S * 220 * 310	Batedor Traseiro / Bastidor Traseiro / Rear Chassis
				Tratores MF 235 (4x4) Antigo * MF 235 Moderno * 250 * 265 * MF265 RD * 270 * 274 * 275 * 285 * 290 * MF 292 (4x4) * 295 * 296 * 299	Tanque de Grãos / Tanque de Granos / Grain Tank
6008 Z	BB		VALTRA - VALMET	Tratores 60 * 60 ID * 62 * 65 * 65 Cafeeiro * 68 * 68 Cafeeiro * 78 * 80 * M80 * 85 * 85ID * 86 * 86 ID * 88 * 88 ID	Motor / Motor / Engine
				Tratores 360 D * 600 D * 621 ID	
6009	BB		FIAT	130 (76...) 130 OD (78...)	Motor / Motor / Engine
				CBT	
		VALTRA - VALMET		Tratores 110 ID * 110ID II * 118 * 118 (4x4) * 128 * 128 (4x4)	Super - Redução / Super - Reducción / Super - Reduction
6009 2RS	BB		AGCO MAXION	Colheteadeira Combinada Automotriz 1170DS * 1175DS * 1630 Arrozadeira * 3640 Arrozadeira * 5650 * MF 220A * 220CBD * 220STD * MF 310CBD * 310STD * 210 * 210S * 220 * 310	Embreagem / Embrague / Clutch
				Diversos	Tanque de Grãos / Tanque de Granos / Grain Tank
				Tratores MF 235 (4x4) Antigo * MF 235 Moderno * 250 * 265 * MF265 RD * 270 * 274 * 275 * 285 * 290 * MF 292 (4x4) * 295 * 296 * 299	Embreagem / Embrague / Clutch
6009 C3	BB		MERCEDES BENZ	1721 L (OH)	Caixa de Mudanças / Caja de Cambios / Gearbox
			VOLVO	B 58	Conversor de Par / Conversor de Par / Torque Converter
			MERCEDES BENZ	1714 OF * 1721 OF * 1722 OF 1714 * 1714 (L*K*LK) * 1715 * 1718 * 1718 (A * AK) * K * 1720 L * 1721 * 1721 S * 1721 (L*LK) * 1722 S * 1723 * 1723 S * 1725 L	Caixa de Mudanças / Caja de Cambios / Gearbox
				1924 (LS) * 1924 A (LS) * 1929 (L*LK*LS) * 1930 (LS) * 1932 (LS) * 1933 (LS) * 1934 (LS) * 1935 (L*LS) * 1938 * 1938 S * 1938 (L*LS) * 1941 (L*LS) * 1944 S * 1945 (L*LS)	Tomada de Força / Toma de Fuerza / Power Take-off
				2414 (6X4) * 2414 (L) * 2418 (L*LB*LK) * 2420 (L*LB*LK) * 2423 B 6X4 * 2423 K 6X4 * 2425 6X6 (LA) * 2425 (L*LB*LK) * 2428 6X4	Tomada de Potência / Toma de Potencia / Power Take-off
				Axor 2625 * 2628 * 2629 (LK*LS) * 2631 (B*K*L) * 2632 * 2635 (B*K*L) * 2635 (L*LK*LS) * 2635 * 2638 (L*LK*LS) * Axor 2640 * 2641 * 2643 * Axor 2644 * Actos 2646 * 2648 * 2650 * 2651 * 2653 * 2654 (L*LK*LS) * 2657 * 2658 * 2644 * Atego 2628 (B*K) * 2625 * Axor 2826 * Axor 2828 * Axor 2831 2629 LS	Eixo Traseiro / Eje Traseiro / Rear Axle
				2635 (L*LK*LS)	Tomada de Força / Toma de Fuerza / Power Take-off
				VOLVO	N * NL 10 BR * N * NL 12 BR * N 10BR Mark II * NL 10BR 6x2
			MERCEDES BENZ	1714 OF * 1721 OF * 1722 OF	Tomada de Força / Toma de Fuerza / Power Take-off
		6009 NR	BB		AGCO MAXION
6009 ZZ	BB		VOLVO	B 58	Cardan / Cardan / Cardan
				B 58 BR (...Chassi 304120)	
6010	BB		FIAT	130 (76...) 130 OD (78...)	Motor / Motor / Engine
				AGCO MAXION	
		VALTRA - VALMET		Tratores 685 * 685C (4x4) * 785 * 785C (4x4) * 880 Cafeeiro * 880 (4x4) * 885 * 980 (4x4) * 985 * 985F * 1180 * 1184	Câmbio / Caja de Cambios / Gearbox
					Tomada de Potência / Toma de Potencia / Power Take-off













Fersa®			Brand / Marca / Marca	Model / Modelo / Modelo	Application / Aplicação / Aplicaciones
6010 2RS	BB		CBT	Tratores 1000 * 1000 (4x4) * 1020 * 1020 (4x4) * 1065 * 1065 (4x4) * 1090 * 1105	Tomada de Potência / Toma de Potencia / Power Take-off
				Tratores 8060 (4x2) * 8060 (4x4) * 8240 * 8240A * 8260 * 8440 * 8450	Motor / Motor / Engine
6010 C3	BB		VOLVO	B 58 BR (...Chassi 304120)	Conversor de Par / Conversor de Par / Torque Converter
6010 Z	BB		AGCO MAXION	Tratores MF (50X * 55X * 65R * 65X * 85 * 85X * 95 * 95X)	Câmbio / Caja de Cambios / Gearbox
6011	BB		MERCEDES BENZ	1517 OH * 1518 OH * 1519 OH * 1520 OH * 1521 OH	Motor / Motor / Engine
				1517 OH * 1518 OH * 1519 OH * 1520 OH * 1521 OH	
			FIAT	130 OD (78...)	Motor / Motor / Engine
				180 C * C3 * L * N * N3 (71...)	
				FNM D-11000 (58...72)	
				FNM V-15 (69...74)	
			MERCEDES BENZ	1513 (L*LA*LAK*LB*LG*LK*LS) * 1514 (L*LK*LS) * 1516 (L*LA*LAK*LB*LG*LK*LS) * 1517 (L*LK) * 1518 (L*LK*LS) * 1519 (L*LAK*LB*LG*LK*LS) * 1520 (L*LK*LP*LPK*LPS*LS) * 1521 L * 1524 e 1525 (L*LK*LS)	Motor / Motor / Engine
				1517 OF * 1518 OF * 1520 OF	
			AGCO MAXION	Colheteira Combinada Automotriz 1170DS * 1175DS * 1630 Arroeira * 3640 Arroeira * 5650 * MF 220A * 220CBD * 220STD * MF 310CBD * 310STD * 210 * 210S * 220 * 310	Conjunto Saca-palha / Conjunto Saca-Paja / Straw Extractor
				VALTRA - VALMET	
Tratores 1280 * 1284 * 1580 * 1780 * 1780 (4x4) * 1380 * 1680 * 1880 * 118 * 128 * 138 * 148 * 148 (4x4)					
6011 C3	BB		SCANIA	101 (L*LS) * 111 (B) * 111 Articulado (B)	Motor / Motor / Engine
				110 (B)	
				110 (L*LS)	
				111 (L*LS*LT)	
				115 * 116 BR	
				140 (LK*LKS)	
			SCANIA	K 94 IB (4X2)	
				112 (F*K*S)	
				75 * 76 B*L*LS	
				P 94 CB (4x2 * 6x2 * 6X4)	
			P 94 GA*GB (4X2)		
			R 112 (81...)		
			R 142 MA (4X2)(81...)		
			T 142 E (6X4)		
6011 ZZ	BB		AGCO MAXION	Colheteira Combinada Automotriz 1170DS * 1175DS * 1630 Arroeira * 3640 Arroeira * 5650 * MF 220A * 220CBD * 220STD * MF 310CBD * 310STD * 210 * 210S * 220 * 310 Tratores MF 235 (4x4) Antigo * MF 235 Moderno* 250 * 265 * MF265 RD * 270 * 274 * 275 * 285 * 290 * MF 292 (4x4) * 295 * 296 * 299	Tomada de Potência / Toma de Potencia / Power Take-off
6013	BB		AGRALE	Tratores 4100 * 4200 * 4300 * T145 * T146 * T415 * T420	Câmbio / Caja de Cambios / Gearbox
			FNH	Tratores 4600 * 4610 * 4630 * 5600 * 5610 * 5630 * 6600 * 6610 * 6630 * 7610 * 7630 * 7810 * 7830 * 8030 * 8BR	Câmbio / Caja de Cambios / Gearbox
6014	BB		VOLVO	FH 12 * FH 16	Cardan / Cardan / Cardan Eixo Traseiro / Eje Trasero / Rear Axle
6014 2RS	BB		SCANIA	K 113	Embreagem / Embrague / Clutch
				P 93 * R 113 * R 143 * T 113	
			SCANIA	112 (F*K*S)	
				F 113 * L 113 * K 113	
				P 114 GA (4X2) * R 114 GA (4X2 * 6X4) * T 114 GA (4X2) * T 114 LA (6X2)	
R 112 (81...)					









Fersa®			Brand / Marca / Marca	Model / Modelo / Modelo	Application / Aplicação / Aplicaciones					
6014 2RS / C3	BB		SCANIA	K 124 CA (6x4 * 6x2)	Embreagem / Embrague / Clutch					
			SCANIA	P 114 * R 124 * T 114 CB 6x4 * 4x2 * T 124 P 94 CB (4x2 * 6x2 * 6X4)						
			VALTRA - VALMET	Tratores 1280 * 1284 * 1580 * 1780 * 1780 (4x4) * 1380 * 1680 * 1880 * 118 * 128 * 138 * 148* 148 (4x4)	Mancal / Cojinete / Bearing					
				Tratores 870 CN * CK	Embreagem / Embrague / Clutch					
References Fersa with Multiple Applications / Referências Fersa com Múltiplas Aplicações / Referencias Fersa con Multiples Aplicaciones										
6014 C3	BB		MERCEDES BENZ	1819 (L*LAK*LB*LG*LK*LS) * 1820 LG 2213 (L*LB*LK*LS) * 2213 6X6 (LA) * 2214 * 2215 (L*LB*LK*LS) * 2216 (L*LA*LAK*LB*LG*LK*LS) * 2217 (L*LB*LK*LS) * 2219 (L*LA*LAK*LB*LG*LK*LS) * 2220 * 2222 * 2225 (L*LB*LK*LS)	Eixo Traseiro / Eje Trasero / Rear Axle					
						2414 (6X4) * 2414 (L) * 2418 (L*LB*LK) * 2420 (L*LB*LK) * 2423 B 6X4 * 2423 K 6X4 * 2425 6X6 (LA) * 2425 (L*LB*LK) * 2428 6X4				
			VOLVO	FH 12 * FH 16 * FH 16 NH 12 * FM 12	Motor / Motor / Engine					
6015 Z	BB		SCANIA	K 94 IB (4X2)	Caixa de Mudanças / Caja de Cambios / Gearbox					
			SCANIA	75 * 76 B*L*LS P 94 CB (4x2 * 6x2 * 6X4) P 94 GA*GB (4X2) R 112 (81...)						
										
6016 2RS / C3	BB	References Fersa with Multiple Applications / Referências Fersa com Múltiplas Aplicações / Referencias Fersa con Multiples Aplicaciones								
608 2RS / C3	BB	References Fersa with Multiple Applications / Referências Fersa com Múltiplas Aplicações / Referencias Fersa con Multiples Aplicaciones								
6017 NR	BB		FIAT	190 (77...)	Caixa de Mudanças / Caja de Cambios / Gearbox					
6200 2RS	BB		FORD	F 100 (61...80 Diesel) * F 600 (56...77 Gas.) * F 700 (77...80) * F 750 (72...77) * 750 * 2000 * 4000	Motor / Motor / Engine					
6200 2RS / C3	BB		FORD	Belina * Belina II * Corcel * Corcel II Belina I (...78) * Corcel I (...78) Del Rey * Pampa F 75 Jeep Jeep Willys (4X2 * 4X4) (60...83) Rural Rural (4X2 * 4X4) Scala	Motor / Motor / Engine					
				TOYOTA		Bandeirante				
						DODGE	400 * 450 * 700 * 750 * 900 * 950			
				6201		BB		GENERAL MOTORS	Marajó (1.0 * 1.4 * 1.6)	Direção / Dirección / Steering
				6201 2RS		BB	References Fersa with Multiple Applications / Referências Fersa com Múltiplas Aplicações / Referencias Fersa con Multiples Aplicaciones			
				6201 2RS / C3		BB		AGRALE	CHASSI MA 12.0E-TRONIC * MA 12.0SB E-TRONIC * MA 12.0 LE E-TRONIC 1313 OH * 1314 OH * 1315 OH * 1316 (OH*OHL) * 1316 G (OH*OHL) * 1317 OH * 1318 OH * 1319 OH * 1320 (OH*OHL) 1517 OH * 1518 OH * 1519 OH * 1520 OH * 1521 OH	Motor / Motor / Engine
									MERCEDES BENZ	
		SCANIA	111 (L*LS*LT) K 94 IB (4X2)							
VOLKSWAGEN	22-140 * 22-210 * 23-210 * 23-220 * 23-250 E * 23-310 TITAN									
VOLVO	B 58 B 58 BR (...Chassi 304120)									
		AGRALE	9200E-TRONIC Cargo 1215 Cargo 1415 * 1416 F 11000 * F 12000 F 13000 * F 14000 * F 16000 F 19000 (77...) * F 21000 * F 22000							





Fersa®			Brand / Marca / Marca	Model / Modelo / Modelo	Application / Aplicação / Aplicaciones			
6201 2RS / C3	BB		MERCEDES BENZ	1018 MBO 1111 (L*LA*LAK*LAS*LK*LS) 1313 (L*LA*LAK*LB*LK*LS) * 1314 (L*LA*LAK*LB*LK*LS) * 1316 (L*LA*LAK*LAS*LB*LK*LS) * 1317 (L*LA*LAK*LK*LS)* 1319 (L) 1313 OF * 1314 OF * 1315 OF * 1316 OF * 1317 OF * 1318 OF * 1319 OF * 1320 OF 1513 (L*LA*LAK*LB*LG*LK*LS) * 1514 (L*LK*LS) * 1516 (L*LA*LAK*LB*LG*LK*LS) * 1517 (L*LK) * 1518 (L*LK*LS) * 1519 (L*LAK*LB*LG*LK*LS) * 1520 (L*LK*LP*LPK*LPS*LS) * 1521 L * 1524 e 1525 (L*LK*LS) 1517 OF * 1518 OF * 1520 OF 1819 (L*LAK*LB*LG*LK*LS) * 1820 LG 1924 (LS) * 1924 A (LS) * 1929 (L*LK*LS) * 1930 (LS) * 1932 (LS) * 1933 (LS) * 1934 (LS) * 1935 (L*LS) * 1938 * 1938 S * 1938 (L*LS) * 1941 (L*LS) * 1944 S * 1945 (L*LS) 2213 (L*LB*LK*LS) * 2213 6X6 (LA) * 2214 * 2215 (L*LB*LK*LS)* 2216 (L*LA*LAK*LB*LG*LK*LS) * 2217 (L*LB*LK*LS) * 2219 (L*LA*LAK*LB*LG*LK*LS) * 2220 * 2222 * 2225 (L*LB*LK*LS) Axor 2625 * 2628 * 2629 (LK*LS) * 2631 (B*K*L) * 2632 * 2635 (B*K*L) * 2635 (L*LK*LS) * 2635 * 2638 (L*LK*LS) * Axor 2640 * 2641 * 2643 * Axor 2644 * Actos 2646 * 2648 * 2650 * 2651 * 2653 * 2654 (L*LK*LS) * 2657 * 2658 * 2644 * Atego 2628 (B*K) * 2625 * Axor 2826 * Axor 2828 * Axor 2831 2629 LS 2635 (L*LK*LS)	Motor / Motor / Engine			
				SCANIA		P 94 CB (4x2 * 6x2 * 6X4) P 94 GA*GB (4X2)		
				VOLKSWAGEN		11-130 * 11-140 * 11-160 12-140 * 12-140 H * 12-140 T * 12-170 BT 13-130 * 13-150 * 13-170 * 13-180E * 13-190 (77...)E * 13-210 14-140 * 14-150 * 14-170 BT * 14-180 * 14-200 * 14-210 * 14-220 15-170 * 15-170E * 15-180 * 15-180E * 15-180 OD * 15-190 (77...) * 15-190 (77...)EOD 16-170 * 16-180 * 16-200 * 16-210 * 16-220 CO * 16300		
				VOLVO		N * NL 10 BR * N * NL 12 BR * N 10BR Mark II * NL 10BR 6x2		
						MERCEDES BENZ	1018 MBO 1313 OF * 1314 OF * 1315 OF * 1316 OF * 1317 OF * 1318 OF * 1319 OF * 1320 OF 1517 OF * 1518 OF * 1520 OF	
						FIAT	147 Elba Fiorino Idea Oggi Panorama Pick-up Prêmio Spazio Uno	
				FORD			Escort F 75 Jeep Jeep Willys (4X2 * 4X4) (60...83) Royale Rural Rural (4X2 * 4X4) Verona Versailles	
							GENERAL MOTORS	Blazer * Gran Blazer Corsa (hatch * pick-up * sedan) Ipanema* Kadett * Monza (1.8 * 2.0) Monza * Kadett * Ipanema





Fersa®			Brand / Marca / Marca	Model / Modelo / Modelo	Application / Aplicação / Aplicaciones		
6201 2RS / C3	BB		GENERAL MOTORS	Omega * Suprema	Motor / Motor / Engine		
				Silverado			
				Tigra			
			LADA	1600			
				Laika (1.6)			
				Niva			
				Samara			
			MBB	180 D			
			MERCEDES BENZ	MB 180			
			PEUGEOT	205			
			VOLKSWAGEN	Apollo			
				Brasília (1500 * 1600)* Fusca (1300 * 1300L* 1500 * 1600)* Variant I			
				Gol * Parati (AP 1.6 * 1.8 * 2.0)			
				Gol * Parati (motor AT)			
		Gol * Parati (motor CHT)					
		Gol (1.3 * 1.6)					
		Gol * Parati * Voyage * Saveiro					
		Kombi (1500 * 1600)					
		Logus					
		Logus (1.6 * 1.8)					
		Passat					
		Passat (1.5 * 1.6 * 1.8)					
		Pointer (1.8 * 2.0)					
		Santana * Santana Quantum (1.6 * 1.8 * 2.0)					
		Saveiro * Voyage					
		Variant					
Variant II							
	CBT	2070 * 2080 * 2100 * 2105 (4x2) * 2400 * 2400 (4x4) * 2500 * 2600					
		Tratores 1000 * 1000 (4x4) * 1020 * 1020 (4x4) * 1065 * 1065 (4x4) * 1090 * 1105					
	VALTRA - VALMET	Tratores 60 * 60 ID * 62 * 65 * 65 Cafeeiro * 68 * 68 Cafeeiro * 78 * 80 * M80 * 85 * 85ID * 86 * 86 ID * 88 * 88 ID					
		Tratores 110 ID * 110ID II * 118 * 118 (4x4) * 128 * 128 (4x4)					
		Tratores 1280 * 1284 * 1580 * 1780 * 1780 (4x4) * 1380 * 1680 * 1880 * 118 * 128 * 138 * 148* 148 (4x4)					
		Tratores 685 * 685C (4x4) * 785 * 785C (4x4) * 880 Cafeeiro * 880 (4x4) * 885 * 980 (4x4) * 985 * 985F * 1180 * 1184					
		Tratores 870 CN * CK					
		6201 N 2RS / C3	BB		GENERAL MOTORS	Omega * Omega Suprema (2.0 * 2.2 * 3.0 * 4.1) S 10 (2.2 * 2.4 * 2.5 * 2.8 TD * 4.3)	Motor / Motor / Engine
		6201 RS / C3	BB		MERCEDES BENZ	1517 OH * 1518 OH * 1519 OH * 1520 OH * 1521 OH 1513 (L*LA*LAK*LB*LG*LK*LS) * 1514 (L*LK*LS) * 1516 (L*LA*LAK*LB*LG*LK*LS) * 1517 (L*LK) * 1518 (L*LK*LS) * 1519 (L*LAK*LB*LG*LK*LS) * 1520 (L*LK*LP*LPK*LPS*LS) * 1521 L * 1524 e 1525 (L*LK*LS)	Motor / Motor / Engine
					MERCEDES BENZ	1517 OF * 1518 OF * 1520 OF	
					MERCEDES BENZ	1517 OF * 1518 OF * 1520 OF	
		6201 Z	BB		AGRALE	Tratores 4100 * 4200 * 4300 * T145 * T146 * T415 * T420	Motor / Motor / Engine
6201 Z / C3	BB		MERCEDES BENZ	1113 (LPO*OH) * 1114 LPO * 1115 L (OH) * 1118 LPO 101 (L*LS) * 111 (B) * 111 Articulado (B)	Motor / Motor / Engine		
				110 (B)			
			SCANIA	110 (L*LS)			
				115 * 116 BR			
				140 (LK*LKS)			
			VOLVO	B 10M BR			
				B 10R * B 12B * B 12R * B 58 * B 58BR * B 7R *B9			
				B 58			
			B 58 BR (...Chassi 304120)				
			MERCEDES BENZ	1113 (L*LA*LAK*LAS*LK*LP*LS*LP) * 1114 * 1114 (L*LK*LP) * 1116 (L*LA*LAK*LAS*LB* LK*LS) * 1118 (L*LK*LP) 1113 OF * 1115 OF			







Fersa®			Brand / Marca / Marca	Model / Modelo / Modelo	Application / Aplicação / Aplicaciones		
6201 Z / C3	BB		SCANIA	75 * 76 B*L*LS R 142 MA (4X2)(81...) T 142 E (6X4)	Motor / Motor / Engine		
			VOLVO	N * NL 10 BR * N * NL 12 BR * N 10BR Mark II * NL 10BR 6x2			
			MERCEDES BENZ	1113 OF * 1115 OF			
6201 ZZ	BB		SCANIA	101 (L*LS) * 111 (B) * 111 Articulado (B) 110 (L*LS) K 94 IB (4X2)	Embreagem / Embrague / Clutch		
			FIAT	FNM 210 C * CM * LN (71...76)	Motor / Motor / Engine		
			SCANIA	75 * 76 B*L*LS P 94 CB (4x2 * 6x2 * 6X4) P 94 GA*GB (4X2)	Embreagem / Embrague / Clutch		
				VALTRA - VALMET	Tratores 360 D * 600 D * 621 ID	Motor / Motor / Engine	
6201 ZZ / C3	BB		VOLVO	B 10M BR B 10R * B 12B * B 12R * B 58 * B 58BR * B 7R *B9 B 58 B 58 BR (...Chassi 304120)	Motor / Motor / Engine		
				MERCEDES BENZ		2013 (L*LA*LAK*LB*LG*LK*LS) * 2013 6X2 (L) * 2014 (L*LB*LK) * 2016 (LB*LK) * 2017 (L*LB*LK)	
						VOLKSWAGEN	Gol * Parati * Voyage * Saveiro Kombi Passat Variant
			References Fersa with Multiple Applications / Referências Fersa com Múltiplas Aplicações / Referencias Fersa con Multiples Aplicaciones				
		6202	BB		CBT	2070 * 2080 * 2100 * 2105 (4x2) * 2400 * 2400 (4x4) * 2500 * 2600 Tratores 1000 * 1000 (4x4) * 1020 * 1020 (4x4) * 1065 * 1065 (4x4) * 1090 * 1105	Motor / Motor / Engine
					FNH	Colheitadeiras 4040 * 5030 * 5050 * 8040 * 8055 * TC55 * TC57 * CA1530	Picador de Palha / Picador de Paja / Straw Chopper Sistema Pneumático / Sistema Neumático / Neumatic System
	FORD			F 75 Jeep Willys (4X2 * 4X4) (60...83) Rural Rural (4X2 * 4X4)	Motor / Motor / Engine		
6202 2RS	BB		VOLVO	B 58 B 58 BR (...Chassi 304120)	Motor / Motor / Engine		
				FIAT	FNM V-15 (69...74) N * NL 10 BR * N * NL 12 BR * N 10BR Mark II * NL 10BR 6x2	Embreagem / Embrague / Clutch Motor / Motor / Engine	
				AGCO MAXION	Colheitadeira Combinada Automotriz 1170DS * 1175DS * 1630 Arroeira * 3640 Arroeira * 5650 * MF 220A * 220CBD * 220STD * MF 310CBD * 310STD * 210 * 210S * 220 * 310	Batedor Traseiro / Bastidor Trasero / Rear Chassis Plataforma Dianteira / Plataforma Delantera / Front Platform	
			FNH	Colheitadeiras 4040 * 5030 * 5050 * 8040 * 8055 * TC55 * TC57 * CA1530	Batedor / Bastidor / Chassis Tomada de Ar / Entrada de Aire / Air inlet		
			TOYOTA	Bandeirante	Motor / Motor / Engine		
			VOLKSWAGEN	Gol * Parati * Voyage * Saveiro Kombi Passat Variant			
6202 2RS / C3	BB		SCANIA	111 (L*LS*LT) K 94 IB (4X2)	Motor / Motor / Engine		
				SCANIA		P 94 CB (4x2 * 6x2 * 6X4) P 94 GA*GB (4X2)	
				FORD		Belina * Belina II * Corcel * Corcel II Del Rey * Pampa	
			GENERAL MOTORS	Corsa (hatch * pick-up * sedan)			
		RENAULT	R 24				





Fersa®			Brand / Marca / Marca	Model / Modelo / Modelo	Application / Aplicação / Aplicaciones		
6202 2RS / C3	BB		RENAULT	Traffic (2.1 * 2.2 * 2.5)	Motor / Motor / Engine		
			TOYOTA	Bandeirante			
			VOLKSWAGEN	Brasília			
				Brasília (1500 * 1600)* Fusca (1300 * 1300L* 1500 * 1600)* Variant I			
				Gol (1.3 * 1.6)			
				Gol * Parati * Voyage * Saveiro			
				Kombi			
				Kombi (1500 * 1600)			
				Variant			
Variant II							
6202 C3	BB		FORD	Jeep	Motor / Motor / Engine		
6202 Z	BB		AGRALE	Tratores 4100 * 4200 * 4300 * T145 * T146 * T415 * T420	Motor / Motor / Engine		
			CBT	Tratores 1000 * 1000 (4x4) * 1020 * 1020 (4x4) * 1065 * 1065 (4x4) * 1090 * 1105			
6202 Z / C3	BB		SCANIA	101 (L*LS) * 111 (B) * 111 Articulado (B)	Motor / Motor / Engine		
				110 (B)			
				110 (L*LS)			
				115 * 116 BR			
		140 (LK*LKS)					
			SCANIA	75 * 76 B*L*LS			
R 142 MA (4X2)(81...)							
T 142 E (6X4)							
6202 ZZ	BB		FIAT	180 C * C3 * L* N * N3 (71...)	Motor / Motor / Engine		
				FNM 210 C * CM * LN (71...76)			
				FNM D-11000 (58...72)			
			FHN	Tratores 4600 * 4610 * 4630 * 5600 * 5610 * 5630 * 6600 * 6610 * 6630 * 7610 * 7630 * 7810 * 7830 * 8030 * 8BR			
				VALTRA - VALMET		Tratores 360 D * 600 D * 621 ID	
						TOYOTA	Bandeirante
VOLKSWAGEN	Fusca	Motor / Motor / Engine					
	Gol * Parati * Voyage * Saveiro						
	Kombi						
Variant	Variant	Variant					
		6202 ZZ / C3	BB		FORD	Belina * Belina II * Corcel * Corcel II	Motor / Motor / Engine
						Del Rey * Pampa	
6203	BB		MERCEDES BENZ	1418 OH * 1419 OH * 1420 (OH*OHL) * 1421 OHL	Motor / Motor / Engine		
				352 HL (O) (...74)			
				355 O			
				362 O			
				364 O			
				364 HL (O) (...74)			
				608 D * E (L*LO) * 708 D * E (L*LO) * 709 L * 710 L * 712 L			
				812 LO * 912 L			
			FORD	Cargo 1113 * 1114 * 1116 * 1117	Motor / Motor / Engine		
				Cargo 1215			
				Cargo 1313 * 1314 * 1317 * 1317E			
				Cargo 1415 * 1416			
				Cargo 1422 * 1514 * 1517 * 1517E * 1615 * 1615T * 1617 * 1618 * 1618T * 1619 * 1621 * 1622 * 1717E * 1722 * 1722E * 2216 * 2217 * 2218 * 2218T * 2319 * 2322 * 2324 * 2422 * 2422E * 2425 * 2428E * 2630 * 3224 * 3530 * 4030			
				608 (L*LO) * 708 (L*LO) * 809 (LO*OF) * 812 (LO*OF) * 814 LO * 817 O * 914 LO * 709 * 710 * 712 * 712 C * 811 * 911 L * 912 * 913 * 914 * 914 C * 917			
				1018 MBO			
MERCEDES BENZ	1111 (L*LA*LAK* LAS*LK*LS)						
	1414 * 1414 (K*L*LA*LAK*LK) * 1418 * 1418 (E*K*R) * 1418 (L*LA*LAK*LK*R(LK)) * 1419 (L*LK*LS) * 1420 (L*LK*LS)						
	1417 OF * 1419 OF * 1421 OF						
	1421 OMC						







Fersa®			Brand / Marca / Marca	Model / Modelo / Modelo	Application / Aplicação / Aplicaciones			
6203	BB		MERCEDES BENZ	2213 (L*LB*LK*LS) * 2213 6X6 (LA) * 2214 * 2215 (L*LB*LK*LS) * 2216 (L*LA*LAK*LB*LG*LK*LS) * 2217 (L*LB*LK*LS) * 2219 (L*LA*LAK*LB*LG*LK*LS) * 2220 * 2222 * 2225 (L*LB*LK*LS)	Motor / Motor / Engine			
		VOLKSWAGEN	11-130 * 11-140 * 11-160 12-140 * 12-140 H * 12-140 T * 12-170 BT					
			MERCEDES BENZ	1018 MBO 1417 OF * 1419 OF * 1421 OF 1421 OMC				
			CBT	2070 * 2080 * 2100 * 2105 (4x2) * 2400 * 2400 (4x4) * 2500 * 2600 Tratores 1000 * 1000 (4x4) * 1020 * 1020 (4x4) * 1065 * 1065 (4x4) * 1090 * 1105				
		VALTRA - VALMET	Tratores 60 * 60 ID * 62 * 65 * 65 Cafeeiro * 68 * 68 Cafeeiro * 78 * 80 * M80 * 85 * 85ID * 86 * 86 ID * 88 * 88 ID Tratores 110 ID * 110ID II * 118 * 118 (4x4) * 128 * 128 (4x4)					
			TOYOTA	Bandeirante				
		6203 2RS / C3	BB			AGRALE	9200E-TRONIC	Motor / Motor / Engine
				FORD		Cargo 1215 Cargo 1415 * 1416 F 100 (61...80 Diesel) * F 600 (56...77 Gas.) * F 700 (77...80) * F 750 (72...77) * 750 * 2000 * 4000 F 11000 * F 12000 F 13000 * F 14000 * F 16000 F 19000 (77...) * F 21000 * F 22000		
				MERCEDES BENZ		1924 (LS) * 1924 A (LS) * 1929 (L*LK*LS) * 1930 (LS) * 1932 (LS) * 1933 (LS) * 1934 (LS) * 1935 (L*LS) * 1938 * 1938 S * 1938 (L*LS) * 1941 (L*LS) * 1944 S * 1945 (L*LS)		
						ALFA ROMEO	Alfa 2300	
FIAT	147 Elba Fiorino Idea Oggi Panorama Pick-up Prêmio Spazio Uno							
FORD	Belina * Belina II * Corcel * Corcel II Belina I (...78) * Corcel I (...78) Belina II (79...) * Corcel II (79...) Courier Del Rey * Pampa Escort F 100 F 1000 (79...) F 2000 F 2000 (80...) F 350 F 400 F 4000 F 4000 (75...) F 75 Fiesta Jeep Jeep Willys (4X2 * 4X4) (60...83) Ka Ranger Royale Rural Rural (4X2 * 4X4)							









Fersa®			Brand / Marca / Marca	Model / Modelo / Modelo	Application / Aplicação / Aplicaciones	
6203 2RS / C3	BB		FORD	Scala	Motor / Motor / Engine	
				Sierra (L * XR3 * S)		
				Verona		
				Versailles		
			GENERAL MOTORS	Astra		
				Blazer * Gran Blazer		
				Caravan * Opala		
				Chevette * Chevette Junior * Chevy 500 * Marajó		
				Corsa (hatch * pick-up * sedan)		
				Ipanema * Kadett * Monza (1.8 * 2.0)		
				Marajó (1.0 * 1.4 * 1.6)		
				Monza * Kadett * Ipanema		
				Omega * Omega Suprema (2.0 * 2.2 * 3.0 * 4.1)		
				S 10 (2.2 * 2.4 * 2.5 * 2.8 TD * 4.3)		
				Silverado		
				Tigra		
				Vectra		
			Zafira (1.8 * 2.0)			
			RENAULT	Laguna (2.0)		
				R 23		
				Traffic (2.1 * 2.2 * 2.5)		
			TOYOTA	Bandeirante		
			VOLKSWAGEN	Apollo		
				Bora		
				Brasília		
				Brasília (1500 * 1600) * Fusca (1300 * 1300L * 1500 * 1600) * Variant I		
				Gol * Parati (AP 1.6 * 1.8 * 2.0)		
				Gol * Parati (motor AT)		
				Gol * Parati (motor CHT)		
				Gol (1.3 * 1.6)		
				Gol * Parati * Voyage * Saveiro		
				Kombi		
				Kombi (1500 * 1600)		
Passat						
Passat (1.5 * 1.6 * 1.8)						
Santana * Santana Quantum (1.6 * 1.8 * 2.0)						
Saveiro * Voyage						
Variant						
Variant II						
6203 C3	BB		MERCEDES BENZ	1113 OF * 1115 OF	Motor / Motor / Engine	
				1215 OF * 1217 OF		
				1313 OF * 1314 OF * 1315 OF * 1316 OF * 1317 OF * 1318 OF * 1319 OF * 1320 OF		
				1417 OF * 1419 OF * 1421 OF		
				1421 OMC		
				1517 OF * 1518 OF * 1520 OF		
				1618 OF		
				1620 OF * 1621 OF		
				1714 OF * 1721 OF * 1722 OF		
						
		Elevador de Grãos / Elevador de Granos / Grain Elevator				
		Limpeza / Limpieza / Cleaning				
		Plataforma Dianteira / Plataforma Delantera / Front Platform				
		Canal Elevador de grãos / Canal Elevador de Granos / Grain Elevator Channel				
				Tratores MF 235 (4x4) Antigo * MF 235 Moderno* 250 * 265 * MF265 RD * 270 * 274 * 275 * 285 * 290 * MF 292 (4x4) * 295 * 296 * 299		







Fersa®			Brand / Marca / Marca	Model / Modelo / Modelo	Application / Aplicação / Aplicaciones			
6203 C3	BB		FNH	Colheitadeiras 4040 * 5030 * 5050 * 8040 * 8055 * TC55 * TC57 * CA1530	Direção / Dirección / Steering Embreagem / Embrague / Clutch Picador de Palha / Picador de Paja / Straw Chopper Tomada de Ar / Entrada de Aire / Air inlet			
				ALFA ROMEO	Alfa 2300	Motor / Motor / Engine		
				RENAULT	Traffic (2.1 * 2.2 * 2.5)	Embreagem / Embrague / Clutch		
					MERCEDES BENZ	1113 (LPO*OH) * 1114 LPO * 1115 L (OH) * 1118 LPO 1313 OH * 1314 OH * 1315 OH * 1316 (OH*OHL) * 1316 G (OH*OHL) * 1317 OH * 1318 OH * 1319 OH * 1320 (OH*OHL) 1418 OH * 1419 OH * 1420 (OH*OHL) * 1421 OHL 1517 OH * 1518 OH * 1519 OH * 1520 OH * 1521 OH 1621 L (OH) * 1623 LG (OH) * 1625 (OH) * 1625 L (OH) * 1628 L (OH) * 1630L (OH) * 1635 (OH) * 1636 L (OH) 1721 L (OH) 370 RS*RSD*RST* ST*U*UP (O) * 371 RS*RSD*RST* ST*U*UP (O)	Motor / Motor / Engine	
		FORD	Cargo 814			Embreagem / Embrague / Clutch		
			Cargo 815 * 815 E					
		GENERAL MOTORS	A-C-D 60* 70* 80* 90* 99 Turbo e 3500 Heavy Duty			Motor / Motor / Engine		
			MERCEDES BENZ			1113 (L*LA*LAK*LAS*LK*LP*LS*LP) * 1114 * 1114 (L*LK*LP) * 1116 (L*LA*LAK*LAS*LB*LK*LS) * 1118 (L*LK*LP) 1113 OF * 1115 OF 1214 C * 1214 K * 1214 (L*LK*LS) * 1215 * 1215 C * 1215 (L*LA*LK) * 1218 * 1218 R (L) 1215 OF * 1217 OF 1313 (L*LA*LAK*LB*LK*LS) * 1314 (L*LA*LAK*LB*LK*LS) * 1316 (L*LA*LAK*LAS*LB*LK*LS) * 1317 (L*LA*LAK*LK*LS)* 1319 (L) 1313 OF * 1314 OF * 1315 OF * 1316 OF * 1317 OF * 1318 OF * 1319 OF * 1320 OF 1414 * 1414 (K*L*LA*LAK*LK) * 1418 * 1418 (E*K*R) * 1418 (L*LA*LAK*LK*R(LK)) * 1419 (L*LK*LS) * 1420 (L*LK*LS) 1417 OF * 1419 OF * 1421 OF 1421 OMC 1513 (L*LA*LAK*LB*LG*LK*LS) * 1514 (L*LK*LS) * 1516 (L*LA*LAK*LB*LG*LK*LS) * 1517 (L*LK) * 1518 (L*LK*LS) * 1519 (L*LAK*LB*LG*LK*LS) * 1520 (L*LK*LP*LPK*LPS*LS) * 1521 L * 1524 e 1525 (L*LK*LS) 1517 OF * 1518 OF * 1520 OF 1614 * 1615 (L*LK*LS) * 1615 * 1618 M * 1618 (L*LK*LS) * 1619 (L) 1618 OF 1620(L*LK*LS) * 1620 6X2 51 (L) * 1621 (L*LK*LS) * 1622(L*LK*LS) * 1623 (L*LS) * 1625(L*LK*LS) * 1630 (L*LK*LS) * 1632 (L*LS) * 1633(L*LK*LS) * 1634 (L*LS) * 1635 L 1620 OF * 1621 OF 1714 OF * 1721 OF * 1722 OF 1714 * 1714 (L*K*LK) * 1715 * 1718 * 1718 (A * AK) * K * 1720 L * 1721 * 1721 S * 1721 (L*LK) * 1722 S * 1723 * 1723 S * 1725 L 2013 (L*LA*LAK*LB*LG*LK*LS) * 2013 6X2 (L) * 2014 (L*LB*LK) * 2016 (LB*LK) * 2017 (L*LB*LK) 2213 (L*LB*LK*LS) * 2213 6X6 (LA) * 2214 * 2215 (L*LB*LK*LS) * 2216 (L*LA*LAK*LB*LG*LK*LS) * 2217 (L*LB*LK*LS) * 2219 (L*LA*LAK*LB*LG*LK*LS) * 2220 * 2222 * 2225 (L*LB*LK*LS) 2314 (L*LB*LK*LS) * 2318 (L*LB*LK*LS) * 2325 (L*LB*LK*LS) 2414 (6X4) * 2414 (L) * 2418 (L*LB*LK) * 2420 (L*LB*LK) * 2423 B 6X4 * 2423 K 6X4 * 2425 6X6 (LA) * 2425 (L*LB*LK) * 2428 6X4	Motor / Motor / Engine	
						AGCO MAXION	Colheitadeira Combinada Automotriz 1170DS * 1175DS * 1630 Arroeira * 3640 Arroeira * 5650 * MF 220A * 220CBD * 220STD * MF 310CBD * 310STD * 210 * 210S * 220 * 310	Motor / Motor / Engine
							FNH	Tratores 4600 * 4610 * 4630 * 5600 * 5610 * 5630 * 6600 * 6610 * 6630 * 7610 * 7630 * 7810 * 7830 * 8030 * 8BR







Fersa®			Brand / Marca / Marca	Model / Modelo / Modelo	Application / Aplicação / Aplicaciones		
6203 ZZ	BB		FIAT	180 C * C3 * L * N * N3 (71...) FNM D-11000 (58...72)	Motor / Motor / Engine		
			FORD	F 100 (61...80 Diesel) * F 600 (56...77 Gas.) * F 700 (77...80) * F 750 (72...77) * 750 * 2000 * 4000	Embreagem / Embrague / Clutch		
			AGCO MAXION	Tratores MF 235 (4x4) Antigo * MF 235 Moderno* 250 * 265 * MF265 RD * 270 * 274 * 275 * 285 * 290 * MF 292 (4x4) * 295 * 296 * 299	Motor / Motor / Engine		
				Tratores MF (50X * 55X * 65R * 65X * 85 * 85X * 95 * 95X)	Câmbio / Caja de Cambios / Gearbox Embreagem / Embrague / Clutch		
			CBT	Tratores 8060 (4x2) * 8060 (4x4) * 8240 * 8240A * 8260 * 8440 * 8450	Motor / Motor / Engine		
			FNH	Tratores 4600 * 4610 * 4630 * 5600 * 5610 * 5630 * 6600 * 6610 * 6630 * 7610 * 7630 * 7810 * 7830 * 8030 * 8BR			
		VALTRA - VALMET	Tratores 60 * 60 ID * 62 * 65 * 65 Cafeeiro * 68 * 68 Cafeeiro * 78 * 80 * M80 * 85 * 85ID * 86 * 86 ID * 88 * 88 ID Tratores 360 D * 600 D * 621 ID				
			FORD	F 75 Rural	Tomada de Força / Toma de Fuerza / Power Take-off		
			TOYOTA	Bandeirante			
		6203 ZZ / C3	BB	References Fersa with Multiple Applications / Referências Fersa com Múltiplas Aplicações / Referencias Fersa con Multiples Aplicaciones			
		6204	BB		MERCEDES BENZ	1113 (LPO*OH) * 1114 LPO * 1115 L (OH) * 1118 LPO	Embreagem / Embrague / Clutch
						1517 OH * 1518 OH * 1519 OH * 1520 OH * 1521 OH	Motor / Motor / Engine
321 H (O) * 321 HL (O) (58...71)	Embreagem / Embrague / Clutch						
326 O	Motor / Motor / Engine						
352 HL (O) (...74)	Embreagem / Embrague / Clutch						
355 O	Motor / Motor / Engine						
SCANIA	K 94 IB (4X2)				Embreagem / Embrague / Clutch		
VOLVO	B 10M BR				Motor / Motor / Engine		
	B 10R * B 12B * B 12R * B 58 * B 58BR * B 7R * B9						
	B 58						
	B 58 BR (...Chassi 304120)						
MERCEDES BENZ	1018 MBO				Embreagem / Embrague / Clutch		
	1111 (L*LA*LAK* LAS*LK*LS)						
	1113 (L*LA*LAK*LAS*LK*LP*LS*LP) * 1114 * 1114 (L*LK*LP) * 1116 (L*LA*LAK*LAS*LB* LK*LS) * 1118 (L*LK*LP)						
	1113 OF * 1115 OF			Motor / Motor / Engine			
	1513 (L*LA*LAK*LB*LG*LK*LS) * 1514 (L*LK*LS) * 1516 (L*LA*LAK*LB*LG*LK*LS) * 1517 (L*LK) * 1518 (L*LK*LS) * 1519 (L*LAK*LB*LG*LK*LS) * 1520 (L*LK*LP*LPK*LPS*LS) * 1521 L * 1524 e 1525 (L*LK*LS)						
	1517 OF * 1518 OF * 1520 OF						
	2213 (L*LB*LK*LS) * 2213 6X6 (LA) * 2214 * 2215 (L*LB*LK*LS) * 2216 (L*LA*LAK*LB*LG*LK*LS) * 2217 (L*LB*LK*LS) * 2219 (L*LA*LAK*LB*LG*LK*LS) * 2220 * 2222 * 2225 (L*LB*LK*LS)						
	312 (L*LK*LP) 51...58						
	321 (LAP*LAPK*LAPS*LP* LPK*LPS) 51...71						
	321 LAP * LAPK * LAPS * LP * LPK * LPS			Embreagem / Embrague / Clutch			
	331 (L*LPK*LPS) 60...68						
	75 * 76 B*L*LS						
SCANIA	P 94 CB (4x2 * 6x2 * 6X4)			Motor / Motor / Engine			
	P 94 GA*GB (4X2)						
	MERCEDES BENZ			1018 MBO	Embreagem / Embrague / Clutch		
				1113 OF * 1115 OF	Motor / Motor / Engine		
	FORD			F 100	Motor / Motor / Engine		
				F 1000 (79...)			
				F 2000			
		F 350					
		F 400					
		F 4000					









Fersa®			Brand / Marca / Marca	Model / Modelo / Modelo	Application / Aplicação / Aplicaciones
6204 2RS	BB		AGCO MAXION	Colheteira Combinada Automotriz 1170DS * 1175DS * 1630 Arroeira * 3640 Arroeira * 5650 * MF 220A * 220CBD * 220STD * MF 310CBD * 310STD * 210 * 210S * 220 * 310	Canal de Descarga / Canal de Descarga / Discharge Channel
					Canal Elevador de Grãos / Canal Elevador de Grãos / Grain Elevator Channel
					Conjunto Saca-palha / Conjunto Saca-Paja / Straw Extractor
					Elevador de Descarga / Elevador de Descarga / Discharge Elevator
					Elevador de Grãos / Elevador de Grãos / Grain Elevator
					Elevador de Retilha / Elevador de Trilla
					Limpeza / Limpeza / Cleaning
					Plataforma Flexível / Plataforma Flexível / Flexível Platform
					Tanque de Grãos / Tanque de Grãos / Grain Tank
					Tomada de Potência / Toma de Potencia / Power Take-off
			FNH	Colheitadeiras 4040 * 5030 * 5050 * 8040 * 8055 * TC55 * TC57 * CA1530	Batedor / Bastidor / Chassis
					Elevador de Retilha / Elevador de Trilla
			MERCEDES BENZ	1113 (LPO*OH) * 1114 LPO * 1115 L (OH) * 1118 LPO 1313 OH * 1314 OH * 1315 OH * 1316 (OH*OHL) * 1316 G (OH*OHL) * 1317 OH * 1318 OH * 1319 OH * 1320 (OH*OHL) 1418 OH * 1419 OH * 1420 (OH*OHL) * 1421 OHL 1517 OH * 1518 OH * 1519 OH * 1520 OH * 1521 OH 1621 L (OH) * 1623 LG (OH) * 1625 (OH) * 1625 L (OH) * 1628 L (OH) * 1630L (OH) * 1635 (OH) * 1636 L (OH) 1721 L (OH) 352 HL (O) (...74) 355 (O) 362 (O) 364 O 370 RS*RSD*RST* ST*U*UP (O) * 371 RS*RSD*RST* ST*U*UP (O) 608 D * E (L*LO) * 708 D * E (L*LO) * 709 L * 710 L * 712 L 812 LO * 912 L	Motor / Motor / Engine
					Embreagem / Embrague / Clutch
					Motor / Motor / Engine
					Embreagem / Embrague / Clutch
					Motor / Motor / Engine
					Embreagem / Embrague / Clutch
					Embreagem / Embrague / Clutch
					Embreagem / Embrague / Clutch
					Embreagem / Embrague / Clutch
					Embreagem / Embrague / Clutch
					Embreagem / Embrague / Clutch
					Embreagem / Embrague / Clutch
Embreagem / Embrague / Clutch					
	FORD				F 100 (61...80 Diesel) * F 600 (56...77 Gas.) * F 700 (77...80) * F 750 (72...77) * 750 * 2000 * 4000
		MERCEDES BENZ	1113 (L*LA*LAK*LAS*LK*LP*LS*LP) * 1114 * 1114 (L*LK*LP) * 1116 (L*LA*LAK*LAS*LB*LK*LS) * 1118 (L*LK*LP) 1113 OF * 1115 OF 1214 C * 1214 K * 1214 (L*LK*LS) * 1215 * 1215 C * 1215 (L*LA*LK) * 1218 * 1218 R (L) 1215 OF * 1217 OF 1313 (L*LA*LAK*LB*LK*LS) * 1314 (L*LA*LAK*LB*LK*LS) * 1316 (L*LA*LAK*LAS*LB*LK*LS) * 1317 (L*LA*LAK*LK*LS) * 1319 (L) 1313 OF * 1314 OF * 1315 OF * 1316 OF * 1317 OF * 1318 OF * 1319 OF * 1320 OF 1414 * 1414 (K*L*LA*LAK*LK) * 1418 * 1418 (E*K*R) * 1418 (L*LA*LAK*LK*R(LK)) * 1419 (L*LK*LS) * 1420 (L*LK*LS) 1417 OF * 1419 OF * 1421 OF 1421 OMC 1513 (L*LA*LAK*LB*LG*LK*LS) * 1514 (L*LK*LS) * 1516 (L*LA*LAK*LB*LG*LK*LS) * 1517 (L*LK) * 1518 (L*LK*LS) * 1519 (L*LAK*LB*LG*LK*LS) * 1520 (L*LK*LP*LPK*LPS*LS) * 1521 L * 1524 e 1525 (L*LK*LS)	Embreagem / Embrague / Clutch	
				Motor / Motor / Engine	
				Embreagem / Embrague / Clutch	
				Motor / Motor / Engine	
		Embreagem / Embrague / Clutch			
		Motor / Motor / Engine			
		Embreagem / Embrague / Clutch			
		Motor / Motor / Engine			
		Embreagem / Embrague / Clutch			
Motor / Motor / Engine					



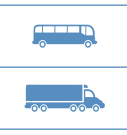



Fersa*			Brand / Marca / Marca	Model / Modelo / Modelo	Application / Aplicação / Aplicaciones
6204 2RS	BB		MERCEDES BENZ	1517 OF * 1518 OF * 1520 OF	Embreagem / Embrague / Clutch
				1620(L*LK*LS) * 1620 6X2 51 (L) * 1621 (L*LK*LS) * 1622(L*LK*LS) * 1623 (L*LS) * 1625(L*LK*LS) * 1630 (L*LK*LS) * 1632 (L*LS) * 1633(L*LK*LS) * 1634 (L*LS) * 1635 L	Motor / Motor / Engine
				1620 OF * 1621 OF	
				1714 OF * 1721 OF * 1722 OF	
				1714 * 1714 (L*K*LK) * 1715 * 1718 * 1718 (A * AK) * K * 1720 L * 1721 * 1721 S * 1721 (L*LK) * 1722 S * 1723 * 1723 S * 1725 L	Embreagem / Embrague / Clutch
				2013 (L*LA*LAK*LB*LG*LK*LS) * 2013 6X2 (L) * 2014 (L*LB*LK) * 2016 (LB*LK) * 2017 (L*LB*LK)	
				2213 (L*LB*LK*LS) * 2213 6X6 (LA) * 2214 * 2215 (L*LB*LK*LS) * 2216 (L*LA*LAK*LB*LG*LK*LS) * 2217 (L*LB*LK*LS) * 2219 (L*LA*LAK*LB*LG*LK*LS) * 2220 * 2222 * 2225 (L*LB*LK*LS)	
				2314 (L*LB*LK*LS) * 2318 (L*LB*LK*LS) * 2325 (L*LB*LK*LS)	Motor / Motor / Engine
				2414 (6X4) * 2414 (L) * 2418 (L*LB*LK) * 2420 (L*LB*LK) * 2423 B 6X4 * 2423 K 6X4 * 2425 6X6 (LA) * 2425 (L*LB*LK) * 2428 6X4	
			MERCEDES BENZ	1113 OF * 1115 OF	Embreagem / Embrague / Clutch
				1215 OF * 1217 OF	
				1313 OF * 1314 OF * 1315 OF * 1316 OF * 1317 OF * 1318 OF * 1319 OF * 1320 OF	Motor / Motor / Engine
				1417 OF * 1419 OF * 1421 OF	
				1421 OMC	Embreagem / Embrague / Clutch
				1517 OF * 1518 OF * 1520 OF	
				1620 OF * 1621 OF	
				1714 OF * 1721 OF * 1722 OF	Motor / Motor / Engine
6204 2RS / C3	BB				AGRALE
		MERCEDES BENZ	1113 (LPO*OH) * 1114 LPO * 1115 L (OH) * 1118 LPO		
			1313 OH * 1314 OH * 1315 OH * 1316 (OH*OHL) * 1316 G (OH*OHL) * 1317 OH * 1318 OH * 1319 OH * 1320 (OH*OHL)		
			1418 OH * 1419 OH * 1420 (OH*OHL) * 1421 OHL		
			1517 OH * 1518 OH * 1519 OH * 1520 OH * 1521 OH		Embreagem / Embrague / Clutch
			1721 L (OH)		
			352 HL (O) (...74)		
			355 O		
			362 O		
		364 O			
		608 D * E (L*LO) * 708 D * E (L*LO) * 709 L * 710 L * 712 L	Motor / Motor / Engine		
		6000E-MEC * 6000E-TRONIC FURGOVAN * 8000E-MEC FURGOVAN * 8500E-MEC * 8500CD-E MEC * 8500E-TRONIC			
		DODGE		400 * 450 * 700 * 750 * 900 * 950	
		FORD		F 100 (61...80 Diesel) * F 600 (56...77 Gas.) * F 700 (77...80) * F 750 (72...77) * 750 * 2000 * 4000	
		MERCEDES BENZ		608 (L*LO) * 708 (L*LO) * 809 (LO*OF) * 812 (LO*OF) * 814 LO * 817 O * 914 LO * 709 * 710 * 712 * 712 C * 811 * 911 L * 912 * 913 * 914 * 914 C * 917	
				1113 (L*LA*LAK*LAS*LK*LP*LS*LP) * 1114 * 1114 (L*LK*LP) * 1116 (L*LA*LAK*LAS*LB* LK*LS) * 1118 (L*LK*LP)	
				1113 OF * 1115 OF	
				1214 C * 1214 K * 1214 (L*LK*LS) * 1215 * 1215 C * 1215 (L*LA*LK) * 1218 * 1218 R (L)	
	1215 OF * 1217 OF				
	1313 (L*LA*LAK*LB*LK*LS) * 1314 (L*LA*LAK*LB*LK*LS) * 1316 (L*LA*LAK*LAS*LB*LK*LS) * 1317 (L*LA*LAK*LK*LS)* 1319 (L)				
	1313 OF * 1314 OF * 1315 OF * 1316 OF * 1317 OF * 1318 OF * 1319 OF * 1320 OF				
		MERCEDES BENZ	1113 OF * 1115 OF	Motor / Motor / Engine	
			1214 C * 1214 K * 1214 (L*LK*LS) * 1215 * 1215 C * 1215 (L*LA*LK) * 1218 * 1218 R (L)		
			1215 OF * 1217 OF		
			1313 (L*LA*LAK*LB*LK*LS) * 1314 (L*LA*LAK*LB*LK*LS) * 1316 (L*LA*LAK*LAS*LB*LK*LS) * 1317 (L*LA*LAK*LK*LS)* 1319 (L)		
			1313 OF * 1314 OF * 1315 OF * 1316 OF * 1317 OF * 1318 OF * 1319 OF * 1320 OF		









Fersa®			Brand / Marca / Marca	Model / Modelo / Modelo	Application / Aplicação / Aplicaciones	
6204 2RS / C3	BB		MERCEDES BENZ	1414 * 1414 (K*L*LA*LAK*LK) * 1418 * 1418 (E*K*R) * 1418 (L*LA*LAK*LK*R(LK)) * 1419 (L*LK*LS) * 1420 (L*LK*LS)	Motor / Motor / Engine	
				1417 OF * 1419 OF * 1421 OF		
				1421 OMC		
				1513 (L*LA*LAK*LB*LG*LK*LS) * 1514 (L*LK*LS) * 1516 (L*LA*LAK*LB*LG*LK*LS) * 1517 (L*LK) * 1518 (L*LK*LS) * 1519 (L*LAK*LB*LG*LK*LS) * 1520 (L*LK*LP*LPK*LPS*LS) * 1521 L * 1524 e 1525 (L*LK*LS)	Embreagem / Embrague / Clutch	
				1517 OF * 1518 OF * 1520 OF	Motor / Motor / Engine	
				1614 * 1615 (L*LK*LS) * 1615 * 1618 M * 1618 (L*LK*LS) * 1619 (L)		
				1618 OF		
				1714 OF * 1721 OF * 1722 OF		
				1714 * 1714 (L*K*LK) * 1715 * 1718 * 1718 (A * AK) * K * 1720 L * 1721 * 1721 S * 1721 (L*LK) * 1722 S * 1723 * 1723 S * 1725 L	Embreagem / Embrague / Clutch	
				1924 (LS) * 1924 A (LS) * 1929 (L*LK*LS) * 1930 (LS) * 1932 (LS) * 1933 (LS) * 1934 (LS) * 1935 (L*LS) * 1938 * 1938 S * 1938 (L*LS) * 1941 (L*LS) * 1944 S * 1945 (L*LS)		
		2013 (L*LA*LAK*LB*LG*LK*LS) * 2013 6X2 (L) * 2014 (L*LB*LK) * 2016 (LB*LK) * 2017 (L*LB*LK)	Motor / Motor / Engine			
		2213 (L*LB*LK*LS) * 2213 6X6 (LA) * 2214 * 2215 (L*LB*LK*LS) * 2216 (L*LA*LAK*LB*LG*LK*LS) * 2217 (L*LB*LK*LS) * 2219 (L*LA*LAK*LB*LG*LK*LS) * 2220 * 2222 * 2225 (L*LB*LK*LS)				
		2314 (L*LB*LK*LS) * 2318 (L*LB*LK*LS) * 2325 (L*LB*LK*LS)				
		2414 (6X4) * 2414 (L) * 2418 (L*LB*LK) * 2420 (L*LB*LK) * 2423 B 6X4 * 2423 K 6X4 * 2425 6X6 (LA) * 2425 (L*LB*LK) * 2428 6X4				
		13-130 * 13-150 * 13-170 * 13-180E * 13-190 (77...)E * 13-210				
		6-80 * 6-90 * 6-90 (P*S)				
				MERCEDES BENZ	1113 OF * 1115 OF	Embreagem / Embrague / Clutch
					1215 OF * 1217 OF	
					1313 OF * 1314 OF * 1315 OF * 1316 OF * 1317 OF * 1318 OF * 1319 OF * 1320 OF	
					1417 OF * 1419 OF * 1421 OF	Motor / Motor / Engine
1421 OMC						
1517 OF * 1518 OF * 1520 OF						
1618 OF						
1714 OF * 1721 OF * 1722 OF						
	FNH		Todos / Todos / All			
6204 C3	BB		FIAT	Marea * Marea Turbo * Marea Weekend Tipo	Motor / Motor / Engine	
6204 Z	BB		AGCO MAXION	Colheteira Combinada Automotriz 1170DS * 1175DS * 1630 Arrozadeira * 3640 Arrozadeira * 5650 * MF 220A * 220CBD * 220STD * MF 310CBD * 310STD * 210 * 210S * 220 * 310	Espalhador de Palha / Espargidor de Paja / Straw Spreader	
			CBT	2070 * 2080 * 2100 * 2105 (4x2) * 2400 * 2400 (4x4) * 2500 * 2600 Tratores 1000 * 1000 (4x4) * 1020 * 1020 (4x4) * 1065 * 1065 (4x4) * 1090 * 1105		Motor / Motor / Engine
6204 ZZ	BB		AGCO MAXION	Tratores MF 235 (4x4) Antigo * MF 235 Moderno* 250 * 265 * MF265 RD * 270 * 274 * 275 * 285 * 290 * MF 292 (4x4) * 295 * 296 * 299	Embreagem / Embrague / Clutch	
			AGRALE	M80 * M85 * M90 Tratores 4100 * 4200 * 4300 * T145 * T146 * T415 * T420		Eixo Cardan / Eje Cardan / Cardan Shaft
6204 ZZ / C3	BB	References Fersa with Multiple Applications / Referências Fersa com Múltiplas Aplicações / Referencias Fersa con Multiples Aplicaciones				
6205	BB		MERCEDES BENZ	1517 OH * 1518 OH * 1519 OH * 1520 OH * 1521 OH	Motor / Motor / Engine	
				326 O	Embreagem / Embrague / Clutch	
			SCANIA	140 (LK*LKS) K 94 IB (4X2)	Motor / Motor / Engine	
			VOLVO	B 10M BR		
			B 10R * B 12B * B 12R * B 58 * B 58BR * B 7R * B9 B 58			













Fersa®			Brand / Marca / Marca	Model / Modelo / Modelo	Application / Aplicação / Aplicaciones
6205	BB		VOLVO	B 58 BR (...Chassi 304120)	Motor / Motor / Engine
			FIAT	FNM D-11000 (58...72)	
				FNM D-9500 (50...57)	
			MERCEDES BENZ	1513 (L*LA*LAK*LB*LG*LK*LS) * 1514 (L*LK*LS) * 1516 (L*LA*LAK*LB*LG*LK*LS) * 1517 (L*LK) * 1518 (L*LK*LS) * 1519 (L*LAK*LB*LG*LK*LS) * 1520 (L*LK*LP*LPK*LPS*LS) * 1521 L * 1524 e 1525 (L*LK*LS)	
				1517 OF * 1518 OF * 1520 OF	
		SCANIA	331 (L*LPK*LPS) 60...68	Embream / Embrague / Clutch	
			P 94 CB (4x2 * 6x2 * 6X4) P 94 GA*GB (4X2)	Motor / Motor / Engine	
			MERCEDES BENZ	1517 OF * 1518 OF * 1520 OF	Tomada de Força / Toma de Fuerza / Power Take-off
			AGRALE	Tratores 4100 * 4200 * 4300 * T145 * T146 * T415 * T420	Motor / Motor / Engine
			CBT	Tratores 8060 (4x2) * 8060 (4x4) * 8240 * 8240A * 8260 * 8440 * 8450	Elevador de Retilha / Elevador de Trilla
			FNH	Colheitadeiras 4040 * 5030 * 5050 * 8040 * 8055 * TC55 * TC57 * CA1530	Câmbio / Caja de Cambios / Gearbox
		LADA	Besta (2.2 * 2.7 * GS)		
			1600		
		PEUGEOT	Laika (1.6)	205	
			Niva		
6205 2RS	BB		MERCEDES BENZ	1517 OH * 1518 OH * 1519 OH * 1520 OH * 1521 OH	Embream / Embrague / Clutch
				352 HL (O) (...74)	Motor / Motor / Engine
				355 O	Embream / Embrague / Clutch
			362 O		
			364 O		
			SCANIA	370 RS*RSD*RST* ST*U*UP (O) * 371 RS*RSD*RST* ST*U*UP (O)	Motor / Motor / Engine
				101 (L*LS) * 111 (B) * 111 Articulado (B)	
				110 (B)	
				110 (L*LS)	
		111 (L*LS*LT)			
		115 * 116 BR			
			MERCEDES BENZ	K 113	Embream / Embrague / Clutch
				P 93 * R 113 * R 143* T 113	
				1018 MBO	
			MERCEDES BENZ	1111 (L*LA*LAK* LAS*LK*LS)	Embream / Embrague / Clutch
				1513 (L*LA*LAK*LB*LG*LK*LS) * 1514 (L*LK*LS) * 1516 (L*LA*LAK*LB*LG*LK*LS) * 1517 (L*LK) * 1518 (L*LK*LS) * 1519 (L*LAK*LB*LG*LK*LS) * 1520 (L*LK*LP*LPK*LPS*LS) * 1521 L * 1524 e 1525 (L*LK*LS)	Motor / Motor / Engine
				1517 OF * 1518 OF * 1520 OF	Embream / Embrague / Clutch
				1819 (L*LAK*LB*LG*LK*LS) * 1820 LG	Motor / Motor / Engine
1924 (LS) * 1924 A (LS) * 1929 (L*LK*LS) * 1930 (LS) * 1932 (LS) * 1933 (LS) * 1934 (LS) * 1935 (L*LS) * 1938 * 1938 S * 1938 (L*LS) * 1941 (L*LS) * 1944 S * 1945 (L*LS)	Embream / Embrague / Clutch				
2213 (L*LB*LK*LS) * 2213 6X6 (LA) * 2214 * 2215 (L*LB*LK*LS) * 2216 (L*LA*LAK*LB*LG*LK*LS) * 2217 (L*LB*LK*LS) * 2219 (L*LA*LAK*LB*LG*LK*LS) * 2220 * 2222 * 2225 (L*LB*LK*LS)	Motor / Motor / Engine				
MERCEDES BENZ	Axor 2625 * 2628 * 2629 (L*K*LS) * 2631 (B*K*L) * 2632 * 2635 (B*K*L) * 2635 (L*LK*LS) * 2635 * 2638 (L*LK*LS) * Axor 2640 * 2641 * 2643 * Axor 2644 * Actos 2646 * 2648 * 2650 * 2651 * 2653 * 2654 (L*LK*LS) * 2657 * 2658 * 2644 * Atego 2628 (B*K) * 2625 * Axor 2826 * Axor 2828 * Axor 2831	Embream / Embrague / Clutch			
	2629 LS				
	2635 (L*LK*LS)				













Fersa®			Brand / Marca / Marca	Model / Modelo / Modelo	Application / Aplicação / Aplicaciones	
6205 2RS	BB		SCANIA	112 (F*K*S)	Motor / Motor / Engine	
				75 * 76 B*L*LS		
				F 113 * L 113 * K 113		
				P 114 GA (4X2) * R 114 GA (4X2 * 6X4) * T 114 GA (4X2) * T 114 LA (6X2)		
				R 112 (81...)		
			MERCEDES BENZ	1517 OF * 1518 OF * 1520 OF	Embreagem / Embrague / Clutch	
					Motor / Motor / Engine	
			AGCO MAXION	Colheteira Combinada Automotriz 1170DS * 1175DS * 1630 Arroeira * 3640 Arroeira * 5650 * MF 220A * 220CBD * 220STD * MF 310CBD * 310STD * 210 * 210S * 220 * 310	Limpeza / Limpieza / Cleaning	
					Plataforma Dianteira / Plataforma Delantera / Front Platform	
					Tanque de Grãos / Tanque de Granos / Grain Tank	
					Acionamento da Plataforma / Accionamiento de Plataforma / Drive Platform	
					Batedor / Bastidor / Chassis	
					Câmbio / Caja de Cambios / Gearbox	
					Classificador / Clasificador / Sorter Unit	
					Elevador de Grãos / Elevador de Granos / Grain Elevator	
					Elevador de Palha / Elevador de Paja / Straw Elevator	
					Elevador de Retilha / Elevador de Trilla	
					Molinete / Cojinete / Bearing	
					Motor / Motor / Engine	
					Picador de Palha / Picador de Paja / Straw Chopper	
	Saca-Palhas / Empacadora / Packing					
	Tomada de Ar / Entrada de Aire / Air inlet					
	Tubo de Descarga / Tubo de Descarga / Discharge Tube					
	Variador / Variador / Variable drive					
VALTRA - VALMET	Tratores 60 * 60 ID * 62 * 65 * 65 Cafeeiro * 68 * 68 Cafeeiro * 78 * 80 * M80 * 85 * 85ID * 86 * 86 ID * 88 * 88 ID	Direção / Dirección / Steering				
		Tratores 110 ID * 110ID II * 118 * 118 (4x4) * 128 * 128 (4x4)	Câmbio / Caja de Cambios / Gearbox			
	Tratores 1280 * 1284 * 1580 * 1780 * 1780 (4x4) * 1380 * 1680 * 1880 * 118 * 128 * 138 * 148 * 148 (4x4)					
	Tratores 870 CN * CK	Embreagem / Embrague / Clutch				
	Tratores 360 D * 600 D * 621 ID	Direção / Dirección / Steering				
	Tratores 685 * 685C (4x4) * 785 * 785C (4x4) * 880 Cafeeiro * 880 (4x4) * 885 * 980 (4x4) * 985 * 985F * 1180 * 1184	Embreagem / Embrague / Clutch				
	1018 MBO					
	1517 OF * 1518 OF * 1520 OF	Motor / Motor / Engine				
	6205 2RS / C3	BB		SCANIA	101 (L*LS) * 111 (B) * 111 Articulado (B)	Motor / Motor / Engine
					110 (B)	
110 (L*LS)						
115 * 116 BR						
140 (LK*LKS)						
			SCANIA	112 (F*K*S)		
				75 * 76 B*L*LS		
				R 112 (81...)		
				R 142 MA (4X2)(81...)		
				T 142 E (6X4)		
FORD			F 100 (61...80 Diesel) * F 600 (56...77 Gas.) * F 700 (77...80) * F 750 (72...77) * 750 * 2000 * 4000			











Fersa®			Brand / Marca / Marca	Model / Modelo / Modelo	Application / Aplicação / Aplicaciones	
6205 C3	BB		SCANIA	140 (LK*LKS)	Motor / Motor / Engine	
			SCANIA	R 142 MA (4X2)(81...) T 142 E (6X4)		
			SCANIA	115 * 116 BR K 94 IB (4X2)		
6205 RS	BB		SCANIA	P 94 CB (4x2 * 6x2 * 6X4) P 94 GA*GB (4X2)	Motor / Motor / Engine	
			SCANIA			
6205 RS / C3	BB		VOLVO	B 10M BR B 10R * B 12B * B 12R * B 58 * B 58BR * B 7R *B9	Motor / Motor / Engine	
			VOLVO			
6205 Z	BB		FIAT	130 (76...)	Embreagem / Embrague / Clutch	
				130 OD (78...)	Motor / Motor / Engine	
				70 (77...) * 80	Embreagem / Embrague / Clutch	
			GENERAL MOTORS	6-100 (4X2)* 6-150* 12-170 L*S (4X2)* 14-190 (77...) (4X2)* 15-190 (77...) (4X2)* 16-220 (4X2)	Motor / Motor / Engine	
		AGCO MAXION	Colhedeira Combinada Automotriz 1170DS * 1175DS * 1630 Arrozadeira * 3640 Arrozadeira * 5650 * MF 220A * 220CBD * 220STD * MF 310CBD * 310STD * 210 * 210S * 220 * 310	Espalhador de Palha / Esparcidor de Paja / Straw Spreader		
		FNH	Colheitadeiras 4040 * 5030 * 5050 * 8040 * 8055 * TC55 * TC57 * CA1530	Batedor / Bastidor / Chassis Picador de Palha / Picador de Paja / Straw Chopper		
		VALTRA - VALMET			Tratores 60 * 60 ID * 62 * 65 * 65 Cafeeiro * 68 * 68 Cafeeiro * 78 * 80 * M80 * 85 * 85ID * 86 * 86 ID * 88 * 88 ID	Câmbio / Caja de Cambios / Gearbox Conjunto da Polia / Conjunto de Polea / Pulley Assembly
					Tratores 110 ID * 110ID II * 118 * 118 (4x4) * 128 * 128 (4x4)	Embreagem / Embrague / Clutch Câmbio / Caja de Cambios / Gearbox
					Tratores 360 D * 600 D * 621 ID	Eixo Traseiro / Eje Trasero / Rear Axle
					Tratores 685 * 685C (4x4) * 785 * 785C (4x4) * 880 Cafeeiro * 880 (4x4) * 885 * 980 (4x4) * 985 * 985F * 1180 * 1184	Embreagem / Embrague / Clutch Direção / Dirección / Steering
		GENERAL MOTORS	A-C-D (10*14*15*20*40) * Bonanza * Veraneio * D1000 D 40	Motor / Motor / Engine		
		6205 ZZ	BB		GENERAL MOTORS	A-C-D 60* 70* 80* 90* 99 Turbo e 3500 Heavy Duty
AGRALE	Tratores 4100 * 4200 * 4300 * T145 * T146 * T415 * T420				Eixo Cardan / Eje Cardan / Cardan Shaft Embreagem / Embrague / Clutch	
	TOYOTA			Bandeirante	Tomada de Força / Toma de Fuerza / Power Take-off	
6205 ZZ / C3	BB	References Fersa with Multiple Applications / Referências Fersa com Múltiplas Aplicações / Referencias Fersa con Múltiples Aplicaciones				
6206	BB		MERCEDES BENZ	1113 (LPO*OH) * 1114 LPO * 1115 L (OH) * 1118 LPO	Tomada de Potência / Toma de Potencia / Power Take-off	
				1418 OH * 1419 OH * 1420 (OH*OHL) * 1421 OHL		
				321 H (O) * 321 HL (O) (58...71)		
				326 O		
				352 HL (O) (...74)		
				355 O		
				362 O		
				364 O		
				364 HL (O) (...74)		
				608 D * E (L*LO) * 708 D * E (L*LO) * 709 L * 710 L * 712 L		
				812 LO * 912 L		
				VOLVO		B 10M BR B 10R * B 12B * B 12R * B 58 * B 58BR * B 7R *B9 B 58 B 58 BR (...Chassi 304120)
			VOLVO			









Fersa®			Brand / Marca / Marca	Model / Modelo / Modelo	Application / Aplicação / Aplicaciones	
6206	BB		MERCEDES BENZ	608 (L*LO) * 708 (L*LO) * 809 (LO*OF) * 812 (LO*OF) * 814 LO * 817 O * 914 LO * 709 * 710 * 712 * 712 C * 811 * 911 L * 912 * 913 * 914 * 914 C * 917	Motor / Motor / Engine	
				1018 MBO	Tomada de Força / Toma de Fuerza / Power Take-off	
				1111 (L*LA*LAK* LAS*LK*LS)	Tomada de Potência / Toma de Potencia / Power Take-off	
				1113 (L*LA*LAK*LAS*LK*LP*LS*LP) * 1114 * 1114 (L*LK*LP) * 1116 (L*LA*LAK*LAS*LB* LK*LS) * 1118 (L*LK*LP)		
				1113 OF * 1115 OF		
				1414 * 1414 (K*L*LA*LAK*LK) * 1418 * 1418 (E*K*R) * 1418 (L*LA*LAK*LK*R(LK)) * 1419 (L*LK*LS) * 1420 (L*LK*LS)	Motor / Motor / Engine	
				1417 OF * 1419 OF * 1421 OF		
				1421 OMC		
				1819 (L*LAK*LB*LG*LK*LS) * 1820 LG		
				Axor 2625 * 2628 * 2629 (LK*LS) * 2631 (B*K*L) * 2632 * 2635 (B*K*L) * 2635 (L*LK*LS) * 2635 * 2638 (L*LK*LS) * Axor 2640 * 2641 * 2643 * Axor 2644 * Actos 2646 * 2648 * 2650 * 2651 * 2653 * 2654 (L*LK*LS) * 2657 * 2658 * 2644 * Atego 2628 (B*K) * 2625 * Axor 2826 * Axor 2828 * Axor 2831		
				2629 LS		
				2635 (L*LK*LS)		
				321 (LAP*LAPK*LAPS*LP* LPK*LPS) 51...71	Tomada de Força / Toma de Fuerza / Power Take-off	
		321 LAP * LAPK * LAPS * LP * LPK * LPS	Tomada de Potência / Toma de Potencia / Power Take-off			
		VOLVO	Motor / Motor / Engine			
				FH 12 * FH 16 N * NL 10 BR * N * NL 12 BR * N 10BR Mark II * NL 10BR 6x2		
			MERCEDES BENZ	1417 OF * 1419 OF * 1421 OF	Motor / Motor / Engine	
				1421 OMC		
			AGRALE	Tratores 4100 * 4200 * 4300 * T145 * T146 * T415 * T420	Embreagem / Embrague / Clutch	
				CBT	2070 * 2080 * 2100 * 2105 (4x2) * 2400 * 2400 (4x4) * 2500 * 2600	Motor / Motor / Engine
Tratores 1000 * 1000 (4x4) * 1020 * 1020 (4x4) * 1065 * 1065 (4x4) * 1090 * 1105						
FNH	Colheitadeiras 4040 * 5030 * 5050 * 8040 * 8055 * TC55 * TC57 * CA1530	Batedor / Bastidor / Chassis Elevador de Grãos / Elevador de Granos / Grain Elevator Motor / Motor / Engine				
6206 2RS	BB		MERCEDES BENZ	1924 (LS) * 1924 A (LS) * 1929 (L*LK*LS) * 1930 (LS) * 1932 (LS) * 1933 (LS) * 1934 (LS) * 1935 (L*LS) * 1938 * 1938 S * 1938 (L*LS) * 1941 (L*LS) * 1944 S * 1945 (L*LS)	Motor / Motor / Engine	
				2213 (L*LB*LK*LS) * 2213 6X6 (LA) * 2214 * 2215 (L*LB*LK*LS) * 2216 (L*LA*LAK*LB*LG*LK*LS) * 2217 (L*LB*LK*LS) * 2219 (L*LA*LAK*LB*LG*LK*LS) * 2220 * 2222 * 2225 (L*LB*LK*LS)		
				2414 (6X4) * 2414 (L) * 2418 (L*LB*LK) * 2420 (L*LB*LK) * 2423 B 6X4 * 2423 K 6X4 * 2425 6X6 (LA) * 2425 (L*LB*LK) * 2428 6X4		
				VOLVO		Motor / Motor / Engine
				FH 12 * FH 16 * FH 16 N * NL 10 BR * N * NL 12 BR * N 10BR Mark II * NL 10BR 6x2 NH 12 * FM 12		
			AGCO MAXION	Batedor Traseiro / Bastidor Trasero / Rear Chassis Câmbio / Caja de Cambios / Gearbox Conjunto Saca-palha / Conjunto Saca-Paja / Straw Extractor Elevador de Descarga / Elevador de Descarga / Discharge Elevator Elevador de Retilha / Elevador de Trilla Limpeza / Limpieza / Cleaning Motor / Motor / Engine		
				Colheitadeira Combinada Automotriz 1170DS * 1175DS * 1630 Arrozadeira * 3640 Arrozadeira * 5650 * MF 220A * 220CBD * 220STD * MF 310CBD * 310STD * 210 * 210S * 220 * 310		













Fersa®			Brand / Marca / Marca	Model / Modelo / Modelo	Application / Aplicação / Aplicaciones
6206 2RS	BB		AGCO MAXION	Colheitadeira Combinada Automotriz 1170DS * 1175DS * 1630 Arroeira * 3640 Arroeira * 5650 * MF 220A * 220CBD * 220STD * MF 310CBD * 310STD * 210 * 210S * 220 * 310	Plataforma de Milho / Plataforma de Maiz / Corn Platform Tanque de Grãos / Tanque de Granos / Grain Tank Tomada de Potência / Toma de Potencia / Power Take-off Tração do Carregador / Tracción de Cargador / Traction Charger Transmissão das Peneiras / Transmisión de Tamices / Sieves Transmission Variador de Tração / Variador de Tracción / Traction Variable Drive
			FNH	Colheitadeiras 4040 * 5030 * 5050 * 8040 * 8055 * TC55 * TC57 * CA1530	Batedor / Bastidor / Chassis Classificador / Clasificador / Sorter Unit Elevador de Grãos / Elevador de Granos / Grain Elevator Elevador de Palha / Elevador de Paja / Straw Elevator Elevador de Retilha / Elevador de Trilla Picador de Palha / Picador de Paja / Straw Chopper Sem Fim de Descarga / SinFin de Descarga / Discharge Worm Sobretanque / Sobretanque Tubo de Descarga / Tubo de Descarga / Discharge Tube Variador de Tração / Variador de Tracción / Traction Variable Drive
6206 2RS / C3	BB		FORD	F 100 (61...80 Diesel) * F 600 (56...77 Gas.) * F 700 (77...80) * F 750 (72...77) * 750 * 2000 * 4000	Motor / Motor / Engine
				F 11000 * F 12000	
				F 13000 * F 14000 * F 16000	
				F 19000 (77...) * F 21000 * F 22000	
6206 C3	BB		ALFA ROMEO	Alfa 2300	Cardan / Cardan / Cardan
			GENERAL MOTORS	Caravan * Opala	Câmbio / Caja de Cambios / Gearbox
				S 10 (2.2 * 2.4 * 2.5 * 2.8 TD * 4.3) S 10 * Blazer	
6206 C3	BB		MERCEDES BENZ	1113 OF * 1115 OF	Motor / Motor / Engine
				1215 OF * 1217 OF	
				1313 OF * 1314 OF * 1315 OF * 1316 OF * 1317 OF * 1318 OF * 1319 OF * 1320 OF	
				1517 OF * 1518 OF * 1520 OF	
				1618 OF	
				1620 OF * 1621 OF	
			FORD	Belina II (79...) * Corcel II (79...)	Caixa de transferência / Caja de Transferencia / Transfer Case
				F 75	Del Rey * Pampa
					Jeep Willys (4X2 * 4X4) (60...83) Rural (4X2 * 4X4)
			MERCEDES BENZ	1113 (LPO*OH) * 1114 LPO * 1115 L (OH) * 1118 LPO	Motor / Motor / Engine
				1313 OH * 1314 OH * 1315 OH * 1316 (OH*OHL) * 1316 G (OH*OHL) * 1317 OH * 1318 OH * 1319 OH * 1320 (OH*OHL)	
				1517 OH * 1518 OH * 1519 OH * 1520 OH * 1521 OH	
1621 L (OH) * 1623 LG (OH) * 1625 (OH) * 1625 L (OH) * 1628 L (OH) * 1630L (OH) * 1635 (OH) * 1636 L (OH)					
1721 L (OH) 370 RS*RSD*RST* ST*U*UP (O) * 371 RS*RSD*RST* ST*U*UP (O)					













Fersa®			Brand / Marca / Marca	Model / Modelo / Modelo	Application / Aplicação / Aplicaciones					
6206 C3	BB		MERCEDES BENZ	1113 (L*LA*LAK*LAS*LK*LP*LS*LP) * 1114 * 1114 (L*LK*LP) * 1116 (L*LA*LAK*LAS*LB*LK*LS) * 1118 (L*LK*LP)	Motor / Motor / Engine					
				1113 OF * 1115 OF						
				1214 C * 1214 K * 1214 (L*LK*LS) * 1215 * 1215 C * 1215 (L*LA*LK) * 1218 * 1218 R (L)						
				1215 OF * 1217 OF						
				1313 (L*LA*LAK*LB*LK*LS) * 1314 (L*LA*LAK*LB*LK*LS) * 1316 (L*LA*LAK*LAS*LB*LK*LS) * 1317 (L*LA*LAK*LK*LS)* 1319 (L)						
				1313 OF * 1314 OF * 1315 OF * 1316 OF * 1317 OF * 1318 OF * 1319 OF * 1320 OF						
				1513 (L*LA*LAK*LB*LG*LK*LS) * 1514 (L*LK*LS) * 1516 (L*LA*LAK*LB*LG*LK*LS) * 1517 (L*LK) * 1518 (L*LK*LS) * 1519 (L*LAK*LB*LG*LK*LS) * 1520 (L*LK*LP*LPK*LPS*LS) * 1521 L * 1524 e 1525 (L*LK*LS)						
				1517 OF * 1518 OF * 1520 OF						
				1614 * 1615 (L*LK*LS) * 1615 * 1618 M * 1618 (L*LK*LS) * 1619 (L)						
				1618 OF						
				1620(L*LK*LS) * 1620 6X2 51 (L) * 1621 (L*LK*LS) * 1622(L*LK*LS) * 1623 (L*LS) * 1625(L*LK*LS) * 1630 (L*LK*LS) * 1632 (L*LS) * 1633(L*LK*LS) * 1634 (L*LS) * 1635 L						
				1620 OF * 1621 OF						
				1714 OF * 1721 OF * 1722 OF						
				1714 * 1714 (L*K*LK) * 1715 * 1718 * 1718 (A * AK) * K * 1720 L * 1721 * 1721 S * 1721 (L*LK) * 1722 S * 1723 * 1723 S * 1725 L						
				1819 (L*LAK*LB*LG*LK*LS) * 1820 LG						
				1924 (LS) * 1924 A (LS) * 1929 (L*LK*LS) * 1930 (LS) * 1932 (LS) * 1933 (LS) * 1934 (LS) * 1935 (L*LS) * 1938 * 1938 S * 1938 (L*LS) * 1941 (L*LS) * 1944 S * 1945 (L*LS)						
				2013 (L*LA*LAK*LB*LG*LK*LS) * 2013 6X2 (L) * 2014 (L*LB*LK) * 2016 (LB*LK) * 2017 (L*LB*LK)						
				2213 (L*LB*LK*LS) * 2213 6X6 (LA) * 2214 * 2215 (L*LB*LK*LS) * 2216 (L*LA*LAK*LB*LG*LK*LS) * 2217 (L*LB*LK*LS) * 2219 (L*LA*LAK*LB*LG*LK*LS) * 2220 * 2222 * 2225 (L*LB*LK*LS)						
				2314 (L*LB*LK*LS) * 2318 (L*LB*LK*LS) * 2325 (L*LB*LK*LS)						
				2414 (6X4) * 2414 (L) * 2418 (L*LB*LK) * 2420 (L*LB*LK) * 2423 B 6X4 * 2423 K 6X4 * 2425 6X6 (LA) * 2425 (L*LB*LK) * 2428 6X4						
				6206 NR		BB		GENERAL MOTORS	Caravan * Opala	Câmbio / Caja de Cambios / Gearbox
									Chevette* Chevy 500 * Marajó (1.0 * 1.4 * 1.6)	
									Marajó (1.0 * 1.4 * 1.6)	
6206 NR 2RS	BB		GENERAL MOTORS	Caravan * Opala	Câmbio / Caja de Cambios / Gearbox					
				Chevette * Chevette Junior * Chevy 500 * Marajó						
6206 Z	BB		AGCO MAXION	Tratores MF (50X * 55X * 65R * 65X * 85 * 85X * 95 * 95X)	Acionador da Polia / Accionador de Polea / Drive Pulley					
			VALTRA - VALMET	Tratores 360 D * 600 D * 621 ID	Tomada de Potência / Toma de Potencia / Power Take-off					
6206 ZZ	BB		AGRALE	Tratores 4100 * 4200 * 4300 * T145 * T146 * T415 * T420	Câmbio / Caja de Cambios / Gearbox					
			TOYOTA	Bandeirante	Motor / Motor / Engine					
6206 ZZ / C3	BB		FIAT	190 (77...)	Embreagem / Embraque / Clutch					
				Motor / Motor / Engine						
6207	BB		VOLVO	B 58	Motor / Motor / Engine					
				B 58 BR (...Chassi 304120)						
			FIAT	180 C * C3 * L * N * N3 (71...)						
				FNM D-11000 (58...72)						
				FNM V-15 (69...74)						
			VALTRA - VALMET	AGRALE		Tratores 4100 * 4200 * 4300 * T145 * T146 * T415 * T420	Redução / Reducción / Reduction			
				FNH		Tratores 4600 * 4610 * 4630 * 5600 * 5610 * 5630 * 6600 * 6610 * 6630 * 7610 * 7630 * 7810 * 7830 * 8030 * 8BR	Tomada de Força / Toma de Fuerza / Power Take-off			
						Tratores 1280 * 1284 * 1580 * 1780 * 1780 (4x4) * 1380 * 1680 * 1880 * 118 * 128 * 138 * 148 * 148 (4x4)	Câmbio / Caja de Cambios / Gearbox			
	Tratores 685 * 685C (4x4) * 785 * 785C (4x4) * 880 Cafeeiro * 880 (4x4) * 885 * 980 (4x4) * 985 * 985F * 1180 * 1184			Eixo Cardan / Eje Cardan / Cardan Shaft						
		Tratores 870 CN * CK	Câmbio / Caja de Cambios / Gearbox							

















Fersa®			Brand / Marca / Marca	Model / Modelo / Modelo	Application / Aplicação / Aplicaciones	
6207 2RS	BB		AGCO MAXION	Colheteira Combinada Automotriz 1170DS * 1175DS * 1630 Arroeira * 3640 Arroeira * 5650 * MF 220A * 220CBD * 220STD * MF 310CBD * 310STD * 210 * 210S * 220 * 310	Embreagem / Embrague / Clutch	
				Tanque de Grãos / Tanque de Granos / Grain Tank		
			FNH	Colheteiras 4040 * 5030 * 5050 * 8040 * 8055 * TC55 * TC57 * CA1530	Variador de Tração / Variador de Tracción / Traction Variable Drive	
				Todos / Todos / All	Motor / Motor / Engine	
6207 2RS / C3	BB	References Fersa with Multiple Applications / Referências Fersa com Múltiplas Aplicações / Referencias Fersa con Múltiples Aplicaciones				
6207 C3	BB		VOLKSWAGEN	Kombi (1500 * 1600)	Eixo Traseiro / Eje Trasero / Rear Axle	
				SCANIA	101 (L*LS) * 111 (B) * 111 Articulado (B)	Motor / Motor / Engine
		110 (B)				
		110 (L*LS)				
		111 (L*LS*LT)				
		115 * 116 BR				
		140 (LK*LKS)				
			SCANIA	K 94 IB (4X2)	Tomada de Força / Toma de Fuerza / Power Take-off	
				P 93 * R 113 * R 143* T 113	Motor / Motor / Engine	
				FIAT		FNM D-9500 (50...57)
				SCANIA	112 (F*K*S)	Tomada de Força / Toma de Fuerza / Power Take-off
					75 * 76 B*L*LS	
					F 113 * L 113 * K 113	Motor / Motor / Engine
					P 94 CB (4x2 * 6x2 * 6X4)	Tomada de Força / Toma de Fuerza / Power Take-off
P 94 GA*GB (4X2)	Motor / Motor / Engine					
R 112 (81...)	Tomada de Força / Toma de Fuerza / Power Take-off					
R 142 MA (4X2)(81...)						
T 142 E (6X4)	Motor / Motor / Engine					
6207 NR	BB		SCANIA	K 94 IB (4X2)	Motor / Motor / Engine	
			SCANIA	75 * 76 B*L*LS		
				P 94 CB (4x2 * 6x2 * 6X4)		
P 94 GA*GB (4X2)						
6207 NR 2RS	BB		GENERAL MOTORS	Caravan * Opala	Câmbio / Caja de Cambios / Gearbox	
				Chevette * Chevette Junior * Chevy 500 * Marajó		
6207 Z	BB		FNH	Colheteiras 4040 * 5030 * 5050 * 8040 * 8055 * TC55 * TC57 * CA1530	Picador de Palha / Picador de Paja / Straw Chopper	
6207 ZN / C3	BB		GENERAL MOTORS	Silverado	Câmbio / Caja de Cambios / Gearbox	
6207 ZNR	BB		FORD	Sierra (L* XR3 * S)	Câmbio / Caja de Cambios / Gearbox	
6207 ZZ	BB		VALTRA - VALMET	Tratores 60 * 60 ID * 62 * 65 * 65 Cafeeiro * 68 * 68 Cafeeiro * 78 * 80 * M80 * 85 * 85ID * 86 * 86 ID * 88 * 88 ID	Conjunto da Polia / Conjunto de Polea / Pulley Assembly	
				Tratores 360 D * 600 D * 621 ID	Embreagem / Embrague / Clutch	
				Tratores 685 * 685C (4x4) * 785 * 785C (4x4) * 880 Cafeeiro * 880 (4x4) * 885 * 980 (4x4) * 985 * 985F * 1180 * 1184	Redução / Reducción / Reduction	











Fersa®			Brand / Marca / Marca	Model / Modelo / Modelo	Application / Aplicação / Aplicaciones
6208	BB		SCANIA	K 94 IB (4X2)	Tomada de Força / Toma de Fuerza / Power Take-off
			MERCEDES BENZ	1018 MBO	Cardan / Cardan / Cardan
				1111 (L*LA*LAK* LAS*LK*LS)	
				312 (L*LK*LP) 51...58	
				331 (L*LPK*LPS) 60...68	Cardan / Cardan / Cardan Tomada de Potência / Toma de Potencia / Power Take-off
		SCANIA	75 * 76 B*L*LS	Tomada de Força / Toma de Fuerza / Power Take-off	
			P 94 CB (4x2 * 6x2 * 6X4) P 94 GA*GB (4X2)		
			MERCEDES BENZ	1018 MBO	Cardan / Cardan / Cardan
			AGCO MAXION	Colhetadeira Combinada Automotriz 1170DS * 1175DS * 1630 Arroeira * 3640 Arroeira * 5650 * MF 220A * 220CBD * 220STD * MF 310CBD * 310STD * 210 * 210S * 220 * 310	Câmbio / Caja de Cambios / Gearbox
				FNH	Colheitadeiras 4040 * 5030 * 5050 * 8040 * 8055 * TC55 * TC57 * CA1530
6208 2RS	BB		AGCO MAXION	Colhetadeira Combinada Automotriz 1170DS * 1175DS * 1630 Arroeira * 3640 Arroeira * 5650 * MF 220A * 220CBD * 220STD * MF 310CBD * 310STD * 210 * 210S * 220 * 310	Motor / Motor / Engine Tanque de Grãos / Tanque de Granos / Grain Tank
				FNH	Colheitadeiras 4040 * 5030 * 5050 * 8040 * 8055 * TC55 * TC57 * CA1530
			ASIA	Topic	Câmbio / Caja de Cambios / Gearbox
6208 2RS / C3	BB	References Fersa with Multiple Applications / Referências Fersa com Múltiplas Aplicações / Referencias Fersa con Multiples Aplicaciones			
6208 N	BB		MERCEDES BENZ	1418 OH * 1419 OH * 1420 (OH*OHL) * 1421 OHL	Caixa de Mudanças / Caja de Cambios / Gearbox Tomada de Potência / Toma de Potencia / Power Take-off
				1517 OH * 1518 OH * 1519 OH * 1520 OH * 1521 OH	Caixa de Mudanças / Caja de Cambios / Gearbox
				1621 L (OH) * 1623 LG (OH) * 1625 (OH) * 1625 L (OH) * 1628 L (OH) * 1630L (OH) * 1635 (OH) * 1636 L (OH)	Tomada de Força / Toma de Fuerza / Power Take-off
				1721 L (OH)	Caixa de Mudanças / Caja de Cambios / Gearbox
				1214 C * 1214 K * 1214 (L*LK*LS) * 1215 * 1215 C * 1215 (L*LA*LK) * 1218 * 1218 R (L) 1215 OF * 1217 OF	
				1414 * 1414 (K*L*LA*LAK*LK) * 1418 * 1418 (E*K*R) * 1418 (L*LA*LAK*LK*R(LK)) * 1419 (L*LK*LS) * 1420 (L*LK*LS)	
			MERCEDES BENZ	1417 OF * 1419 OF * 1421 OF	Caixa de Mudanças / Caja de Cambios / Gearbox Tomada de Potência / Toma de Potencia / Power Take-off
				1421 OMC	Caixa de Mudanças / Caja de Cambios / Gearbox Tomada de Potência / Toma de Potencia / Power Take-off
				1513 (L*LA*LAK*LB*LG*LK*LS) * 1514 (L*LK*LS) * 1516 (L*LA*LAK*LB*LG*LK*LS) * 1517 (L*LK) * 1518 (L*LK*LS) * 1519 (L*LAK*LB*LG*LK*LS) * 1520 (L*LK*LP*LPK*LPS*LS) * 1521 L * 1524 e 1525 (L*LK*LS)	Caixa de Mudanças / Caja de Cambios / Gearbox
				1517 OF * 1518 OF * 1520 OF	Tomada de Potência / Toma de Potencia / Power Take-off
				1614 * 1615 (L*LK*LS) * 1615 * 1618 M * 1618 (L*LK*LS) * 1619 (L)	
				1618 OF	





Fersa*			Brand / Marca / Marca	Model / Modelo / Modelo	Application / Aplicação / Aplicaciones	
6208 N	BB		MERCEDES BENZ	1620(L*LK*LS) * 1620 6X2 51 (L) * 1621 (L*LK*LS) * 1622(L*LK*LS) * 1623 (L*LS) * 1625(L*LK*LS) * 1630 (L*LK*LS) * 1632 (L*LS) * 1633(L*LK*LS) * 1634 (L*LS) * 1635 L	Caixa de Mudanças / Caja de Cambios / Gearbox Tomada de Força / Toma de Fuerza / Power Take-off	
				1620 OF * 1621 OF	Caixa de Mudanças / Caja de Cambios / Gearbox Tomada de Força / Toma de Fuerza / Power Take-off	
				1714 OF * 1721 OF * 1722 OF		
				1714 * 1714 (L*K*LK) * 1715 * 1718 * 1718 (A * AK) * K * 1720 L * 1721 * 1721 S * 1721 (L*LK) * 1722 S * 1723 * 1723 S * 1725 L	Caixa de Mudanças / Caja de Cambios / Gearbox	
				1924 (LS) * 1924 A (LS) * 1929 (L*LK*LS) * 1930 (LS) * 1932 (LS) * 1933 (LS) * 1934 (LS) * 1935 (L*LS) * 1938 * 1938 S * 1938 (L*LS) * 1941 (L*LS) * 1944 S * 1945 (L*LS)	Tomada de Força / Toma de Fuerza / Power Take-off Tomada de Potência / Toma de Potencia / Power Take-off	
				2213 (L*LB*LK*LS) * 2213 6X6 (LA) * 2214 * 2215 (L*LB*LK*LS) * 2216 (L*LA*LAK*LB*LG*LK*LS) * 2217 (L*LB*LK*LS) * 2219 (L*LA*LAK*LB*LG*LK*LS) * 2220 * 2222 * 2225 (L*LB*LK*LS)	Tomada de Força / Toma de Fuerza / Power Take-off Tomada de Potência / Toma de Potencia / Power Take-off	
				2414 (6X4) * 2414 (L) * 2418 (L*LB*LK) * 2420 (L*LB*LK) * 2423 B 6X4 * 2423 K 6X4 * 2425 6X6 (LA) * 2425 (L*LB*LK) * 2428 6X4	Tomada de Força / Toma de Fuerza / Power Take-off	
				2629 LS	Caixa de Mudanças / Caja de Cambios / Gearbox	
				VOLVO	N * NL 10 BR * N * NL 12 BR * N 10BR Mark II * NL 10BR 6x2	Tomada de Força / Toma de Fuerza / Power Take-off
				MERCEDES BENZ	1215 OF * 1217 OF	Caixa de Mudanças / Caja de Cambios / Gearbox
					1417 OF * 1419 OF * 1421 OF	
					1421 OMC	
					1517 OF * 1518 OF * 1520 OF	
					1618 OF	
1620 OF * 1621 OF						
1714 OF * 1721 OF * 1722 OF						
6208 ZZ	BB		AGCO MAXION	Tratores MF (50X * 55X * 65R * 65X * 85 * 85X * 95 * 95X)	Câmbio / Caja de Cambios / Gearbox	
			AGRALE	Tratores 4100 * 4200 * 4300 * T145 * T146 * T415 * T420	Redução / Reducción / Reduction Tomada de Força / Toma de Fuerza / Power Take-off	
			VALTRA - VALMET	Tratores 360 D * 600 D * 621 ID	Câmbio / Caja de Cambios / Gearbox	
			ALFA ROMEO	Alfa 2300	Eixo Traseiro / Eje Trasero / Rear Axle	
6209	BB		VOLVO	B 58 B 58 BR (...Chassi 304120)	Convertor de Par / Convertor de Par / Torque Converter	
			FIAT	180 C * C3 * L * N * N3 (71...)	Embreagem / Embrague / Clutch	
		FNM 210 C * CM * LN (71...76)				
		FNM D-11000 (58...72) FNM V-15 (69...74)				
			CBT	Tratores 8060 (4x2) * 8060 (4x4) * 8240 * 8240A * 8260 * 8440 * 8450	Tomada de Potência / Toma de Potencia / Power Take-off	
			FNH	Tratores 4600 * 4610 * 4630 * 5600 * 5610 * 5630 * 6600 * 6610 * 6630 * 7610 * 7630 * 7810 * 7830 * 8030 * 8BR	Tomada de Força / Toma de Fuerza / Power Take-off	
			LADA	Niva	Caixa de transferência / Caja de Transferencia / Transfer Case	
		6209 2RS	BB		AGCO MAXION	Colheteira Combinada Automotriz 1170DS * 1175DS * 1630 Arrozadeira * 3640 Arrozadeira * 5650 * MF 220A * 220CBD * 220STD * MF 310CBD * 310STD * 210 * 210S * 220 * 310







Fersa®			Brand / Marca / Marca	Model / Modelo / Modelo	Application / Aplicação / Aplicaciones	
6209 2RS	BB		AGCO MAXION	2070 * 2080 * 2100 * 2105 (4x2) * 2400 * 2400 (4x4) * 2500 * 2600 Tratores 8060 (4x2) * 8060 (4x4) * 8240 * 8240A * 8260 * 8440 * 8450	Eixo Traseiro / Eje Trasero / Rear Axle	
6209 C3	BB		MERCEDES BENZ	1517 OF * 1518 OF * 1520 OF	Caixa de Mudanças / Caja de Cambios / Gearbox	
			MERCEDES BENZ	1517 OH * 1518 OH * 1519 OH * 1520 OH * 1521 OH	Caixa de Mudanças / Caja de Cambios / Gearbox	
			MERCEDES BENZ	1621 L (OH) * 1623 LG (OH) * 1625 (OH) * 1625 L (OH) * 1628 L (OH) * 1630L (OH) * 1635 (OH) * 1636 L (OH)	Tomada de Força / Toma de Fuerza / Power Take-off	
			MERCEDES BENZ	1513 (L*LA*LAK*LB*LG*LK*LS) * 1514 (L*LK*LS) * 1516 (L*LA*LAK*LB*LG*LK*LS) * 1517 (L*LK) * 1518 (L*LK*LS) * 1519 (L*LAK*LB*LG*LK*LS) * 1520 (L*LK*LP*LPK*LPS*LS) * 1521 L * 1524 e 1525 (L*LK*LS)	Caixa de Mudanças / Caja de Cambios / Gearbox	
			MERCEDES BENZ	1517 OF * 1518 OF * 1520 OF		
			MERCEDES BENZ	1614 * 1615 (L*LK*LS) * 1615 * 1618 M * 1618 (L*LK*LS) * 1619 (L)	Tomada de Potência / Toma de Potencia / Power Take-off	
			MERCEDES BENZ	1618 OF		
			MERCEDES BENZ	1620(L*LK*LS) * 1620 6X2 51 (L) * 1621 (L*LK*LS) * 1622(L*LK*LS) * 1623 (L*LS) * 1625(L*LK*LS) * 1630 (L*LK*LS) * 1632 (L*LS) * 1633(L*LK*LS) * 1634 (L*LS) * 1635 L	Tomada de Força / Toma de Fuerza / Power Take-off	
			MERCEDES BENZ	1620 OF * 1621 OF		
			MERCEDES BENZ	2213 (L*LB*LK*LS) * 2213 6X6 (LA) * 2214 * 2215 (L*LB*LK*LS) * 2216 (L*LA*LAK*LB*LG*LK*LS) * 2217 (L*LB*LK*LS) * 2219 (L*LA*LAK*LB*LG*LK*LS) * 2220 * 2222 * 2225 (L*LB*LK*LS)	Tomada de Potência / Toma de Potencia / Power Take-off	
MERCEDES BENZ	2314 (L*LB*LK*LS) * 2318 (L*LB*LK*LS) * 2325 (L*LB*LK*LS)	Tomada de Força / Toma de Fuerza / Power Take-off Tomada de Potência / Toma de Potencia / Power Take-off				
6209 NR	BB		LADA	Niva	Caixa de transferência / Caja de Transferencia / Transfer Case	
6209 NR / C3	BB		TOYOTA	Bandeirante	Câmbio / Caja de Cambios / Gearbox	
6209 ZZ	BB		VOLVO	B 10M BR	Cardan / Cardan / Cardan	
				B 10R * B 12B * B 12R * B 58 * B 58BR * B 7R * B9		
				B 58		
				B 58 BR (...Chassi 304120)		
6210	BB		MERCEDES BENZ	1517 OH * 1518 OH * 1519 OH * 1520 OH * 1521 OH	Cardan / Cardan / Cardan	
				MERCEDES BENZ	1621 L (OH) * 1623 LG (OH) * 1625 (OH) * 1625 L (OH) * 1628 L (OH) * 1630L (OH) * 1635 (OH) * 1636 L (OH)	
			MERCEDES BENZ	MERCEDES BENZ	1513 (L*LA*LAK*LB*LG*LK*LS) * 1514 (L*LK*LS) * 1516 (L*LA*LAK*LB*LG*LK*LS) * 1517 (L*LK) * 1518 (L*LK*LS) * 1519 (L*LAK*LB*LG*LK*LS) * 1520 (L*LK*LP*LPK*LPS*LS) * 1521 L * 1524 e 1525 (L*LK*LS)	Cardan / Cardan / Cardan
				MERCEDES BENZ	1517 OF * 1518 OF * 1520 OF	
				MERCEDES BENZ	1614 * 1615 (L*LK*LS) * 1615 * 1618 M * 1618 (L*LK*LS) * 1619 (L)	
				MERCEDES BENZ	1618 OF	
				MERCEDES BENZ	1620(L*LK*LS) * 1620 6X2 51 (L) * 1621 (L*LK*LS) * 1622(L*LK*LS) * 1623 (L*LS) * 1625(L*LK*LS) * 1630 (L*LK*LS) * 1632 (L*LS) * 1633(L*LK*LS) * 1634 (L*LS) * 1635 L	
				MERCEDES BENZ	1620 OF * 1621 OF	
				MERCEDES BENZ	331 (L*LPK*LPS) 60...68	
				MERCEDES BENZ	1517 OF * 1518 OF * 1520 OF	
			MERCEDES BENZ	1618 OF	Cardan / Cardan / Cardan	
			MERCEDES BENZ	1620 OF * 1621 OF		
			AGRALE	Tratores 4100 * 4200 * 4300 * T145 * T146 * T415 * T420	Eixo Traseiro / Eje Trasero / Rear Axle	
			CBT	Tratores 8060 (4x2) * 8060 (4x4) * 8240 * 8240A * 8260 * 8440 * 8450	Tomada de Potência / Toma de Potencia / Power Take-off	
	VALTRA - VALMET	FNH	Tratores 4600 * 4610 * 4630 * 5600 * 5610 * 5630 * 6600 * 6610 * 6630 * 7610 * 7630 * 7810 * 7830 * 8030 * 8BR	Câmbio / Caja de Cambios / Gearbox		
		VALTRA - VALMET	Tratores 60 * 60 ID * 62 * 65 * 65 Cafeeiro * 68 * 68 Cafeeiro * 78 * 80 * M80 * 85 * 85ID * 86 * 86 ID * 88 * 88 ID Tratores 110 ID * 110ID II * 118 * 118 (4x4) * 128 * 128 (4x4)	Conjunto da Polia / Conjunto de Polea / Pulley Assembly Tomada de Potência / Toma de Potencia / Power Take-off		













Fersa®			Brand / Marca / Marca	Model / Modelo / Modelo	Application / Aplicação / Aplicaciones
6210	BB		VALTRA - VALMET	Tratores 110 ID * 110ID II * 118 * 118 (4x4) * 128 * 128 (4x4)	Super - Redução / Super - Reducción / Super - Reduction
				Tratores 1280 * 1284 * 1580 * 1780 * 1780 (4x4) * 1380 * 1680 * 1880 * 118 * 128 * 138 * 148 * 148 (4x4)	Redução / Reducción / Reduction Tomada de Potência / Toma de Potencia / Power Take-off
				Tratores 685 * 685C (4x4) * 785 * 785C (4x4) * 880 Cafeeiro * 880 (4x4) * 885 * 980 (4x4) * 985 * 985F * 1180 * 1184	Conjunto da Polia / Conjunto de Polea / Pulley Assembly Tomada de Potência / Toma de Potencia / Power Take-off
				Tratores 870 CN * CK	Super - Redução / Super - Reducción / Super - Reduction
6210 2RS	BB		AGCO MAXION	Colhedeira Combinada Automotriz 1170DS * 1175DS * 1630 Arroeira * 3640 Arroeira * 5650 * MF 220A * 220CBD * 220STD * MF 310CBD * 310STD * 210 * 210S * 220 * 310	Diferencial / Diferencial / Differential Embreagem / Embrague / Clutch
			FNH	Colheitadeiras 4040 * 5030 * 5050 * 8040 * 8055 * TC55 * TC57 * CA1530	Plataforma Dianteira / Plataforma Delantera / Front Platform Embreagem / Embrague / Clutch
			VALTRA - VALMET	Tratores 685 * 685C (4x4) * 785 * 785C (4x4) * 880 Cafeeiro * 880 (4x4) * 885 * 980 (4x4) * 985 * 985F * 1180 * 1184	Tomada de Potência / Toma de Potencia / Power Take-off
6210 Z	BB		AGCO MAXION	Diversos	Câmbio / Caja de Cambios / Gearbox
6210 ZZ	BB		FNH	Colheitadeiras 4040 * 5030 * 5050 * 8040 * 8055 * TC55 * TC57 * CA1530	Embreagem / Embrague / Clutch
6210 ZZ NR	BB	References Fersa with Multiple Applications / Referências Fersa com Múltiplas Aplicações / Referencias Fersa con Multiples Aplicaciones			
6211	BB		SCANIA	101 (L*LS) * 111 (B) * 111 Articulado (B)	Cardan / Cardan / Cardan
				110 (B)	
				110 (L*LS)	
				111 (L*LS*LT)	
				115 * 116 BR	
				140 (LK*LKS)	
				K 94 IB (4X2)	
	P 93 * R 113 * R 143* T 113				
	BB		SCANIA	112 (F*K*S)	Cardan / Cardan / Cardan
				75 * 76 B*L*LS	
F 113 * L 113 * K 113					
BB		AGRALE	Tratores 4100 * 4200 * 4300 * T145 * T146 * T415 * T420	Eixo Traseiro / Eje Trasero / Rear Axle	
			FNH	Todos / Todos / All	Câmbio / Caja de Cambios / Gearbox
6211 2RS	BB		AGCO MAXION	Colhedeira Combinada Automotriz 1170DS * 1175DS * 1630 Arroeira * 3640 Arroeira * 5650 * MF 220A * 220CBD * 220STD * MF 310CBD * 310STD * 210 * 210S * 220 * 310	Tomada de Potência / Toma de Potencia / Power Take-off
6211 C3	BB		VOLVO	B 58	Conversor de Par / Conversor de Par / Torque Converter Embreagem / Embrague / Clutch
				B 58 BR (...Chassi 304120)	Conversor de Par / Conversor de Par / Torque Converter Embreagem / Embrague / Clutch
		MERCEDES BENZ	1819 (L*LAK*LB*LG*LK*LS) * 1820 LG	Eixo Traseiro / Eje Trasero / Rear Axle	
			2213 (L*LB*LK*LS) * 2213 6X6 (LA) * 2214 * 2215 (L*LB*LK*LS) * 2216 (L*LA*LAK*LB*LG*LK*LS) * 2217 (L*LB*LK*LS) * 2219 (L*LA*LAK*LB*LG*LK*LS) * 2220 * 2222 * 2225 (L*LB*LK*LS)		







Fersa®			Brand / Marca / Marca	Model / Modelo / Modelo	Application / Aplicação / Aplicaciones
6211 C3	BB		MERCEDES BENZ	2314 (L*LB*LK*LS) * 2318 (L*LB*LK*LS) * 2325 (L*LB*LK*LS) 2414 (6X4) * 2414 (L) * 2418 (L*LB*LK) * 2420 (L*LB*LK) * 2423 B 6X4 * 2423 K 6X4 * 2425 6X6 (LA) * 2425 (L*LB*LK) * 2428 6X4	Eixo Traseiro / Eje Trasero / Rear Axle
6211 N / C3	BB		MERCEDES BENZ	1313 OH * 1314 OH * 1315 OH * 1316 (OH*OHL) * 1316 G (OH*OHL) * 1317 OH * 1318 OH * 1319 OH * 1320 (OH*OHL)	Caixa de Mudanças / Caja de Cambios / Gearbox
			MERCEDES BENZ	1313 (L*LA*LAK*LB*LK*LS) * 1314 (L*LA*LAK*LB*LK*LS) * 1316 (L*LA*LAK*LAS*LB*LK*LS) * 1317 (L*LA*LAK*LK*LS) * 1319 (L)	
				1313 OF * 1314 OF * 1315 OF * 1316 OF * 1317 OF * 1318 OF * 1319 OF * 1320 OF	
				1819 (L*LAK*LB*LG*LK*LS) * 1820 LG 2213 (L*LB*LK*LS) * 2213 6X6 (LA) * 2214 * 2215 (L*LB*LK*LS) * 2216 (L*LA*LAK*LB*LG*LK*LS) * 2217 (L*LB*LK*LS) * 2219 (L*LA*LAK*LB*LG*LK*LS) * 2220 * 2222 * 2225 (L*LB*LK*LS)	
	MERCEDES BENZ	2314 (L*LB*LK*LS) * 2318 (L*LB*LK*LS) * 2325 (L*LB*LK*LS) 2414 (6X4) * 2414 (L) * 2418 (L*LB*LK) * 2420 (L*LB*LK) * 2423 B 6X4 * 2423 K 6X4 * 2425 6X6 (LA) * 2425 (L*LB*LK) * 2428 6X4			
6211 Z	BB		AGCO MAXION	Tratores MF 235 (4x4) Antigo * MF 235 Moderno * 250 * 265 * MF265 RD * 270 * 274 * 275 * 285 * 290 * MF 292 (4x4) * 295 * 296 * 299 Tratores MF (50X * 55X * 65R * 65X * 85 * 85X * 95 * 95X)	Câmbio / Caja de Cambios / Gearbox
6211 ZNR	BB		DODGE	400 * 450 * 700 * 750 * 900 * 950	Caixa de Mudanças / Caja de Cambios / Gearbox
			FORD	Cargo 814	
				Cargo 815 * 815 E F 100 (61...80 Diesel) * F 600 (56...77 Gas.) * F 700 (77...80) * F 750 (72...77) * 750 * 2000 * 4000	
		GENERAL MOTORS	A-C-D 60* 70* 80* 90* 99 Turbo e 3500 Heavy Duty		
	AGCO MAXION	Colhedeira Combinada Automotriz 1170DS * 1175DS * 1630 Arroeira * 3640 Arroeira * 5650 * MF 220A * 220CBD * 220STD * MF 310CBD * 310STD * 210 * 210S * 220 * 310 Tratores MF (50X * 55X * 65R * 65X * 85 * 85X * 95 * 95X)	Câmbio / Caja de Cambios / Gearbox		
	CBT	Tratores 1000 * 1000 (4x4) * 1020 * 1020 (4x4) * 1065 * 1065 (4x4) * 1090 * 1105	Tomada de Potência / Toma de Potencia / Power Take-off		
6212	BB		SCANIA	140 (LK*LKS)	Cardan / Cardan / Cardan Embreagem / Embrague / Clutch
			FIAT	FNM D-11000 (58...72)	Cardan / Cardan / Cardan
		SCANIA		FNM D-9500 (50...57)	Embreagem / Embrague / Clutch
			112 (F*K*S) R 112 (81...)	Cardan / Cardan / Cardan Embreagem / Embrague / Clutch	
			R 142 MA (4X2)(81...)	Cardan / Cardan / Cardan Embreagem / Embrague / Clutch	
			FNH	Todos / Todos / All	Câmbio / Caja de Cambios / Gearbox
6212 2RS	BB		AGCO MAXION	Colhedeira Combinada Automotriz 1170DS * 1175DS * 1630 Arroeira * 3640 Arroeira * 5650 * MF 220A * 220CBD * 220STD * MF 310CBD * 310STD * 210 * 210S * 220 * 310	Variador de Tração / Variador de Tracción / Traction Variable Drive
6212 NR	BB		CBT	2070 * 2080 * 2100 * 2105 (4x2) * 2400 * 2400 (4x4) * 2500 * 2600 Tratores 1000 * 1000 (4x4) * 1020 * 1020 (4x4) * 1065 * 1065 (4x4) * 1090 * 1105	Tomada de Potência / Toma de Potencia / Power Take-off
				Tratores 8060 (4x2) * 8060 (4x4) * 8240 * 8240A * 8260 * 8440 * 8450	Limitador de Torque / Limitador de Par / Torque Limiter
6212 ZNR	BB		FIAT	190 (77...)	Caixa de Mudanças / Caja de Cambios / Gearbox
6213 C3	BB		MERCEDES BENZ	1714 OF * 1721 OF * 1722 OF	Caixa de Mudanças / Caja de Cambios / Gearbox
			MERCEDES BENZ	1721 L (OH)	
			MERCEDES BENZ	1714 OF * 1721 OF * 1722 OF 1714 * 1714 (L*K*LK) * 1715 * 1718 * 1718 (A * AK) * K * 1720 L * 1721 * 1721 S * 1721 (L*LK) * 1722 S * 1723 * 1723 S * 1725 L	









Fersa*			Brand / Marca / Marca	Model / Modelo / Modelo	Application / Aplicação / Aplicaciones				
6213 C3	BB		MERCEDES BENZ	1924 (LS) * 1924 A (LS) * 1929 (L*LK*LS) * 1930 (LS) * 1932 (LS) * 1933 (LS) * 1934 (LS) * 1935 (L*LS) * 1938 * 1938 S * 1938 (L*LS) * 1941 (L*LS) * 1944 S * 1945 (L*LS) 2629 LS	Caixa de Mudanças / Caja de Cambios / Gearbox				
6214	BB		FIAT	180 C * C3 * L * N * N3 (71...) 70 (77...) * 80	Cardan / Cardan / Cardan				
6215 C3	BB		SCANIA	T 142 E (6X4)	Caixa de Mudanças / Caja de Cambios / Gearbox				
6215 NR / C3	BB		SCANIA	110 (B)	Caixa de Mudanças / Caja de Cambios / Gearbox				
				110 (L*LS)					
				111 (L*LS*LT)					
				140 (LK*LKS)					
SCANIA	R 112 (81...)								
	R 142 MA (4X2)(81...)								
6216 C3	BB		MERCEDES BENZ	2635 (L*LK*LS)	Eixo Traseiro / Eje Trasero / Rear Axle				
6218 C3	BB		MERCEDES BENZ	1618 OF	Caixa de Mudanças / Caja de Cambios / Gearbox				
				1620 OF * 1621 OF 1714 OF * 1721 OF * 1722 OF					
			MERCEDES BENZ	1621 L (OH) * 1623 LG (OH) * 1625 (OH) * 1625 L (OH) * 1628 L (OH) * 1630L (OH) * 1635 (OH) * 1636 L (OH) 1721 L (OH)					
				MERCEDES BENZ		1614 * 1615 (L*LK*LS) * 1615 * 1618 M * 1618 (L*LK*LS) * 1619 (L) 1618 OF 1620(L*LK*LS) * 1620 6X2 51 (L) * 1621 (L*LK*LS) * 1622(L*LK*LS) * 1623 (L*LS) * 1625(L*LK*LS) * 1630 (L*LK*LS) * 1632 (L*LS) * 1633(L*LK*LS) * 1634 (L*LS) * 1635 L 1620 OF * 1621 OF 1714 OF * 1721 OF * 1722 OF 1714 * 1714 (L*K*LK) * 1715 * 1718 * 1718 (A * AK) * K * 1720 L * 1721 * 1721 S * 1721 (L*LK) * 1722 S * 1723 * 1723 S * 1725 L 1924 (LS) * 1924 A (LS) * 1929 (L*LK*LS) * 1930 (LS) * 1932 (LS) * 1933 (LS) * 1934 (LS) * 1935 (L*LS) * 1938 * 1938 S * 1938 (L*LS) * 1941 (L*LS) * 1944 S * 1945 (L*LS) 2414 (6X4) * 2414 (L) * 2418 (L*LB*LK) * 2420 (L*LB*LK) * 2423 B 6X4 * 2423 K 6X4 * 2425 6X6 (LA) * 2425 (L*LB*LK) * 2428 6X4			
		Eixo Traseiro / Eje Trasero / Rear Axle							
		62201 2RS / C3	BB				VOLKSWAGEN	23-250	Motor / Motor / Engine
							VOLVO	7550	
								9700	
							MERCEDES BENZ	1113 (LPO*OH) * 1114 LPO * 1115 L (OH) * 1118 LPO 1313 OH * 1314 OH * 1315 OH * 1316 (OH*OHL) * 1316 G (OH*OHL) * 1317 OH * 1318 OH * 1319 OH * 1320 (OH*OHL) 1418 OH * 1419 OH * 1420 (OH*OHL) * 1421 OHL 1517 OH * 1518 OH * 1519 OH * 1520 OH * 1521 OH 1621 L (OH) * 1623 LG (OH) * 1625 (OH) * 1625 L (OH) * 1628 L (OH) * 1630L (OH) * 1635 (OH) * 1636 L (OH) 1721 L (OH) 352 HL (O) (...74) 355 O 362 O 364 O 370 RS*RSD*RST* ST*U*UP (O) * 371 RS*RSD*RST* ST*U*UP (O) 400 (R * RS * RSD * RSL) (O) 500 (O*M* R) 608 D * E (L*LO) * 708 D * E (L*LO) * 709 L * 710 L * 712 L 812 LO * 912 L	
				VOLVO				B 10M BR B 10R * B 12B * B 12R * B 58 * B 58BR * B 7R *B9 B 58 B 58 BR (...Chassi 304120)	
FORD	Cargo 1113 * 1114 * 1116 * 1117 Cargo 1215 Cargo 1313 * 1314 * 1317 * 1317E								











Fersa®			Brand / Marca / Marca	Model / Modelo / Modelo	Application / Aplicação / Aplicaciones	
62201 2RS / C3	BB		FORD	Cargo 1415 * 1416 Cargo 1422 * 1514 * 1517 * 1517E * 1615 * 1615T * 1617 * 1618 * 1618T * 1619 * 1621 * 1622 * 1717E * 1722 * 1722E * 2216 * 2217 * 2218 * 2218T * 2319 * 2322 * 2324 * 2422 * 2422E * 2425 * 2428E * 2630 * 3224 * 3530 * 4030 F 19000 (77...) * F 21000 * F 22000	Motor / Motor / Engine	
			MERCEDES BENZ	608 (L*LO) * 708 (L*LO) * 809 (LO*OF) * 812 (LO*OF) * 814 LO * 817 O * 914 LO * 709 * 710 * 712 * 712 C * 811 * 911 L * 912 * 913 * 914 * 914 C * 917 1113 (L*LA*LAK*LAS*LK*LP*LS*LP) * 1114 * 1114 (L*LK*LP) * 1116 (L*LA*LAK*LAS*LB* LK*LS) * 1118 (L*LK*LP) 1113 OF * 1115 OF 1214 C * 1214 K * 1214 (L*LK*LS) * 1215 * 1215 C * 1215 (L*LA*LK) * 1218 * 1218 R (L) 1215 OF * 1217 OF 1313 (L*LA*LAK*LB*LK*LS) * 1314 (L*LA*LAK*LB*LK*LS) * 1316 (L*LA*LAK*LAS*LB*LK*LS) * 1317 (L*LA*LAK*LK*LS)* 1319 (L) 1313 OF * 1314 OF * 1315 OF * 1316 OF * 1317 OF * 1318 OF * 1319 OF * 1320 OF 1414 * 1414 (K*L*LA*LAK*LK) * 1418 * 1418 (E*K*R) * 1418 (L*LA*LAK*LK*R(LK)) * 1419 (L*LK*LS) * 1420 (L*LK*LS) 1417 OF * 1419 OF * 1421 OF 1421 OMC 1513 (L*LA*LAK*LB*LG*LK*LS) * 1514 (L*LK*LS) * 1516 (L*LA*LAK*LB*LG*LK*LS) * 1517 (L*LK) * 1518 (L*LK*LS) * 1519 (L*LAK*LB*LG*LK*LS) * 1520 (L*LK*LP*LPK*LPS*LS) * 1521 L * 1524 e 1525 (L*LK*LS) 1517 OF * 1518 OF * 1520 OF 1614 * 1615 (L*LK*LS) * 1615 * 1618 M * 1618 (L*LK*LS) * 1619 (L) 1618 OF 1620(L*LK*LS) * 1620 6X2 51 (L) * 1621 (L*LK*LS) * 1622(L*LK*LS) * 1623 (L*LS) * 1625(L*LK*LS) * 1630 (L*LK*LS) * 1632 (L*LS) * 1633(L*LK*LS) * 1634 (L*LS) * 1635 L 1620 OF * 1621 OF 1714 OF * 1721 OF * 1722 OF 1714 * 1714 (L*K*LK) * 1715 * 1718 * 1718 (A * AK) * K * 1720 L * 1721 * 1721 S * 1721 (L*LK) * 1722 S * 1723 * 1723 S * 1725 L 1819 (L*LAK*LB*LG*LK*LS) * 1820 LG 1924 (LS) * 1924 A (LS) * 1929 (L*LK*LS) * 1930 (LS) * 1932 (LS) * 1933 (LS) * 1934 (LS) * 1935 (L*LS) * 1938 * 1938 S * 1938 (L*LS) * 1941 (L*LS) * 1944 S * 1945 (L*LS) 2013 (L*LA*LAK*LB*LG*LK*LS) * 2013 6X2 (L) * 2014 (L*LB*LK) * 2016 (LB*LK) * 2017 (L*LB*LK) 2213 (L*LB*LK*LS) * 2213 6X6 (LA) * 2214 * 2215 (L*LB*LK*LS) * 2216 (L*LA*LAK*LB*LG*LK*LS) * 2217 (L*LB*LK*LS) * 2219 (L*LA*LAK*LB*LG*LK*LS) * 2220 * 2222 * 2225 (L*LB*LK*LS) 2314 (L*LB*LK*LS) * 2318 (L*LB*LK*LS) * 2325 (L*LB*LK*LS) 2414 (6X4) * 2414 (L) * 2418 (L*LB*LK) * 2420 (L*LB*LK) * 2423 B 6X4 * 2423 K 6X4 * 2425 6X6 (LA) * 2425 (L*LB*LK) * 2428 6X4 Axor 2625 * 2628 * 2629 (LK*LS) * 2631 (B*K*L) * 2632 * 2635 (B*K*L) * 2635 (L*LK*LS) * 2635 * 2638 (L*LK*LS) * Axor 2640 * 2641 * 2643 * Axor 2644 * Actos 2646 * 2648 * 2650 * 2651 * 2653 * 2654 (L*LK*LS) * 2657 * 2658 * 2644 * Atego 2628 (B*K) * 2625 * Axor 2826 * Axor 2828 * Axor 2831 2629 LS 2635 (L*LK*LS)		
			SCANIA	112 (F*K*S) R 112 (81...) R 142 MA (4X2)(81...)		
			VOLVO	FH 12 * FH 16 * FH 16 N * NL 10 BR * N * NL 12 BR * N 10BR Mark II * NL 10BR 6x2		
				MERCEDES BENZ		1113 OF * 1115 OF 1215 OF * 1217 OF 1313 OF * 1314 OF * 1315 OF * 1316 OF * 1317 OF * 1318 OF * 1319 OF * 1320 OF 1417 OF * 1419 OF * 1421 OF 1421 OMC 1517 OF * 1518 OF * 1520 OF









Fersa®			Brand / Marca / Marca	Model / Modelo / Modelo	Application / Aplicação / Aplicaciones
62201 2RS / C3	BB		MERCEDES BENZ	1618 OF	Motor / Motor / Engine
				1620 OF * 1621 OF	
				1714 OF * 1721 OF * 1722 OF	
			FIAT	147	
				Elba	
				Fiorino	
				Idea	
				Oggi	
				Panorama	
				Pick-up	
				Prêmio	
				Spazio	
				Tempra	
Uno					
62202 2RS / C3	BB		FIAT	Elba	Motor / Motor / Engine
				Fiorino	
				Pick-up	
				Prêmio	
			Uno		
		LADA	Niva	Embreagem / Embrague / Clutch	
62204 2RS	BB		MERCEDES BENZ	1113 (LPO*OH) * 1114 LPO * 1115 L (OH) * 1118 LPO	Motor / Motor / Engine
				1313 OH * 1314 OH * 1315 OH * 1316 (OH*OHL) *	
				1316 G (OH*OHL) * 1317 OH * 1318 OH * 1319 OH *	
				1320 (OH*OHL)	
				1418 OH * 1419 OH * 1420 (OH*OHL) * 1421 OHL	
				1517 OH * 1518 OH * 1519 OH * 1520 OH * 1521 OH	
				1721 L (OH)	
				352 HL (O) (...74)	
				355 O	
				362 O	
				364 O	
				608 D * E (L*LO) * 708 D * E (L*LO) * 709 L * 710 L * 712 L	
		812 LO * 912 L			
			MERCEDES BENZ	608 (L*LO) * 708 (L*LO) * 809 (LO*OF) * 812 (LO*OF) * 814 LO *	
				817 O * 914 LO * 709 * 710 * 712 * 712 C * 811 * 911 L * 912 *	
				913 * 914 * 914 C * 917	
				1113 (L*LA*LAK*LAS*LK*LP*LS*LP) * 1114 * 1114 (L*LK*LP) *	
				1116 (L*LA*LAK*LAS*LB* LK*LS) * 1118 (L*LK*LP)	
				1113 OF * 1115 OF	
				1214 C * 1214 K * 1214 (L*LK*LS) * 1215 * 1215 C *	
				1215 (L*LA*LK) * 1218 * 1218 R (L)	
	1215 OF * 1217 OF				
	1313 (L*LA*LAK*LB*LK*LS) * 1314 (L*LA*LAK*LB*LK*LS) *				
	1316 (L*LA*LAK*LAS*LB*LK*LS) * 1317 (L*LA*LAK*LK*LS) *				
	1319 (L)				
	1313 OF * 1314 OF * 1315 OF * 1316 OF * 1317 OF * 1318 OF *				
	1319 OF * 1320 OF				
	1414 * 1414 (K*L*LA*LAK*LK) * 1418 * 1418 (E*K*R) *				
	1418 (L*LA*LAK*LK*R(LK)) * 1419 (L*LK*LS) * 1420 (L*LK*LS)				
	1417 OF * 1419 OF * 1421 OF				
	1421 OMC				
	1513 (L*LA*LAK*LB*LG*LK*LS) * 1514 (L*LK*LS) * 1516				
	(L*LA*LAK*LB*LG*LK*LS) * 1517 (L*LK) * 1518 (L*LK*LS) *				
	1519 (L*LAK*LB*LG*LK*LS) * 1520 (L*LK*LP*LPK*LPS*LS) *				
	1521 L * 1524 e 1525 (L*LK*LS)				
	1517 OF * 1518 OF * 1520 OF				
	1614 * 1615 (L*LK*LS) * 1615 * 1618 M * 1618 (L*LK*LS) * 1619 (L)				
	1618 OF				
	1714 OF * 1721 OF * 1722 OF				
	1714 * 1714 (L*K*LK) * 1715 * 1718 * 1718 (A * AK) * K * 1720 L *				
	1721 * 1721 S * 1721 (L*LK) * 1722 S * 1723 * 1723 S * 1725 L				
	2013 (L*LA*LAK*LB*LG*LK*LS) * 2013 6X2 (L) * 2014 (L*LB*LK) *				
	2016 (LB*LK) * 2017 (L*LB*LK)				
2314 (L*LB*LK*LS) * 2318 (L*LB*LK*LS) * 2325 (L*LB*LK*LS)					











Fersa®			Brand / Marca / Marca	Model / Modelo / Modelo	Application / Aplicação / Aplicaciones
62204 2RS	BB		MERCEDES BENZ	2414 (6X4) * 2414 (L) * 2418 (L*LB*LK) * 2420 (L*LB*LK) * 2423 B 6X4 * 2423 K 6X4 * 2425 6X6 (LA) * 2425 (L*LB*LK) * 2428 6X4	Motor / Motor / Engine
			MERCEDES BENZ	1113 OF * 1115 OF	
				1215 OF * 1217 OF	
				1313 OF * 1314 OF * 1315 OF * 1316 OF * 1317 OF * 1318 OF * 1319 OF * 1320 OF	
				1417 OF * 1419 OF * 1421 OF	
				1421 OMC	
				1517 OF * 1518 OF * 1520 OF	
				1618 OF	
1714 OF * 1721 OF * 1722 OF					
62205 2RS	BB		LADA	Laika (1.6)	Cardan / Cardan / Cardan
62206 2RS			ALFA ROMEO	Alfa 164	
62302 2RS / C3	BB		FIAT	Fiorino	Eixo Dianteiro / Eje Delantero / Front Axle
				Pick-up	
				Prêmio	
				Uno	
6300 2RS / C3	BB	References Fersa with Multiple Applications / Referências Fersa com Múltiplas Aplicações / Referencias Fersa con Multiples Aplicaciones			
6301 2RS / C3	BB	References Fersa with Multiple Applications / Referências Fersa com Múltiplas Aplicações / Referencias Fersa con Multiples Aplicaciones			
6302	BB		MERCEDES BENZ	321 H (O) * 321 HL (O) (58...71)	Motor / Motor / Engine
				326 O	
				352 HL (O) (...74)	
				355 O	
				362 O	
				364 O	
		364 HL (O) (...74)			
		VOLVO	B 10M BR		
			B 10R * B 12B * B 12R * B 58 * B 58BR * B 7R * B9		
			B 58		
		FIAT	B 58 BR (...Chassi 304120)		
			180 C * C3 * L * N * N3 (71...)		
FNM 210 C * CM * LN (71...76)					
MERCEDES BENZ	FNM V-15 (69...74)				
	321 (LAP*LAPK*LAPS*LP*LPK*LPS) 51...71				
	321 LAP * LAPK * LAPS * LP * LPK * LPS				
6302 2RS	BB		CHRYSLER	Cherokee * Gran Cherokee	Embreagem / Embrague / Clutch
6302 2RS / C3	BB		LADA	1600	Motor / Motor / Engine
				Laika (1.6)	
				Niva	
6302 Z	BB		AGCO MAXION	Colhetadeira Combinada Automotriz 1170DS * 1175DS * 1630 Arroeira * 3640 Arroeira * 5650 * MF 220A * 220CBD * 220STD * MF 310CBD * 310STD * 210 * 210S * 220 * 310	Motor / Motor / Engine
			FNH	Tratores MF (50X * 55X * 65R * 65X * 85 * 85X * 95 * 95X)	
6302 ZZ / C3	BB	References Fersa with Multiple Applications / Referências Fersa com Múltiplas Aplicações / Referencias Fersa con Multiples Aplicaciones			
6303	BB		MERCEDES BENZ	1313 OH * 1314 OH * 1315 OH * 1316 (OH*OHL) * 1316 G (OH*OHL) * 1317 OH * 1318 OH * 1319 OH * 1320 (OH*OHL)	Motor / Motor / Engine
				364 O	
			MERCEDES BENZ	1018 MBO	
				1111 (L*LA*LAK*LAS*LK*LS)	
				1313 (L*LA*LAK*LB*LK*LS) * 1314 (L*LA*LAK*LB*LK*LS) * 1316 (L*LA*LAK*LB*LK*LS) * 1317 (L*LA*LAK*LB*LK*LS) * 1319 (L)	
			MERCEDES BENZ	1313 OF * 1314 OF * 1315 OF * 1316 OF * 1317 OF * 1318 OF * 1319 OF * 1320 OF	
1018 MBO					
1313 OF * 1314 OF * 1315 OF * 1316 OF * 1317 OF * 1318 OF * 1319 OF * 1320 OF					













Fersa*			Brand / Marca / Marca	Model / Modelo / Modelo	Application / Aplicação / Aplicaciones
6303	BB		AGRALE	Tratores 4100 * 4200 * 4300 * T145 * T146 * T415 * T420	Câmbio / Caja de Cambios / Gearbox
			VALTRA - VALMET	Tratores 360 D * 600 D * 621 ID Tratores 870 CN * CK	Motor / Motor / Engine
			ASIA	Towner	Câmbio / Caja de Cambios / Gearbox
6303 2RS	BB		FNH	Colheitadeiras 4040 * 5030 * 5050 * 8040 * 8055 * TC55 * TC57 * CA1530	Direção / Dirección / Steering
			ASIA	Towner	Câmbio / Caja de Cambios / Gearbox
6303 2RS / C3	BB		AGRALE	CHASSI MA 12.0E-TRONIC * MA 12.0SB E-TRONIC * MA 12.0 LE E-TRONIC	Motor / Motor / Engine
			MERCEDES BENZ	1113 (LPO*OH) * 1114 LPO * 1115 L (OH) * 1118 LPO	
				1313 OH * 1314 OH * 1315 OH * 1316 (OH*OHL) * 1316 G (OH*OHL) * 1317 OH * 1318 OH * 1319 OH * 1320 (OH*OHL)	
				1418 OH * 1419 OH * 1420 (OH*OHL) * 1421 OHL	
				1517 OH * 1518 OH * 1519 OH * 1520 OH * 1521 OH	
				1621 L (OH) * 1623 LG (OH) * 1625 (OH) * 1625 L (OH) * 1628 L (OH) * 1630L (OH) * 1635 (OH) * 1636 L (OH)	
				370 RS*RSD*RST* ST*U*UP (O) * 371 RS*RSD*RST* ST*U*UP (O)	
				400 (R * RS * RSD * RSL) (O)	
				500 (O*M* R)	
				608 D * E (L*LO) * 708 D * E (L*LO) * 709 L * 710 L * 712 L	
				812 LO * 912 L	
			SCANIA	140 (LK*LKS)	
			VOLKSWAGEN	22-140 * 22-210 * 23-210 * 23-220 * 23-250 E * 23-310 TITAN	
		VOLVO	B 10M BR		
			B 10R * B 12B * B 12R * B 58 * B 58BR * B 7R *B9		
			B 58		
			B 58 BR (...Chassi 304120)		
		MERCEDES BENZ	608 (L*LO) * 708 (L*LO) * 809 (LO*OF) * 812 (LO*OF) * 814 LO * 817 O * 914 LO * 709 * 710 * 712 * 712 C * 811 * 911 L * 912 * 913 * 914 * 914 C * 917		
			1018 MBO		
			1111 (L*LA*LAK* LAS*LK*LS)		
			1113 (L*LA*LAK*LAS*LK*LP*LS*LP) * 1114 * 1114 (L*LK*LP) * 1116 (L*LA*LAK*LAS*LB*LK*LS) * 1118 (L*LK*LP)		
			1113 OF * 1115 OF		
			1313 (L*LA*LAK*LB*LK*LS) * 1314 (L*LA*LAK*LB*LK*LS) * 1316 (L*LA*LAK*LAS*LB*LK*LS) * 1317 (L*LA*LAK*LK*LS) * 1319 (L)		
			1313 OF * 1314 OF * 1315 OF * 1316 OF * 1317 OF * 1318 OF * 1319 OF * 1320 OF		
			1414 * 1414 (K*L*LA*LAK*LK) * 1418 * 1418 (E*K*R) * 1418 (L*LA*LAK*LK*R(LK)) * 1419 (L*LK*LS) * 1420 (L*LK*LS)		
			1417 OF * 1419 OF * 1421 OF		
			1421 OMC		
1513 (L*LA*LAK*LB*LG*LK*LS) * 1514 (L*LK*LS) * 1516 (L*LA*LAK*LB*LG*LK*LS) * 1517 (L*LK) * 1518 (L*LK*LS) * 1519 (L*LAK*LB*LG*LK*LS) * 1520 (L*LK*LP*LPK*LPS*LS) * 1521 L * 1524 e 1525 (L*LK*LS)					
1517 OF * 1518 OF * 1520 OF					
1614 * 1615 (L*LK*LS) * 1615 * 1618 M * 1618 (L*LK*LS) * 1619 (L)					
1618 OF					
1620(L*LK*LS) * 1620 6X2 51 (L) * 1621 (L*LK*LS) * 1622(L*LK*LS) * 1623 (L*LS) * 1625(L*LK*LS) * 1630 (L*LK*LS) * 1632 (L*LS) * 1633(L*LK*LS) * 1634 (L*LS) * 1635 L					
1620 OF * 1621 OF					
2013 (L*LA*LAK*LB*LG*LK*LS) * 2013 6X2 (L) * 2014 (L*LB*LK) * 2016 (LB*LK) * 2017 (L*LB*LK)					
2213 (L*LB*LK*LS) * 2213 6X6 (LA) * 2214 * 2215 (L*LB*LK*LS) * 2216 (L*LA*LAK*LB*LG*LK*LS) * 2217 (L*LB*LK*LS) * 2219 (L*LA*LAK*LB*LG*LK*LS) * 2220 * 2222 * 2225 (L*LB*LK*LS)					
Axor 2625 * 2628 * 2629 (LK*LS) * 2631 (B*K*L) * 2632 * 2635 (B*K*L) * 2635 (L*LK*LS) * 2635 * 2638 (L*LK*LS) * Axor 2640 * 2641 * 2643 * Axor 2644 * Actos 2646 * 2648 * 2650 * 2651 * 2653 * 2654 (L*LK*LS) * 2657 * 2658 * 2644 * Atego 2628 (B*K) * 2625 * Axor 2826 * Axor 2828 * Axor 2831					

















Fersa®			Brand / Marca / Marca	Model / Modelo / Modelo	Application / Aplicação / Aplicaciones
6303 2RS / C3	BB		MERCEDES BENZ	2629 LS	Motor / Motor / Engine
			SCANIA	112 (F*K*S)	
				R 112 (81...)	
				R 142 MA (4X2)(81...)	
				T 142 E (6X4)	
			VOLKSWAGEN	11-130 * 11-140 * 11-160	
				12-140 * 12-140 H * 12-140 T * 12-170 BT	
				13-130 * 13-150 * 13-170 * 13-180E * 13-190 (77...)E * 13-210	
				14-140 * 14-150 * 14-170 BT * 14-180 * 14-200 * 14-210 * 14-220	
				15-170 * 15-170E * 15-180 * 15-180E * 15-180 OD * 15-190 (77...) * 15-190 (77...)EOD	
				16-170 * 16-180 * 16-200 * 16-210 * 16-220 CO * 16300	
		VOLVO	N * NL 10 BR * N * NL 12 BR * N 10BR Mark II * NL 10BR 6x2		
			MERCEDES BENZ	1018 MBO	
			1113 OF * 1115 OF		
			1313 OF * 1314 OF * 1315 OF * 1316 OF * 1317 OF * 1318 OF * 1319 OF * 1320 OF		
			1417 OF * 1419 OF * 1421 OF		
			1421 OMC		
			1517 OF * 1518 OF * 1520 OF		
			1618 OF		
			1620 OF * 1621 OF		
			ASIA	Topic	
			FIAT	Tempira	
			FORD	Courier	
				Escort	
				Fiesta	
			GENERAL MOTORS	Blazer * Gran Blazer	
				Omega * Omega Suprema (2.0 * 2.2 * 3.0 * 4.1)	
			GENERAL MOTORS	S 10 (2.2 * 2.4 * 2.5 * 2.8 TD * 4.3)	
			GENERAL MOTORS	Vectra	
			MBB	180 D	
			MERCEDES BENZ	MB 180	
			VOLKSWAGEN	Logus	
				Logus (1.6 * 1.8)	
		Pointer (1.8 * 2.0)			
		Santana * Santana Quantum (1.6 * 1.8 * 2.0)			
			CBT	2070 * 2080 * 2100 * 2105 (4x2) * 2400 * 2400 (4x4) * 2500 * 2600	
				Tratores 1000 * 1000 (4x4) * 1020 * 1020 (4x4) * 1065 * 1065 (4x4) * 1090 * 1105	
			VALTRA - VALMET	Tratores 60 * 60 ID * 62 * 65 * 65 Cafeeiro * 68 * 68 Cafeeiro * 78 * 80 * M80 * 85 * 85ID * 86 * 86 ID * 88 * 88 ID	
Tratores 110 ID * 110ID II * 118 * 118 (4x4) * 128 * 128 (4x4)					
Tratores 1280 * 1284 * 1580 * 1780 * 1780 (4x4) * 1380 * 1680 * 1880 * 118 * 128 * 138 * 148 * 148 (4x4)					
Tratores 685 * 685C (4x4) * 785 * 785C (4x4) * 880 Cafeeiro * 880 (4x4) * 885 * 980 (4x4) * 985 * 985F * 1180 * 1184					
6303 C3	BB		VOLVO	B 58 B 58 BR (...Chassi 304120)	Motor / Motor / Engine
6303 RS / C3	BB		MERCEDES BENZ	1517 OH * 1518 OH * 1519 OH * 1520 OH * 1521 OH	Motor / Motor / Engine
			MERCEDES BENZ	1513 (L*LA*LAK*LB*LG*LK*LS) * 1514 (L*LK*LS) * 1516 (L*LA*LAK*LB*LG*LK*LS) * 1517 (L*LK) * 1518 (L*LK*LS) * 1519 (L*LAK*LB*LG*LK*LS) * 1520 (L*LK*LP*LPK*LPS*LS) * 1521 L * 1524 e 1525 (L*LK*LS)	
		1517 OF * 1518 OF * 1520 OF			
		1614 * 1615 (L*LK*LS) * 1615 * 1618 M * 1618 (L*LK*LS) * 1619 (L)			
			1618 OF		















Fersa*			Brand / Marca / Marca	Model / Modelo / Modelo	Application / Aplicação / Aplicaciones							
6303 RS / C3	BB		MERCEDES BENZ	2635 (L*LK*LS)	Motor / Motor / Engine							
			AGCO MAXION	Tratores MF 235 (4x4) Antigo * MF 235 Moderno* 250 * 265 * MF265 RD * 270 * 274 * 275 * 285 * 290 * MF 292 (4x4) * 295 * 296 * 299								
6303 RSR / C3	BB		MERCEDES BENZ	1517 OF * 1518 OF * 1520 OF 1618 OF	Motor / Motor / Engine							
6303 Z	BB		AGCO MAXION	Colheteadeira Combinada Automotriz 1170DS * 1175DS * 1630 Arroeira * 3640 Arroeira * 5650 * MF 220A * 220CBD * 220STD * MF 310CBD * 310STD * 210 * 210S * 220 * 310 Tratores MF (50X * 55X * 65R * 65X * 85 * 85X * 95 * 95X)	Motor / Motor / Engine							
			AGRALE	Tratores 4100 * 4200 * 4300 * T145 * T146 * T415 * T420								
6303 Z / C3	BB		MERCEDES BENZ	608 (L*LO) * 708 (L*LO) * 809 (LO*OF) * 812 (LO*OF) * 814 LO * 817 O * 914 LO * 709 * 710 * 712 * 712 C * 811 * 911 L * 912 * 913 * 914 * 914 C * 917	Motor / Motor / Engine							
6303 ZZ	BB		VALTRA - VALMET	Tratores 110 ID * 110ID II * 118 * 118 (4x4) * 128 * 128 (4x4)	Motor / Motor / Engine							
				Tratores 60 * 60 ID * 62 * 65 * 65 Cafeeiro * 68 * 68 Cafeeiro * 78 * 80 * M80 * 85 * 85ID * 86 * 86 ID * 88 * 88 ID								
				Tratores 360 D * 600 D * 621 ID								
6303 ZZ / C3	BB		MERCEDES BENZ	1721 L (OH) 608 D * E (L*LO) * 708 D * E (L*LO) * 709 L * 710 L * 712 L	Motor / Motor / Engine							
			MERCEDES BENZ	1714 OF * 1721 OF * 1722 OF 1714 * 1714 (L*K*LK) * 1715 * 1718 * 1718 (A * AK) * K * 1720 L * 1721 * 1721 S * 1721 (L*LK) * 1722 S * 1723 * 1723 S * 1725 L 2013 (L*LA*LAK*LB*LG*LK*LS) * 2013 6X2 (L) * 2014 (L*LB*LK) * 2016 (LB*LK) * 2017 (L*LB*LK) 2213 (L*LB*LK*LS) * 2213 6X6 (LA) * 2214 * 2215 (L*LB*LK*LS) * 2216 (L*LA*LAK*LB*LG*LK*LS) * 2217 (L*LB*LK*LS) * 2219 (L*LA*LAK*LB*LG*LK*LS) * 2220 * 2222 * 2225 (L*LB*LK*LS) 2314 (L*LB*LK*LS) * 2318 (L*LB*LK*LS) * 2325 (L*LB*LK*LS) 2414 (6X4) * 2414 (L) * 2418 (L*LB*LK) * 2420 (L*LB*LK) * 2423 B 6X4 * 2423 K 6X4 * 2425 6X6 (LA) * 2425 (L*LB*LK) * 2428 6X4								
		MERCEDES BENZ		1714 OF * 1721 OF * 1722 OF								
		6304		BB			MERCEDES BENZ	321 H (O) * 321 HL (O) (58...71) 326 O 364 HL (O) (...74)	Motor / Motor / Engine			
							SCANIA	101 (L*LS) * 111 (B) * 111 Articulado (B) 110 (B) 110 (L*LS) 115 * 116 BR 140 (LK*LKS) P 93 * R 113 * R 143* T 113				
								VOLVO		B 10M BR B 58 B 58 BR (...Chassi 304120)	Direção / Dirección / Steering	
										FIAT	180 C * C3 * L * N * N3 (71...) FNM 210 C * CM * LN (71...76) FNM D-11000 (58...72) FNM V-15 (69...74)	Motor / Motor / Engine
											MERCEDES BENZ	1018 MBO 1111 (L*LA*LAK* LAS*LK*LS)
								SCANIA				112 (F*K*S) 75 * 76 B*L*LS F 113 * L 113 * K 113 R 112 (81...) R 142 MA (4X2)(81...) T 142 E (6X4)
			VOLVO								N * NL 10 BR * N * NL 12 BR * N 10BR Mark II * NL 10BR 6x2	Direção / Dirección / Steering
MERCEDES BENZ	1018 MBO		Motor / Motor / Engine									













Fersa®			Brand / Marca / Marca	Model / Modelo / Modelo	Application / Aplicação / Aplicações	
6304	BB		AGRALE	Tratores 4100 * 4200 * 4300 * T145 * T146 * T415 * T420	Eixo Cardan / Eje Cardan / Cardan Shaft Motor / Motor / Engine	
			VALTRA - VALMET	Todos / Todos / All	Direção / Dirección / Steering	
				Tratores 110 ID * 110ID II * 118 * 118 (4x4) * 128 * 128 (4x4)	Motor / Motor / Engine	
				Tratores 360 D * 600 D * 621 ID		
Tratores 685 * 685C (4x4) * 785 * 785C (4x4) * 880 Cafeeiro * 880 (4x4) * 885 * 980 (4x4) * 985 * 985F * 1180 * 1184	Tomada de Potência / Toma de Potencia / Power Take-off					
6304 2RS	BB		FIAT	190 (77...)	Motor / Motor / Engine Direção / Dirección / Steering	
			VOLVO	FH 12 * FH 16	Motor / Motor / Engine Direção / Dirección / Steering	
			AGCO MAXION	Colheteira Combinada Automotriz 1170DS * 1175DS * 1630 Arroeira * 3640 Arroeira * 5650 * MF 220A * 220CBD * 220STD * MF 310CBD * 310STD * 210 * 210S * 220 * 310	Embreagem / Embrague / Clutch	
				Tratores 60 * 60 ID * 62 * 65 * 65 Cafeeiro * 68 * 68 Cafeeiro * 78 * 80 * M80 * 85 * 85ID * 86 * 86 ID * 88 * 88 ID		
	Tratores 870 CN * CK					
	VALTRA - VALMET	Tratores 685 * 685C (4x4) * 785 * 785C (4x4) * 880 Cafeeiro * 880 (4x4) * 885 * 980 (4x4) * 985 * 985F * 1180 * 1184	Mancal / Cojinete / Bearing			
		Tratores 1280 * 1284 * 1580 * 1780 * 1780 (4x4) * 1380 * 1680 * 1880 * 118 * 128 * 138 * 148 * 148 (4x4)				
		Tratores 110 ID * 110ID II * 118 * 118 (4x4) * 128 * 128 (4x4)				
	ASIA	Topic	Câmbio / Caja de Cambios / Gearbox			
	6304 2RS / C3	BB		MERCEDES BENZ	1418 OH * 1419 OH * 1420 (OH*OHL) * 1421 OHL	Motor / Motor / Engine
MERCEDES BENZ				1414 * 1414 (K*L*LA*LAK*LK) * 1418 * 1418 (E*K*R) * 1418 (L*LA*LAK*LK*R(LK)) * 1419 (L*LK*LS) * 1420 (L*LK*LS)		
MERCEDES BENZ				1417 OF * 1419 OF * 1421 OF 1421 OMC		
MERCEDES BENZ			1417 OF * 1419 OF * 1421 OF 1421 OMC	Câmbio / Caja de Cambios / Gearbox		
VOLKSWAGEN			Gol * Parati * Voyage * Saveiro Passat			
6304 C3	BB		MERCEDES BENZ	1113 OF * 1115 OF 1313 OF * 1314 OF * 1315 OF * 1316 OF * 1317 OF * 1318 OF * 1319 OF * 1320 OF	Motor / Motor / Engine	
			SCANIA	101 (L*LS) * 111 (B) * 111 Articulado (B)		
				111 (L*LS*LT)		
				K 113		
				K 94 IB (4X2)		
			MERCEDES BENZ	1113 (LPO*OH) * 1114 LPO * 1115 L (OH) * 1118 LPO		Motor / Motor / Engine
				1313 OH * 1314 OH * 1315 OH * 1316 (OH*OHL) * 1316 G (OH*OHL) * 1317 OH * 1318 OH * 1319 OH * 1320 (OH*OHL)		
				352 HL (O) (...74)		
				355 O		
				362 O		
		364 O				
			SCANIA	P 114 GA (4X2) * R 114 GA (4X2 * 6X4) * T 114 GA (4X2) * T 114 LA (6X2)		
				P 94 CB (4x2 * 6x2 * 6X4)		
				P 94 GA*GB (4X2)		
MERCEDES BENZ	1113 (L*LA*LAK*LAS*LK*LP*LS*LP) * 1114 * 1114 (L*LK*LP) * 1116 (L*LA*LAK*LAS*LB* LK*LS) * 1118 (L*LK*LP)					
VALTRA - VALMET		Tratores 60 * 60 ID * 62 * 65 * 65 Cafeeiro * 68 * 68 Cafeeiro * 78 * 80 * M80 * 85 * 85ID * 86 * 86 ID * 88 * 88 ID				



















Fersa®			Brand / Marca / Marca	Model / Modelo / Modelo	Application / Aplicação / Aplicaciones
6304 ZZ	BB		AGCO MAXION	Tratores MF (50X * 55X * 65R * 65X * 85 * 85X * 95 * 95X)	Motor / Motor / Engine
			VALTRA - VALMET	Tratores 60 * 60 ID * 62 * 65 * 65 Cafeeiro * 68 * 68 Cafeeiro * 78 * 80 * M80 * 85 * 85ID * 86 * 86 ID * 88 * 88 ID	Embreagem / Embrague / Clutch
				KIA	Besta (2.2 * 2.7 * GS)
6304 ZZ / C3	BB	References Fersa with Multiple Applications / Referências Fersa com Múltiplas Aplicações / Referencias Fersa con Multiples Aplicaciones			
6305	BB		MERCEDES BENZ	1517 OH * 1518 OH * 1519 OH * 1520 OH * 1521 OH	Motor / Motor / Engine
				321 H (O) * 321 HL (O) (58...71)	Motor / Motor / Engine
				326 O	
		SCANIA	115 * 116 BR	Motor / Motor / Engine	
			K 113		
			K 94 IB (4X2)		
			MERCEDES BENZ	1513 (L*LA*LAK*LB*LG*LK*LS) * 1514 (L*LK*LS) * 1516 (L*LA*LAK*LB*LG*LK*LS) * 1517 (L*LK) * 1518 (L*LK*LS) * 1519 (L*LAK*LB*LG*LK*LS) * 1520 (L*LK*LP*LPK*LPS*LS) * 1521 L * 1524 e 1525 (L*LK*LS)	Motor / Motor / Engine
				1517 OF * 1518 OF * 1520 OF	Motor / Motor / Engine
				312 (L*LK*LP) 51...58	
				331 (L*LPK*LPS) 60...68	
				P 114 GA (4X2) * R 114 GA (4X2 * 6X4) * T 114 GA (4X2) * T 114 LA (6X2)	
				P 94 CB (4x2 * 6x2 * 6X4)	
SCANIA	P 94 GA*GB (4X2)	Motor / Motor / Engine			
	MERCEDES BENZ	1517 OF * 1518 OF * 1520 OF	Motor / Motor / Engine		
	AGRALE	Tratores 4100 * 4200 * 4300 * T145 * T146 * T415 * T420	Câmbio / Caja de Cambios / Gearbox		
	FNH	Tratores 4600 * 4610 * 4630 * 5600 * 5610 * 5630 * 6600 * 6610 * 6630 * 7610 * 7630 * 7810 * 7830 * 8030 * 8BR	Redução / Reducción / Reduction		
	LADA	Niva	Câmbio / Caja de Cambios / Gearbox		
6305 2RS	BB		SCANIA	101 (L*LS) * 111 (B) * 111 Articulado (B)	Caja de Transferência / Caja de Transferencia / Transfer Case
				110 (B)	Embreagem / Embrague / Clutch
				110 (L*LS)	Motor / Motor / Engine
				115 * 116 BR	Embreagem / Embrague / Clutch
				115 * 116 BR	Motor / Motor / Engine
				140 (LK*LKS)	Embreagem / Embrague / Clutch
				K 113	Motor / Motor / Engine
				K 94 IB (4X2)	Embreagem / Embrague / Clutch
				P 93 * R 113 * R 143* T 113	Embreagem / Embrague / Clutch
				FORD	F 100 (61...80 Diesel) * F 600 (56...77 Gas.) * F 700 (77...80) * F 750 (72...77) * 750 * 2000 * 4000
		F 7000 * FT 7000 e FT 8000 (77...80); F 8000 e F 8500 (77...79) * FT 8500	Embreagem / Embrague / Clutch		
		112 (F*K*S)			
		75 * 76 B*L*LS			
		F 113 * L 113 * K 113			
		P 114 GA (4X2) * R 114 GA (4X2 * 6X4) * T 114 GA (4X2) * T 114 LA (6X2)			
		SCANIA	P 94 CB (4x2 * 6x2 * 6X4)	Motor / Motor / Engine	
			P 94 GA*GB (4X2)	Embreagem / Embrague / Clutch	
			R 112 (81...)	Embreagem / Embrague / Clutch	
				Motor / Motor / Engine	
				Motor / Motor / Engine	













Fersa®			Brand / Marca / Marca	Model / Modelo / Modelo	Application / Aplicação / Aplicaciones
6305 2RS	BB		SCANIA	R 142 MA (4X2)(81...) T 142 E (6X4)	Embreagem / Embrague / Clutch
			AGCO MAXION	Colhedeira Combinada Automotriz 1170DS * 1175DS * 1630 Arroeira * 3640 Arroeira * 5650 * MF 220A * 220CBD * 220STD * MF 310CBD * 310STD * 210 * 210S * 220 * 310	Cilindro da Trilha / Cilindro de Camino / Trail Cylinder
			FNH	Colhedeiras 4040 * 5030 * 5050 * 8040 * 8055 * TC55 * TC57 * CA1530	Motor / Motor / Engine Picador de Palha / Picador de Paja / Straw Chopper Saca-Palhas / Empacadora / Packing
6305 2RS / C3	BB		SCANIA	111 (L*LS*LT)	Motor / Motor / Engine
				115 * 116 BR	
				K 113	
				P 93 * R 113 * R 143 * T 113	
			SCANIA	112 (F*K*S)	
				F 113 * L 113 * K 113 P 114 GA (4X2) * R 114 GA (4X2 * 6X4) * T 114 GA (4X2) * T 114 LA (6X2) R 112 (81...)	
References Fersa with Multiple Applications / Referências Fersa com Múltiplas Aplicações / Referencias Fersa con Multiples Aplicaciones					
6305 C3	BB		GENERAL MOTORS	Caravan * Opala Corsa (hatch * pick-up * sedan)	Câmbio / Caja de Cambios / Gearbox
			VOLKSWAGEN	Kombi Kombi (1500 * 1600)	Eixo Traseiro / Eje Trasero / Rear Axle Caixa de redução de veloc / Caja Reductora / Transfer case
			SCANIA	140 (LK*LKS)	Motor / Motor / Engine
			SCANIA	R 142 MA (4X2)(81...) T 142 E (6X4)	
			AGRALE	Tratores 4100 * 4200 * 4300 * T145 * T146 * T415 * T420	Câmbio / Caja de Cambios / Gearbox Motor / Motor / Engine
		References Fersa with Multiple Applications / Referências Fersa com Múltiplas Aplicações / Referencias Fersa con Multiples Aplicaciones			
6306	BB		AGRALE	Tratores 4100 * 4200 * 4300 * T145 * T146 * T415 * T420	Redução / Reducción / Reduction
			FNH	923-4	Boca de Milho / Boca de Maiz
				Tratores 4600 * 4610 * 4630 * 5600 * 5610 * 5630 * 6600 * 6610 * 6630 * 7610 * 7630 * 7810 * 7830 * 8030 * 8BR	Câmbio / Caja de Cambios / Gearbox Tomada de Força / Toma de Fuerza / Power Take-off
			VALTRA - VALMET	Tratores 60 * 60 ID * 62 * 65 * 65 Cafeeiro * 68 * 68 Cafeeiro * 78 * 80 * M80 * 85 * 85ID * 86 * 86 ID * 88 * 88 ID	Câmbio / Caja de Cambios / Gearbox
				Tratores 110 ID * 110ID II * 118 * 118 (4x4) * 128 * 128 (4x4) Tratores 360 D * 600 D * 621 ID	
			References Fersa with Multiple Applications / Referências Fersa com Múltiplas Aplicações / Referencias Fersa con Multiples Aplicaciones		
6306 2RS	BB		FIAT	180 C * C3 * L * N * N3 (71...)	Embreagem / Embrague / Clutch Motor / Motor / Engine
				FNM 210 C * CM * LN (71...76)	Embreagem / Embrague / Clutch Motor / Motor / Engine
				FNM D-11000 (58...72)	Embreagem / Embrague / Clutch Motor / Motor / Engine
				FNM D-9500 (50...57)	Embreagem / Embrague / Clutch
			AGCO MAXION	Colhedeira Combinada Automotriz 1170DS * 1175DS * 1630 Arroeira * 3640 Arroeira * 5650 * MF 220A * 220CBD * 220STD * MF 310CBD * 310STD * 210 * 210S * 220 * 310	Plataforma Dianteira / Plataforma Delantera / Front Platform Tanque de Grãos / Tanque de Granos / Grain Tank Tomada de Potência / Toma de Potencia / Power Take-off
				Tratores MF 235 (4x4) Antigo * MF 235 Moderno* 250 * 265 * MF265 RD * 270 * 274 * 275 * 285 * 290 * MF 292 (4x4) * 295 * 296 * 299	Embreagem / Embrague / Clutch













Fersa®			Brand / Marca / Marca	Model / Modelo / Modelo	Application / Aplicação / Aplicaciones		
6306 2RS / C3	BB		FIAT	Tempra	Câmbio / Caja de Cambios / Gearbox		
					Eixo Dianteiro / Eje Delantero / Front Axle		
References Fersa with Multiple Applications / Referências Fersa com Múltiplas Aplicações / Referencias Fersa con Multiples Aplicaciones							
6306 C3	BB		VOLKSWAGEN	1600 * 1600TL	Eixo Traseiro / Eje Trasero / Rear Axle		
				Brasilia			
				Fusca			
				Karmann Ghia			
				Kombi			
				Kombi			
				Kombi (1500 * 1600)	Caixa de redução de veloc / Caja Reductora / Transfer case		
TC	Eixo Traseiro / Eje Trasero / Rear Axle						
Variant							
6306 D25 2RS / C3	BB	References Fersa with Multiple Applications / Referências Fersa com Múltiplas Aplicações / Referencias Fersa con Multiples Aplicaciones					
6306 NR	BB		CBT	Todos / Todos / All	Tomada de Potência / Toma de Potencia / Power Take-off		
					GENERAL MOTORS	Caravan * Opala	Câmbio / Caja de Cambios / Gearbox
		LADA	Silverado				
					Laika (1.6)	Eixo / Eje / Shaft	
			Niva				
6306 NR 2RS / C3	BB		GENERAL MOTORS	Caravan * Opala	Câmbio / Caja de Cambios / Gearbox		
6306 ZNR	BB		KIA	Besta (2.2 * 2.7 * GS)	Câmbio / Caja de Cambios / Gearbox		
6306 ZNR / C3	BB		GENERAL MOTORS	Caravan * Opala	Câmbio / Caja de Cambios / Gearbox		
6306 ZZ	BB		VOLVO	B 58	Motor / Motor / Engine		
				B 58 BR (...Chassi 304120)			
			TOYOTA	Bandeirante	Caixa de transferência / Caja de Transferencia / Transfer Case		
6306 ZZ / C3	BB		VOLKSWAGEN	Sedan	Eixo Traseiro / Eje Trasero / Rear Axle		
				References Fersa with Multiple Applications / Referências Fersa com Múltiplas Aplicações / Referencias Fersa con Multiples Aplicaciones			
6307	BB		SCANIA	140 (LK*LKS)	Motor / Motor / Engine		
						SCANIA	R 142 MA (4X2)(81...) T 142 E (6X4)
			AGCO MAXION		Tratores MF 235 (4x4) Antigo * MF 235 Moderno* 250 * 265 * MF265 RD * 270 * 274 * 275 * 285 * 290 * MF 292 (4x4) * 295 * 296 * 299	Tração Dianteira / Tracción Delantera / Front Traction	
				Tratores MF (50X * 55X * 65R * 65X * 85 * 85X * 95 * 95X)			
				CBT	Tratores 8060 (4x2) * 8060 (4x4) * 8240 * 8240A * 8260 * 8440 * 8450	Eixo Dianteiro / Eje Delantero / Front Axle Tomada de Potência / Toma de Potencia / Power Take-off	
			VALTRA - VALMET	FNH	Colheitadeiras 4040 * 5030 * 5050 * 8040 * 8055 * TC55 * TC57 * CA1530	Câmbio / Caja de Cambios / Gearbox	
					Tratores 60 * 60 ID * 62 * 65 * 65 Cafeeiro * 68 * 68 Cafeeiro * 78 * 80 * M80 * 85 * 85ID * 86 * 86 ID * 88 * 88 ID		
					Tratores 110 ID * 110ID II * 118 * 118 (4x4) * 128 * 128 (4x4)		Tomada de Potência / Toma de Potencia / Power Take-off
					Tratores 360 D * 600 D * 621 ID		Câmbio / Caja de Cambios / Gearbox
		6307 2RS	BB		AGCO MAXION	Tratores MF 235 (4x4) Antigo * MF 235 Moderno* 250 * 265 * MF265 RD * 270 * 274 * 275 * 285 * 290 * MF 292 (4x4) * 295 * 296 * 299	Embreagem / Embrague / Clutch
Diversos							
6307 2RS / C3	BB	References Fersa with Multiple Applications / Referências Fersa com Múltiplas Aplicações / Referencias Fersa con Multiples Aplicaciones					











Fersa®			Brand / Marca / Marca	Model / Modelo / Modelo	Application / Aplicação / Aplicaciones
6307 C3	BB		VALTRA - VALMET	Tratores 60 * 60 ID * 62 * 65 * 65 Cafeeiro * 68 * 68 Cafeeiro * 78 * 80 * M80 * 85 * 85ID * 86 * 86 ID * 88 * 88 ID Tratores 110 ID * 110ID II * 118 * 118 (4x4) * 128 * 128 (4x4)	Câmbio / Caja de Cambios / Gearbox
6307 NR	BB		AGCO MAXION	Colheteira Combinada Automotriz 1170DS * 1175DS * 1630 Arroeira * 3640 Arroeira * 5650 * MF 220A * 220CBD * 220STD * MF 310CBD * 310STD * 210 * 210S * 220 * 310	Câmbio / Caja de Cambios / Gearbox
			FNH	Colheteiras 4040 * 5030 * 5050 * 8040 * 8055 * TC55 * TC57 * CA1530	
			FORD	F 400	Direção / Dirección / Steering
6307 2RS NR	BB		ASIA	Topic	Câmbio / Caja de Cambios / Gearbox
6307 RS	BB		AGCO MAXION	Colheteira Combinada Automotriz 1170DS * 1175DS * 1630 Arroeira * 3640 Arroeira * 5650 * MF 220A * 220CBD * 220STD * MF 310CBD * 310STD * 210 * 210S * 220 * 310 Tratores MF 235 (4x4) Antigo * MF 235 Moderno* 250 * 265 * MF265 RD * 270 * 274 * 275 * 285 * 290 * MF 292 (4x4) * 295 * 296 * 299	Conjunto Saca-palha / Conjunto Saca-Paja / Straw Extractor
6307 Z	BB		TOYOTA	Bandeirante	Caixa de transferência / Caja de Transferencia / Transfer Case Câmbio / Caja de Cambios / Gearbox
6307 ZNR	BB		DODGE	400 * 450 * 700 * 750 * 900 * 950	Caixa de Mudanças / Caja de Cambios / Gearbox
			FORD	F 100 (61...80 Diesel) * F 600 (56...77 Gas.) * F 700 (77...80) * F 750 (72...77) * 750 * 2000 * 4000	
			GENERAL MOTORS	A-C-D 60* 70* 80* 90* 99 Turbo e 3500 Heavy Duty	
6308	BB		FIAT	180 C * C3 * L * N * N3 (71...) FNM D-11000 (58...72)	Caixa de Mudanças / Caja de Cambios / Gearbox
			FNH	Colheteiras 4040 * 5030 * 5050 * 8040 * 8055 * TC55 * TC57 * CA1530 Tratores 4600 * 4610 * 4630 * 5600 * 5610 * 5630 * 6600 * 6610 * 6630 * 7610 * 7630 * 7810 * 7830 * 8030 * 8BR	Câmbio / Caja de Cambios / Gearbox
			VALTRA - VALMET	Tratores 110 ID * 110ID II * 118 * 118 (4x4) * 128 * 128 (4x4) Tratores 1280 * 1284 * 1580 * 1780 * 1780 (4x4) * 1380 * 1680 * 1880 * 118 * 128 * 138 * 148 * 148 (4x4) Tratores 870 CN * CK	Tomada de Potência / Toma de Potencia / Power Take-off
6308 2RS	BB		FIAT	Tipo	Motor / Motor / Engine
			AGCO MAXION	Colheteira Combinada Automotriz 1170DS * 1175DS * 1630 Arroeira * 3640 Arroeira * 5650 * MF 220A * 220CBD * 220STD * MF 310CBD * 310STD * 210 * 210S * 220 * 310	Batedor Traseiro / Bastidor Traseiro / Rear Chassis Câmbio / Caja de Cambios / Gearbox
			FNH	Colheteiras 4040 * 5030 * 5050 * 8040 * 8055 * TC55 * TC57 * CA1530	Cilindro Côncavo de Barras / Cilindro Côncavo de Barras / Bars Concave Cylinder
6308 N	BB		DODGE	400 * 450 * 700 * 750 * 900 * 950	Caixa de Mudanças / Caja de Cambios / Gearbox
			FORD	Cargo 814 Cargo 815 * 815 E F 100 (61...80 Diesel) * F 600 (56...77 Gas.) * F 700 (77...80) * F 750 (72...77) * 750 * 2000 * 4000	
			GENERAL MOTORS	A-C-D 60* 70* 80* 90* 99 Turbo e 3500 Heavy Duty	
6308 NR	BB		FORD	Cargo 814 Cargo 815 * 815 E F 100 (61...80 Diesel) * F 600 (56...77 Gas.) * F 700 (77...80) * F 750 (72...77) * 750 * 2000 * 4000	Caixa de Mudanças / Caja de Cambios / Gearbox
			GENERAL MOTORS	A-C-D 60* 70* 80* 90* 99 Turbo e 3500 Heavy Duty	
			FORD	F 1000 (79...)	
				F 2000 (80...)	
				F 350	
				F 400 F 4000 (75...)	
			GENERAL MOTORS	D 20 (Bonanza * Veraneio) D 40	
6308 NR / C3	BB		TOYOTA	Bandeirante	Caixa de Mudanças / Caja de Cambios / Gearbox
6308 ZNR	BB		DODGE	400 * 450 * 700 * 750 * 900 * 950	Caixa de Mudanças / Caja de Cambios / Gearbox
			GENERAL MOTORS	A-C-D 60* 70* 80* 90* 99 Turbo e 3500 Heavy Duty	

















Fersa®			Brand / Marca / Marca	Model / Modelo / Modelo	Application / Aplicação / Aplicaciones
6308 ZNR / C3	BB		MERCEDES BENZ	1113 (LPO*OH) * 1114 LPO * 1115 L (OH) * 1118 LPO	Caixa de Mudanças / Caja de Cambios / Gearbox
				1313 OH * 1314 OH * 1315 OH * 1316 (OH*OHL) * 1316 G (OH*OHL) * 1317 OH * 1318 OH * 1319 OH * 1320 (OH*OHL)	
			MERCEDES BENZ	1113 (L*LA*LAK*LAS*LK*LP*LS*LP) * 1114 * 1114 (L*LK*LP) * 1116 (L*LA*LAK*LAS*LB* LK*LS) * 1118 (L*LK*LP)	
				1113 OF * 1115 OF	
				1313 (L*LA*LAK*LB*LK*LS) * 1314 (L*LA*LAK*LB*LK*LS) * 1316 (L*LA*LAK*LAS*LB*LK*LS) * 1317 (L*LA*LAK*LK*LS)* 1319 (L)	
				1313 OF * 1314 OF * 1315 OF * 1316 OF * 1317 OF * 1318 OF * 1319 OF * 1320 OF	
				2213 (L*LB*LK*LS) * 2213 6X6 (LA) * 2214 * 2215 (L*LB*LK*LS) * 2216 (L*LA*LAK*LB*LG*LK*LS) * 2217 (L*LB*LK*LS) * 2219 (L*LA*LAK*LB*LG*LK*LS) * 2220 * 2222 * 2225 (L*LB*LK*LS)	
				321 LAP * LAPK * LAPS * LP * LPK * LPS	
				1113 OF * 1115 OF	
			MERCEDES BENZ	1313 OF * 1314 OF * 1315 OF * 1316 OF * 1317 OF * 1318 OF * 1319 OF * 1320 OF	
1313 OF * 1314 OF * 1315 OF * 1316 OF * 1317 OF * 1318 OF * 1319 OF * 1320 OF					
6309	BB		AGCO MAXION	Colhedeira Combinada Automotriz 1170DS * 1175DS * 1630 Arroeira * 3640 Arroeira * 5650 * MF 220A * 220CBD * 220STD * MF 310CBD * 310STD * 210 * 210S * 220 * 310	Câmbio / Caja de Cambios / Gearbox
			FNH	Colheitadeiras 4040 * 5030 * 5050 * 8040 * 8055 * TC55 * TC57 * CA1530	
			VALTRA - VALMET	Tratores 110 ID * 110ID II * 118 * 118 (4x4) * 128 * 128 (4x4)	
				Tratores 1280 * 1284 * 1580 * 1780 * 1780 (4x4) * 1380 * 1680 * 1880 * 118 * 128 * 138 * 148* 148 (4x4)	Tomada de Potência / Toma de Potencia / Power Take-off
			AGCO MAXION	Colhedeira Combinada Automotriz 1170DS * 1175DS * 630 Arroeira * 3640 Arroeira * 5650 * MF 220A * 220CBD * 220STD * MF 310CBD * 310STD * 210 * 210S * 220 * 310	Batedor Traseiro / Bastidor Traseiro / Rear Chassis
6309 2RS	BB			Cilindro de Dentes / Cilindro de Dientes	
				Conjunto da Trilha / Conjunto de Camino / Trail group	
				Embreamento / Embrague / Clutch	
				Tomada de Potência / Toma de Potencia / Power Take-off	
				Variador de Tração / Variador de Tracción / Traction Variable Drive	
			FNH	Colheitadeiras 4040 * 5030 * 5050 * 8040 * 8055 * TC55 * TC57 * CA1530	Batedor / Bastidor / Chassis
					Cilindro Côncavo de Barras / Cilindro Côncavo de Barras / Bars Concave Cylinder
6309 NR	BB		FORD	Cargo 814 Cargo 815 * 815 E F 100 (61...80 Diesel) * F 600 (56...77 Gas.) * F 700 (77...80) * F 750 (72...77) * 750 * 2000 * 4000	Caixa de Mudanças / Caja de Cambios / Gearbox
			GENERAL MOTORS	A-C-D 60* 70* 80* 90* 99 Turbo e 3500 Heavy Duty	
6309 NR / C3	BB		SCANIA	110 (B) K 94 IB (4X2)	Caixa de Mudanças / Caja de Cambios / Gearbox
			SCANIA	P 94 CB (4x2 * 6x2 * 6X4) P 94 GA*GB (4X2)	
6309 Z / C3	BB		MERCEDES BENZ	321 H (O) * 321 HL (O) (58...71)	Caixa de Mudanças / Caja de Cambios / Gearbox
			MERCEDES BENZ	321 (LAP*LAPK*LAPS*LP* LPK*LPS) 51...71	
6309 ZNR / C3	BB		SCANIA	101 (L*LS) * 111 (B) * 111 Articulado (B)	Caixa de Mudanças / Caja de Cambios / Gearbox
				110 (B)	
				110 (L*LS)	
		115 * 116 BR			
			SCANIA	75 * 76 B*L*LS	
6310	BB		FIAT	180 C * C3 * L * N * N3 (71...)	Caixa de Mudanças / Caja de Cambios / Gearbox
				FNM D-11000 (58...72)	
				FNM D-9500 (50...57)	
				Cardan / Cardan / Cardan	













Fersa®			Brand / Marca / Marca	Model / Modelo / Modelo	Application / Aplicação / Aplicaciones		
6310	BB		VOLVO	N * NL 10 BR * N * NL 12 BR * N 10BR Mark II * NL 10BR 6x2	Eixo Traseiro / Eje Trasero / Rear Axle		
			AGCO MAXION	Colheteadeira Combinada Automotriz 1170DS * 1175DS * 1630 Arrozeira * 3640 Arrozeira * 5650 * MF 220A * 220CBD * 220STD * MF 310CBD * 310STD * 210 * 210S * 220 * 310	Eixo Dianteiro / Eje Delantero / Front Axle		
			FNH	Colheteadeiras 4040 * 5030 * 5050 * 8040 * 8055 * TC55 * TC57 * CA1530	Câmbio / Caja de Cambios / Gearbox		
6310 2RS	BB		FIAT	190 (77...)	Embreagem / Embrague / Clutch		
			AGCO MAXION	Colheteadeira Combinada Automotriz 1170DS * 1175DS * 1630 Arrozeira * 3640 Arrozeira * 5650 * MF 220A * 220CBD * 220STD * MF 310CBD * 310STD * 210 * 210S * 220 * 310	Batedor Traseiro / Bastidor Traseiro / Rear Chassis		
6310 C3	BB		MERCEDES BENZ	331 (L*LPK*LPS) 60...68	Caixa de Mudanças / Caja de Cambios / Gearbox		
6311	BB		SCANIA	K 94 IB (4X2)	Caixa de Mudanças / Caja de Cambios / Gearbox		
			FIAT	180 C * C3 * L * N * N3 (71...) FNM D-11000 (58...72) FNM D-9500 (50...57)	Caixa de Mudanças / Caja de Cambios / Gearbox		
			SCANIA	75 * 76 B*L*LS P 94 CB (4x2 * 6x2 * 6X4) P 94 GA*GB (4X2) R 112 (81...)	Caixa de Mudanças / Caja de Cambios / Gearbox		
6311 C3	BB		AGCO MAXION	Colheteadeira Combinada Automotriz 1170DS * 1175DS * 1630 Arrozeira * 3640 Arrozeira * 5650 * MF 220A * 220CBD * 220STD * MF 310CBD * 310STD * 210 * 210S * 220 * 310 Tratores MF 235 (4x4) Antigo * MF 235 Moderno* 250 * 265 * MF265 RD * 270 * 274 * 275 * 285 * 290 * MF 292 (4x4) * 295 * 296 * 299	Caixa de Mudanças / Caja de Cambios / Gearbox Diferencial / Diferencial / Differential		
			FNH	Colheteadeiras 4040 * 5030 * 5050 * 8040 * 8055 * TC55 * TC57 * CA1530	Câmbio / Caja de Cambios / Gearbox		
6311 NR / C3	BB		SCANIA	110 (B) K 94 IB (4X2)	Caixa de Mudanças / Caja de Cambios / Gearbox		
			SCANIA	75 * 76 B*L*LS P 94 CB (4x2 * 6x2 * 6X4) P 94 GA*GB (4X2)			
6312 C3	BB		SCANIA	K 124 CA (6x4 * 6x2)	Caixa de Mudanças / Caja de Cambios / Gearbox		
			MERCEDES BENZ	1819 (L*LAK*LB*LG*LK*LS) * 1820 LG 2213 (L*LB*LK*LS) * 2213 6X6 (LA) * 2214 * 2215 (L*LB*LK*LS) * 2216 (L*LA*LAK*LB*LG*LK*LS) * 2217 (L*LB*LK*LS) * 2219 (L*LA*LAK*LB*LG*LK*LS) * 2220 * 2222 * 2225 (L*LB*LK*LS) 2314 (L*LB*LK*LS) * 2318 (L*LB*LK*LS) * 2325 (L*LB*LK*LS) 2414 (6X4) * 2414 (L) * 2418 (L*LB*LK) * 2420 (L*LB*LK) * 2423 B 6X4 * 2423 K 6X4 * 2425 6X6 (LA) * 2425 (L*LB*LK) * 2428 6X4 2629 LS 2635 (L*LK*LS)	Eixo Traseiro / Eje Trasero / Rear Axle		
				SCANIA	P 114 * R 124 * T 114 CB 6x4 * 4x2 * T 124 P 94 CB (4x2 * 6x2 * 6X4) 941 * 94H * 94U * P94 CB (6x4*4x2) * 114L * P114 * T114 CB (6x4*4x2) * 124E * R124 * K124 CA (6x4*6x2) * T124 * P124 CA * CB (6x4*4x2) * 164 * P230 * P270 * P310 * P340 * P420 * R380 * R420 * R480	Caixa de Mudanças / Caja de Cambios / Gearbox	
6312 NR / C3	BB		SCANIA	110 (B) 110 (L*LS)	Caixa de Mudanças / Caja de Cambios / Gearbox		
6313 C3	BB		MERCEDES BENZ	2635 (L*LK*LS)	Eixo Traseiro / Eje Trasero / Rear Axle		
6314	BB		MERCEDES BENZ	1517 OH * 1518 OH * 1519 OH * 1520 OH * 1521 OH 1721 L (OH)	Caixa de Mudanças / Caja de Cambios / Gearbox		
			MERCEDES BENZ	1513 (L*LA*LAK*LB*LG*LK*LS) * 1514 (L*LK*LS) * 1516 (L*LA*LAK*LB*LG*LK*LS) * 1517 (L*LK) * 1518 (L*LK*LS) * 1519 (L*LAK*LB*LG*LK*LS) * 1520 (L*LK*LP*LPK*LPS*LS) * 1521 L * 1524 e 1525 (L*LK*LS) 1517 OF * 1518 OF * 1520 OF 1714 OF * 1721 OF * 1722 OF 1714 * 1714 (L*K*LK) * 1715 * 1718 * 1718 (A * AK) * K * 1720 L * 1721 * 1721 S * 1721 (L*LK) * 1722 S * 1723 * 1723 S * 1725 L	Caixa de Mudanças / Caja de Cambios / Gearbox		
	MERCEDES BENZ	1517 OF * 1518 OF * 1520 OF 1714 OF * 1721 OF * 1722 OF	Caixa de Mudanças / Caja de Cambios / Gearbox				









Fersa®			Brand / Marca / Marca	Model / Modelo / Modelo	Application / Aplicação / Aplicaciones	
6314 C3	BB		MERCEDES BENZ	1618 OF	Caixa de Mudanças / Caja de Cambios / Gearbox	
				1620 OF * 1621 OF		
				1714 OF * 1721 OF * 1722 OF		
			MERCEDES BENZ	1621 L (OH) * 1623 LG (OH) * 1625 (OH) * 1625 L (OH) * 1628 L (OH) * 1630L (OH) * 1635 (OH) * 1636 L (OH)		
				1721 L (OH)		
				370 RS*RSD*RST* ST*U*UP (O) * 371 RS*RSD*RST* ST*U*UP (O)		
			MERCEDES BENZ	1614 * 1615 (L*LK*LS) * 1615 * 1618 M * 1618 (L*LK*LS) * 1619 (L)		
				1618 OF		
				1620(L*LK*LS) * 1620 6X2 51 (L) * 1621 (L*LK*LS) * 1622(L*LK*LS) * 1623 (L*LS) * 1625(L*LK*LS) * 1630 (L*LK*LS) * 1632 (L*LS) * 1633(L*LK*LS) * 1634 (L*LS) * 1635 L		
				1620 OF * 1621 OF		
				1714 OF * 1721 OF * 1722 OF		
				1714 * 1714 (L*K*LK) * 1715 * 1718 * 1718 (A * AK) * K * 1720 L * 1721 * 1721 S * 1721 (L*LK) * 1722 S * 1723 * 1723 S * 1725 L		
1819 (L*LAK*LB*LG*LK*LS) * 1820 LG						
1924 (LS) * 1924 A (LS) * 1929 (L*LK*LS) * 1930 (LS) * 1932 (LS) * 1933 (LS) * 1934 (LS) * 1935 (L*LS) * 1938 * 1938 S * 1938 (L*LS) * 1941 (L*LS) * 1944 S * 1945 (L*LS)						
1945 (L*LS)						
6314 N / C3	BB		MERCEDES BENZ	1517 OH * 1518 OH * 1519 OH * 1520 OH * 1521 OH	Caixa de Mudanças / Caja de Cambios / Gearbox	
			VOLVO	B 10M BR B 58 BR (...Chassi 304120)		
			MERCEDES BENZ	1513 (L*LA*LAK*LB*LG*LK*LS) * 1514 (L*LK*LS) * 1516 (L*LA*LAK*LB*LG*LK*LS) * 1517 (L*LK) * 1518 (L*LK*LS) * 1519 (L*LAK*LB*LG*LK*LS) * 1520 (L*LK*LP*LK*LP*LS) * 1521 L * 1524 e 1525 (L*LK*LS)		
				1517 OF * 1518 OF * 1520 OF		
				1819 (L*LAK*LB*LG*LK*LS) * 1820 LG		
				2213 (L*LB*LK*LS) * 2213 6X6 (LA) * 2214 * 2215 (L*LB*LK*LS) * 2216 (L*LA*LAK*LB*LG*LK*LS) * 2217 (L*LB*LK*LS) * 2219 (L*LA*LAK*LB*LG*LK*LS) * 2220 * 2222 * 2225 (L*LB*LK*LS)		
				1517 OF * 1518 OF * 1520 OF		
				MERCEDES BENZ		1517 OF * 1518 OF * 1520 OF
				1517 OF * 1518 OF * 1520 OF		
		6314 NR / C3	BB			SCANIA
110 (L*LS)						
111 (L*LS*LT)						
140 (LK*LKS)						
	FIAT			FNM 210 C * CM * LN (71...76)		
		FNM V-15 (69...74)				
6386 / 6320	BB		VOLVO	B 58	Eixo Dianteiro / Eje Delantero / Front Axle	
				B 58 BR (...Chassi 304120)		
			VOLVO	B 10R * B 12B * B 12R * B 58 * B 58BR * B 7R * B9		
				FH 12 * FH 16		
6403 2RS / C3	BB		MERCEDES BENZ	1113 (LPO*OH) * 1114 LPO * 1115 L (OH) * 1118 LPO	Motor / Motor / Engine	
				1313 OH * 1314 OH * 1315 OH * 1316 (OH*OHL) * 1316 G (OH*OHL) * 1317 OH * 1318 OH * 1319 OH * 1320 (OH*OHL)		
				1418 OH * 1419 OH * 1420 (OH*OHL) * 1421 OHL		
				1517 OH * 1518 OH * 1519 OH * 1520 OH * 1521 OH		
				1621 L (OH) * 1623 LG (OH) * 1625 (OH) * 1625 L (OH) * 1628 L (OH) * 1630L (OH) * 1635 (OH) * 1636 L (OH)		
				1721 L (OH)		
				326 O		
				352 HL (O) (...74)		
				355 O		
						FORD
		Cargo 1215				
		Cargo 1313 * 1314 * 1317 * 1317E				
		Cargo 1415 * 1416				
		Cargo 1422 * 1514 * 1517 * 1517E * 1615 * 1615T * 1617 * 1618 * 1618T * 1619 * 1621 * 1622 * 1717E * 1722 * 1722E * 2216 * 2217 * 2218 * 2218T * 2319 * 2322 * 2324 * 2422 * 2422E * 2425 * 2428E * 2630 * 3224 * 3530 * 4030				
F 19000 (77...) * F 21000 * F 22000						









Fersa®			Brand / Marca / Marca	Model / Modelo / Modelo	Application / Aplicação / Aplicaciones
6403 2RS / C3	BB		MERCEDES BENZ	1113 (L*LA*LAK*LAS*LK*LP*LS*LP) * 1114 * 1114 (L*LK*LP) * 1116 (L*LA*LAK*LAS*LB* LK*LS) * 1118 (L*LK*LP)	Motor / Motor / Engine
				1113 OF * 1115 OF	
				1214 C * 1214 K * 1214 (L*LK*LS) * 1215 * 1215 C * 215 (L*LA*LK) * 1218 * 1218 R (L)	
				1215 OF * 1217 OF	
				1313 (L*LA*LAK*LB*LK*LS) * 1314 (L*LA*LAK*LB*LK*LS) * 1316 (L*LA*LAK*LAS*LB*LK*LS) * 1317 (L*LA*LAK*LK*LS)* 1319 (L)	
				1313 OF * 1314 OF * 1315 OF * 1316 OF * 1317 OF * 1318 OF * 1319 OF * 1320 OF	
				1414 * 1414 (K*L*LA*LAK*LK) * 1418 * 1418 (E*K*R) * 1418 (L*LA*LAK*LK*R(LK)) * 1419 (L*LK*LS) * 1420 (L*LK*LS)	
				1417 OF * 1419 OF * 1421 OF	
				1421 OMC	
				1513 (L*LA*LAK*LB*LG*LK*LS) * 1514 (L*LK*LS) * 1516 (L*LA*LAK*LB*LG*LK*LS) * 1517 (L*LK) * 1518 (L*LK*LS) * 1519 (L*LAK*LB*LG*LK*LS) * 1520 (L*LK*LP*LPK*LPS*LS) * 1521 L * 1524 e 1525 (L*LK*LS)	
				1517 OF * 1518 OF * 1520 OF	
				1620(L*LK*LS) * 1620 6X2 51 (L) * 1621 (L*LK*LS) * 1622(L*LK*LS) * 1623 (L*LS) * 1625(L*LK*LS) * 1630 (L*LK*LS) * 1632 (L*LS) * 1633(L*LK*LS) * 1634 (L*LS) * 1635 L	
				1620 OF * 1621 OF	
				1714 OF * 1721 OF * 1722 OF	
				1714 * 1714 (L*K*LK) * 1715 * 1718 * 1718 (A * AK) * K * 1720 L * 1721 * 1721 S * 1721 (L*LK) * 1722 S * 1723 * 1723 S * 1725 L	
		2213 (L*LB*LK*LS) * 2213 6X6 (LA) * 2214 * 2215 (L*LB*LK*LS) * 2216 (L*LA*LAK*LB*LG*LK*LS) * 2217 (L*LB*LK*LS) * 2219 (L*LA*LAK*LB*LG*LK*LS) * 2220 * 2222 * 2225 (L*LB*LK*LS)			
		2314 (L*LB*LK*LS) * 2318 (L*LB*LK*LS) * 2325 (L*LB*LK*LS)			
		2414 (6X4) * 2414 (L) * 2418 (L*LB*LK) * 2420 (L*LB*LK) * 2423 B 6X4 * 2423 K 6X4 * 2425 6X6 (LA) * 2425 (L*LB*LK) * 2428 6X4			
		SCANIA	112 (F*K*S)		
			MERCEDES BENZ	1113 OF * 1115 OF	
				1215 OF * 1217 OF	
				1313 OF * 1314 OF * 1315 OF * 1316 OF * 1317 OF * 1318 OF * 1319 OF * 1320 OF	
				1417 OF * 1419 OF * 1421 OF	
				1421 OMC	
				1517 OF * 1518 OF * 1520 OF	
				1620 OF * 1621 OF	
				1714 OF * 1721 OF * 1722 OF	
6403 C3	BB		MERCEDES BENZ	1618 OF	Motor / Motor / Engine
			MERCEDES BENZ	362 O 364 O	
			MERCEDES BENZ	1614 * 1615 (L*LK*LS) * 1615 * 1618 M * 1618 (L*LK*LS) * 1619 (L) 1618 OF	
6407 C3	BB		SCANIA	110 (B) K 94 IB (4X2)	Caixa de Mudanças / Caja de Cambios / Gearbox
			SCANIA	75 * 76 B*L*LS P 94 CB (4x2 * 6x2 * 6X4) P 94 GA*GB (4X2)	
6408	BB		FIAT	180 C * C3 * L* N * N3 (71...)	Eixo Traseiro / Eje Trasero / Rear Axle
				FNM D-11000 (58...72)	Caixa de Mudanças / Caja de Cambios / Gearbox
				FNM D-9500 (50...57)	
6408 NR / C3	BB		SCANIA	110 (B)	Caixa de Mudanças / Caja de Cambios / Gearbox
				115 * 116 BR	
6409	BB		FIAT	FNM D-11000 (58...72) FNM D-9500 (50...57)	Caixa de Mudanças / Caja de Cambios / Gearbox







Fersa®			Brand / Marca / Marca	Model / Modelo / Modelo	Application / Aplicação / Aplicaciones				
6409 C3	BB		SCANIA	K 94 IB (4X2)	Caixa de Mudanças / Caja de Cambios / Gearbox				
			SCANIA	75 * 76 B*L*LS P 94 CB (4x2 * 6x2 * 6X4) P 94 GA*GB (4X2)					
			SCANIA	P 94 CB (4x2 * 6x2 * 6X4) P 94 GA*GB (4X2)					
6409 NR / C3	BB		SCANIA	K 94 IB (4X2)	Caixa de Mudanças / Caja de Cambios / Gearbox				
			SCANIA	75 * 76 B*L*LS P 94 CB (4x2 * 6x2 * 6X4) P 94 GA*GB (4X2)					
			SCANIA	P 94 CB (4x2 * 6x2 * 6X4) P 94 GA*GB (4X2)					
641 / 632	TRB		FAMSA	DC 9964 Autocar	Eixo Traseiro / Eje Trasero / Rear Axle				
6411 NR / C3	BB		SCANIA	101 (L*LS) * 111 (B) * 111 Articulado (B) 110 (B) 115 * 116 BR K 94 IB (4X2)	Caixa de Mudanças / Caja de Cambios / Gearbox				
			SCANIA	75 * 76 B*L*LS P 94 CB (4x2 * 6x2 * 6X4) P 94 GA*GB (4X2)					
			SCANIA	P 94 CB (4x2 * 6x2 * 6X4) P 94 GA*GB (4X2)					
			SCANIA	101 (L*LS) * 111 (B) * 111 Articulado (B) 110 (B) 110 (L*LS) 115 * 116 BR					
			VOLVO	9700					
			STERLING	L7500					
6461A / 6420	TRB		FAMSA	DC 9964 Autocar	Eixo Dianteiro / Eje Delantero / Front Axle				
			FORD	LT-800					
			FREIGHTLINER	FL 112 6X4 FL 112QR 6X4					
				KENWORTH		T800 * Aerocab * Modular * SHW (Short hood wide) * HB * BSH Aerocab * SH 6X4 * 8X4 W900 * W924			
			MACK	CH Day Cab * CH Premium * CH Select * CH Elite * CX Vision RD688S * RD690					
				STERLING		LT7500 LT9500			
			VOLVO	Autocar / VHD 64B 6X4 NE 64 6X4 * NR 64 T WG 64					
				DINA		F11 * F12 * F14 Marco Polo Viaggio			
			65237 / 65500	TRB			DINA	751 Multi Torque 861 K	Eixo Traseiro / Eje Trasero / Rear Axle
							FAMSA	DC 10264 Autocar DC 9964 Autocar	
FORD	LT-800								
FREIGHTLINER	FLD 120 FS 65								
	KENWORTH	T2000 T 600 Aerocab, B, Modular T800 * Aerocab * Modular * SHW (Short hood wide) * HB * BSH Aerocab * SH 6X4 * 8X4 W900 * W924							
DINA		761							
MASA		S500T * S500U * S501U							
663 / 653	TRB				VOLVO		7550 9700 B 10M BR B 10R * B 12B * B 12R * B 58 * B 58BR * B 7R *B9	Eixo Traseiro / Eje Trasero / Rear Axle	







Fersa®			Brand / Marca / Marca	Model / Modelo / Modelo	Application / Aplicação / Aplicaciones			
663 / 653	TRB		VOLVO	B 58 B 58 BR (...Chassi 304120)	Eixo Traseiro / Eje Trasero / Rear Axle			
			VOLVO	B 10R * B 12B * B 12R * B 58 * B 58BR * B 7R * B9 FH 12 * FH 16 N * NL 10 BR * N * NL 12 BR * N 10BR Mark II * NL 10BR 6x2 NH 12 * FM 12				
								
665 / 652	TRB		MASA	S500T * S500U * S501U	Eixo Traseiro / Eje Trasero / Rear Axle			
665 / 653	TRB		MASA	S500T * S500U * S501U	Eixo Traseiro / Eje Trasero / Rear Axle			
681 A / 672	TRB		MASA	S 5000 * S 5002 * S 2030	Eixo Traseiro / Eje Trasero / Rear Axle			
			FAMSA	DC 10264 Autocar				
683 / 672	TRB		VOLVO	7550 9700 B 10M BR B 10R * B 12B * B 12R * B 58 * B 58BR * B 7R * B9 B 58 B 58 BR (...Chassi 304120)	Eixo Traseiro / Eje Trasero / Rear Axle			
						VOLVO	FH 12 * FH 16 N * NL 10 BR * N * NL 12 BR * N 10BR Mark II * NL 10BR 6x2 NH 12 * FM 12	
						MASA	S500T * S500U * S501U	Eixo Traseiro / Eje Trasero / Rear Axle
								
		68462 / 68712	TRB			FORD	Cargo 1422 * 1514 * 1517 * 1517E * 1615 * 1615T * 1617 * 1618 * 1618T * 1619 * 1621 * 1622 * 1717E * 1722 * 1722E * 2216 * 2217 * 2218 * 2218T * 2319 * 2322 * 2324 * 2422 * 2422E * 2425 * 2428E * 2630 * 3224 * 3530 * 4030	Eixo Traseiro / Eje Trasero / Rear Axle
687 / 672	TRB		VOLVO	7550 B 10M BR B 10R * B 12B * B 12R * B 58 * B 58BR * B 7R * B9 B 58 B 58 BR (...Chassi 304120)	Eixo Traseiro / Eje Trasero / Rear Axle			
						VOLVO	FH 12 * FH 16 N * NL 10 BR * N * NL 12 BR * N 10BR Mark II * NL 10BR 6x2 NH 12 * FM 12	
7210 B	BB	References Fersa with Multiple Applications / Referências Fersa com Múltiplas Aplicações / Referencias Fersa con Multiples Aplicaciones						
72188 C / 72487	TRB		CHRYSLER	D-600 * PD-600	Eixo Traseiro / Eje Trasero / Rear Axle			
			DINA	702 * 707 761				
			FORD	F-600 * B-600				
			MERCEDES BENZ	L2221				
72200 C / 72487	TRB		FORD	B-800	Eixo Traseiro / Eje Trasero / Rear Axle			
			CHRYSLER	D-600 * PD-600				
			DINA	400 Serie 604 G1 * 604 G3 * 604 L1 * 604 L5 * 631 K1 * 631 K3 * 661 C1 * 661 G1 * 661 G2 * 661 G3 702 * 707 761				
				FAMSA		F 1521 L1100, L1200, L1300, L1400, L1500, L1600, L2121		
				FORD		F-600 * B-600 F-700		
			GENERAL MOTORS	C-3500				
			MERCEDES BENZ	L1214 * L1215 * L1217 39 * L1217 52 * L1218 52 L1417 52 L1418 39 * L1418 52 * L1418 60 * L1419 59 * L1420. L1422 L1518 52 L1617 59				













Fersa®			Brand / Marca / Marca	Model / Modelo / Modelo	Application / Aplicação / Aplicaciones	
72200 C / 72487	TRB		MERCEDES BENZ	L1619 52	Eixo Traseiro / Eje Trasero / Rear Axle	
				L1621 52		
				L2121 54		
				LK1417 34		
				MBO 1217		
				MBO 1417		
				MBO 1418 60		
				MBO 1419 60 Boxer		
				MBO 1621		
				OMC 1418 51 * OMC 1418 60		
				OMC 1423 51 Torino		
LO 1417 59						
72212 C / 72487	TRB		DINA	D-Avante Plus * D-Dorado	Eixo Traseiro / Eje Trasero / Rear Axle	
				Viaggio		
			MASA	S500T * S500U * S501U		
			VOLVO	C 11R * C 12R		
			DINA	300 HTQ Serie		Eixo Traseiro / Eje Trasero / Rear Axle
				604 G1 * 604 G3 * 604 L1 * 604 L5 * 631 K1 * 631 K3 * 661 C1 * 661 G1 * 661 G2 * 661 G3		
			FAMSA	F 1314 * F 1317		
			FREIGHTLINER	FC 70		
				FC 80		
				FL 112QR 6X4		
		INTERNATIONAL	4400-215HP 4X2 * 4400-250HP * 4400-285HP * 4400-300HP			
KENWORTH	T300 4X2 * 6X4					
72218 C / 72487	TRB		MERCEDES BENZ	L2221	Eixo Traseiro / Eje Trasero / Rear Axle	
749 / 742	TRB		FAMSA	DC 9964 Autocar	Eixo Traseiro / Eje Trasero / Rear Axle	
760 / 752	TRB		FAMSA	DC 9964 Autocar	Eixo Traseiro / Eje Trasero / Rear Axle	
78215 C / 78551	TRB		MASA	S500T * S500U * S501U	Eixo Traseiro / Eje Trasero / Rear Axle	
			DINA	300 HTQ Serie		
			CHRYSLER	Ram 6500		
			FORD	Cargo 1422 * 1514 * 1517 * 1517E * 1615 * 1615T * 1617 * 1618 * 1618T * 1619 * 1621 * 1622 * 1717E * 1722 * 1722E * 2216 * 2217 * 2218 * 2218T * 2319 * 2322 * 2324 * 2422 * 2422E * 2425 * 2428E * 2630 * 3224 * 3530 * 4030		
				LM-700		
			FREIGHTLINER	FC 80		
				FL 70		
			INTERNATIONAL	4400-215HP 4X2 * 4400-250HP * 4400-285HP * 4400-300HP		
IVECO	160 E21					
9278 / 9220	TRB		DINA	434 17570 Shuttle Bus	Eixo Traseiro / Eje Trasero / Rear Axle	
			MASA	Ursus		
			MOTOR COACH	F12		
				P14		
			VOLVO	Busscar dos y tres ejes		
				U 12 * U 18 Articulado		
			DINA	776		
STERLING	L7500					
9285 / 9220	TRB		VOLVO	7550	Eixo Traseiro / Eje Trasero / Rear Axle	
				B 10M BR		
				B 10R * B 12B * B 12R * B 58 * B 58BR * B 7R * B9		
				B 58 BR (...Chassi 304120)		
A 6075 / A 6157	TRB	References Fersa with Multiple Applications / Referências Fersa com Múltiplas Aplicações / Referencias Fersa con Múltiples Aplicaciones				
F 15029	TRBS		FORD	Courier	Eixo Traseiro / Eje Trasero / Rear Axle	
				Fiesta		
				Ikon		
				Microbus		





Fersa®			Brand / Marca / Marca	Model / Modelo / Modelo	Application / Aplicação / Aplicaciones
F 15036	TRBS		FORD	Escort	Eixo Dianteiro / Eje Delantero / Front Axle
				Escort Hobby	
				Verona	
			VOLKSWAGEN	Apollo	
F 15041	TRBDR		CITROËN	AX * ZX	Eixo Traseiro / Eje Trasero / Rear Axle
				C3	
				Xsara	
			NISSAN	Aprio	
				Micra	
				Platina	
			PEUGEOT	205	
				206	
				306	
			RENAULT	Clio	
F 15043	TRBDR		MERCEDES BENZ	Classe A	Eixo Traseiro / Eje Trasero / Rear Axle
F 15044	TRBDR	References Fersa with Multiple Applications / Referências Fersa com Múltiplas Aplicações / Referencias Fersa con Múltiples Aplicaciones			
F 15046	TRBS		SCANIA	101 (L*LS) * 111 (B) * 111 Articulado (B)	Eixo Traseiro / Eje Trasero / Rear Axle
				110 (B)	
				110 (L*LS)	
				111 (L*LS*LT)	
				115 * 116 BR	
				140 (LK*LKS)	
				K 113	
		P 93 * R 113 * R 143* T 113			
		T 113 H (6X4) Paradiso			
			SCANIA	112 (F*K*S)	
				F 113 * L 113 * K 113	
				P 114 GA (4X2) * R 114 GA (4X2 * 6X4) * T 114 GA (4X2) * T 114 LA (6X2)	
				R 112 (81...)	
				R 142 MA (4X2)(81...)	
T 142 E (6X4)					
F 15047	TRBS		MAN	18-260 * 310 * 360 * 410 * 460	Caixa de Mudanças / Caja de Cambios / Gearbox
			MASA	Jaguar * Condor * Géminis * Halcón * Strada * Premier 2030F	
			MERCEDES BENZ	1621 L (OH) * 1623 LG (OH) * 1625 (OH) * 1625 L (OH) * 1628 L (OH) * 1630L (OH) * 1635 (OH) * 1636 L (OH)	
				1721 L (OH)	
				370 RS*RSD*RST* ST*U*UP (O) * 371 RS*RSD*RST* ST*U*UP (O)	
				400 (R * RS * RSD * RSL) (O)	
				Multego IBC 1842 * IBC 2242 * OC 500	
				O 371 R * O 371 RS * O 371 RSD	
				O 400 R * O 400 RS * O 400 RSD * O 400 RSE * O 400 RSL * MP 105 * MP 108 DD * MP120 * MP 180 DD	
			VOLVO	B 10M BR	
		B 58 BR (...Chassi 304120)			
			IVECO	Eurotrakker * Power Star 450 E37T * Eurotech E37	
			MERCEDES BENZ	1614 * 1615 (L*LK*LS) * 1615 * 1618 M * 1618 (L*LK*LS) * 1619 (L)	
				1618 OF	
				1620(L*LK*LS) * 1620 6X2 51 (L) * 1621 (L*LK*LS) * 1622(L*LK*LS) * 1623 (L*LS) * 1625(L*LK*LS) * 1630 (L*LK*LS) * 1632 (L*LS) * 1633(L*LK*LS) * 1634 (L*LS) * 1635 L	
				1620 OF * 1621 OF	
				1714 OF * 1721 OF * 1722 OF	
				1714 * 1714 (L*K*LK) * 1715 * 1718 * 1718 (A * AK) * K * 1720 L * 1721 * 1721 S * 1721 (L*LK) * 1722 S * 1723 * 1723 S * 1725 L	
				1924 (LS) * 1924 A (LS) * 1929 (L*LK*LS) * 1930 (LS) * 1932 (LS) * 1933 (LS) * 1934 (LS) * 1935 (L*LS) * 1938 * 1938 S * 1938 (L*LS) * 1941 (L*LS) * 1944 S * 1945 (L*LS)	













Fersa*			Brand / Marca / Marca	Model / Modelo / Modelo	Application / Aplicação / Aplicaciones
F 15047	TRBS		MERCEDES BENZ	2213 (L*LB*LK*LS) * 2213 6X6 (LA) * 2214 * 2215 (L*LB*LK*LS) * 2216 (L*LA*LAK*LB*LG*LK*LS) * 2217 (L*LB*LK*LS) * 2219 (L*LA*LAK*LB*LG*LK*LS) * 2220 * 2222 * 2225 (L*LB*LK*LS)	Caixa de Mudanças / Caja de Cambios / Gearbox
				2414 (6X4) * 2414 (L) * 2418 (L*LB*LK) * 2420 (L*LB*LK) * 2423 B 6X4 * 2423 K 6X4 * 2425 6X6 (LA) * 2425 (L*LB*LK) * 2428 6X4	Eixo Traseiro / Eje Trasero / Rear Axle
				Axor 2625 * 2628 * 2629 (LK*LS) * 2631 (B*K*L) * 2632 * 2635 (B*K*L) * 2635 (L*LK*LS) * 2635 * 2638 (L*LK*LS) * Axor 2640 * 2641 * 2643 * Axor 2644 * Actos 2646 * 2648 * 2650 * 2651 * 2653 * 2654 (L*LK*LS) * 2657 * 2658 * 2644 * Atego 2628 (B*K) * 2625 * Axor 2826 * Axor 2828 * Axor 2831	Caixa de Mudanças / Caja de Cambios / Gearbox
				2635 (L*LK*LS)	
				L1924 * L1929 * L1930 * L1932 * L1933 * L1934 * L1935 * L1937 * L1938 * L1939 * L1941 * L1942 * L1944 * L1945 * L1951	
				SCANIA	
		VOLVO	FH 12 * FH 16 N * NL 10 BR * N * NL 12 BR * N 10BR Mark II * NL 10BR 6x2 NH 12 * FM 12		
		1618 OF			
			MERCEDES BENZ	1620 OF * 1621 OF	
				1714 OF * 1721 OF * 1722 OF	
		F 15048	TRBS		SCANIA
	SCANIA				
					MERCEDES BENZ
	MERCEDES BENZ				













Fersa®			Brand / Marca / Marca	Model / Modelo / Modelo	Application / Aplicação / Aplicaciones					
F 15051 C	TRBS		MERCEDES BENZ	LK 1614 * LK 1615 * LK 1617 * LK 1618 * LK 1620 * LK 1621 * LK 1622 * LK 1623 * LK 1625 * LK 1630 * LK 1633 * LK 1634 LK 1714 * LK 1715 * LK 1718 * LK 1720 * LK 1721 * LK 1722 * LK 1723 * LK 1724 * LK 1728	Eixo Dianteiro / Eje Delantero / Front Axle					
				LK 2629 * LK 2635 * LK 2638 * LK 2654						
				LK 3238 6X4 KS						
				LS 1929 * LS 1930 * LS 1932 * LS 1933 * LS 1934 * LS 1935 * LS 1937 * LS 1938 * LS 1939 * LS 1941 * LS 1942 * LS 1944 * LS 1945 * LS 1951						
				LS 2013 * LS 2014 * LS 2016 * LS 2017 * LS 2024 * LS 2036 * LS 2042						
				LS 2629 * LS 2635 * LS 2638 * LS 2654						
				OF 1517 * OF 1518 * OF 1519 * OF 1520 * OF 1521 * OF 1524 * OF 1525						
				OF 1618 * OF 1620 * OF 1621 * OF 1625 * OF 1628 * OF 1630 * OF 1635 * OF 1636						
				OF 1714 * OF 1718 * OF 1721 * OF 1725						
				1618 OF						
		1714 OF * 1721 OF * 1722 OF								
			MERCEDES BENZ	OF 1517 * OF 1518 * OF 1519 * OF 1520 * OF 1521 * OF 1524 * OF 1525						
				OF 1618 * OF 1620 * OF 1621 * OF 1625 * OF 1628 * OF 1630 * OF 1635 * OF 1636						
				OF 1714 * OF 1718 * OF 1721 * OF 1725						
				References Fersa with Multiple Applications / Referências Fersa com Múltiplas Aplicações / Referencias Fersa con Multiples Aplicaciones						
				References Fersa with Multiple Applications / Referências Fersa com Múltiplas Aplicações / Referencias Fersa con Multiples Aplicaciones						
				F 15071		TRBS		VOLVO	FH 12 * FH 16	Eixo Traseiro / Eje Trasero / Rear Axle
									F 15076	
				F 15082		TRBS		MERCEDES BENZ		OH 1417 * OH 1418
									OH 1113	
OH 1419 * OH 1420 * OH 1421										
OH 1517 * OH 1518 * OH 1519 * OH 1520 * OH 1521										
L1214 * L1215 * L1217 39 * L1217 52 * L1218 52										
L1414 * L1416										
L1418 39 * L1418 52 * L1418 60 * L1419 59 * L1420. L1422										
L1617 59										
L1618										
L1621 54 * L1621 59 * L1621 60 * L1621 70 * L1622 * L1623 * L1625										
L1630 * L1632 * L1633 * L1634										
LK1418 39 * LK1418 52										
LK1420 * LK1422										
OF 1313 * OF 1314 * OF 1315 * OF 1316 * OF 1317 * OF 1318 51										
L 1524 * L 1525										
L 1614 * L 1615										
L 1620										
L 1714 * L 1715 * L 1718 * L 1720 * L 1721 * L 1722 * L 1723 * L 1724 * L 1728										
L 2414 * L 2418 * L 2420 * L 2423 * L 2424 * L 2428										
LAK1524 * LAK1525										
LB 1524 * LB 1525										
LG 1524 * LG 1525										
LK 1414 * LK 1416										
LK 1524 * LK 1525										
LK 1614 * LK 1615 * LK 1617 * LK 1618 * LK 1620 * LK 1621 * LK 1622 * LK 1623 * LK 1625 * LK 1630 * LK 1633 * LK 1634										
LK 1714 * LK 1715 * LK 1718 * LK 1720 * LK 1721 * LK 1722 * LK 1723 * LK 1724 * LK 1728										
LK 2414 * LK 2418 * LK 2420 * LK 2423 * LK 2424 * LK 2428 * LK 2429										
LP 1525 * LPK1525 * LPS1525 * LS 1525										
LS 1524 * LP1524 * LPK1524 * LPS1524										
OF 1215 * OF 1217										
OF 1320										



















Fersa*			Brand / Marca / Marca	Model / Modelo / Modelo	Application / Aplicação / Aplicaciones
F 15082	TRBS		MERCEDES BENZ	OF 1416 * OF 1417 * OF 1418 * OF 1419 * OF 1420 * OF 1421	Eixo Traseiro / Eje Trasero / Rear Axle
				OF 1517 * OF 1518 * OF 1519 * OF 1520 * OF 1521 * OF 1524 * OF 1525	
				OF 1618 * OF 1620 * OF 1621 * OF 1625 * OF 1628 * OF 1630 * OF 1635 * OF 1636	
				OF 1714 * OF 1718 * OF 1721 * OF 1725	
				OF 1313 * OF 1314 * OF 1315 * OF 1316 * OF 1317 * OF 1318 51	
			MERCEDES BENZ	OF 1215 * OF 1217	
				OF 1320	
				OF 1416 * OF 1417 * OF 1418 * OF 1419 * OF 1420 * OF 1421	
				OF 1517 * OF 1518 * OF 1519 * OF 1520 * OF 1521 * OF 1524 * OF 1525	
				OF 1618 * OF 1620 * OF 1621 * OF 1625 * OF 1628 * OF 1630 * OF 1635 * OF 1636	
OF 1714 * OF 1718 * OF 1721 * OF 1725					
F 15083	TRBS		MERCEDES BENZ	1313 OH * 1314 OH * 1315 OH * 1316 (OH*OHL) * 1316 G (OH*OHL) * 1317 OH * 1318 OH * 1319 OH * 1320 (OH*OHL)	Eixo Traseiro / Eje Trasero / Rear Axle
				1418 OH * 1419 OH * 1420 (OH*OHL) * 1421 OHL	
				1517 OH * 1518 OH * 1519 OH * 1520 OH * 1521 OH	
				1621 L (OH) * 1623 LG (OH) * 1625 (OH) * 1625 L (OH) * 1628 L (OH) * 1630L (OH) * 1635 (OH) * 1636 L (OH)	
				1721 L (OH)	
				OH 1113	
				OH 1419 * OH 1420 * OH 1421	
				OH 1517 * OH 1518 * OH 1519 * OH 1520 * OH 1521	
				1214 C * 1214 K * 1214 (L*LK*LS) * 1215 * 1215 C * 1215 (L*LA*LK) * 1218 * 1218 R (L)	
				1215 OF * 1217 OF	
				1313 (L*LA*LAK*LB*LK*LS) * 1314 (L*LA*LAK*LB*LK*LS) * 1316 (L*LA*LAK*LAS*LB*LK*LS) * 1317 (L*LA*LAK*LK*LS)* 319 (L)	
				1313 OF * 1314 OF * 1315 OF * 1316 OF * 1317 OF * 1318 OF * 1319 OF * 1320 OF	
				1414 * 1414 (K*L*LA*LAK*LK) * 1418 * 1418 (E*K*R) * 1418 (L*LA*LAK*LK*R(LK)) * 1419 (L*LK*LS) * 1420 (L*LK*LS)	
				1417 OF * 1419 OF * 1421 OF	
				1421 OMC	
				1513 (L*LA*LAK*LB*LG*LK*LS) * 1514 (L*LK*LS) * 1516 (L*LA*LAK*LB*LG*LK*LS) * 1517 (L*LK) * 1518 (L*LK*LS) * 1519 (L*LAK*LB*LG*LK*LS) * 1520 (L*LK*LP*LPK*LPS*LS) * 1521 L * 1524 e 1525 (L*LK*LS)	
				1517 OF * 1518 OF * 1520 OF	
				1614 * 1615 (L*LK*LS) * 1615 * 1618 M * 1618 (L*LK*LS) * 1619 (L)	
				1618 OF	
				1620(L*LK*LS) * 1620 6X2 51 (L) * 1621 (L*LK*LS) * 1622(L*LK*LS) * 1623 (L*LS) * 1625(L*LK*LS) * 1630 (L*LK*LS) * 1632 (L*LS) * 1633(L*LK*LS) * 1634 (L*LS) * 1635 L	
		1620 OF * 1621 OF			
		1714 OF * 1721 OF * 1722 OF			
		1714 * 1714 (L*K*LK) * 1715 * 1718 * 1718 (A * AK) * K * 1720 L * 1721 * 1721 S * 1721 (L*LK) * 1722 S * 1723 * 1723 S * 1725 L			
		2414 (6X4) * 2414 (L) * 2418 (L*LB*LK) * 2420 (L*LB*LK) * 2423 B 6X4 * 2423 K 6X4 * 2425 6X6 (LA) * 2425 (L*LB*LK) * 2428 6X4			
		L 1524 * L 1525			
		L 1614 * L 1615			
		L 1620			
		L 1714 * L 1715 * L 1718 * L 1720 * L 1721 * L 1722 * L 1723 * L 1724 * L 1728			
		L 2414 * L 2418 * L 2420 * L 2423 * L 2424 * L 2428			
		LA 1313 * LA 1314 * LA 1315 * LA 1316 * LA 1317 * LA 1318 * LA 1319 * LA 1320			
		LAK 1313 * LAK 1314 * LAK 1315 * LAK 1316 * LAK 1317 * LAK 1318 * LAK 1320			
		LAK1524 * LAK1525			
		LAS 1313 * LAS 1314 * LAS 1315 * LAS 1316 * LAS 1317 * LAS 1318 * LAS 1319 * LAS 1320			
			MERCEDES BENZ	1620(L*LK*LS) * 1620 6X2 51 (L) * 1621 (L*LK*LS) * 1622(L*LK*LS) * 1623 (L*LS) * 1625(L*LK*LS) * 1630 (L*LK*LS) * 1632 (L*LS) * 1633(L*LK*LS) * 1634 (L*LS) * 1635 L	
				1620 OF * 1621 OF	
				1714 OF * 1721 OF * 1722 OF	
				1714 * 1714 (L*K*LK) * 1715 * 1718 * 1718 (A * AK) * K * 1720 L * 1721 * 1721 S * 1721 (L*LK) * 1722 S * 1723 * 1723 S * 1725 L	
				2414 (6X4) * 2414 (L) * 2418 (L*LB*LK) * 2420 (L*LB*LK) * 2423 B 6X4 * 2423 K 6X4 * 2425 6X6 (LA) * 2425 (L*LB*LK) * 2428 6X4	
				L 1524 * L 1525	
				L 1614 * L 1615	
L 1620					
L 1714 * L 1715 * L 1718 * L 1720 * L 1721 * L 1722 * L 1723 * L 1724 * L 1728					
L 2414 * L 2418 * L 2420 * L 2423 * L 2424 * L 2428					
LA 1313 * LA 1314 * LA 1315 * LA 1316 * LA 1317 * LA 1318 * LA 1319 * LA 1320					
LAK 1313 * LAK 1314 * LAK 1315 * LAK 1316 * LAK 1317 * LAK 1318 * LAK 1320					
LAK1524 * LAK1525					
LAS 1313 * LAS 1314 * LAS 1315 * LAS 1316 * LAS 1317 * LAS 1318 * LAS 1319 * LAS 1320					











Fersa®			Brand / Marca / Marca	Model / Modelo / Modelo	Application / Aplicação / Aplicaciones
F 15083	TRBS		MERCEDES BENZ	LB 1314 * LB 1315 * LB 1316 * LB 1317 * LB 1318 * LB 1319 * LB 1320	Eixo Traseiro / Eje Trasero / Rear Axle
				LB 1524 * LB 1525	
				LG 1524 * LG 1525	
				LK 1313 * LK 1314 * LK 1315 * LK 1316 * LK 1317 * LK 1318 * LK 1319 * LK 1320 * LK 1321	
				LK 1414 * LK 1416	
				LK 1524 * LK 1525	
				LK 1614 * LK 1615 * LK 1617 * LK 1618 * LK 1620 * LK 1621 * LK 1622 * LK 1623 * LK 1625 * LK 1630 * LK 1633 * LK 1634	
				LK 1714 * LK 1715 * LK 1718 * LK 1720 * LK 1721 * LK 1722 * LK 1723 * LK 1724 * LK 1728	
				LK 2414 * LK 2418 * LK 2420 * LK 2423 * LK 2424 * LK 2428 * LK 2429	
				LP 1525 * LPK1525 * LPS1525 * LS 1525	
				LS 1314 * LS 1315 * LS 1316 * LS 1317 * LS 1318 * LS 1319	
				LS 1524 * LP1524 * LPK1524 * LPS1524	
				OF 1320	
				OF 1416 * OF 1417 * OF 1418 * OF 1419 * OF 1420 * OF 1421	
OF 1517 * OF 1518 * OF 1519 * OF 1520 * OF 1521 * OF 1524 * OF 1525					
OF 1618 * OF 1620 * OF 1621 * OF 1625 * OF 1628 * OF 1630 * OF 1635 * OF 1636					
OF 1714 * OF 1718 * OF 1721 * OF 1725					
F 15097	HWT		SCANIA	Série 4 (4x2)	Eixo Dianteiro / Eje Delantero / Front Axle
References Fersa with Multiple Applications / Referências Fersa com Múltiplas Aplicações / Referencias Fersa con Múltiples Aplicaciones					
F 15116	TRBS		VOLVO	FH 12 * FH 16	Caixa de Mudanças / Caja de Cambios / Gearbox
F 15128	TRBDR		GENERAL MOTORS	Corsa	Eixo Traseiro / Eje Trasero / Rear Axle
F 15139	BBS	References Fersa with Multiple Applications / Referências Fersa com Múltiplas Aplicações / Referencias Fersa con Múltiples Aplicaciones			
F 15140	BBS	References Fersa with Multiple Applications / Referências Fersa com Múltiplas Aplicações / Referencias Fersa con Múltiples Aplicaciones			
F 15141	BBS		VALTRA	Tratores 60 * 60 ID * 62 * 65 * 65 Cafeeiro * 68 * 68 Cafeeiro * 78 * 80 * M80 * 85 * 85ID * 86 * 86 ID * 88 * 88 ID	Embreagem / Embrague / Clutch
				Tratores 110 ID * 110ID II * 118 * 118 (4x4) * 128 * 128 (4x4)	Câmbio / Caja de Cambios / Gearbox
				Tratores 685 * 685C (4x4) * 785 * 785C (4x4) * 880 Cafeeiro * 880 (4x4) * 885 * 980 (4x4) * 985 * 985F * 1180 * 1184	Embreagem / Embrague / Clutch
				Tratores 1280 * 1284 * 1580 * 1780 * 1780 (4x4) * 1380 * 1680 * 1880 * 118 * 128 * 138 * 148 * 148 (4x4)	
References Fersa with Multiple Applications / Referências Fersa com Múltiplas Aplicações / Referencias Fersa con Múltiples Aplicaciones					
F 15151	TRBDR		NISSAN	TSURU III	Eixo Traseiro / Eje Trasero / Rear Axle
F 15156	TRBS		VOLKSWAGEN	17-210	Eixo Traseiro / Eje Trasero / Rear Axle
			VOLVO	VM 17 * VM 23 * VM 210	
			RANDON	RK 425 B	Eixo Traseiro / Eje Trasero / Rear Axle
F 15158	TRBS		MERCEDES BENZ	OH 1113	Eixo Traseiro / Eje Trasero / Rear Axle
			MERCEDES BENZ	L1313 * L1314 * L1315 * L1316 * L1317 * L1318 * L1319 * L1321	
				OF 1313 * OF 1314 * OF 1315 * OF 1316 * OF 1317 * OF 1318 51	
				LA 1313 * LA 1314 * LA 1315 * LA 1316 * LA 1317 * LA 1318 * LA 1319 * LA 1320	
				LAK 1313 * LAK 1314 * LAK 1315 * LAK 1316 * LAK 1317 * LAK 1318 * LAK 1320	
				LAS 1313 * LAS 1314 * LAS 1315 * LAS 1316 * LAS 1317 * LAS 1318 * LAS 1319 * LAS 1320	
				LB 1314 * LB 1315 * LB 1316 * LB 1317 * LB 1318 * LB 1319 * LB 1320	
				LK 1313 * LK 1314 * LK 1315 * LK 1316 * LK 1317 * LK 1318 * LK 1319 * LK 1320 * LK 1321	
				LP 1313 * LP 1314 * LP 1315 * LP 1316 * LP 1317 * LP 1318 * LP 1320	
				LPO 1313 * LPO 1314 * LPO 1315 * LPO 1316 * LPO 1317 * LPO 1318 * LPO 1320	
				LS 1314 * LS 1315 * LS 1316 * LS 1317 * LS 1318 * LS 1319	
				OF 1111 * OF 1113 * OF 1114 * OF 1115 * OF 1116 * OF 1117 * OF 1118	
				OF 1320	











Fersa®			Brand / Marca / Marca	Model / Modelo / Modelo	Application / Aplicação / Aplicaciones
F 15159	TRBS		MERCEDES BENZ	Multego IBC 1842 * IBC 2242 * OC 500 O 371 R * O 371 RS * O 371 RSD O 400 R * O 400 RS * O 400 RSD * O 400 RSE * O 400 RSL * MP 105 * MP 108 DD * MP120 * MP 180 DD O500M 1728 * O500R 1735 O 370 U O 371 U * O 371 UL * O 371 UP OH 1113 OH 1517 * OH 1518 * OH 1519 * OH 1520 * OH 1521 OH 1524 * OH 1525	
			MERCEDES BENZ	2013 (L*LA*LAK*LB*LG*LK*LS) * 2013 6X2 (L) * 2014 (L*LB*LK) * 2016 (LB*LK) * 2017 (L*LB*LK) 2213 (L*LB*LK*LS) * 2213 6X6 (LA) * 2214 * 2215 (L*LB*LK*LS) * 2216 (L*LA*LAK*LB*LG*LK*LS) * 2217 (L*LB*LK*LS) * 2219 (L*LA*LAK*LB*LG*LK*LS) * 2220 * 2222 * 2225 (L*LB*LK*LS) 2414 (6X4) * 2414 (L) * 2418 (L*LB*LK) * 2420 (L*LB*LK) * 2423 B 6X4 * 2423 K 6X4 * 2425 6X6 (LA) * 2425 (L*LB*LK) * 2428 6X4 L1214 * L1215 * L1217 39 * L1217 52 * L1218 52 L1617 59 L1618 L1621 54 * L1621 59 * L1621 60 * L1621 70 * L1622 * L1623 * L1625 L1630 * L1632 * L1633 * L1634 L2013 * L2014 * L2016 * L2017 * L2024 * L2036 * L2042 OF 1313 * OF 1314 * OF 1315 * OF 1316 * OF 1317 * OF 1318 51 L 1524 * L 1525 L 1614 * L 1615 L 1620 L 1714 * L 1715 * L 1718 * L 1720 * L 1721 * L 1722 * L 1723 * L 1724 * L 1728 L 2213 * L 2214 * L 2215 * L 2216 * L 2217 * L 2219 * L 2220 L 2222 * L 2225 * L 2314 * L 2318 * L 2325 LA 2213 6X6 * LA 2214 6X6 * LA 2215 6X6 * LA 2216 6X6 * LA 2217 6X6 * LA 2219 6X6 * LA 2220 6X6 * LA 2225 6X6 LAK1524 * LAK1525 LAK 2213 * LAK 2214 * LAK 2215 * LAK 2216 * LAK 2217 * LAK 2219 * LAK 2220 * LAK 2222 * LAK 2225 LB 1524 * LB 1525 LB 2220 * LB 2222 * LB 2225 LB 2314 * LB 2318 * LB 2325 LB 2414 * LB 2418 * LB 2420 * LB 2423 * LB 2424 * LB 2428 LG 1524 * LG 1525 LK 1524 * LK 1525 LK 1614 * LK 1615 * LK 1617 * LK 1618 * LK 1620 * LK 1621 * LK 1622 * LK 1623 * LK 1625 * LK 1630 * LK 1633 * LK 1634 LK 1714 * LK 1715 * LK 1718 * LK 1720 * LK 1721 * LK 1722 * LK 1723 * LK 1724 * LK 1728 LK 2013 6X2 * LK 2014 * LK 2016 * LK 2017 * LK 2024 * LK 2036 * LK 2042 LK 2314 * LK 2318 * LK 2325 LK 2629 * LK 2635 * LK 2638 * LK 2654 LP 1525 * LPK1525 * LPS1525 * LS 1525 LS 1524 * LP1524 * LPK1524 * LPS1524 LS 2220 * LS 2222 * LS 2225 * LS 2314 * LS 2325 LS 2629 * LS 2635 * LS 2638 * LS 2654 OF 1215 * OF 1217 OF 1320 OF 1517 * OF 1518 * OF 1519 * OF 1520 * OF 1521 * OF 1524 * OF 1525 OF 1618 * OF 1620 * OF 1621 * OF 1625 * OF 1628 * OF 1630 * OF 1635 * OF 1636 OF 1714 * OF 1718 * OF 1721 * OF 1725	Eixo Traseiro / Eje Trasero / Rear Axle













Fersa®			Brand / Marca / Marca	Model / Modelo / Modelo	Application / Aplicação / Aplicaciones
F 15159	TRBS		MERCEDES BENZ	OF 1313 * OF 1314 * OF 1315 * OF 1316 * OF 1317 * OF 1318 51	Eixo Traseiro / Eje Trasero / Rear Axle
				OF 1215 * OF 1217	
				OF 1320	
				OF 1517 * OF 1518 * OF 1519 * OF 1520 * OF 1521 * OF 1524 * OF 1525	
				OF 1618 * OF 1620 * OF 1621 * OF 1625 * OF 1628 * OF 1630 * OF 1635 * OF 1636	
				OF 1714 * OF 1718 * OF 1721 * OF 1725	
F 15165	TRBS		FNH	Tratores 4600 * 4610 * 4630 * 5600 * 5610 * 5630 * 6600 * 6610 * 6630 * 7610 * 7630 * 7810 * 7830 * 8030 * 8BR	Diferencial / Diferencial / Differential
			VALTRA	Tratores 685 * 685C (4x4) * 785 * 785C (4x4) * 880 Cafeeiro * 880 (4x4) * 885 * 980 (4x4) * 985 * 985F * 1180 * 1184	
References Fersa with Multiple Applications / Referências Fersa com Múltiplas Aplicações / Referencias Fersa con Multiples Aplicaciones					
F 15173	TRBDR		RENAULT	Trafic	Eixo Traseiro / Eje Trasero / Rear Axle
F 15175	TRBDR		RENAULT	Megane	Eixo Traseiro / Eje Trasero / Rear Axle
F 15183	TRBS		MERCEDES	1313 OF * 1314 OF * 1315 OF * 1316 OF * 1317 OF * 1318 OF * 1319 OF * 1320 OF	Eixo Traseiro / Eje Trasero / Rear Axle
				1517 OF * 1518 OF * 1520 OF	
				1618 (OF)	
				2414 (6X4) * 2414 (L) * 2418 (L*LB*LK) * 2420 (L*LB*LK) * 2423 B 6X4 * 2423 K 6X4 * 2425 6X6 (LA) * 2425 (L*LB*LK) * 2428 6X4	
References Fersa with Multiple Applications / Referências Fersa com Múltiplas Aplicações / Referencias Fersa con Multiples Aplicaciones					
F 16013	BBDRAC		FIAT	Brava	Eixo Dianteiro / Eje Delantero / Front Axle
				Doblò	
				Elba	
				Fiorino	
				Idea	
				Marea * Marea Weekend	
				Palio * Palio Weekend * Siena	
				Prêmio	
				Strada	
				Tempra	
			Tipo		
			Uno		
			RENAULT	Clio	
				Kangoo	
				Laguna	
				Mégane	
				R 21	
Scénic					
Twingo					
DAEWOO	Lanos	Eixo Dianteiro / Eje Delantero / Front Axle			
	Racer				
	GENERAL MOTORS		Aveo		
	PONTIAC		G3		
VOLKSWAGEN	Atlantic	Eixo Dianteiro / Eje Delantero / Front Axle			
	Caribe				
F 16020	BBDRAC		GENERAL MOTORS	Chevy	Eixo Dianteiro / Eje Delantero / Front Axle
				Tigra	
F 16021	BBDRAC	References Fersa with Multiple Applications / Referências Fersa com Múltiplas Aplicações / Referencias Fersa con Multiples Aplicaciones			
F 16023	BBDRAC		VOLKSWAGEN	Polo Classic	Eixo Dianteiro / Eje Delantero / Front Axle
F 16026	BBDRAC		CITROËN	AX * ZX	Eixo Dianteiro / Eje Delantero / Front Axle
				Xsara	
			FIAT	Tipo	
PEUGEOT			205	Eixo Dianteiro / Eje Delantero / Front Axle	
			306		
F 16028	BBDRAC		VOLKSWAGEN	Polo Classic	Eixo Dianteiro / Eje Delantero / Front Axle















Fersa®			Brand / Marca / Marca	Model / Modelo / Modelo	Application / Aplicação / Aplicaciones
F 16029	BBDRAC		References Fersa with Multiple Applications / Referências Fersa com Múltiplas Aplicações / Referencias Fersa con Multiples Aplicaciones		
F 16030	BBDRAC		References Fersa with Multiple Applications / Referências Fersa com Múltiplas Aplicações / Referencias Fersa con Multiples Aplicaciones		
F 16032	BBDRAC		GENERAL MOTORS	Omega * Suprema	Eixo Traseiro / Eje Trasero / Rear Axle
F 16034	BBDRAC		NISSAN	Lucino	Eixo Dianteiro / Eje Delantero / Front Axle
				Sentra	
				Tsubame	
				Tsuru III	
F 16035	BBDRAC		References Fersa with Multiple Applications / Referências Fersa com Múltiplas Aplicações / Referencias Fersa con Multiples Aplicaciones		
F 16036	BBDRAC		FORD	Courier	Eixo Dianteiro / Eje Delantero / Front Axle
				Fiesta	
				Focus	
				Ikon	
			Ka		
			VOLKSWAGEN	Crossfox	
				Gol	
				Lupo	
Pointer					
Saveiro					
Van					
F 16037	BBDRAC		GENERAL MOTORS	Optra	Eixo Dianteiro / Eje Delantero / Front Axle
F 16038	BBDRAC		AUDI	A4	Eixo Dianteiro / Eje Delantero / Front Axle
			VOLKSWAGEN	Passat	
F 16039	BBDRAC		SEAT	Cordoba	Eixo Dianteiro / Eje Delantero / Front Axle
				Ibiza	
				Inca	
				Toledo	
			VOLKSWAGEN	Cabrio	
				Caddy	
				Corrado	
				Derby	
				Golf	
				Jetta	
				Passat	
				Passat 2.8 VR8	
				Polo Classic	
				Vento	
F 16040	BBDRAC		AUDI	A3 * S3 * TT	Eixo Dianteiro / Eje Delantero / Front Axle
			SEAT	Toledo II	
			SKODA	Octavia	
			VOLKSWAGEN	Bora	
				Golf IV	
				Jetta	
				New Beetle	
F 16044	BBDRAC		References Fersa with Multiple Applications / Referências Fersa com Múltiplas Aplicações / Referencias Fersa con Multiples Aplicaciones		
F 16048	BBDRAC		References Fersa with Multiple Applications / Referências Fersa com Múltiplas Aplicações / Referencias Fersa con Multiples Aplicaciones		
F 16051	BBDRAC		References Fersa with Multiple Applications / Referências Fersa com Múltiplas Aplicações / Referencias Fersa con Multiples Aplicaciones		
F 16052	BBDRAC		HONDA	Civic	Eixo Dianteiro / Eje Delantero / Front Axle
F 16054	BBDRAC		AUDI	A4	Eixo Dianteiro / Eje Delantero / Front Axle
			VOLKSWAGEN	Passat	
F 16055	BBDRAC		FORD	Contour	Eixo Dianteiro / Eje Delantero / Front Axle
				Escape	Eixo Traseiro / Eje Trasero / Rear Axle
			MERCURY	Mariner	
F 16057	BBDRAC		DODGE	Atos	Eixo Dianteiro / Eje Delantero / Front Axle
				Attitude	
			PEUGEOT	206	
				207	











Fersa®			Brand / Marca / Marca	Model / Modelo / Modelo	Application / Aplicação / Aplicaciones
F 16057	BBDRAC		PEUGEOT	306	Eixo Dianteiro / Eje Delantero / Front Axle
				405	
				406	
				Grand Raid	
				Partner	
F 16058	BBDRAC		NISSAN	Hikari	Eixo Dianteiro / Eje Delantero / Front Axle
				Tsuru II	
F 16059	BBDRAC		CHRYSLER	Crossfire	Eixo Traseiro / Eje Trasero / Rear Axle
F 16065	BBDRAC		VOLKSWAGEN	Golf IV	Eixo Traseiro / Eje Trasero / Rear Axle
				Jetta	
				New Beetle	
F 16078	BBDRAC		TOYOTA	RAV4	Eixo Dianteiro / Eje Delantero / Front Axle
F 16081	BBDRAC		NISSAN	Altima	Eixo Dianteiro / Eje Delantero / Front Axle
				Maxima	
F 16083	BBDRAC		GENERAL MOTORS	Corsa	Eixo Dianteiro / Eje Delantero / Front Axle
				Corsa Novo * Meriva * Montana	
				Meriva	
				Tornado	
F 16088	BBDRAC		FORD	Fusion	Eixo Dianteiro / Eje Delantero / Front Axle
			LINCOLN	MKX	
			MAZDA	Mazda3	
				Mazda5	
				Mazda6	
F 16097	BBDRAC	References Fersa with Multiple Applications / Referências Fersa com Múltiplas Aplicações / Referencias Fersa con Multiples Aplicaciones			
F 16098	BBDRAC	References Fersa with Multiple Applications / Referências Fersa com Múltiplas Aplicações / Referencias Fersa con Multiples Aplicaciones			
F 16099	BBDRAC	References Fersa with Multiple Applications / Referências Fersa com Múltiplas Aplicações / Referencias Fersa con Multiples Aplicaciones			
F 16100	BBDRAC	References Fersa with Multiple Applications / Referências Fersa com Múltiplas Aplicações / Referencias Fersa con Multiples Aplicaciones			
F 16101	BBDRAC	References Fersa with Multiple Applications / Referências Fersa com Múltiplas Aplicações / Referencias Fersa con Multiples Aplicaciones			
F 16102	BBDRAC	References Fersa with Multiple Applications / Referências Fersa com Múltiplas Aplicações / Referencias Fersa con Multiples Aplicaciones			
F 16103	BBDRAC	References Fersa with Multiple Applications / Referências Fersa com Múltiplas Aplicações / Referencias Fersa con Multiples Aplicaciones			
F 16104	BBDRAC	References Fersa with Multiple Applications / Referências Fersa com Múltiplas Aplicações / Referencias Fersa con Multiples Aplicaciones			
F 16110	BBDRAC		VOLKSWAGEN	Saveiro	Eixo Dianteiro / Eje Delantero / Front Axle
F 16194	BBDRAC		CHRYSLER	PT Cruiser	Eixo Dianteiro / Eje Delantero / Front Axle
				Cougar	Eixo Traseiro / Eje Trasero / Rear Axle
			FORD	Taurus	Eixo Dianteiro / Eje Delantero / Front Axle
				Thunderbird	Eixo Traseiro / Eje Trasero / Rear Axle
				Windstar	Eixo Dianteiro / Eje Delantero / Front Axle
F 16195	BBDRAC		CHRYSLER	Dart K	Eixo Dianteiro / Eje Delantero / Front Axle
				LeBaron	
				New Yorker	
				Phantom	
				Shadow	
				Volare K	
F 16196	BBDRAC		NISSAN	Altima	Eixo Dianteiro / Eje Delantero / Front Axle
				Maxima	
F 16197	BBDRAC		DODGE	Neon	Eixo Dianteiro / Eje Delantero / Front Axle
F 16198	BBDRAC		DODGE	Neon	Eixo Dianteiro / Eje Delantero / Front Axle
F 16199	BBDRAC		NISSAN	Quest	Eixo Dianteiro / Eje Delantero / Front Axle
F 18018	BBS	References Fersa with Multiple Applications / Referências Fersa com Múltiplas Aplicações / Referencias Fersa con Multiples Aplicaciones			
F 18021	BBS		MERCEDES BENZ	MB 180	Câmbio / Caja de Cambios / Gearbox







Fersa*			Brand / Marca / Marca	Model / Modelo / Modelo	Application / Aplicação / Aplicaciones
F 18024	BBS		AUDI	A3 * S3 * TT	Câmbio / Caja de Cambios / Gearbox
			FORD	Escort	
			FORD	Fiesta	
			SEAT	Cordoba	
				Ibiza	
			VOLKSWAGEN	Inca	
				Apollo	
F 18031	BBS	References Fersa with Multiple Applications / Referências Fersa com Múltiplas Aplicações / Referencias Fersa con Multiples Aplicaciones			
F 18039	BBS	References Fersa with Multiple Applications / Referências Fersa com Múltiplas Aplicações / Referencias Fersa con Multiples Aplicaciones			
F 18040	BBS	References Fersa with Multiple Applications / Referências Fersa com Múltiplas Aplicações / Referencias Fersa con Multiples Aplicaciones			
F 18041	BBS	References Fersa with Multiple Applications / Referências Fersa com Múltiplas Aplicações / Referencias Fersa con Multiples Aplicaciones			
F 19001	CRBS		SCANIA	K 124 CA (6x4 * 6x2)	Eixo Traseiro / Eje Trasero / Rear Axle
			SCANIA	P 114 * R 124 * T 114 CB 6x4 * 4x2 * T 124	
P 94 CB (4x2 * 6x2 * 6X4)					
94I * 94H * 94U * P94 CB (6x4*4x2) * 114L * P114 * T114 CB (6x4*4x2) * 124E * R124 * K124 CA (6x4*6x2) * T124 * P124 CA * CB (6x4*4x2) * 164 * P230 * P270 * P310 * P340 * P420 * R380 * R420 * R480					
F 19002	CRBS	References Fersa with Multiple Applications / Referências Fersa com Múltiplas Aplicações / Referencias Fersa con Multiples Aplicaciones			
F 19008	CRBS		MERCEDES	1924 (LS) * 1924 A (LS) * 1929 (L*LK*LS) * 1930 (LS) * 1932 (LS) * 1933 (LS) * 1934 (LS) * 1935 (L*LS) * 1938 * 1938 S * 1938 (L*LS) * 1941 (L*LS) * 1944 S * 1945 (L*LS)	Câmbio / Caja de Cambios / Gearbox
				Axor 2625 * 2628 * 2629 (LK*LS) * 2631 (B*K*L) * 2632 * 2635 (B*K*L) * 2635 (L*LK*LS) * 2635 * 2638 (L*LK*LS) * Axor 2640 * 2641 * 2643 * Axor 2644 * Actos 2646 * 2648 * 2650 * 2651 * 2653 * 2654 (L*LK*LS) * 2657 * 2658 * 2644 * Atego 2628 (B*K) * 2625 * Axor 2826 * Axor 2828 * Axor 2831	
References Fersa with Multiple Applications / Referências Fersa com Múltiplas Aplicações / Referencias Fersa con Multiples Aplicaciones					
F 19009	CRBS	References Fersa with Multiple Applications / Referências Fersa com Múltiplas Aplicações / Referencias Fersa con Multiples Aplicaciones			
F 19010	CRBS		IVECO	Eurotrakker * Power Star 450 E37T * Eurotech E37	Caixa de Mudanças / Caja de Cambios / Gearbox
			SCANIA	Diversos	
			VOLVO	FH 12 * FH 16	
				N * NL 10 BR * N * NL 12 BR * N 10BR Mark II * NL 10BR 6x2	
		NH 12 * FM 12			
	RANDON	RK 425 B			
F 19011	CRBS		MERCEDES BENZ	1113 (LPO*OH) * 1114 LPO * 1115 L (OH) * 1118 LPO	Caixa de Mudanças / Caja de Cambios / Gearbox
				1313 OH * 1314 OH * 1315 OH * 1316 (OH*OHL) * 1316 G (OH*OHL) * 1317 OH * 1318 OH * 1319 OH * 1320 (OH*OHL)	
				1418 OH * 1419 OH * 1420 (OH*OHL) * 1421 OHL	
				1517 OH * 1518 OH * 1519 OH * 1520 OH * 1521 OH	
				1621 L (OH) * 1623 LG (OH) * 1625 (OH) * 1625 L (OH) * 1628 L (OH) * 1630L (OH) * 1635 (OH) * 1636 L (OH)	
				1721 L (OH)	
				326 O	
				362 O	
				364 O	
				370 RS*RSD*RST* ST*U*UP (O) * 371 RS*RSD*RST* ST*U*UP (O)	
				O 371 U * O 371 UL * O 371 UP	
		MERCEDES BENZ	1113 (L*LA*LAK*LAS*LK*LP*LS*LP) * 1114 * 1114 (L*LK*LP) * 1116 (L*LA*LAK*LAS*LB* LK*LS) * 1118 (L*LK*LP)		
			1113 OF * 1115 OF		
			1214 C * 1214 K * 1214 (L*LK*LS) * 1215 * 1215 C * 1215 (L*LA*LK) * 1218 * 1218 R (L)		
			1215 OF * 1217 OF		
			1313 (L*LA*LAK*LB*LK*LS) * 1314 (L*LA*LAK*LB*LK*LS) * 1316 (L*LA*LAK*LAS*LB*LK*LS) * 1317 (L*LA*LAK*LK*LS) * 1319 (L)		
			1313 OF * 1314 OF * 1315 OF * 1316 OF * 1317 OF * 1318 OF * 1319 OF * 1320 OF		
			1414 * 1414 (K*L*LA*LAK*LK) * 1418 * 1418 (E*K*R) * 1418 (L*LA*LAK*LK*R(LK)) * 1419 (L*LK*LS) * 1420 (L*LK*LS)		
			1417 OF * 1419 OF * 1421 OF		
			1421 OMC		





Fersa®			Brand / Marca / Marca	Model / Modelo / Modelo	Application / Aplicação / Aplicaciones
F 19011	CRBS		MERCEDES BENZ	1513 (L*LA*LAK*LB*LG*LK*LS) * 1514 (L*LK*LS) * 1516 (L*LA*LAK*LB*LG*LK*LS) * 1517 (L*LK) * 1518 (L*LK*LS) * 1519 (L*LAK*LB*LG*LK*LS) * 1520 (L*LK*LP*LPK*LPS*LS) * 1521 L * 1524 e 1525 (L*LK*LS)	Caixa de Mudanças / Caja de Cambios / Gearbox
				1517 OF * 1518 OF * 1520 OF	
				1614 * 1615 (L*LK*LS) * 1615 * 1618 M * 1618 (L*LK*LS) * 1619 (L)	
				1618 OF	
				1620(L*LK*LS) * 1620 6X2 51 (L) * 1621 (L*LK*LS) * 1622(L*LK*LS) * 1623 (L*LS) * 1625(L*LK*LS) * 1630 (L*LK*LS) * 1632 (L*LS) * 1633(L*LK*LS) * 1634 (L*LS) * 1635 L	
				1620 OF * 1621 OF	
				1714 OF * 1721 OF * 1722 OF	
				1714 * 1714 (L*K*LK) * 1715 * 1718 * 1718 (A * AK) * K * 1720 L * 1721 * 1721 S * 1721 (L*LK) * 1722 S * 1723 * 1723 S * 1725 L	
				2013 (L*LA*LAK*LB*LG*LK*LS) * 2013 6X2 (L) * 2014 (L*LB*LK) * 2016 (LB*LK) * 2017 (L*LB*LK)	
		2213 (L*LB*LK*LS) * 2213 6X6 (LA) * 2214 * 2215 (L*LB*LK*LS) * 2216 (L*LA*LAK*LB*LG*LK*LS) * 2217 (L*LB*LK*LS) * 2219 (L*LA*LAK*LB*LG*LK*LS) * 2220 * 2222 * 2225 (L*LB*LK*LS)			
		2314 (L*LB*LK*LS) * 2318 (L*LB*LK*LS) * 2325 (L*LB*LK*LS)			
		2414 (6X4) * 2414 (L) * 2418 (L*LB*LK) * 2420 (L*LB*LK) * 2423 B 6X4 * 2423 K 6X4 * 2425 6X6 (LA) * 2425 (L*LB*LK) * 2428 6X4	Eixo Traseiro / Eje Trasero / Rear Axle		
			MERCEDES BENZ	1113 OF * 1115 OF	Caixa de Mudanças / Caja de Cambios / Gearbox
				1215 OF * 1217 OF	
				1313 OF * 1314 OF * 1315 OF * 1316 OF * 1317 OF * 1318 OF * 1319 OF * 1320 OF	
				1417 OF * 1419 OF * 1421 OF	
				1421 OMC	
				1517 OF * 1518 OF * 1520 OF	
1618 OF					
1620 OF * 1621 OF					
1714 OF * 1721 OF * 1722 OF					
F 19012	CRBS	References Fersa with Multiple Applications / Referências Fersa com Múltiplas Aplicações / Referencias Fersa con Multiples Aplicaciones			
F 19013	CRBS		MERCEDES BENZ	Multitego IBC 1842 * IBC 2242 * OC 500 O 371 R * O 371 RS * O 371 RSD O 400 R * O 400 RS * O 400 RSD * O 400 RSE * O 400 RSL * MP 105 * MP 108 DD * MP120 * MP 180 DD	Eixo Traseiro / Eje Trasero / Rear Axle
F 19015	CRBS		MERCEDES BENZ	OMC 1423 51 Torino	Eixo Traseiro / Eje Trasero / Rear Axle
				OMC 1425 51 Allegro	
			MERCEDES BENZ	OMC 1421 51 OMC 1425 51 Allegro	
F 19016	CRBS	References Fersa with Multiple Applications / Referências Fersa com Múltiplas Aplicações / Referencias Fersa con Multiples Aplicaciones			
F 19019	CRBS		MERCEDES BENZ	1517 OH * 1518 OH * 1519 OH * 1520 OH * 1521 OH	Caixa de Mudanças / Caja de Cambios / Gearbox
				1721 L (OH)	
				1513 (L*LA*LAK*LB*LG*LK*LS) * 1514 (L*LK*LS) * 1516 (L*LA*LAK*LB*LG*LK*LS) * 1517 (L*LK) * 1518 (L*LK*LS) * 1519 (L*LAK*LB*LG*LK*LS) * 1520 (L*LK*LP*LPK*LPS*LS) * 1521 L * 1524 e 1525 (L*LK*LS)	
		1517 OF * 1518 OF * 1520 OF			
		1614 * 1615 (L*LK*LS) * 1615 * 1618 M * 1618 (L*LK*LS) * 1619 (L)			
		1618 OF			
		1714 OF * 1721 OF * 1722 OF			
		1714 * 1714 (L*K*LK) * 1715 * 1718 * 1718 (A * AK) * K * 1720 L * 1721 * 1721 S * 1721 (L*LK) * 1722 S * 1723 * 1723 S * 1725 L			
		1517 OF * 1518 OF * 1520 OF			
			MERCEDES BENZ	1618 OF	
				1714 OF * 1721 OF * 1722 OF	
		F 19020	CRBS	References Fersa with Multiple Applications / Referências Fersa com Múltiplas Aplicações / Referencias Fersa con Multiples Aplicaciones	
F 19029	CRBS	References Fersa with Multiple Applications / Referências Fersa com Múltiplas Aplicações / Referencias Fersa con Multiples Aplicaciones			
F 19033	CRBS		MOTOR COACH	F12 P14	Eixo Traseiro / Eje Trasero / Rear Axle
			VOLVO	Busscar dos y tres ejes	





Fersa®			Brand / Marca / Marca	Model / Modelo / Modelo	Application / Aplicação / Aplicaciones		
F 19034	CRBS		MASA	502 UX	Eixo Traseiro / Eje Trasero / Rear Axle		
				Jaguar * Condor * Géminis * Halcón * Strada * Premier 2030F			
				S 5000 * S 5002 * S 2030			
				S500T * S500U * S501U			
			DINA	751 Multi Torque			
				861 K			
			FREIGHTLINER	FLD 120			
				FS 65			
			INTERNATIONAL	4900 DT 466E			
			KENWORTH	T2000			
T 600 Aerocab, B, Modular							
T800 * Aerocab * Modular * SHW (Short hood wide) * HB * BSH Aerocab * SH 6X4 * 8X4							
W900 * W924							
F 19039	CRBS		IVECO	Eurotrakker * Power Star 450 E37T * Eurotech E37	Caixa de Mudanças / Caja de Cambios / Gearbox		
				SCANIA		Diversos	
			VOLVO	FH 12 * FH 16			
				N * NL 10 BR * N * NL 12 BR * N 10BR Mark II * NL 10BR 6x2 NH 12 * FM 12			
			RANDON	RK 425 B			
		F 19042	CRBS	References Fersa with Multiple Applications / Referências Fersa com Múltiplas Aplicações / Referencias Fersa con Multiples Aplicaciones			
F 19043	CRBS		MERCEDES BENZ	O 371 U * O 371 UL * O 371 UP	Eixo Traseiro / Eje Trasero / Rear Axle		
F 19044	CRBS		MERCEDES BENZ	O 371 U * O 371 UL * O 371 UP	Caixa de Mudanças / Caja de Cambios / Gearbox		
F 19046	CRBS		MERCEDES BENZ	1418 OH * 1419 OH * 1420 (OH*OHL) * 1421 OHL	Caixa de Mudanças / Caja de Cambios / Gearbox		
				1621 L (OH) * 1623 LG (OH) * 1625 (OH) * 1625 L (OH) * 1628 L (OH) * 1630L (OH) * 1635 (OH) * 1636 L (OH)			
				1721 L (OH)			
				1214 C * 1214 K * 1214 (L*LK*LS) * 1215 * 1215 C * 1215 (L*LA*LK) * 1218 * 1218 R (L)			
				1215 OF * 1217 OF			
				1414 * 1414 (K*L*LA*LAK*LK) * 1418 * 1418 (E*K*R) * 1418 (L*LA*LAK*LK*R(LK)) * 1419 (L*LK*LS) * 1420 (L*LK*LS)			
				1417 OF * 1419 OF * 1421 OF			
				1421 OMC			
				1614 * 1615 (L*LK*LS) * 1615 * 1618 M * 1618 (L*LK*LS) * 1619 (L)			
				1618 OF			
		1620(L*LK*LS) * 1620 6X2 51 (L) * 1621 (L*LK*LS) * 1622(L*LK*LS) * 1623 (L*LS) * 1625(L*LK*LS) * 1630 (L*LK*LS) * 1632 (L*LS) * 1633(L*LK*LS) * 1634 (L*LS) * 1635 L					
		1620 OF * 1621 OF					
		1714 OF * 1721 OF * 1722 OF					
		1714 * 1714 (L*K*LK) * 1715 * 1718 * 1718 (A * AK) * K * 1720 L * 1721 * 1721 S * 1721 (L*LK) * 1722 S * 1723 * 1723 S * 1725 L					
		2314 (L*LB*LK*LS) * 2318 (L*LB*LK*LS) * 2325 (L*LB*LK*LS)					
			MERCEDES BENZ	1215 OF * 1217 OF			
				1417 OF * 1419 OF * 1421 OF			
				1421 OMC			
				1618 OF			
				1620 OF * 1621 OF			
1714 OF * 1721 OF * 1722 OF							
F 19047	CRBS				MERCEDES BENZ	1418 OH * 1419 OH * 1420 (OH*OHL) * 1421 OHL	Caixa de Mudanças / Caja de Cambios / Gearbox
						1621 L (OH) * 1623 LG (OH) * 1625 (OH) * 1625 L (OH) * 1628 L (OH) * 1630L (OH) * 1635 (OH) * 1636 L (OH)	
					MERCEDES BENZ	1414 * 1414 (K*L*LA*LAK*LK) * 1418 * 1418 (E*K*R) * 1418 (L*LA*LAK*LK*R(LK)) * 1419 (L*LK*LS) * 1420 (L*LK*LS)	
						1417 OF * 1419 OF * 1421 OF	
1421 OMC							
1614 * 1615 (L*LK*LS) * 1615 * 1618 M * 1618 (L*LK*LS) * 1619 (L)							
1618 OF							















Fersa®			Brand / Marca / Marca	Model / Modelo / Modelo	Application / Aplicação / Aplicaciones
F 19047	CRBS		MERCEDES BENZ	1620(L*LK*LS) * 1620 6X2 51 (L) * 1621 (L*LK*LS) * 1622(L*LK*LS) * 1623 (L*LS) * 1625(L*LK*LS) * 1630 (L*LK*LS) * 1632 (L*LS) * 1633(L*LK*LS) * 1634 (L*LS) * 1635 L	Caixa de Mudanças / Caja de Cambios / Gearbox
				1620 OF * 1621 OF	
				1714 OF * 1721 OF * 1722 OF	
				1714 * 1714 (L*K*LK) * 1715 * 1718 * 1718 (A * AK) * K * 1720 L * 1721 * 1721 S * 1721 (L*LK) * 1722 S * 1723 * 1723 S * 1725 L	
				2314 (L*LB*LK*LS) * 2318 (L*LB*LK*LS) * 2325 (L*LB*LK*LS)	
			MERCEDES BENZ	1417 OF * 1419 OF * 1421 OF	
				1421 OMC	
				1618 OF	
				1620 OF * 1621 OF	
				1714 OF * 1721 OF * 1722 OF	
F 19048	CRBS	References Fersa with Multiple Applications / Referências Fersa com Múltiplas Aplicações / Referencias Fersa con Multiples Aplicaciones			
F 19075	CRBS	References Fersa with Multiple Applications / Referências Fersa com Múltiplas Aplicações / Referencias Fersa con Multiples Aplicaciones			
F 19076	CRBS		SCANIA	K 124 CA (6x4 * 6x2) P 114 * R 124 * T 114 CB 6x4 * 4x2 * T 124	Eixo Traseiro / Eje Trasero / Rear Axle
			SCANIA	P 94 CB (4x2 * 6x2 * 6X4) 941 * 94H * 94U * P94 CB (6x4*4x2) * 114L * P114 * T114 CB (6x4*4x2) * 124E * R124 * K124 CA (6x4*6x2) * T124 * P124 CA * CB (6x4*4x2) * 164 * P230 * P270 * P310 * P340 * P420 * R380 * R420 * R480	
F 200001 A	KWT		VOLVO	FH 12 * FH 16	Eixo Traseiro / Eje Trasero / Rear Axle
				NH 12 * FM 12	Eixo Dianteiro / Eje Delantero / Front Axle
F 200002 A	KWT		VOLVO	FH 12 * FH 16	Eixo Dianteiro / Eje Delantero / Front Axle
				NH 12 * FM 12	Eixo Traseiro / Eje Trasero / Rear Axle
F 200003	KWT		VOLVO	NH 12 * FM 12	Eixo Dianteiro / Eje Delantero / Front Axle
F 200004	KWT		MAN	18-260 * 310 * 360 * 410 * 460	Eixo Traseiro / Eje Trasero / Rear Axle
F 300006	CWT		IVECO	Daily I 59-12 e Turbo Daily (...12/99)	Eixo Dianteiro / Eje Delantero / Front Axle
H 715334 / H 715311	TRB		DINA	751 Multi Torque	Eixo Traseiro / Eje Trasero / Rear Axle
				861 K	
				Viaggio	
			MASA	502 UX	
				Jaguar * Condor * Géminis * Halcón * Strada * Premier 2030F S 5000 * S 5002 * S 2030	
			FAMSA	DC 10264 Autocar	
			FREIGHTLINER	FC 70	
				FL 112QR 6X4	
				FLD 120	
			INTERNATIONAL	FS 65	
KENWORTH	4900 DT 466E				
	T2000				
	T 600 Aerocab, B, Modular T800 * Aerocab * Modular * SHW (Short hood wide) * HB * BSH Aerocab * SH 6X4 * 8X4 W900 * W924				
H 715343 / H 715311	TRB		DINA	300 Serie	Eixo Traseiro / Eje Trasero / Rear Axle
				F11 * F12 * F14	
				Marco Polo	
			MASA	Viaggio	
				502 UX	
		DINA	Jaguar * Condor * Géminis * Halcón * Strada * Premier 2030F S 5000 * S 5002 * S 2030		
			FORD	751 Multi Torque	
				861 K	
LT-800					











Fersa®			Brand / Marca / Marca	Model / Modelo / Modelo	Application / Aplicação / Aplicaciones
H 715343 / H 715311	TRB		FREIGHTLINER	Argosy	Caixa de Mudanças / Caja de Cambios / Gearbox
				C-120 * Columbia * Coronado * CST 120	
				FLD 120	
			FS 65		
			INTERNATIONAL	4900 DT 466E	
			KENWORTH	T2000	
T 600 Aerocab, B, Modular					
T800 * Aerocab * Modular * SHW (Short hood wide) * HB * BSH Aerocab * SH 6X4 * 8X4					
H 715345 / H 715311	TRB		MERCEDES BENZ	1517 OH * 1518 OH * 1519 OH * 1520 OH * 1521 OH	Eixo Traseiro / Eje Trasero / Rear Axle
				OH 1517 * OH 1518 * OH 1519 * OH 1520 * OH 1521	
				OH 1524 * OH 1525	
		FAMSA	DC 10264 Autocar		
			DC 9964 Autocar		
		MERCEDES BENZ	1513 (L*LA*LAK*LB*LG*LK*LS) * 1514 (L*LK*LS) *		
			1516 (L*LA*LAK*LB*LG*LK*LS) * 1517 (L*LK) *		
			1518 (L*LK*LS) * 1519 (L*LAK*LB*LG*LK*LS) *		
			1520 (L*LK*LP*LPK*LPS*LS) * 1521 L * 1524 e 1525 (L*LK*LS)		
			1517 OF * 1518 OF * 1520 OF		
			LP 1520 * LPK1520 * LPS1520		
			OF 1513 * OF 1514		
		OF 1517 * OF 1518 * OF 1519 * OF 1520 * OF 1521 *			
		OF 1524 * OF 1525			
		MERCEDES BENZ	1517 OF * 1518 OF * 1520 OF		
OF 1513 * OF 1514					
OF 1517 * OF 1518 * OF 1519 * OF 1520 * OF 1521 *					
OF 1524 * OF 1525					
H 913842 / H 913810	TRB		VOLVO	7550	Eixo Traseiro / Eje Trasero / Rear Axle
				B 10M BR	
				B 10R * B 12B * B 12R * B 58 * B 58BR * B 7R * B9	
				B 58	
				B 58 BR (...Chassi 304120)	
		SCANIA	94I * 94H * 94U * P94 CB (6x4*4x2) * 114L * P114 * T114 CB (6x4*4x2) * 124E * R124 * K124 CA (6x4*6x2) * T124 * P124 CA *		
			CB (6x4*4x2) * 164 * P230 * P270 * P310 * P340 * P420 * R380 * R420 * R480		
			R 112 (81...)		
			T 142 E (6X4)		
			FH 12 * FH 16		
VOLVO	N * NL 10 BR * N * NL 12 BR * N 10BR Mark II * NL 10BR 6x2				
	NH 12 * FM 12				
H 914841 / H 914811	TRB		KENWORTH	T300 4X2 * 6X4	Eixo Traseiro / Eje Trasero / Rear Axle
			MERCEDES BENZ	OMC 1425 51 Allegro	
HM 212044 / HM 212011	TRB	  	MASA	S 5000 * S 5002 * S 2030	Eixo Dianteiro / Eje Delantero / Front Axle
			FAMSA	DC 10264 Autocar	
			DINA	555 OF	
HM 212047 / HM 212011	TRB		DINA	300 Serie	Eixo Dianteiro / Eje Delantero / Front Axle
				Citus 11000 * 9500	
				D-Avante Plus * D-Dorado	
			Paradiso * Quadro		
			MASA	502 UX	
				Jaguar * Condor * Géminis * Halcón * Strada * Premier 2030F	
		S500T * S500U * S501U			
		Ursus			
		VOLVO	C 10 * C 11		
			C 11R * C 12R		
			U 12 * U 18 Articulado		
		DINA	552 Q		
			604 G1 * 604 G3 * 604 L1 * 604 L5 * 631 K1 * 631 K3 * 661 C1 * 661 G1 * 661 G2 * 661 G3		
702 * 707					

















Fersa®			Brand / Marca / Marca	Model / Modelo / Modelo	Application / Aplicação / Aplicaciones						
HM 212047 / HM 212011	TRB		DINA	751 Multi Torque 861 K 9400	Eixo Dianteiro / Eje Delantero / Front Axle						
			FAMSA	L1100, L1200, L1300, L1400, L1500, L1600, L2121							
			FORD	Cargo 1313 * 1314 * 1317 * 1317E Cargo 1422 * 1514 * 1517 * 1517E * 1615 * 1615T * 1617 * 1618 * 1618T * 1619 * 1621 * 1622 * 1717E * 1722 * 1722E * 2216 * 2217 * 2218 * 2218T * 2319 * 2322 * 2324 * 2422 * 2422E * 2425 * 2428E * 2630 * 3224 * 3530 * 4030 LM-700							
			FREIGHTLINER	Argosy FC 70 FC 80 FL 70 FL 80 * FL 80 QR 4X2 FS 65							
			INTERNATIONAL	9200 * 9200i * 9400 * 9400i * Day Cab * Day Cab DDC							
			KENWORTH	T2000 T450, T450 B, T450 W T800 * Aerocab * Modular * SHW (Short hood wide) * HB * BSH Aerocab * SH 6X4 * 8X4 W900 * W924							
			STERLING	AT 9500 L7500 LT7500 LT9500 M8500 Acterra ST9500 Silver Star							
			VOLVO	NE 64 6X4 * NR 64 T							
				DINA		651 * 653 * 654 * 661 * 741	Eixo Traseiro / Eje Trasero / Rear Axle				
				VALTRA - VALMET		Tratores 60 * 60 ID * 62 * 65 * 65 Cafeeiro * 68 * 68 Cafeeiro * 78 * 80 * M80 * 85 * 85ID * 86 * 86 ID * 88 * 88 ID					
			HM 212049 / HM 212011	TRB			DINA	434 17570 Shuttle Bus 500 Serie Citus 11000 * 9500 D-Avante Plus * D-Dorado DPC311774 * DPT231770 * DPC311970 * DPT311770 * DPT351970 * DPT352171 * DPT352172 * DPX281770 DPX311970 F11 * F12 * F14 Marco Polo Paradiso * Quadro Viaggio	Eixo Traseiro / Eje Trasero / Rear Axle		
							FORD	B-800			
							INTERNATIONAL	3000 RE 4700 FBC * 4700 FE (4X2) * 4700 SCD * 4700 SCD (444 * 466)			
							MASA	502 UX Jaguar * Condor * Géminis * Halcón * Strada * Premier 2030F S 5000 * S 5002 * S 2030 Ursus		Eixo Dianteiro / Eje Delantero / Front Axle	
							MERCEDES BENZ	OH 1417 * OH 1418 OMC 1628 58 Andare			
							MOTOR COACH	F11 * F11A F12 F14 P11 * P12 P14			
							VOLKSWAGEN	17-180 * 17-210 * 17-210 OD * 17-210 EOD * 17-220 * 17-220 Tractor * 17-240 OT * 17-250 Constellation * 17-250 OE * 17-260 EOT * 17-300 * 17-310 TITAN * 17-230 EOD 17-210			
							22-140 * 22-210 * 23-210 * 23-220 * 23-250 E * 23-310 TITAN				















Fersa®			Brand / Marca / Marca	Model / Modelo / Modelo	Application / Aplicação / Aplicaciones
HM 212049 / HM 212011	TRB		VOLVO	Busscar dos y tres ejes C 10 * C 11 C 11R * C 12R U 12 * U 18 Articulado	
			CHRYSLER	D-600 * PD-600 Ram 6500	
			DINA	300 HTQ Serie	
				500 HTQ Serie	
				551	
				553 19072 * 555 19070 * 661 25070 * 743 00300	
				604 G1 * 604 G3 * 604 L1 * 604 L5 * 631 K1 * 631 K3 * 661 C1 * 661 G1 * 661 G2 * 661 G3	
				650 19570 Cab Over	
				702 * 707	
				751 Multi Torque	
				776	
				861 K	
			DCE 522570 * DCP 311970 * DCP 311 771 * DCP 351972		
			FORD	Cargo 1215 Cargo 1415 * 1416 F-700	
			FREIGHTLINER	C-120 * Columbia * Coronado * CST 120	
		FC 70			
		FC 80			
		FL 106			
		FL 112 6X4			
		FL 112QR 6X4			
		FL 70			
		FL 80 * FL 80 QR 4X2			
		FLD 120			
		FS 65			
		INTERNATIONAL	L-112		
			7400		
			4200 VT 365 * 4300 DT 466 / 195 HP		
			4400-215HP 4X2 * 4400-250HP * 4400-285HP * 4400-300HP		
			4900 DT 466E		
		KENWORTH	4900-210HP * 4900-215HP * 4900-250HP * 4900-300HP		
			9200 * 9200i * 9400 * 9400i * Day Cab * Day Cab DDC		
			T2000		
		MACK	T300 4X2 * 6X4		
			T450, T450 B, T450 W		
		MERCEDES BENZ	T800 * Aerocab * Modular * SHW (Short hood wide) * HB * BSH Aerocab * SH 6X4 * 8X4		
			CH Day Cab * CH Premium * CH Select * CH Elite * CX Vision		
			RD688S * RD690		
			L1113 * L1114 * L1116 * L1117 * L1118		
			L1214 * L1215 * L1217 39 * L1217 52 * L1218 52		
			L1313 * L1314 * L1315 * L1316 * L1317 * L1318 * L1319 * L1321		
			L1417 52		
			L1418 39 * L1418 52 * L1418 60 * L1419 59 * L1420. L1422		
			L1518 52		
			L1617 59		
			L1619 52		
			L1621 52		
			L2121 54		
			L2221		
		LK1417 34			
		LK1418 39 * LK1418 52			
		MBO 1217			









Fersa®			Brand / Marca / Marca	Model / Modelo / Modelo	Application / Aplicação / Aplicaciones
HM 212049 / HM 212011	TRB		MERCEDES BENZ	MBO 1219 52 Boxer	Eixo Dianteiro / Eje Delantero / Front Axle
				MBO 1417	
				MBO 1418 60	
				MBO 1419 60 Boxer	
				MBO 1621	
				OF 1313 * OF 1314 * OF 1315 * OF 1316 * OF 1317 *	
				OF 1318 51	
				OMC 1418 51 * OMC 1418 60	
				OMC 1419 51	
				OMC 1421 51	
				OMC 1425 51 Allegro	
				LO 1417 59	
				OF 1416 * OF 1417 * OF 1418 * OF 1419 * OF 1420 * OF 1421	
		STERLING	AT 9500		
			L7500		
			LT7500		
			LT9500		
			M8500 Acterra		
			ST9500 Silver Star		
		SUDISA	EA9EM	Eixo / Eje / Axle	
			EA9TM		
		VOLKSWAGEN	14-140 * 14-150 * 14-170 BT * 14-180 * 14-200 * 14-210 *		
			14-220		
			15-170 * 15-170E * 15-180 * 15-180E * 15-180 OD *		
			15-190 (77...) * 15-190 (77...)EOD		
			16-170 * 16-180 * 16-200 * 16-210 * 16-220 CO * 16300		
			18-310 TITAN * 18-310 OT		
			19-320 TITAN Tractor Constellation		
			24-220 * 24-250 * 24-250 Constellation * 24-250E * 26-220 *		
		26-260E * 26-300			
		31-260E * 35-300 * 40-300			
		VOLVO		Autocar / VHD 64B 6X4	
				Autohauler 6X4	
				NE 64 6X4 * NR 64 T	
				VNL 64T * 420 6X4 * 430 * 610 6X4 * 630 * 660 * 670 * 673 *	
		DAY * DAY CAB			
		DINA		311 * 312 * 314 * 362 * 315G * 316G * 317G6 * 318G * 319G *	Eixo Dianteiro / Eje Delantero / Front Axle
				321C * 323G	
			541 * 542		
			651 * 653 * 654 * 661 * 741		
		654 21071			
MERCEDES BENZ	MBO 1217				
	MBO 1219 52 Boxer				
	MBO 1417				
	MBO 1418 60				
	MBO 1419 60 Boxer				
	MBO 1621				
	OF 1313 * OF 1314 * OF 1315 * OF 1316 * OF 1317 *				
	OF 1318 51				
	OMC 1418 51 * OMC 1418 60				
	OMC 1419 51				
	OMC 1421 51				
	OMC 1425 51 Allegro				
	LO 1417 59				
	OF 1416 * OF 1417 * OF 1418 * OF 1419 * OF 1420 * OF 1421				
HM 218248 / HM 218210	TRB		SCANIA	K 124 CA 4x2 NB 340K	Eixo Traseiro / Eje Trasero / Rear Axle
				K 124 CA (6x4 * 6x2)	
				T 113 H (6X4) Paradiso	
			SCANIA	112 (F*K*S)	
				P 114 * R 124 * T 114 CB 6x4 * 4x2 * T 124	
P 94 CB (4x2 * 6x2 * 6X4)					











Fersa®			Brand / Marca / Marca	Model / Modelo / Modelo	Application / Aplicação / Aplicaciones	
HM 218248 / HM 218210	TRB		SCANIA	P 94 DB 4X2 NA 220 * P 94 DB 6X2 NA260	Eixo Traseiro / Eje Trasero / Rear Axle	
				94I * 94H * 94U * P94 CB (6x4*4x2) * 114L * P114 * T114 CB (6x4*4x2) * 124E * R124 * K124 CA (6x4*6x2) * T124 * P124 CA * CB (6x4*4x2) * 164 * P230 * P270 * P310 * P340 * P420 * R380 * R420 * R480		
				R 112 (81...)		
				R 124 GA 4X2 NA400		
				T 124 GA 6X4 * T 124 LA 6X4 NA400		
				Truck		
		SUDISA	EA9EM	Eixo / Eje / Axle		
			EA9TM			
		VOLVO	FH 12 * FH 16	Eixo Traseiro / Eje Trasero / Rear Axle		
			N * NL 10 BR * N * NL 12 BR * N 10BR Mark II * NL 10BR 6x2			
		CBT		JOHN DEERE	Tratores 8060 (4x2) * 8060 (4x4) * 8240 * 8240A * 8260 * 8440 * 8450	Câmbio / Caja de Cambios / Gearbox
					VALTRA - VALMET	Empilhadeira - 7000
Tratores 110 ID * 110ID II * 118 * 118 (4x4) * 128 * 128 (4x4)	Eixo Traseiro / Eje Trasero / Rear Axle					
Tratores 1280 * 1284 * 1580 * 1780 * 1780 (4x4) * 1380 * 1680 * 1880 * 118 * 128 * 138 * 148 * 148 (4x4)	Câmbio / Caja de Cambios / Gearbox					
Tratores 685 * 685C (4x4) * 785 * 785C (4x4) * 880 Cafeeiro * 880 (4x4) * 885 * 980 (4x4) * 985 * 985F * 1180 * 1184						
Tratores 870 CN * CK						Eixo Traseiro / Eje Trasero / Rear Axle
HM 220149 / HM 220110	TRB		VOLVO	N * NL 10 BR * N * NL 12 BR * N 10BR Mark II * NL 10BR 6x2	Eixo Traseiro / Eje Trasero / Rear Axle	
HM 516449 / HM 516410	TRB		FAMSA	DC 9964 Autocar	Eixo Traseiro / Eje Trasero / Rear Axle	
HM 518445 / HM 518410	TRB		SUDISA	EA12EF	Eixo / Eje / Axle	
HM 803145 / HM 803110	TRB		FORD	F 100 (61...80 Diesel) * F 600 (56...77 Gas.) * F 700 (77...80) * F 750 (72...77) * 750 * 2000 * 4000	Eixo Traseiro / Eje Trasero / Rear Axle	
HM 803146 / HM 803110	TRB			F 11000 * F 12000		
				F 7000 * FT 7000 e FT 8000 (77...80); F 8000 e F 8500 (77...79) * FT 8500		
HM 803149 / HM 803110	TRB		FORD	F 2000 (80...) F 4000 (75...)	Diferencial / Diferencial / Differential	
			MBB	Sprinter		
HM 803149 / HM 803110	TRB		AGRALE	TX 1600 * TX 1200	Eixo Traseiro / Eje Trasero / Rear Axle	
				FORD	F-350 * P-350	Eixo Traseiro / Eje Trasero / Rear Axle
HM 804843 / HM 804810	TRB		FORD	F 13000 * F 14000 * F 16000	Eixo Traseiro / Eje Trasero / Rear Axle	
F 19000 (77...) * F 21000 * F 22000						
HM 804846 / HM 804810	TRB		VOLVO	C 10 * C 11	Eixo Traseiro / Eje Trasero / Rear Axle	
			DINA	654 21071		
			FORD	Cargo 1313 * 1314 * 1317 * 1317E		
				Cargo 1422 * 1514 * 1517 * 1517E * 1615 * 1615T * 1617 * 1618 * 1618T * 1619 * 1621 * 1622 * 1717E * 1722 * 1722E * 2216 * 2217 * 2218 * 2218T * 2319 * 2322 * 2324 * 2422 * 2422E * 2425 * 2428E * 2630 * 3224 * 3530 * 4030		
			FREIGHTLINER	FL 60 FL 70		
			KENWORTH	T450, T450 B, T450 W		
HM 807040 / HM 807010	TRB		FAMSA	DC 9964 Autocar	Eixo Traseiro / Eje Trasero / Rear Axle	
			FIAT	70 (77...) * 80		
			FORD	F 100 (61...80 Diesel) * F 600 (56...77 Gas.) * F 700 (77...80) * F 750 (72...77) * 750 * 2000 * 4000		
				F 11000 * F 12000		
				F 13000 * F 14000 * F 16000		
F 19000 (77...) * F 21000 * F 22000						









Fersa®			Brand / Marca / Marca	Model / Modelo / Modelo	Application / Aplicação / Aplicaciones
HM 807040 / HM 807010	TRB		FORD	F-350 * P-350 F-600 * B-600 F-700	Eixo Traseiro / Eje Trasero / Rear Axle
			GENERAL MOTORS	A-C-D 60* 70* 80* 90* 99 Turbo e 3500 Heavy Duty	
			VOLKSWAGEN	D 1400 TD * Volksbus E 13 * E 21	
HM 807046 / HM 807010	TRB		MERCEDES BENZ	1517 OH * 1518 OH * 1519 OH * 1520 OH * 1521 OH	Eixo Traseiro / Eje Trasero / Rear Axle
			VOLKSWAGEN	7-100 * 8-120 * 8-140 (CE*CO) * 8-150 * 9-150 OD 8-150	
			FAMSA	DC 9964 Autocar	
			FIAT	130 (76...) 130 OD (78...) 70 (77...) * 80	
			FORD	Cargo 814 F 100 (61...80 Diesel) * F 600 (56...77 Gas.) * F 700 (77...80) * F 750 (72...77) * 750 * 2000 * 4000 F 11000 * F 12000 F 13000 * F 14000 * F 16000 F 19000 (77...) * F 21000 * F 22000 F 7000 * FT 7000 e FT 8000 (77...80); F 8000 e F 8500 (77...79) * FT 8500	
			GENERAL MOTORS	6-100 (4X2)* 6-150* 12-170 L*S (4X2)* 1 4-190 (77...) (4X2)* 15-190 (77...) (4X2)* 16-220 (4X2) A-C-D 60* 70* 80* 90* 99 Turbo e 3500 Heavy Duty	
			MERCEDES BENZ	1513 (L*LA*LAK*LB*LG*LK*LS) * 1514 (L*LK*LS) * 1516 (L*LA*LAK*LB*LG*LK*LS) * 1517 (L*LK) * 1518 (L*LK*LS) * 1519 (L*LAK*LB*LG*LK*LS) * 1520 (L*LK*LP*LPK*LPS*LS) * 1521 L * 1524 e 1525 (L*LK*LS) 1517 OF * 1518 OF * 1520 OF	
			VOLKSWAGEN	11-130 * 11-140 * 11-160 12-140 * 12-140 H * 12-140 T * 12-170 BT 6-80 * 6-90 * 6-90 (P*S) D 1400 TD * Volksbus E 13 * E 21	
			MERCEDES BENZ	1513 (L*LA*LAK*LB*LG*LK*LS) * 1514 (L*LK*LS) * 1516 (L*LA*LAK*LB*LG*LK*LS) * 1517 (L*LK) * 1518 (L*LK*LS) * 1519 (L*LAK*LB*LG*LK*LS) * 1520 (L*LK*LP*LPK*LPS*LS) * 1521 L * 1524 e 1525 (L*LK*LS) 1517 OF * 1518 OF * 1520 OF 331 (L*LPK*LPS) 60...68	
			FORD	F 350 F 400	
			GENERAL MOTORS	D 40	
			HM 807046 / HM 807011	TRB	
HM 807049 / HM 807010	TRB		MERCEDES BENZ	L2221	Eixo Traseiro / Eje Trasero / Rear Axle
HM 813841 / HM 813810	TRB		MERCEDES BENZ	OMC 1425 51 Allegro	Eixo Traseiro / Eje Trasero / Rear Axle
HM 813842 / HM 813810	TRB		FORD	F 100 (61...80 Diesel) * F 600 (56...77 Gas.) * F 700 (77...80) * F 750 (72...77) * 750 * 2000 * 4000 F 13000 * F 14000 * F 16000	Eixo Traseiro / Eje Trasero / Rear Axle
HM 813843 / HM 813810	TRB		MASA	Ursus	Eixo Traseiro / Eje Trasero / Rear Axle
			MOTOR COACH	F12	
			VOLVO	Busscar dos y tres ejes U 12 * U 18 Articulado	
			DINA	776	
HM 813849 / HM 813810	TRB		FREIGHTLINER	Argosy C-120 * Columbia * Coronado * CST 120	Caixa de Mudanças / Caja de Cambios / Gearbox
			DINA	434 17570 Shuttle Bus	Eixo Traseiro / Eje Trasero / Rear Axle
HM 88542 / HM 88510	TRB		CHRYSLER	Ram 6500	Eixo Traseiro / Eje Trasero / Rear Axle
			FIAT	70 (77...) * 80	







Fersa®			Brand / Marca / Marca	Model / Modelo / Modelo	Application / Aplicação / Aplicaciones
HM 88542 / HM 88510	TRB		FORD	F-350 * P-350	Eixo Traseiro / Eje Trasero / Rear Axle
			FORD	F 2000 (80...)	Diferencial / Diferencial / Differential
				F 4000 (75...)	
			Sierra (L * XR3 * S)		
HM 88649 / HM 88610	TRB		CHRYSLER	Dakota	Diferencial / Diferencial / Differential
			FORD	F 1000 (79...)	
			GENERAL MOTORS	Caravan * Opala	
HM 88649 / HM 88610	TRB		FORD	Explorer Sierra (L * XR3 * S)	Diferencial / Diferencial / Differential
HM 89443 / HM 89411	TRB		FORD	F-350 Super Duty	Eixo Traseiro / Eje Trasero / Rear Axle
HM 89449 / HM 89410	TRB		GENERAL MOTORS	Omega * Omega Suprema (2.0 * 2.2 * 3.0 * 4.1)	Diferencial / Diferencial / Differential
				Omega * Suprema	
			MITSUBISHI	Pajero I (2.5 * 2.8 * 3.0 * 3.5)	Eixo Traseiro / Eje Trasero / Rear Axle
HM 903249 / HM 903210	TRB		DINA	500 Serie	Eixo Traseiro / Eje Trasero / Rear Axle
			CHRYSLER	D-600 * PD-600	
			DINA	400 Serie	
			FORD	531 K * 532 J	
			GENERAL MOTORS	F-600 * B-600	
			DINA	C-3500	
			DINA	500 * 501	
			References Fersa with Multiple Applications / Referências Fersa com Múltiplas Aplicações / Referencias Fersa con Multiples Aplicaciones		
HM 905843 / HM 905810	TRB		References Fersa with Multiple Applications / Referências Fersa com Múltiplas Aplicações / Referencias Fersa con Multiples Aplicaciones		
HM 911245 / HM 911210	TRB		VOLVO	B 10R * B 12B * B 12R * B 58 * B 58BR * B 7R * B9	Eixo Traseiro / Eje Trasero / Rear Axle
				B 58	
				B 58 BR (...Chassi 304120)	
			VOLVO	FH 12 * FH 16	Eixo Traseiro / Eje Trasero / Rear Axle
				N * NL 10 BR * N * NL 12 BR * N 10BR Mark II * NL 10BR 6x2	
				NH 12 * FM 12	
JD 6549 / JD 6510	TRB		SCANIA	94I * 94H * 94U * P94 CB (6x4*4x2) * 114L * P114 * T114 CB (6x4*4x2) * 124E * R124 * K124 CA (6x4*6x2) * T124 * P124 CA * CB (6x4*4x2) * 164 * P230 * P270 * P310 * P340 * P420 * R380 * R420 * R480	Caixa de Mudanças / Caja de Cambios / Gearbox
JF 10049 / JF 10010	TRB		SCANIA	94I * 94H * 94U * P94 CB (6x4*4x2) * 114L * P114 * T114 CB (6x4*4x2) * 124E * R124 * K124 CA (6x4*6x2) * T124 * P124 CA * CB (6x4*4x2) * 164 * P230 * P270 * P310 * P340 * P420 * R380 * R420 * R480	Eixo Traseiro / Eje Trasero / Rear Axle
JF 4049 / JF 4010	TRB		SCANIA	94I * 94H * 94U * P94 CB (6x4*4x2) * 114L * P114 * T114 CB (6x4*4x2) * 124E * R124 * K124 CA (6x4*6x2) * T124 * P124 CA * CB (6x4*4x2) * 164 * P230 * P270 * P310 * P340 * P420 * R380 * R420 * R480	Eixo Traseiro / Eje Trasero / Rear Axle Caixa de Mudanças / Caja de Cambios / Gearbox
JF 4549 / JF 4510	TRB		VOLVO	7550 9700	Motor / Motor / Engine
JF 5049 / JF 5010	TRB		SCANIA	94I * 94H * 94U * P94 CB (6x4*4x2) * 114L * P114 * T114 CB (6x4*4x2) * 124E * R124 * K124 CA (6x4*6x2) * T124 * P124 CA * CB (6x4*4x2) * 164 * P230 * P270 * P310 * P340 * P420 * R380 * R420 * R480	Caixa de Mudanças / Caja de Cambios / Gearbox
JF 6049 / JF 6010	TRB		References Fersa with Multiple Applications / Referências Fersa com Múltiplas Aplicações / Referencias Fersa con Multiples Aplicaciones		
JH 211749 / JH 211710	TRB		DINA	F11 * F12 * F14	Eixo Traseiro / Eje Trasero / Rear Axle
				Marco Polo	
				Viaggio	
			DINA	751 Multi Torque	
				861 K	
			FREIGHTLINER	FLD 120	
				FS 65	
			KENWORTH	T2000	
				T 600 Aerocab, B, Modular T800 * Aerocab * Modular * SHW (Short hood wide) * HB * BSH Aerocab * SH 6X4 * 8X4 W900 * W924	











Fersa®			Brand / Marca / Marca	Model / Modelo / Modelo	Application / Aplicação / Aplicaciones		
JHM 522649 / JHM 522610	TRB		SCANIA	K 124 CA (6x4 * 6x2) P 93 * R 113 * R 143 * T 113	Eixo Traseiro / Eje Trasero / Rear Axle		
			SCANIA	94I * 94H * 94U * P94 CB (6x4*4x2) * 114L * P114 * T114 CB (6x4*4x2) * 124E * R124 * K124 CA (6x4*6x2) * T124 * P124 CA * CB (6x4*4x2) * 164 * P230 * P270 * P310 * P340 * P420 * R380 * R420 * R480 F 113 * L 113 * K 113 P 114 * R 124 * T 114 CB 6x4 * 4x2 * T 124 P 94 CB (4x2 * 6x2 * 6X4)			
				STERLING		L7500	
				JHM 720249 / JHM 720210		TRB	STERLING
		JL 26749 F / JL 26710	TRB			CHRYSLER	Dart K
LeBaron							
New Yorker							
Phantom							
Shadow							
Spirit							
Volare K							
JL 69349 / JL 69310	TRB		DODGE	D150	Eixo Dianteiro / Eje Delantero / Front Axle		
				D250			
				D350			
				Ram 2500			
				Ram Van * Wagon 2500			
			FORD	Expedition			
				F 150			
				Grand Marquis			
			GENERAL MOTORS	Astra		Diferencial / Diferencial / Differential	
				Ipanema* Kadett * Monza (1.8 * 2.0)			
				Vectra			
Zafira (1.8 * 2.0)	PEUGEOT	205	Diferencial / Diferencial / Differential				
				JL 69349 X / JL 69310			
JL 819349 / JL 819310	TRB	References Fersa with Multiple Applications / Referências Fersa com Múltiplas Aplicações / Referencias Fersa con Multiples Aplicaciones					
JLM 104946 / JLM 104911 A	TRB		FORD	F-350 Super Duty	Eixo Traseiro / Eje Trasero / Rear Axle		
JLM 104948 / JLM 104910	TRB		TOYOTA	Bandeirante	Eixo Dianteiro / Eje Delantero / Front Axle		
				Hilux	Eixo Traseiro / Eje Trasero / Rear Axle		
				Land Cruiser	Eixo Dianteiro / Eje Delantero / Front Axle		
					Eixo Traseiro / Eje Trasero / Rear Axle		
References Fersa with Multiple Applications / Referências Fersa com Múltiplas Aplicações / Referencias Fersa con Multiples Aplicaciones							
JLM 506849 A / JLM 506811	TRB	References Fersa with Multiple Applications / Referências Fersa com Múltiplas Aplicações / Referencias Fersa con Multiples Aplicaciones					
JLM 508748 / JLM 508710	TRB		SCANIA	111 (L*LS*LT)	Eixo Traseiro / Eje Trasero / Rear Axle		
				SCANIA		R 112 (81...) T 142 E (6X4)	
JLM 710949 / JLM 710910	TRB		DINA	D-Avante Plus * D-Dorado	Eixo Traseiro / Eje Trasero / Rear Axle		
			Viaggio				
JLM 710949 C / JLM 710910	TRB		FREIGHTLINER	FC 70	Eixo Traseiro / Eje Trasero / Rear Axle		
			FREIGHTLINER	FL 112QR 6X4			
JLM 714149 / JLM 714110	TRB		DINA	F11 * F12 * F14	Eixo Traseiro / Eje Trasero / Rear Axle		
				Marco Polo			
				Viaggio			
				DINA		751 Multi Torque	
		861 K					
		FREIGHTLINER		FL 70			
				FLD 120			
		FS 65					





Fersa®			Brand / Marca / Marca	Model / Modelo / Modelo	Application / Aplicação / Aplicaciones	
JLM 714149 / JLM 714110	TRB		KENWORTH	T2000	Eixo Traseiro / Eje Trasero / Rear Axle	
				T 600 Aerocab, B, Modular		
				T800 * Aerocab * Modular * SHW (Short hood wide) * HB * BSH Aerocab * SH 6X4 * 8X4		
				W900 * W924		
				MBO 1017		
MERCEDES BENZ	MBO 1018 44					
	MBO 1019 44 Boxer					
JM 205149 / JM 205110	TRB	References Fersa with Multiple Applications / Referências Fersa com Múltiplas Aplicações / Referencias Fersa con Multiples Aplicaciones				
JM 207049 / JM 207010	TRB		DINA	Citus 11000 * 9500	Eixo Dianteiro / Eje Delantero / Front Axle	
			DINA	604 G1 * 604 G3 * 604 L1 * 604 L5 * 631 K1 * 631 K3 * 661 C1 * 661 G1 * 661 G2 * 661 G3	Eixo Traseiro / Eje Trasero / Rear Axle	
				D9 160 * D12 160 Cab Over		
			MERCEDES BENZ	MBO 1017	Eixo Dianteiro / Eje Delantero / Front Axle	
MERCEDES BENZ						
JM 207049 A / JM 207010	TRB		DINA	434 17570 Shuttle Bus	Eixo Dianteiro / Eje Delantero / Front Axle	
			DINA	400 Serie		
				FC 70		
				FL 60		
			FREIGHTLINER	MT45 * MT45A. M2 52K 6X2		
				MBO 1018 44		
			MERCEDES BENZ	MBO 1019 44 Boxer	Eixo Traseiro / Eje Trasero / Rear Axle	
				STERLING	LT7500	
			DINA	451		
				433 16070		
455 OF						
MERCEDES BENZ	MBO 1018 44					
	MBO 1019 44 Boxer					
JM 511946 / JM 511910	TRB		DINA	D-Avante Plus * D-Dorado	Eixo Traseiro / Eje Trasero / Rear Axle	
			Viaggio			
FREIGHTLINER	FC 70					
JM 714249 / JM 714210	TRB		DODGE	400 * 450 * 700 * 750 * 900 * 950	Eixo Traseiro / Eje Trasero / Rear Axle	
			FORD	F 100 (61...80 Diesel) * F 600 (56...77 Gas.) * F 700 (77...80) * F 750 (72...77) * 750 * 2000 * 4000		
JM 716649 / JM 716610	TRB		DINA	D-Avante Plus * D-Dorado	Eixo Traseiro / Eje Trasero / Rear Axle	
				Viaggio		
				VOLKSWAGEN		22-140 * 22-210 * 23-210 * 23-220 * 23-250 E * 23-310 TITAN
						23-250
			VOLVO	C 10 * C 11		
				C 11R * C 12R		
			CHRYSLER	Ram 6500		
			FORD	Cargo 1113 * 1114 * 1116 * 1117		
				Cargo 1215		
				Cargo 1313 * 1314 * 1317 * 1317E		
				Cargo 1415 * 1416		
				Cargo 1422 * 1514 * 1517 * 1517E * 1615 * 1615T * 1617 * 1618 * 1618T * 1619 * 1621 * 1622 * 1717E * 1722 * 1722E * 2216 * 2217 * 2218 * 2218T * 2319 * 2322 * 2324 * 2422 * 2422E * 2425 * 2428E * 2630 * 3224 * 3530 * 4030		
				F 11000 * F 12000		
				F 13000 * F 14000 * F 16000		
F 19000 (77...) * F 21000 * F 22000						
LM-700						
FREIGHTLINER	FC 70					
	FC 80					
	FL 112QR 6X4					
	FL 70					
	L-112					







Fersa®			Brand / Marca / Marca	Model / Modelo / Modelo	Application / Aplicação / Aplicaciones					
JM 716649 / JM 716610	TRB		INTERNATIONAL	4400-215HP 4X2 * 4400-250HP * 4400-285HP * 4400-300HP	Eixo Traseiro / Eje Trasero / Rear Axle					
			KENWORTH	T450, T450 B, T450 W						
			SCANIA	R 112 (81...) T 142 E (6X4)						
			VOLKSWAGEN	14-140 * 14-150 * 14-170 BT * 14-180 * 14-200 * 14-210 * 14-220						
				15-170 * 15-170E * 15-180 * 15-180E * 15-180 OD * 15-190 (77...) * 15-190 (77...)EOD						
				16-170 * 16-180 * 16-200 * 16-210 * 16-220 CO * 16300						
D 1400 TD * Volksbus E 13 * E 21										
JM 720249 / JM 720210	TRB		SCANIA	K 114 IB (4X2) Busscar	Eixo Traseiro / Eje Trasero / Rear Axle					
				K 114 IB (4X2) LB 340 Irizar						
				K 114 IB 4X2 NB 340 K						
				K 124 CA (6x4 * 6x2)						
				K 124 IB 4X2 Vissta Bus						
				L 114 IB (4X2) LB 340 Urbanuss						
	L 94 VB (4X2) 220HP Urbanuss									
	TRB		SCANIA	LA 94 UB 4X2 LB * LA 6X4 NA						
				P 114 * R 124 * T 114 CB 6x4 * 4x2 * T 124						
				P 114 CB 6X4 NA 340						
				P 94 CB (4x2 * 6x2 * 6X4)						
				R 124 GA 4X2 NA400						
T 124 GA 6X4 * T 124 LA 6X4 NA400										
JP 12049 / JP 12010	TRB		FORD	Cargo 1113 * 1114 * 1116 * 1117	Eixo Traseiro / Eje Trasero / Rear Axle					
				Cargo 1215						
				Cargo 1313 * 1314 * 1317 * 1317E						
				Cargo 1415 * 1416						
				Cargo 1422 * 1514 * 1517 * 1517E * 1615 * 1615T * 1617 * 1618 * 1618T * 1619 * 1621 * 1622 * 1717E * 1722 * 1722E * 2216 * 2217 * 2218 * 2218T * 2319 * 2322 * 2324 * 2422 * 2422E * 2425 * 2428E * 2630 * 3224 * 3530 * 4030						
				F 11000 * F 12000						
				F 13000 * F 14000 * F 16000						
				F 19000 (77...) * F 21000 * F 22000						
				JP 12049 A / JP 12010		TRB	References Fersa with Multiple Applications / Referências Fersa com Múltiplas Aplicações / Referencias Fersa con Multiples Aplicaciones			
JW 7049 / JW 7010	TRB	References Fersa with Multiple Applications / Referências Fersa com Múltiplas Aplicações / Referencias Fersa con Multiples Aplicaciones								
KA 019	KIT		FORD	Escort	Eixo Dianteiro / Eje Delantero / Front Axle					
				Escort Hobby						
				Verona						
KA 021	KIT		VOLKSWAGEN	Apollo	Eixo Traseiro / Eje Trasero / Rear Axle					
				FORD		Escort				
						Fiesta				
KA 038	KIT		GENERAL MOTORS	Celta * Classic * Corsa * Corsa Sedan * Pick-up Corsa	Eixo Traseiro / Eje Trasero / Rear Axle					
				Monza * Kadett * Ipanema						
				KA 040		KIT		GENERAL MOTORS	Chevette * Chevette Junior * Chevy 500 * Marajó	Eixo Dianteiro / Eje Delantero / Front Axle
KA 069	KIT		FORD		Royale				Eixo Traseiro / Eje Trasero / Rear Axle	
					Versailles					
				VOLKSWAGEN	Gol * Parati * Voyage * Saveiro					
Golf										
Passat										
Santana * Santana Quantum (1.6 * 1.8 * 2.0)										







Fersa®			Brand / Marca / Marca	Model / Modelo / Modelo	Application / Aplicação / Aplicaciones
KA 075	KIT		FORD	Escort Verona	Eixo Traseiro / Eje Trasero / Rear Axle
			VOLKSWAGEN	Apollo	
KA 273	KIT		MERCEDES BENZ	Sprinter 313 * 413	Eixo Dianteiro / Eje Delantero / Front Axle
KF 145	KIT		CITROËN	C3	Eixo Dianteiro / Eje Delantero / Front Axle
			PEUGEOT	206	
KV 164	KIT		ALFA ROMEO	Alfa 145	Eixo Traseiro / Eje Trasero / Rear Axle
			FIAT	Brava	
				Doblò	
				Marea * Marea Weekend	
				Palio * Palio Weekend * Siena	
				Stilo	
				Tempra	
Tipo					
N 307 FM	TRB	References Fersa with Multiple Applications / Referências Fersa com Múltiplas Aplicações / Referencias Fersa con Multiples Aplicaciones			
L 44649 / L 44610	TRB		CHRYSLER	1800 Dart K	Eixo Dianteiro / Eje Delantero / Front Axle
			DODGE	Atos	Eixo Traseiro / Eje Trasero / Rear Axle
			FORD	Belina * Belina II * Corcel * Corcel II Del Rey * Pampa	
				Scala	
			GENERAL MOTORS	Caravan * Opala Chevette * Chevette Junior * Chevy 500 * Marajó	Eixo Dianteiro / Eje Delantero / Front Axle
			NISSAN	Datsun	
		VOLKSWAGEN	1600 * 1600TL		
			BALDAN	Arado Subsolador ASDACR * ASDADR * ASDAH Carpideira CED Tandem * Carpideira Fixa Leve Semeadeira SD 5000 * Terraceador de Arrasto TACR	Arado / Arado / Plow Roçadeira / Desbrozadora / Weed Eating
			AUDI	A4	Eixo Traseiro / Eje Trasero / Rear Axle
			DAEWOO	Ciello	
Espero					
Lanos					
Nubira					
Racer					
FAW	F1 Sedan				
	F4				
L 45449 / L 45410	TRB		FORD	Escort	Câmbio / Caja de Cambios / Gearbox
				Escort Hobby	Eixo Traseiro / Eje Trasero / Rear Axle
				Ghia	
				Royale	
				Topaz	
			Verona	Câmbio / Caja de Cambios / Gearbox	
				Verona	Eixo Traseiro / Eje Trasero / Rear Axle
				Versailles	
			GENERAL MOTORS	Astra	Eixo Traseiro / Eje Trasero / Rear Axle
				Celta * Classic * Corsa * Corsa Sedan * Pick-up Corsa	
Chevy					
Monza * Kadett * Ipanema					
Tigra					
GURGEL	BR 800	Eixo Dianteiro / Eje Delantero / Front Axle			
NISSAN	Samurai	Eixo Traseiro / Eje Trasero / Rear Axle			
	Tsuru I				





Fersa®			Brand / Marca / Marca	Model / Modelo / Modelo	Application / Aplicação / Aplicaciones
L 45449 / L 45410	TRB		SEAT	Cordoba	Eixo Traseiro / Eje Trasero / Rear Axle
				Ibiza	
				Toledo	
			VOLKSWAGEN	1600 * 1600TL	Eixo Dianteiro / Eje Delantero / Front Axle
				Apollo	Câmbio / Caja de Cambios / Gearbox
				Atlantic	Eixo Traseiro / Eje Trasero / Rear Axle
				Brasília	Eixo Dianteiro / Eje Delantero / Front Axle
				Cabrio	Eixo Traseiro / Eje Trasero / Rear Axle
				Caribe	
				Corrado	
				Corsar	
				Derby	
				Fusca	Eixo Dianteiro / Eje Delantero / Front Axle
				Gol	Eixo Traseiro / Eje Trasero / Rear Axle
				Gol * Parati * Voyage * Saveiro	
				Golf	Câmbio / Caja de Cambios / Gearbox
				Jetta	Eixo Traseiro / Eje Trasero / Rear Axle
				Karmann Ghia	Eixo Dianteiro / Eje Delantero / Front Axle
				Logus	Câmbio / Caja de Cambios / Gearbox
				Logus (1.6 * 1.8)	
				Passat	Eixo Traseiro / Eje Trasero / Rear Axle
				Passat 2.8 VR10	
				Pointer	Câmbio / Caja de Cambios / Gearbox
				Pointer (1.8 * 2.0)	Eixo Traseiro / Eje Trasero / Rear Axle
				Polo	Câmbio / Caja de Cambios / Gearbox
				Polo Classic	
			Santana * Santana Quantum (1.6 * 1.8 * 2.0)	Eixo Traseiro / Eje Trasero / Rear Axle	
			Sedan	Eixo Dianteiro / Eje Delantero / Front Axle	
TC					
Variant					
Vento	Eixo Traseiro / Eje Trasero / Rear Axle				
L 68149 / L 68110	TRB		FORD	F 150	Eixo Dianteiro / Eje Delantero / Front Axle
L 68149 / L 68111	TRB		CHRYSLER	Crossfire	Eixo Dianteiro / Eje Delantero / Front Axle
				LeBaron	
			DODGE	Caravan	Eixo Traseiro / Eje Trasero / Rear Axle
			FORD	Cougar	Eixo Dianteiro / Eje Delantero / Front Axle
PONTIAC	Mustang				
LM 102949 / LM 102910	TRB		FORD	F-350 * P-350	Eixo Dianteiro / Eje Delantero / Front Axle
				F 250	
				F 350	
				Microbus	







Fersa®			Brand / Marca / Marca	Model / Modelo / Modelo	Application / Aplicação / Aplicaciones
LM 104949 / LM 104910	TRB		DINA	434 17570 Shuttle Bus	Eixo Traseiro / Eje Trasero / Rear Axle
				D-Avante Plus * D-Dorado	
				F11 * F12 * F14	
				Marco Polo	
				Viaggio	
			DINA	751 Multi Torque	
				861 K	
			FREIGHTLINER	FC 70	
				FLD 120	
				FS 65	
			KENWORTH	T2000	
				T 600 Aerocab, B, Modular	
T800 * Aerocab * Modular * SHW (Short hood wide) * HB * BSH Aerocab * SH 6X4 * 8X4					
W900 * W924					
	JOHN DEERE	Diversos	Eixo / Eje / Axle		
LM 104949 / LM 104911	TRB		FORD	F-350 * P-350	Eixo Traseiro / Eje Trasero / Rear Axle
			GENERAL MOTORS	C-3500	
			SUDISA	EA4	Eixo / Eje / Axle
		EE4 * EH4			
			JOHN DEERE	Diversos	Eixo Traseiro / Eje Trasero / Rear Axle
		DODGE	D150		
			D250		
			D350		
			Ram 2500		
			Ram 3500		
			Ram 4000		
			Ram Van * Wagon 3500		
			Excursion		
			F 250		
			F 350		
			F 450		
			Microbus		
			Mustang		
			GENERAL MOTORS	C 2500	
		C 3500			
		Express Van			
P 30					
Silverado 2500					
Silverado 3500					
Suburban					
					
LM 104949 / LM 104912	TRB		JOHN DEERE	Diversos	Eixo / Eje / Axle
LM 11749 / LM 11710	TRB		DAEWOO	Ciello	Eixo Traseiro / Eje Trasero / Rear Axle
				Espero	
				Lanos	
				Nubira	
				Racer	
			DODGE	Atos	
		FORD	Courier	Câmbio / Caja de Cambios / Gearbox	
			Escort	Eixo Traseiro / Eje Trasero / Rear Axle	
			Escort Hobby		
			Fiesta	Câmbio / Caja de Cambios / Gearbox	
			Ka		
			Royale		
			Verona	Eixo Traseiro / Eje Trasero / Rear Axle	
Versailles					













Fersa®			Brand / Marca / Marca	Model / Modelo / Modelo	Application / Aplicação / Aplicaciones
LM 11749 / LM 11710	TRB		GENERAL MOTORS	Astra	Eixo Traseiro / Eje Trasero / Rear Axle
				Caravan * Opala	Diferencial / Diferencial / Differential
				Celta * Classic * Corsa * Corsa Sedan * Pick-up Corsa	Eixo Dianteiro / Eje Delantero / Front Axle
				Chevette * Chevette Junior * Chevy 500 * Marajó	Eixo Traseiro / Eje Trasero / Rear Axle
				Chevy	Eixo Dianteiro / Eje Delantero / Front Axle
				Marajó (1.0 * 1.4 * 1.6)	Eixo Traseiro / Eje Trasero / Rear Axle
				Monza * Kadett * Ipanema	Diferencial / Diferencial / Differential
				Tigra	Eixo Traseiro / Eje Trasero / Rear Axle
			GURGEL	BR 800	Eixo Dianteiro / Eje Delantero / Front Axle
			NISSAN	Datsun	Eixo Dianteiro / Eje Delantero / Front Axle
			SEAT	Cordoba	Eixo Traseiro / Eje Trasero / Rear Axle
				Ibiza	Eixo Traseiro / Eje Trasero / Rear Axle
				Toledo	Eixo Traseiro / Eje Trasero / Rear Axle
			VOLKSWAGEN	1600 * 1600TL	Eixo Dianteiro / Eje Delantero / Front Axle
				Apollo	Eixo Traseiro / Eje Trasero / Rear Axle
				Atlantic	Eixo Traseiro / Eje Trasero / Rear Axle
				Brasília	Eixo Dianteiro / Eje Delantero / Front Axle
				Cabrio	Eixo Dianteiro / Eje Delantero / Front Axle
				Caribe	Eixo Dianteiro / Eje Delantero / Front Axle
				Corrado	Eixo Traseiro / Eje Trasero / Rear Axle
				Corsar	Eixo Traseiro / Eje Trasero / Rear Axle
				Derby	Eixo Traseiro / Eje Trasero / Rear Axle
				Fusca	Eixo Dianteiro / Eje Delantero / Front Axle
				Gol	Eixo Dianteiro / Eje Delantero / Front Axle
				Gol * Parati * Voyage * Saveiro	Eixo Traseiro / Eje Trasero / Rear Axle
				Golf	Eixo Traseiro / Eje Trasero / Rear Axle
				Jetta	Eixo Traseiro / Eje Trasero / Rear Axle
				Karmann Ghia	Eixo Dianteiro / Eje Delantero / Front Axle
				Passat	Eixo Dianteiro / Eje Delantero / Front Axle
				Passat 2.8 VR12	Eixo Traseiro / Eje Trasero / Rear Axle
				Pointer	Eixo Traseiro / Eje Trasero / Rear Axle
				Santana * Santana Quantum (1.6 * 1.8 * 2.0)	Eixo Dianteiro / Eje Delantero / Front Axle
				Sedan	Eixo Dianteiro / Eje Delantero / Front Axle
TC	Eixo Dianteiro / Eje Delantero / Front Axle				
Variant	Eixo Dianteiro / Eje Delantero / Front Axle				
Vento	Eixo Traseiro / Eje Trasero / Rear Axle				
LM 11949 / LM 11910	TRB		AUDI	A4	Eixo Traseiro / Eje Trasero / Rear Axle
			CHRYSLER	1800	Eixo Dianteiro / Eje Delantero / Front Axle
				D 100	Eixo Dianteiro / Eje Delantero / Front Axle
				Dart	Eixo Dianteiro / Eje Delantero / Front Axle
				Dart K	Eixo Traseiro / Eje Trasero / Rear Axle
				Gran Sedan	Eixo Traseiro / Eje Trasero / Rear Axle
				Le Baron	Eixo Dianteiro / Eje Delantero / Front Axle
				Magnum	Eixo Traseiro / Eje Trasero / Rear Axle
				New Yorker	Eixo Dianteiro / Eje Delantero / Front Axle
			FAW	F1 Sedan	Eixo Traseiro / Eje Trasero / Rear Axle
			F4	Eixo Traseiro / Eje Trasero / Rear Axle	









Fersa*			Brand / Marca / Marca	Model / Modelo / Modelo	Application / Aplicação / Aplicaciones
LM 11949 / LM 11910	TRB		FORD	Belina * Belina II * Corcel * Corcel II	Eixo Traseiro / Eje Trasero / Rear Axle
				Del Rey * Pampa	
				Explorer	
				F 100	
				F 1000 (79...)	
				Galaxie 500	Eixo Dianteiro / Eje Delantero / Front Axle
				Landau	
				Limited	
				Ranger	
			Scala	Eixo Traseiro / Eje Trasero / Rear Axle	
			GENERAL MOTORS	A-C-D (10*14*15*20*40) * Bonanza * Veraneio * D1000	
				Caprice	Eixo Dianteiro / Eje Delantero / Front Axle
				Caravan * Opala	
				S 10 (2.2 * 2.4 * 2.5 * 2.8 TD * 4.3)	Câmbio / Caja de Cambios / Gearbox
		LADA	S 10 * Blazer		
			1600	Eixo Dianteiro / Eje Delantero / Front Axle	
		NISSAN	Ichivan		
			Samurai	Eixo Traseiro / Eje Trasero / Rear Axle	
		VOLKSWAGEN	Tsuru I		
			Combi		
			Kombi	Eixo Dianteiro / Eje Delantero / Front Axle	
			Panel		
		AGCO MAXION		Colhedeira Combinada Automotriz 1170DS * 1175DS * 1630 Arroeira * 3640 Arroeira * 5650 * MF 220A * 220CBD * 220STD * MF 310CBD * 310STD * 210 * 210S * 220 * 310	Eixo Traseiro / Eje Trasero / Rear Axle
				Roçadeira MF 880	Motor / Motor / Engine
					Acionador da Polia / Accionador de Polea / Drive Pulley
				Tratores MF 235 (4x4) Antigo * MF 235 Moderno* 250 * 265 * MF265 RD * 270 * 274 * 275 * 285 * 290 * MF 292 (4x4) * 295 * 296 * 299	Câmbio / Caja de Cambios / Gearbox
					Eixo Dianteiro / Eje Delantero / Front Axle
	Tomada de Potência / Toma de Potencia / Power Take-off				
	Acionador da Polia / Accionador de Polea / Drive Pulley				
Tratores MF (50X * 55X * 65R * 65X * 85 * 85X * 95 * 95X)	Câmbio / Caja de Cambios / Gearbox				
	Eixo Dianteiro / Eje Delantero / Front Axle				
	Tomada de Potência / Toma de Potencia / Power Take-off				
FNH	Tratores 4600 * 4610 * 4630 * 5600 * 5610 * 5630 * 6600 * 6610 * 6630 * 7610 * 7630 * 7810 * 7830 * 8030 * 8BR	Eixo Dianteiro / Eje Delantero / Front Axle			
LM 12748 / LM 12710	TRB		GENERAL MOTORS	S 10	Eixo Dianteiro / Eje Delantero / Front Axle
LM 12749 / LM 12710	TRB		CHRYSLER	Crossfire	Eixo Traseiro / Eje Trasero / Rear Axle
				Dart K	
				LeBaron	
				New Yorker	
				Phantom	
				Shadow	
				Spirit	
				Volare K	
			FORD	Cougar	Eixo Dianteiro / Eje Delantero / Front Axle
				Expedition	
				F 150	Eixo Traseiro / Eje Trasero / Rear Axle
				Ghia	
				Grand Marquis	Eixo Dianteiro / Eje Delantero / Front Axle
Mustang					







Fersa®			Brand / Marca / Marca	Model / Modelo / Modelo	Application / Aplicação / Aplicaciones
LM 12749 / LM 12710	TRB		FORD	Taurus	Eixo Traseiro / Eje Trasero / Rear Axle
				Thunderbird	Eixo Dianteiro / Eje Delantero / Front Axle
				Topaz	Eixo Traseiro / Eje Trasero / Rear Axle
				Windstar	Eixo Traseiro / Eje Trasero / Rear Axle
LM 12749 / LM 12711	TRB		DODGE	Caravan	Eixo Traseiro / Eje Trasero / Rear Axle
				D150	Eixo Dianteiro / Eje Delantero / Front Axle
				D250	
				D350	
				Ram 2500	
Ram Van * Wagon 2500					
LM 29749 / LM 29710	TRB		FORD	Escort	Câmbio / Caja de Cambios / Gearbox
				Verona	
			NISSAN	Samurai	Eixo Dianteiro / Eje Delantero / Front Axle
				Tsuru I	
			VOLKSWAGEN	Apollo	Câmbio / Caja de Cambios / Gearbox
				Diferencial / Diferencial / Differential	
				Golf A4	Câmbio / Caja de Cambios / Gearbox
				Golf	
				Logus	
				Logus (1.6 * 1.8)	
				Pointer	
				Pointer (1.8 * 2.0)	
			Polo		
Polo Classic					
Santana * Santana Quantum (1.6 * 1.8 * 2.0)	Diferencial / Diferencial / Differential				
LM 29749 / LM 29711	TRB		GENERAL MOTORS	Caravan * Opala	Diferencial / Diferencial / Differential
				Chevette * Chevette Junior * Chevy 500 * Marajó	
LM 300849 / LM 300811	TRB		FORD	Del Rey * Pampa	Diferencial / Diferencial / Differential
				Escort	Câmbio / Caja de Cambios / Gearbox
				Versailles	Diferencial / Diferencial / Differential
			GENERAL MOTORS	Caravan * Opala	Câmbio / Caja de Cambios / Gearbox
				D21	Eixo Dianteiro / Eje Delantero / Front Axle
			Frontier		
			Pathfinder		
			Pick Up 2200 4 x 4		
			Pick Up 2500 4 x 4		
			Pick Up 2700 4 x 4		
			Terrano		
			X-Terra		
			VOLKSWAGEN	Gol * Parati	Diferencial / Diferencial / Differential
				Gol (1.3 * 1.6)	Câmbio / Caja de Cambios / Gearbox
				Gol * Parati * Voyage * Saveiro	
				Golf A4	
				Kombi	
				Kombi (1500 * 1600)	Diferencial / Diferencial / Differential
				Logus	Câmbio / Caja de Cambios / Gearbox
				Passat	
Passat (1.5 * 1.6 * 1.8)	Diferencial / Diferencial / Differential				
Pointer	Câmbio / Caja de Cambios / Gearbox				
Polo	Diferencial / Diferencial / Differential				
Polo Classic					
Santana * Santana Quantum (1.6 * 1.8 * 2.0)	Câmbio / Caja de Cambios / Gearbox				
Saveiro * Voyage	Diferencial / Diferencial / Differential				









Fersa®			Brand / Marca / Marca	Model / Modelo / Modelo	Application / Aplicação / Aplicaciones
LM 48548 / LM 48510	TRB		VOLKSWAGEN	D 1400 TD * Volksbus E 13 * E 21	Caixa de Mudanças / Caja de Cambios / Gearbox
			CHRYSLER	1800	Diferencial / Diferencial / Differential
				D 100	Eixo Dianteiro / Eje Delantero / Front Axle
			DODGE	H100	
				Ram 1500	
			Ram Van * Wagon 1500		
				FORD	
			F 1000 (79...)		
			Galaxie 500		
			Landau		
			Limited		
			Ranger		
			Thunderbird		
			GENERAL MOTORS	A-C-D (10*14*15*20*40) * Bonanza * Veraneio * D1000	
				Blazer	
				C 1500	
				C 2500	
			Luv		
				MITSUBISHI	
		L 300			
		NISSAN	D21		
			Frontier		
			Frontier		
		X-Terra			
			TOYOTA	Hilux	
			AGCO MAXION	Colheteira Combinada Automotriz 1170DS * 1175DS * 1630 Arroeira * 3640 Arroeira * 5650 * MF 220A * 220CBD * 220STD * MF 310CBD * 310STD * 210 * 210S * 220 * 310	Eixo Traseiro / Eje Trasero / Rear Axle
				Tratores MF 235 (4x4) Antigo * MF 235 Moderno* 250 * 265 * MF265 RD * 270 * 274 * 275 * 285 * 290 * MF 292 (4x4) * 295 * 296 * 299	Acionador da Polia / Accionador de Polea / Drive Pulley Câmbio / Caja de Cambios / Gearbox Eixo Dianteiro / Eje Delantero / Front Axle Tomada de Potência / Toma de Potencia / Power Take-off
				Tratores MF (50X * 55X * 65R * 65X * 85 * 85X * 95 * 95X)	Acionador da Polia / Accionador de Polea / Drive Pulley Câmbio / Caja de Cambios / Gearbox
			CBT	Tratores 1000 * 1000 (4x4) * 1020 * 1020 (4x4) * 1065 * 1065 (4x4) * 1090 * 1105	Eixo Dianteiro / Eje Delantero / Front Axle
				Tratores 8060 (4x2) * 8060 (4x4) * 8240 * 8240A * 8260 * 8440 * 8450	
			FNH	Colheteiras 4040 * 5030 * 5050 * 8040 * 8055 * TC55 * TC57 * CA1530	Eixo Traseiro / Eje Trasero / Rear Axle
				Tratores 4600 * 4610 * 4630 * 5600 * 5610 * 5630 * 6600 * 6610 * 6630 * 7610 * 7630 * 7810 * 7830 * 8030 * 8BR	Eixo Dianteiro / Eje Delantero / Front Axle
MARCHESAN	Arado Fixo AF * Arado Fixo Canavieiro AFC * Arado Fixo Leve AFL		Eixo Traseiro / Eje Trasero / Rear Axle		
	Distribuidor de Calcário & Adubo DCA 2 2500 * DCA 2 5500 * DCA 2 7500 * DCA DC 5500 * DCA DC 7500 * DCA DC 2500		Caixa de Redução / Caja de Reducción / Reduction Box		
	Distribuidor de Calcário * Composto Orgânico DCC0 10500 * DCC0 2500 * DCC0 5550 * DCC0 7500				
	Plantadeira Hidráulica Tatu PHT * PHT Suprema				
Roçadeira RC 2 4500 * Roçadeira de Arrasto RCA 3100 * RCA E 3400	Caixa de Distribuição / Caja de Distribución / Distribution Box				
VALTRA - VALMET	Tratores 110 ID * 110ID II * 118 * 118 (4x4) * 128 * 128 (4x4)	Eixo Dianteiro / Eje Delantero / Front Axle			



















Fersa®			Brand / Marca / Marca	Model / Modelo / Modelo	Application / Aplicação / Aplicaciones	
LM 501349 / LM 501310	TRB		DODGE	400 * 450 * 700 * 750 * 900 * 950	Eixo Dianteiro / Eje Delantero / Front Axle	
			FORD	F 100 (61...80 Diesel) * F 600 (56...77 Gas.) * F 700 (77...80) * F 750 (72...77) * 750 * 2000 * 4000		
				F-350 * P-350		
				F-350 Super Duty		
				F-450 * F-450 Super Duty		
			F-550 Super Duty			
		GENERAL MOTORS	6-100 (4X2)* 6-150* 12-170 L*S (4X2)* 14-190 (77...) (4X2)* 15-190 (77...) (4X2)* 16-220 (4X2) C-3500			
			CHRYSLER	Dakota	Diferencial / Diferencial / Differential	
			DODGE	D350	Eixo Dianteiro / Eje Delantero / Front Axle	
				Ram 2500		
				Ram Charger Ram Van * Wagon 2500		
			FORD	F 2000	Eixo Dianteiro / Eje Delantero / Front Axle	
				F 350		
				F 400 F 4000		
			GENERAL MOTORS	A-C-D (10*14*15*20*40) * Bonanza * Veraneio * D1000	Diferencial / Diferencial / Differential	
				C 3500		
				S 10 * Blazer		
			MERCEDES BENZ	Sprinter 313 * 413	Eixo Dianteiro / Eje Delantero / Front Axle	
				Sprinter 315		
				Sprinter 316		
				Sprinter 415		
				Sprinter 416 Sprinter 515		
				AGCO MAXION	Colheitadeira Combinada Automotriz 1170DS * 1175DS * 1630 Arrozadeira * 3640 Arrozadeira * 5650 * MF 220A * 220CBD * 220STD * MF 310CBD * 310STD * 210 * 210S * 220 * 310 Tratores MF 235 (4x4) Antigo * MF 235 Moderno* 250 * 265 * MF265 RD * 270 * 274 * 275 * 285 * 290 * MF 292 (4x4) * 295 * 296 * 299	Eixo Dianteiro / Eje Delantero / Front Axle
				FNH	Colheitadeiras 4040 * 5030 * 5050 * 8040 * 8055 * TC55 * TC57 * CA1530	Câmbio / Caja de Cambios / Gearbox
Todos / Todos / All / Todos / Todos / All / All	Eixo Dianteiro / Eje Delantero / Front Axle					
Tratores 4600 * 4610 * 4630 * 5600 * 5610 * 5630 * 6600 * 6610 * 6630 * 7610 * 7630 * 7810 * 7830 * 8030 * 8BR	Câmbio / Caja de Cambios / Gearbox Eixo Dianteiro / Eje Delantero / Front Axle Tomada de Força / Toma de Fuerza / Power Take-off Tração Dianteira / Tracción Delantera / Front Traction					
JOHN DEERE	Colheitadeiras CA1165 * CA1175 * CA1185 * CA1450 * CA1550-02 * CA1550-03 Colheitadeiras CA9650 * CA9750 STS	Tomada de Força / Toma de Fuerza / Power Take-off				
VALTRA - VALMET	Tratores 685 * 685C (4x4) * 785 * 785C (4x4) * 880 Cafeeiro * 880 (4x4) * 885 * 980 (4x4) * 985 * 985F * 1180 * 1184	Eixo Dianteiro / Eje Delantero / Front Axle				
LM 501349 / LM 501314	TRB			FORD	Explorer	Diferencial / Diferencial / Differential
				FORD	F 1000 (79...)	Eixo Dianteiro / Eje Delantero / Front Axle
				FORD	Ranger	Diferencial / Diferencial / Differential
				FORD	Sierra (L* XR3 * S)	Eixo Dianteiro / Eje Delantero / Front Axle
GENERAL MOTORS	Caravan * Opala	Diferencial / Diferencial / Differential				















Fersa*			Brand / Marca / Marca	Model / Modelo / Modelo	Application / Aplicação / Aplicaciones
LM 501349 / LM 501314	TRB		AGRALE	TX 1600 * TX 1200	Eixo Dianteiro / Eje Delantero / Front Axle
			CBT	2070 * 2080 * 2100 * 2105 (4x2) * 2400 * 2400 (4x4) * 2500 * 2600	
			MARCHESAN	Arado Fixo AF * Arado Fixo Canavieiro AFC * Arado Fixo Leve AFL	
LM 501349 / LM 501510	TRB		CBT	Tratores 1000 * 1000 (4x4) * 1020 * 1020 (4x4) * 1065 * 1065 (4x4) * 1090 * 1105	Eixo Dianteiro / Eje Delantero / Front Axle
LM 503349 A / LM 503310	TRB		MERCEDES BENZ	MB 180	Eixo Dianteiro / Eje Delantero / Front Axle Eixo Traseiro / Eje Trasero / Rear Axle
LM 506849 / LM 506810	TRB		DODGE	Ram 2500	Eixo Traseiro / Eje Trasero / Rear Axle
LM 603049 / LM 603011	TRB		DINA	761	Eixo Dianteiro / Eje Delantero / Front Axle
			FORD	Explorer	
		F 1000 (79...)			
		F 2000			
		F 4000			
		LAND ROVER	Defender 112		
			Defender 114		
		NISSAN	Frontier		
			Pathfinder		
			Pick Up 2200		
			Pick Up 2200 4 x 4		
			Pick Up 2500		
			Pick Up 2500 4 x 4		
			Pick Up 2700 4 x 4		
			Terrano		
		X-Terra			
		AGCO MAXION		Tratores MF 235 (4x4) Antigo * MF 235 Moderno* 250 * 265 * MF265 RD * 270 * 274 * 275 * 285 * 290 * MF 292 (4x4) * 295 * 296 * 299	
Tratores MF (50X * 55X * 65R * 65X * 85 * 85X * 95 * 95X)	Tomada de Potência / Toma de Potencia / Power Take-off				
Tratores MF (50X * 55X * 65R * 65X * 85 * 85X * 95 * 95X)	Acionador da Polia / Accionador de Polea / Drive Pulley				
CBT		Tratores 1000 * 1000 (4x4) * 1020 * 1020 (4x4) * 1065 * 1065 (4x4) * 1090 * 1105	Tomada de Potência / Toma de Potencia / Power Take-off		
		Tratores 8060 (4x2) * 8060 (4x4) * 8240 * 8240A * 8260 * 8440 * 8450	Eixo Dianteiro / Eje Delantero / Front Axle		
JOHN DEERE		Tratores 5403 * 5600 Aeroportuário * 5605 * 5705 * 6605 * 7500 Aeroportuário * 7505	Embreagem / Embrague / Clutch		
		Tratores 5403 * 5600 Aeroportuário * 5605 * 5705 * 6605 * 7500 Aeroportuário * 7505	Sistema Hidráulico / Sistema Hidráulico / Hydraulic System		
VALTRA - VALMET		Tratores 110 ID * 110ID II * 118 * 118 (4x4) * 128 * 128 (4x4)	Eixo Dianteiro / Eje Delantero / Front Axle		
LM 603049 / LM 603012	TRB		CHRYSLER	Cherokee * Gran Cherokee	Diferencial / Diferencial / Differential
			FORD	Dakota	
			GENERAL MOTORS	Ranger	
LM 67048 / LM 67010	TRB		CHRYSLER	1800	Eixo Dianteiro / Eje Delantero / Front Axle
				Dart	
				Gran Sedan	
				Le Baron	
				Magnum	
			FORD	Explorer	
				Ranger	
				Taurus	
				Windstar	



















Fersa®			Brand / Marca / Marca	Model / Modelo / Modelo	Application / Aplicação / Aplicaciones		
LM 67048 / LM 67010	TRB		GENERAL MOTORS	Caprice	Eixo Dianteiro / Eje Delantero / Front Axle		
				Caravan * Opala			
				S 10			
				S 10 * Blazer			
				Silverado			
			NISSAN	Ichivan			
		VOLKSWAGEN	Combi				
			Kombi				
			Panel				
			AGCO MAXION	Colheteira Combinada Automotriz 1170DS * 1175DS * 1630 Arroeira * 3640 Arroeira * 5650 * MF 220A * 220CBD * 220STD * MF 310CBD * 310STD * 210 * 210S * 220 * 310		Câmbio / Caja de Cambios / Gearbox	
				Tomada de Potência / Toma de Potencia / Power Take-off			
			JOHN DEERE	Plantadeiras PL 803 * PL805		Transmissão / Transmisión / Transmission	
Plantadeiras PL 9200 * PL 9209 * PL9211				Unidade de Adubo / Unidad de Fertilizante / Fertilizer Unit			
MARCHESAN	Arado de Aivecas Reversível AAR		Embreagem / Embrague / Clutch				
	Arado Fixo AF * Arado Fixo Canavieiro AFC * Arado Fixo Leve AFL		Eixo Traseiro / Eje Trasero / Rear Axle				
	Plantadeira Hidráulica Tatu PHT * PHT Suprema		Caixa de Redução / Caja de Reducción / Reduction Box				
	Roçadeira RC 2 4500 * Roçadeira de Arrasto RCA 3100 * RCA E 3400		Caixa de Distribuição / Caja de Distribución / Distribution Box				
LM 78349 / LM 78310 A	TRB		FORD	Belina * Belina II * Corcel * Corcel II	Eixo Dianteiro / Eje Delantero / Front Axle		
				Del Rey * Pampa			
				Scala			
			GENERAL MOTORS	Caravan * Opala		Câmbio / Caja de Cambios / Gearbox	
				S 10 * Blazer			
			VOLKSWAGEN	Apollo			
LM 806649 / LM 806610	TRB		MBB	Sprinter	Diferencial / Diferencial / Differential		
			MERCEDES BENZ	Sprinter 313 * 413			
M 12649 / M 12610	TRB		VOLKSWAGEN	D 1400 TD * Volksbus	Eixo Dianteiro / Eje Delantero / Front Axle		
				E 13 * E 21			
			DODGE	H100			
				Ram 1500			
				Ram Van * Wagon 1500			
			FORD	F 1000 (79...)			
			GENERAL MOTORS	A-C-D (10*14*15*20*40) * Bonanza * Veraneio * D1000			
				Blazer			
				C 1500			
				C 2500			
				Luv			
				S 10 * Blazer			
				Silverado			
			HYUNDAI	HR			
			MITSUBISHI	L 200			
				L 300			
			NISSAN	D21			
				Frontier			
TOYOTA	Hilux						
	FNH	Colheteiras 4040 * 5030 * 5050 * 8040 * 8055 * TC55 * TC57 * CA1530		Eixo Dianteiro / Eje Delantero / Front Axle			
		Todos / Todos / All					
	Tratores 4600 * 4610 * 4630 * 5600 * 5610 * 5630 * 6600 * 6610 * 6630 * 7610 * 7630 * 7810 * 7830 * 8030 * 8BR						
JOHN DEERE	Tratores 5403 * 5600 Aeroportuário * 5605 * 5705 * 6605 * 7500 Aeroportuário * 7505		Sistema Hidráulico / Sistema Hidráulico / Hydraulic System				

















Fersa*			Brand / Marca / Marca	Model / Modelo / Modelo	Application / Aplicação / Aplicaciones
M 802048 / M 802011	TRB		VOLKSWAGEN	7-100 * 8-120 * 8-140 (CE*CO) * 8-150 * 9-150 OD	Caixa de Mudanças / Caja de Cambios / Gearbox Eixo Traseiro / Eje Trasero / Rear Axle
			FORD	Cargo 1113 * 1114 * 1116 * 1117	Caixa de Mudanças / Caja de Cambios / Gearbox Eixo Traseiro / Eje Trasero / Rear Axle
				Cargo 1215	Caixa de Mudanças / Caja de Cambios / Gearbox Eixo Traseiro / Eje Trasero / Rear Axle
				Cargo 1313 * 1314 * 1317 * 1317E	Caixa de Mudanças / Caja de Cambios / Gearbox Eixo Traseiro / Eje Trasero / Rear Axle
				Cargo 1415 * 1416	Caixa de Mudanças / Caja de Cambios / Gearbox Eixo Traseiro / Eje Trasero / Rear Axle
				Cargo 1422 * 1514 * 1517 * 1517E * 1615 * 1615T * 1617 * 1618 * 1618T * 1619 * 1621 * 1622 * 1717E * 1722 * 1722E * 2216 * 2217 * 2218 * 2218T * 2319 * 2322 * 2324 * 2422 * 2422E * 2425 * 2428E * 2630 * 3224 * 3530 * 4030	Caixa de Mudanças / Caja de Cambios / Gearbox Eixo Traseiro / Eje Trasero / Rear Axle
				Cargo 814	Caixa de Mudanças / Caja de Cambios / Gearbox
				Cargo 815 * 815 E	Eixo Traseiro / Eje Trasero / Rear Axle
				F-450 * F-450 Super Duty	
				FL 60	
				FL 70	
				FS 65	
				6-100 (4X2)* 6-150* 12-170 L*S (4X2)* 14-190 (77...) (4X2)* 15-190 (77...) (4X2)* 16-220 (4X2)	Caixa de Mudanças / Caja de Cambios / Gearbox
				A-C-D 60* 70* 80* 90* 99 Turbo e 3500 Heavy Duty	
				C-3500	Eixo Traseiro / Eje Trasero / Rear Axle
		Kodiak			
		INTERNATIONAL	4200 VT 365 * 4300 DT 466 / 195 HP	Caixa de Mudanças / Caja de Cambios / Gearbox	
		VOLKSWAGEN	11-130 * 11-140 * 11-160	Eixo Traseiro / Eje Trasero / Rear Axle	
			12-140 * 12-140 H * 12-140 T * 12-170 BT		
			13-130 * 13-150 * 13-170 * 13-180E * 13-190 (77...)E * 13-210	Caixa de Mudanças / Caja de Cambios / Gearbox	
			6-80 * 6-90 * 6-90 (P*S)	Eixo Traseiro / Eje Trasero / Rear Axle	
			FORD	Explorer	
				F 1000 (79...)	Diferencial / Diferencial / Differential
				Ranger	
			GENERAL MOTORS	A-C-D (10*14*15*20*40) * Bonanza * Veraneio * D1000	Câmbio / Caja de Cambios / Gearbox
				Blazer * Gran Blazer	
				D 10	Diferencial / Diferencial / Differential
				D 20 (Bonanza * Veraneio)	
				S 10 * Blazer	
			Silverado	Câmbio / Caja de Cambios / Gearbox Diferencial / Diferencial / Differential	
				VALTRA - VALMET	Tratores 685 * 685C (4x4) * 785 * 785C (4x4) * 880 Cafeeiro * 880 (4x4) * 885 * 980 (4x4) * 985 * 985F * 1180 * 1184
			AGCO MAXION	Tratores MF 235 (4x4) Antigo * MF 235 Moderno* 250 * 265 * MF265 RD * 270 * 274 * 275 * 285 * 290 * MF 292 (4x4) * 295 * 296 * 299	Eixo Dianteiro / Eje Delantero / Front Axle
AGRALE	TX 1600 * TX 1200		Eixo Traseiro / Eje Trasero / Rear Axle		
CBT	2070 * 2080 * 2100 * 2105 (4x2) * 2400 * 2400 (4x4) * 2500 * 2600		Eixo Dianteiro / Eje Delantero / Front Axle Eixo Traseiro / Eje Trasero / Rear Axle		











Fersa®			Brand / Marca / Marca	Model / Modelo / Modelo	Application / Aplicação / Aplicaciones
M 802048 / M 802011	TRB		CBT	Tratores 1000 * 1000 (4x4) * 1020 * 1020 (4x4) * 1065 * 1065 (4x4) * 1090 * 1105	Eixo Dianteiro / Eje Delantero / Front Axle Eixo Traseiro / Eje Trasero / Rear Axle
			FNH	Tratores 4600 * 4610 * 4630 * 5600 * 5610 * 5630 * 6600 * 6610 * 6630 * 7610 * 7630 * 7810 * 7830 * 8030 * 8BR	Tração Dianteira / Tracción Delantero / Front Traction
			JOHN DEERE	Colheitadeiras CA9650 * CA9750 STS Tratores 5403 * 5600 Aeroportuário * 5605 * 5705 * 6605 * 7500 Aeroportuário * 7505	Eixo Traseiro / Eje Trasero / Rear Axle
			VALTRA - VALMET	Tratores 685 * 685C (4x4) * 785 * 785C (4x4) * 880 Cafeeiro * 880 (4x4) * 885 * 980 (4x4) * 985 * 985F * 1180 * 1184	Tração Dianteira / Tracción Delantero / Front Traction
M 804049 / M 804010	TRB		CHRYSLER	D-600 * PD-600 Ram 6500	Caixa de Mudanças / Caja de Cambios / Gearbox
			DINA	531 K * 532 J	
			FORD	F-600 * B-600	
			FREIGHTLINER	FL 60	Eixo Traseiro / Eje Trasero / Rear Axle
				FL 70	
			FS 65	Caixa de Mudanças / Caja de Cambios / Gearbox	
			GENERAL MOTORS		Kodiak
			INTERNATIONAL		4200 VT 365 * 4300 DT 466 / 195 HP
			MERCEDES BENZ		L1113 * L1114 * L1116 * L1117 * L1118
					L1313 * L1314 * L1315 * L1316 * L1317 * L1318 * L1319 * L1321
					L1417 52
					L1518 52
					L1617 59
					L2121 54
		LK1417 34			
		LK1418 39 * LK1418 52			
		LK1418 39 * LK1418 52			
		MBO 1017	Eixo Traseiro / Eje Trasero / Rear Axle		
		MBO 1018 44	Caixa de Mudanças / Caja de Cambios / Gearbox Eixo Traseiro / Eje Trasero / Rear Axle		
		MBO 1019 44 Boxer	Caixa de Mudanças / Caja de Cambios / Gearbox Eixo Traseiro / Eje Trasero / Rear Axle		
		MBO 1219 52 Boxer	Caixa de Mudanças / Caja de Cambios / Gearbox		
		OMC 1419 51			
		LK 1313 * LK 1314 * LK 1315 * LK 1316 * LK 1317 * LK 1318 * LK 1319 * LK 1320 * LK 1321			
		455 OF			
		541 * 542			
		555 OF			
		MBO 1018 44			
		MBO 1019 44 Boxer			
MBO 1219 52 Boxer					
OMC 1419 51					
M 84548 / M 84510	TRB		GENERAL MOTORS	Caravan * Opala Marajó (1.0 * 1.4 * 1.6)	Diferencial / Diferencial / Differential
M 86647 / M 86610	TRB		GENERAL MOTORS	Caravan * Opala	Diferencial / Diferencial / Differential
M 86649 / M 86610	TRB		GENERAL MOTORS	Silverado	Diferencial / Diferencial / Differential
			VOLKSWAGEN	Santana * Santana Quantum (1.6 * 1.8 * 2.0)	
M 88043 / M 88010	TRB		MERCEDES BENZ	Sprinter 313 * 413	Diferencial / Diferencial / Differential
M 88048 / M 88010	TRB		JOHN DEERE	Diversos	Eixo / Eje / Axle
			FORD	Explorer	Diferencial / Diferencial / Differential
		F 1000 (79...) Ranger			









Fersa®			Brand / Marca / Marca	Model / Modelo / Modelo	Application / Aplicação / Aplicaciones
M 88048 / M 88010	TRB		GENERAL MOTORS	Blazer * Gran Blazer	Diferencial / Diferencial / Differential
				Caravan * Opala	
				D 10	
				D 20 (Bonanza * Veraneio)	
N 207 / C3	CRB		VOLKSWAGEN	Kombi	Eixo Traseiro / Eje Trasero / Rear Axle
N 307 FM	CRB	References Fersa with Multiple Applications / Referências Fersa com Múltiplas Aplicações / Referencias Fersa con Múltiples Aplicaciones			
N 309 FM	CRB		MERCEDES BENZ	312 (L*LK*LP) 51...58	Eixo Traseiro / Eje Trasero / Rear Axle
NJ 205 / C3	CRB		ALFA ROMEO	Alfa 2300	Câmbio / Caja de Cambios / Gearbox
			LADA	Samara	Embreagem / Embrague / Clutch
NJ 206	CRB		ALFA ROMEO	Alfa 2300	Câmbio / Caja de Cambios / Gearbox
NJ 2206 FM	CRB		MERCEDES BENZ	608 (L*LO) * 708 (L*LO) * 809 (LO*OF) * 812 (LO*OF) * 814 LO * 817 O * 914 LO * 709 * 710 * 712 * 712 C * 811 * 911 L * 912 * 913 * 914 * 914 C * 917	Tomada de Potência / Toma de Potencia / Power Take-off
NJ 2211 FM	CRB		MERCEDES BENZ	1113 (LPO*OH) * 1114 LPO * 1115 L (OH) * 1118 LPO	Caixa de Mudanças / Caja de Cambios / Gearbox
				1313 OH * 1314 OH * 1315 OH * 1316 (OH*OHL) * 1316 G (OH*OHL) * 1317 OH * 1318 OH * 1319 OH * 1320 (OH*OHL)	
				1418 OH * 1419 OH * 1420 (OH*OHL) * 1421 OHL	
				1113 (L*LA*LAK*LAS*LK*LP*LS*LP) * 1114 * 1114 (L*LK*LP) * 1116 (L*LA*LAK*LAS*LB*LK*LS) * 1118 (L*LK*LP)	
				1113 OF * 1115 OF	
			MERCEDES BENZ	1313 (L*LA*LAK*LB*LK*LS) * 1314 (L*LA*LAK*LB*LK*LS) * 1316 (L*LA*LAK*LAS*LB*LK*LS) * 1317 (L*LA*LAK*LK*LS)* 1319 (L)	
				1313 OF * 1314 OF * 1315 OF * 1316 OF * 1317 OF * 1318 OF * 1319 OF * 1320 OF	
				1414 * 1414 (K*L*LA*LAK*LK) * 1418 * 1418 (E*K*R) * 1418 (L*LA*LAK*LK*R(LK)) * 1419 (L*LK*LS) * 1420 (L*LK*LS)	
				1417 OF * 1419 OF * 1421 OF	
				1421 OMC	
	MERCEDES BENZ	1113 OF * 1115 OF			
		1313 OF * 1314 OF * 1315 OF * 1316 OF * 1317 OF * 1318 OF * 1319 OF * 1320 OF			
		1417 OF * 1419 OF * 1421 OF			
		1421 OMC			
NJ 2309 F / C3	CRB		VOLVO	FH 12 * FH 16 N * NL 10 BR * N * NL 12 BR * N 10BR Mark II * NL 10BR 6x2 NH 12 * FM 12	Eixo Traseiro / Eje Trasero / Rear Axle
NJ 304 FM	CRB		MERCEDES BENZ	608 (L*LO) * 708 (L*LO) * 809 (LO*OF) * 812 (LO*OF) * 814 LO * 817 O * 914 LO * 709 * 710 * 712 * 712 C * 811 * 911 L * 912 * 913 * 914 * 914 C * 917	Tomada de Potência / Toma de Potencia / Power Take-off
NJ 304 FMN	CRB		MERCEDES BENZ	608 D * E (L*LO) * 708 D * E (L*LO) * 709 L * 710 L * 712 L	Tomada de Potência / Toma de Potencia / Power Take-off
			MERCEDES BENZ	312 (L*LK*LP) 51...58	
NJ 305 C3	TRB		MERCEDES BENZ	1517 OF * 1518 OF * 1520 OF	Motor / Motor / Engine
				1517 OH * 1518 OH * 1519 OH * 1520 OH * 1521 OH	
			MERCEDES BENZ	326 O	
				362 O	
				364 O	
				370 RS*RSD*RST* ST*U*UP (O) * 371 RS*RSD*RST* ST*U*UP (O)	
	MERCEDES BENZ	1513 (L*LA*LAK*LB*LG*LK*LS) * 1514 (L*LK*LS) * 1516 (L*LA*LAK*LB*LG*LK*LS) * 1517 (L*LK) * 1518 (L*LK*LS) * 1519 (L*LAK*LB*LG*LK*LS) * 1520 (L*LK*LP*LPK*LPS*LS) * 1521 L * 1524 e 1525 (L*LK*LS)			
		1517 OF * 1518 OF * 1520 OF			
		2213 (L*LB*LK*LS) * 2213 6X6 (LA) * 2214 * 2215 (L*LB*LK*LS) * 2216 (L*LA*LAK*LB*LG*LK*LS) * 2217 (L*LB*LK*LS) * 2219 (L*LA*LAK*LB*LG*LK*LS) * 2220 * 2222 * 2225 (L*LB*LK*LS)			
2629 LS					





Fersa®			Brand / Marca / Marca	Model / Modelo / Modelo	Application / Aplicação / Aplicaciones
NJ 305 FM / C3	CRB		MERCEDES BENZ	1517 OH * 1518 OH * 1519 OH * 1520 OH * 1521 OH	Motor / Motor / Engine
				321 H (O) * 321 HL (O) (58...71)	
				326 O	
				352 HL (O) (...74)	
				355 O	
				362 O	
		364 O			
			MERCEDES BENZ	1513 (L*LA*LAK*LB*LG*LK*LS) * 1514 (L*LK*LS) *	
				1516 (L*LA*LAK*LB*LG*LK*LS) * 1517 (L*LK) * 1518 (L*LK*LS) *	
				1519 (L*LAK*LB*LG*LK*LS) * 1520 (L*LK*LP*LPK*LPS*LS) *	
1521 L * 1524 e 1525 (L*LK*LS)					
1517 OF * 1518 OF * 1520 OF					
1819 (L*LAK*LB*LG*LK*LS) * 1820 LG					
1924 (LS) * 1924 A (LS) * 1929 (L*LK*LS) * 1930 (LS) *					
1932 (LS) * 1933 (LS) * 1934 (LS) * 1935 (L*LS) * 1938 * 1938 S *					
1938 (L*LS) * 1941 (L*LS) * 1944 S * 1945 (L*LS)					
2213 (L*LB*LK*LS) * 2213 6X6 (LA) * 2214 * 2215 (L*LB*LK*LS) *					
2216 (L*LA*LAK*LB*LG*LK*LS) * 2217 (L*LB*LK*LS) *					
2219 (L*LA*LAK*LB*LG*LK*LS) * 2220 * 2222 *					
2225 (L*LB*LK*LS)					
Axor 2625 * 2628 * 2629 (LK*LS) * 2631 (B*K*L) * 2632 *					
2635 (B*K*L) * 2635 (L*LK*LS) * 2635 * 2638 (L*LK*LS) *					
Axor 2640 * 2641 * 2643 * Axor 2644 * Actos 2646 * 2648 *					
2650 * 2651 * 2653 * 2654 (L*LK*LS) * 2657 * 2658 * 2644 *					
Atego 2628 (B*K) * 2625 * Axor 2826 * Axor 2828 * Axor 2831					
2629 LS					
2635 (L*LK*LS)					
	MERCEDES BENZ	1517 OF * 1518 OF * 1520 OF			
NJ 307 FM	CRB		FIAT	190 (77...)	Caixa de Mudanças / Caja de Cambios / Gearbox
NJ 309 FM	CRB		FNH	Colheitadeiras 4040 * 5030 * 5050 * 8040 * 8055 * TC55 * TC57 * CA1530	Câmbio / Caja de Cambios / Gearbox
NJ 309 C3	CRB		AGCO MAXION	Colheitadeira Combinada Automotriz 1170DS * 1175DS * 1630 Arroeira * 3640 Arroeira * 5650 * MF 220A * 220CBD * 220STD * MF 310CBD * 310STD * 210 * 210S * 220 * 310	Câmbio / Caja de Cambios / Gearbox
			AGRALE	Diversos	Motor / Motor / Engine
NJ 309 FM	CRB	References Fersa with Multiple Applications / Referências Fersa com Múltiplas Aplicações / Referencias Fersa con Multiples Aplicaciones			
NJ 309 FM / C3	CRB		AGCO MAXION	Colheitadeira Combinada Automotriz 1170DS * 1175DS * 1630 Arroeira * 3640 Arroeira * 5650 * MF 220A * 220CBD * 220STD * MF 310CBD * 310STD * 210 * 210S * 220 * 310	Câmbio / Caja de Cambios / Gearbox
			VALTRA - VALMET	Tratores 1280 * 1284 * 1580 * 1780 * 1780 (4x4) * 1380 * 1680 * 1880 * 118 * 128 * 138 * 148 * 148 (4x4)	
NU 1011 FM	CRB	References Fersa with Multiple Applications / Referências Fersa com Múltiplas Aplicações / Referencias Fersa con Multiples Aplicaciones			
NU 206 FM	CRB		VOLVO	N * NL 10 BR * N * NL 12 BR * N 10BR Mark II * NL 10BR 6x2	Motor / Motor / Engine
NU 208 FM	CRB		MERCEDES BENZ	608 D * E (L*LO) * 708 D * E (L*LO) * 709 L * 710 L * 712 L	Caixa de Mudanças / Caja de Cambios / Gearbox
			MERCEDES BENZ	608 (L*LO) * 708 (L*LO) * 809 (LO*OF) * 812 (LO*OF) * 814 LO * 817 O * 914 LO * 709 * 710 * 712 * 712 C * 811 * 911 L * 912 * 913 * 914 * 914 C * 917	
NU 209 FMN	CRB		MERCEDES BENZ	1113 (LPO*OH) * 1114 LPO * 1115 L (OH) * 1118 LPO	Caixa de Mudanças / Caja de Cambios / Gearbox
				1517 OH * 1518 OH * 1519 OH * 1520 OH * 1521 OH	
				321 H (O) * 321 HL (O) (58...71)	
				326 O	
				352 HL (O) (...74)	
				355 O	
		362 O			
		364 O			
			MERCEDES BENZ	1113 (L*LA*LAK*LAS*LK*LP*LS*LP) * 1114 * 1114 (L*LK*LP) *	
				1116 (L*LA*LAK*LAS*LB* LK*LS) * 1118 (L*LK*LP)	
1113 OF * 1115 OF					
1513 (L*LA*LAK*LB*LG*LK*LS) * 1514 (L*LK*LS) *					
1516 (L*LA*LAK*LB*LG*LK*LS) * 1517 (L*LK) * 1518 (L*LK*LS) *					
1519 (L*LAK*LB*LG*LK*LS) * 1520 (L*LK*LP*LPK*LPS*LS) *					
1521 L * 1524 e 1525 (L*LK*LS)					
1517 OF * 1518 OF * 1520 OF					





Fersa®			Brand / Marca / Marca	Model / Modelo / Modelo	Application / Aplicação / Aplicaciones
NU 209 FMN	CRB		MERCEDES BENZ	1614 * 1615 (L*LK*LS) * 1615 * 1618 M * 1618 (L*LK*LS) * 1619 (L)	Caixa de Mudanças / Caja de Cambios / Gearbox
				1618 OF	
				2013 (L*LA*LAK*LB*LG*LK*LS) * 2013 6X2 (L) * 2014 (L*LB*LK) * 2016 (LB*LK) * 2017 (L*LB*LK)	
				2213 (L*LB*LK*LS) * 2213 6X6 (LA) * 2214 * 2215 (L*LB*LK*LS) * 2216 (L*LA*LAK*LB*LG*LK*LS) * 2217 (L*LB*LK*LS) * 2219 (L*LA*LAK*LB*LG*LK*LS) * 2220 * 2222 * 2225 (L*LB*LK*LS)	
			MERCEDES BENZ	312 (L*LK*LP) 51...58	Eixo Traseiro / Eje Trasero / Rear Axle
				321 LAP * LAPK * LAPS * LP * LPK * LPS	
				1113 OF * 1115 OF	
				1517 OF * 1518 OF * 1520 OF	
1618 OF	Caixa de Mudanças / Caja de Cambios / Gearbox				
NU 209 FMN / C3	CRB	References Fersa with Multiple Applications / Referências Fersa com Múltiplas Aplicações / Referencias Fersa con Multiples Aplicaciones			
NU 2205	CRB		RENAULT	Traffic (2.1 * 2.2 * 2.5)	Caixa de Mudanças / Caja de Cambios / Gearbox
NU 303 FM	CRB		MERCEDES BENZ	1517 OH * 1518 OH * 1519 OH * 1520 OH * 1521 OH	Motor / Motor / Engine
				321 H (O) * 321 HL (O) (58...71)	
				326 O	
				352 HL (O) (...74)	
				355 O	
				362 O	
		364 O			
			MERCEDES BENZ	1513 (L*LA*LAK*LB*LG*LK*LS) * 1514 (L*LK*LS) * 1516 (L*LA*LAK*LB*LG*LK*LS) * 1517 (L*LK) * 1518 (L*LK*LS) * 1519 (L*LAK*LB*LG*LK*LS) * 1520 (L*LK*LP*LPK*LPS*LS) * 1521 L * 1524 e 1525 (L*LK*LS)	
				1517 OF * 1518 OF * 1520 OF	
				1819 (L*LAK*LB*LG*LK*LS) * 1820 LG	
1924 (LS) * 1924 A (LS) * 1929 (L*LK*LS) * 1930 (LS) * 1932 (LS) * 1933 (LS) * 1934 (LS) * 1935 (L*LS) * 1938 * 1938 S * 1938 (L*LS) * 1941 (L*LS) * 1944 S * 1945 (L*LS)					
	MERCEDES BENZ	2213 (L*LB*LK*LS) * 2213 6X6 (LA) * 2214 * 2215 (L*LB*LK*LS) * 2216 (L*LA*LAK*LB*LG*LK*LS) * 2217 (L*LB*LK*LS) * 2219 (L*LA*LAK*LB*LG*LK*LS) * 2220 * 2222 * 2225 (L*LB*LK*LS)			
		2629 LS			
2635 (L*LK*LS)	1517 OF * 1518 OF * 1520 OF				
NU 303 FM / C3	CRB		MERCEDES BENZ	Axor 2625 * 2628 * 2629 (LK*LS) * 2631 (B*K*L) * 2632 * 2635 (B*K*L) * 2635 (L*LK*LS) * 2635 * 2638 (L*LK*LS) * Axor 2640 * 2641 * 2643 * Axor 2644 * Actos 2646 * 2648 * 2650 * 2651 * 2653 * 2654 (L*LK*LS) * 2657 * 2658 * 2644 * Atego 2628 (B*K) * 2625 * Axor 2826 * Axor 2828 * Axor 2831	Motor / Motor / Engine
NU 303 FMN	CRB		MERCEDES BENZ	370 RS*RSD*RST* ST*U*UP (O) * 371 RS*RSD*RST* ST*U*UP (O)	Motor / Motor / Engine
NU 310 C3	ELIMINAR				
NU 310 FM	CRB	References Fersa with Multiple Applications / Referências Fersa com Múltiplas Aplicações / Referencias Fersa con Multiples Aplicaciones			
NU 310 FM / C3	CRB		VALTRA - VALMET	Tratores 60 * 60 ID * 62 * 65 * 65 Cafeeiro * 68 * 68 Cafeeiro * 78 * 80 * M80 * 85 * 85ID * 86 * 86 ID * 88 * 88 ID	Câmbio / Caja de Cambios / Gearbox
				Tratores 110 ID * 110ID II * 118 * 118 (4x4) * 128 * 128 (4x4)	Eixo Traseiro / Eje Trasero / Rear Axle
NUP 206 FM	CRB		MERCEDES BENZ	1517 OH * 1518 OH * 1519 OH * 1520 OH * 1521 OH	Motor / Motor / Engine
			MERCEDES BENZ	1513 (L*LA*LAK*LB*LG*LK*LS) * 1514 (L*LK*LS) * 1516 (L*LA*LAK*LB*LG*LK*LS) * 1517 (L*LK) * 1518 (L*LK*LS) * 1519 (L*LAK*LB*LG*LK*LS) * 1520 (L*LK*LP*LPK*LPS*LS) * 1521 L * 1524 e 1525 (L*LK*LS)	
			MERCEDES BENZ	1517 OF * 1518 OF * 1520 OF	
NUP 212 FM	CRB		MERCEDES BENZ	331 (L*LPK*LPS) 60...68	Caixa de Mudanças / Caja de Cambios / Gearbox
NUP 2205	CRB		ALFA ROMEO	Alfa 2300	Câmbio / Caja de Cambios / Gearbox
NUP 2212 F	CRB		VOLVO	B 58	Eixo Traseiro / Eje Trasero / Rear Axle
			VOLVO	B 58 BR (...Chassi 304120) N * NL 10 BR * N * NL 12 BR * N 10BR Mark II * NL 10BR 6x2	









Fersa®			Brand / Marca / Marca	Model / Modelo / Modelo	Application / Aplicação / Aplicaciones							
NUP 2212 FMN	CRB		MERCEDES BENZ	1418 OH * 1419 OH * 1420 (OH*OHL) * 1421 OHL 1721 L (OH)	Caixa de Mudanças / Caja de Cambios / Gearbox							
			MERCEDES BENZ	1214 C * 1214 K * 1214 (L*LK*LS) * 1215 * 1215 C * 1215 (L*LA*LK) * 1218 * 1218 R (L) 1215 OF * 1217 OF 1414 * 1414 (K*L*LA*LAK*LK) * 1418 * 1418 (E*K*R) * 1418 (L*LA*LAK*LK*R(LK)) * 1419 (L*LK*LS) * 1420 (L*LK*LS) 1417 OF * 1419 OF * 1421 OF 1421 OMC 1614 * 1615 (L*LK*LS) * 1615 * 1618 M * 1618 (L*LK*LS) * 1619 (L) 1618 OF 1714 OF * 1721 OF * 1722 OF 1714 * 1714 (L*K*LK) * 1715 * 1718 * 1718 (A * AK) * K * 1720 L * 1721 * 1721 S * 1721 (L*LK) * 1722 S * 1723 * 1723 S * 1725 L								
						MERCEDES BENZ	1215 OF * 1217 OF 1417 OF * 1419 OF * 1421 OF 1421 OMC 1618 OF 1714 OF * 1721 OF * 1722 OF					
							References Fersa with Multiple Applications / Referências Fersa com Múltiplas Aplicações / Referencias Fersa con Multiples Aplicaciones					
							NUP 304 FM	CRB		MERCEDES BENZ	370 RS*RSD*RST* ST*U*UP (O) * 371 RS*RSD*RST* ST*U*UP (O)	Motor / Motor / Engine
							NUP 308 FM	CRB		FIAT	190 (77...)	Caixa de Mudanças / Caja de Cambios / Gearbox
				NUP 309 C3		CRB		AGRALE	Diversos	Motor / Motor / Engine		
				NUP 309 FM		CRB		VALTRA - VALMET	Tratores 1280 * 1284 * 1580 * 1780 * 1780 (4x4) * 1380 * 1680 * 1880 * 118 * 128 * 138 * 148 * 148 (4x4)	Câmbio / Caja de Cambios / Gearbox Tomada de Potência / Toma de Potencia / Power Take-off		
									References Fersa with Multiple Applications / Referências Fersa com Múltiplas Aplicações / Referencias Fersa con Multiples Aplicaciones			
				NUP 309 FM / C3		CRB		VOLVO	B 10M BR B 10R * B 12B * B 12R * B 58 * B 58BR * B 7R * B9 B 58 B 58 BR (...Chassi 304120)	Eixo Traseiro / Eje Trasero / Rear Axle		
									References Fersa with Multiple Applications / Referências Fersa com Múltiplas Aplicações / Referencias Fersa con Multiples Aplicaciones			
		NUP 310 FM / C3	CRB						References Fersa with Multiple Applications / Referências Fersa com Múltiplas Aplicações / Referencias Fersa con Multiples Aplicaciones			
		NUP 310 FMN / C3	CRB							MERCEDES BENZ	1418 OH * 1419 OH * 1420 (OH*OHL) * 1421 OHL 1721 L (OH)	Caixa de Mudanças / Caja de Cambios / Gearbox
						MERCEDES BENZ	1214 C * 1214 K * 1214 (L*LK*LS) * 1215 * 1215 C * 1215 (L*LA*LK) * 1218 * 1218 R (L) 1215 OF * 1217 OF 1414 * 1414 (K*L*LA*LAK*LK) * 1418 * 1418 (E*K*R) * 1418 (L*LA*LAK*LK*R(LK)) * 1419 (L*LK*LS) * 1420 (L*LK*LS) 1417 OF * 1419 OF * 1421 OF 1421 OMC 1614 * 1615 (L*LK*LS) * 1615 * 1618 M * 1618 (L*LK*LS) * 1619 (L) 1618 OF 1714 OF * 1721 OF * 1722 OF 1714 * 1714 (L*K*LK) * 1715 * 1718 * 1718 (A * AK) * K * 1720 L * 1721 * 1721 S * 1721 (L*LK) * 1722 S * 1723 * 1723 S * 1725 L					
								MERCEDES BENZ	1215 OF * 1217 OF 1417 OF * 1419 OF * 1421 OF 1421 OMC 1618 OF 1714 OF * 1721 OF * 1722 OF			
References Fersa with Multiple Applications / Referências Fersa com Múltiplas Aplicações / Referencias Fersa con Multiples Aplicaciones												
NUP 311 FM	CRB								MERCEDES BENZ	331 (L*LPK*LPS) 60...68	Caixa de Mudanças / Caja de Cambios / Gearbox	
NUP 311 FM / C3	CRB								MERCEDES BENZ	2213 (L*LB*LK*LS) * 2213 6X6 (LA) * 2214 * 2215 (L*LB*LK*LS) * 2216 (L*LA*LAK*LB*LG*LK*LS) * 2217 (L*LB*LK*LS) * 2219 (L*LA*LAK*LB*LG*LK*LS) * 2220 * 2222 * 2225 (L*LB*LK*LS)	Caixa de Mudanças / Caja de Cambios / Gearbox	
							NUP 311 FMNR / C3	CRB			MERCEDES BENZ	
	MERCEDES BENZ				1614 * 1615 (L*LK*LS) * 1615 * 1618 M * 1618 (L*LK*LS) * 1619 (L)							

Fersa®			Brand / Marca / Marca	Model / Modelo / Modelo	Application / Aplicação / Aplicaciones			
NUP 311 FMNR / C3	CRB		MERCEDES BENZ	1618 OF	Caixa de Mudanças / Caja de Cambios / Gearbox			
				1620(L*LK*LS) * 1620 6X2 51 (L) * 1621 (L*LK*LS) * 1622(L*LK*LS) * 1623 (L*LS) * 1625(L*LK*LS) * 1630 (L*LK*LS) * 1632 (L*LS) * 1633(L*LK*LS) * 1634 (L*LS) * 1635 L				
				1620 OF * 1621 OF				
				1714 OF * 1721 OF * 1722 OF				
				1714 * 1714 (L*K*LK) * 1715 * 1718 * 1718 (A * AK) * K * 1720 L * 1721 * 1721 S * 1721 (L*LK) * 1722 S * 1723 * 1723 S * 1725 L				
				1924 (LS) * 1924 A (LS) * 1929 (L*LK*LS) * 1930 (LS) * 1932 (LS) * 1933 (LS) * 1934 (LS) * 1935 (L*LS) * 1938 * 1938 S * 1938 (L*LS) * 1941 (L*LS) * 1944 S * 1945 (L*LS)				
				2314 (L*LB*LK*LS) * 2318 (L*LB*LK*LS) * 2325 (L*LB*LK*LS)				
				2414 (6X4) * 2414 (L) * 2418 (L*LB*LK) * 2420 (L*LB*LK) * 2423 B 6X4 * 2423 K 6X4 * 2425 6X6 (LA) * 2425 (L*LB*LK) * 2428 6X4 2629 LS		Eixo Traseiro / Eje Trasero / Rear Axle		
						MERCEDES BENZ	1618 OF	Caixa de Mudanças / Caja de Cambios / Gearbox
							1620 OF * 1621 OF	
1714 OF * 1721 OF * 1722 OF								
NUP 314 FM	CRB		MERCEDES BENZ	1517 OH * 1518 OH * 1519 OH * 1520 OH * 1521 OH	Caixa de Mudanças / Caja de Cambios / Gearbox			
				1513 (L*LA*LAK*LB*LG*LK*LS) * 1514 (L*LK*LS) * 1516 (L*LA*LAK*LB*LG*LK*LS) * 1517 (L*LK) * 1518 (L*LK*LS) * 1519 (L*LAK*LB*LG*LK*LS) * 1520 (L*LK*LP*LPK*LPS*LS) * 1521 L * 1524 & 1525 (L*LK*LS)				
				1517 OF * 1518 OF * 1520 OF				
NUP 314 FM / C3	CRB		MERCEDES BENZ	1517 OH * 1518 OH * 1519 OH * 1520 OH * 1521 OH	Caixa de Mudanças / Caja de Cambios / Gearbox			
				400 (R * RS * RSD * RSL) (O)				
				500 (O*M*R)				
				1513 (L*LA*LAK*LB*LG*LK*LS) * 1514 (L*LK*LS) * 1516 (L*LA*LAK*LB*LG*LK*LS) * 1517 (L*LK) * 1518 (L*LK*LS) * 1519 (L*LAK*LB*LG*LK*LS) * 1520 (L*LK*LP*LPK*LPS*LS) * 1521 L * 1524 e 1525 (L*LK*LS)				
				1517 OF * 1518 OF * 1520 OF				
				1614 * 1615 (L*LK*LS) * 1615 * 1618 M * 1618 (L*LK*LS) * 1619 (L)				
				1618 OF				
				1819 (L*LAK*LB*LG*LK*LS) * 1820 LG				
				1924 (LS) * 1924 A (LS) * 1929 (L*LK*LS) * 1930 (LS) * 1932 (LS) * 1933 (LS) * 1934 (LS) * 1935 (L*LS) * 1938 * 1938 S * 1938 (L*LS) * 1941 (L*LS) * 1944 S * 1945 (L*LS)				
				2213 (L*LB*LK*LS) * 2213 6X6 (LA) * 2214 * 2215 (L*LB*LK*LS) * 2216 (L*LA*LAK*LB*LG*LK*LS) * 2217 (L*LB*LK*LS) * 2219 (L*LA*LAK*LB*LG*LK*LS) * 2220 * 2222 * 2225 (L*LB*LK*LS)				
	MERCEDES BENZ	1517 OF * 1518 OF * 1520 OF	Caixa de Mudanças / Caja de Cambios / Gearbox					
		1618 OF						
NUP 314 FMN / C3	CRB		VOLVO	B 10M BR B 58 BR (...Chassi 304120)	Caixa de Mudanças / Caja de Cambios / Gearbox			
NUP 314 FMNR	CRB		FIAT	FNM 210 C * CM * LN (71...76)	Caixa de Mudanças / Caja de Cambios / Gearbox			
NUP 314 FMNR / C3	CRB		MERCEDES BENZ	MAN	Caixa de Mudanças / Caja de Cambios / Gearbox			
				MASA				
				1517 OH * 1518 OH * 1519 OH * 1520 OH * 1521 OH				
				1621 L (OH) * 1623 LG (OH) * 1625 (OH) * 1625 L (OH) * 1628 L (OH) * 1630L (OH) * 1635 (OH) * 1636 L (OH)				
				1721 L (OH)				
				400 (R * RS * RSD * RSL) (O)				
				Multigo IBC 1842 * IBC 2242 * OC 500				
				O 371 R * O 371 RS * O 371 RSD				
				O 400 R * O 400 RS * O 400 RSD * O 400 RSE * O 400 RSL * MP 105 * MP 108 DD * MP120 * MP 180 DD				
				FIAT				
	MERCEDES BENZ	1513 (L*LA*LAK*LB*LG*LK*LS) * 1514 (L*LK*LS) * 1516 (L*LA*LAK*LB*LG*LK*LS) * 1517 (L*LK) * 1518 (L*LK*LS) * 1519 (L*LAK*LB*LG*LK*LS) * 1520 (L*LK*LP*LPK*LPS*LS) * 1521 L * 1524 e 1525 (L*LK*LS)	Caixa de Mudanças / Caja de Cambios / Gearbox					
		1517 OF * 1518 OF * 1520 OF						
		1614 * 1615 (L*LK*LS) * 1615 * 1618 M * 1618 (L*LK*LS) * 1619 (L)						

Fersa®			Brand / Marca / Marca	Model / Modelo / Modelo	Application / Aplicação / Aplicaciones
NUP 314 FMNR / C3	CRB		MERCEDES BENZ	1618 OF	Caixa de Mudanças / Caja de Cambios / Gearbox
				1620(L*LK*LS) * 1620 6X2 51 (L) * 1621 (L*LK*LS) * 1622(L*LK*LS) * 1623 (L*LS) * 1625(L*LK*LS) * 1630 (L*LK*LS) * 1632 (L*LS) * 1633(L*LK*LS) * 1634 (L*LS) * 1635 L	
				1620 OF * 1621 OF	
				1714 OF * 1721 OF * 1722 OF	
				1714 * 1714 (L*K*LK) * 1715 * 1718 * 1718 (A * AK) * K * 1720 L * 1721 * 1721 S * 1721 (L*LK) * 1722 S * 1723 * 1723 S * 1725 L	
		1819 (L*LAK*LB*LG*LK*LS) * 1820 LG			
		L1924 * L1929 * L1930 * L1932 * L1933 * L1934 * L1935 * L1937 * L1938 * L1939 * L1941 * L1942 * L1944 * L1945 * L1951			
		1517 OF * 1518 OF * 1520 OF			
		1618 OF			
		1620 OF * 1621 OF			
1714 OF * 1721 OF * 1722 OF					
QJ 208 FM	BB4PAC		MERCEDES BENZ	608 D * E (L*LO) * 708 D * E (L*LO) * 709 L * 710 L * 712 L	Caixa de Mudanças / Caja de Cambios / Gearbox
			MERCEDES BENZ	608 (L*LO) * 708 (L*LO) * 809 (LO*OF) * 812 (LO*OF) * 814 LO * 817 O * 914 LO * 709 * 710 * 712 * 712 C * 811 * 911 L * 912 * 913 * 914 * 914 C * 917	
QJ 209 FM	BB4PAC		MERCEDES BENZ	1018 MBO	Caixa de Mudanças / Caja de Cambios / Gearbox
				1113 OF * 1115 OF	
				1517 OF * 1518 OF * 1520 OF	
				1113 (LPO*OH) * 1114 LPO * 1115 L (OH) * 1118 LPO	
				1517 OH * 1518 OH * 1519 OH * 1520 OH * 1521 OH	
		321 H (O) * 321 HL (O) (58...71)			
		326 O			
		352 HL (O) (...74)			
		355 O			
		362 O			
364 O					
			MERCEDES BENZ	1018 MBO	Caixa de Mudanças / Caja de Cambios / Gearbox
				1111 (L*LA*LAK* LAS*LK*LS)	
				1113 (L*LA*LAK*LAS*LK*LP*LS*LP) * 1114 * 1114 (L*LK*LP) * 1116 (L*LA*LAK*LAS*LB* LK*LS) * 1118 (L*LK*LP)	
				1113 OF * 1115 OF	
				1513 (L*LA*LAK*LB*LG*LK*LS) * 1514 (L*LK*LS) * 1516 (L*LA*LAK*LB*LG*LK*LS) * 1517 (L*LK) * 1518 (L*LK*LS) * 1519 (L*LAK*LB*LG*LK*LS) * 1520 (L*LK*LP*LPK*LPS*LS) * 1521 L * 1524 e 1525 (L*LK*LS)	
		1517 OF * 1518 OF * 1520 OF			
		2013 (L*LA*LAK*LB*LG*LK*LS) * 2013 6X2 (L) * 2014 (L*LB*LK) * 2016 (LB*LK) * 2017 (L*LB*LK)			
		2213 (L*LB*LK*LS) * 2213 6X6 (LA) * 2214 * 2215 (L*LB*LK*LS) * 2216 (L*LA*LAK*LB*LG*LK*LS) * 2217 (L*LB*LK*LS) * 2219 (L*LA*LAK*LB*LG*LK*LS) * 2220 * 2222 * 2225 (L*LB*LK*LS)			
		312 (L*LK*LP) 51...58			
		321 LAP * LAPK * LAPS * LP * LPK * LPS			
321 (LAP*LAPK*LAPS*LP* LPK*LPS) 51...71					
References Fersa with Multiple Applications / Referências Fersa com Múltiplas Aplicações / Referencias Fersa con Multiples Aplicaciones					
QJ 212 FM	BB4PAC		MERCEDES BENZ	1113 OF * 1115 OF	Caixa de Mudanças / Caja de Cambios / Gearbox
				1215 OF * 1217 OF	
				1313 OF * 1314 OF * 1315 OF * 1316 OF * 1317 OF * 1318 OF * 1319 OF * 1320 OF	
				1417 OF * 1419 OF * 1421 OF	
				1421 OMC	
				1517 OF * 1518 OF * 1520 OF	
				1618 OF	
				1620 OF * 1621 OF	
				1714 OF * 1721 OF * 1722 OF	

Fersa*			Brand / Marca / Marca	Model / Modelo / Modelo	Application / Aplicação / Aplicaciones					
QJ 212 FM	BB4PAC		MERCEDES BENZ	1113 (LPO*OH) * 1114 LPO * 1115 L (OH) * 1118 LPO						
				1313 OH * 1314 OH * 1315 OH * 1316 (OH*OHL) * 1316 G (OH*OHL) * 1317 OH * 1318 OH * 1319 OH * 1320 (OH*OHL)						
				1418 OH * 1419 OH * 1420 (OH*OHL) * 1421 OHL						
				1517 OH * 1518 OH * 1519 OH * 1520 OH * 1521 OH						
				1621 L (OH) * 1623 LG (OH) * 1625 (OH) * 1625 L (OH) * 1628 L (OH) * 1630L (OH) * 1635 (OH) * 1636 L (OH)						
				1721 L (OH)						
				321 H (O) * 321 HL (O) (58...71)						
				326 O						
				352 HL (O) (...74)						
				355 O						
				362 O						
				364 O						
				370 RS*RSD*RST* ST*U*UP (O) * 371 RS*RSD*RST* ST*U*UP (O)						
				608 D * E (L*LO) * 708 D * E (L*LO) * 709 L * 710 L * 712 L						
						MERCEDES BENZ	1113 (L*LA*LAK*LAS*LK*LP*LS*LP) * 1114 * 1114 (L*LK*LP) * 1116 (L*LA*LAK*LAS*LB* LK*LS) * 1118 (L*LK*LP)	Caixa de Mudanças / Caja de Cambios / Gearbox		
		1113 OF * 1115 OF								
		1214 C * 1214 K * 1214 (L*LK*LS) * 1215 * 1215 C * 1215 (L*LA*LK) * 1218 * 1218 R (L)								
		1215 OF * 1217 OF								
		1313 (L*LA*LAK*LB*LK*LS) * 1314 (L*LA*LAK*LB*LK*LS) * 1316 (L*LA*LAK*LAS*LB*LK*LS) * 1317 (L*LA*LAK*LK*LS)* 1319 (L)								
		1313 OF * 1314 OF * 1315 OF * 1316 OF * 1317 OF * 1318 OF * 1319 OF * 1320 OF								
		1414 * 1414 (K*L*LA*LAK*LK) * 1418 * 1418 (E*K*R) * 1418 (L*LA*LAK*LK*R(LK)) * 1419 (L*LK*LS) * 1420 (L*LK*LS)								
		1417 OF * 1419 OF * 1421 OF								
		1421 OMC								
		1513 (L*LA*LAK*LB*LG*LK*LS) * 1514 (L*LK*LS) * 1516 (L*LA*LAK*LB*LG*LK*LS) * 1517 (L*LK) * 1518 (L*LK*LS) * 1519 (L*LAK*LB*LG*LK*LS) * 1520 (L*LK*LP*LPK*LPS*LS) * 1521 L * 1524 e 1525 (L*LK*LS)								
		1517 OF * 1518 OF * 1520 OF								
		1614 * 1615 (L*LK*LS) * 1615 * 1618 M * 1618 (L*LK*LS) * 1619 (L)								
		1618 OF								
		1620 OF * 1621 OF								
		1620(L*LK*LS) * 1620 6X2 51 (L) * 1621 (L*LK*LS) * 1622(L*LK*LS) * 1623 (L*LS) * 1625(L*LK*LS) * 1630 (L*LK*LS) * 1632 (L*LS) * 1633(L*LK*LS) * 1634 (L*LS) * 1635 L								
		1714 * 1714 (L*K*LK) * 1715 * 1718 * 1718 (A * AK) * K * 1720 L * 1721 * 1721 S * 1721 (L*LK) * 1722 S * 1723 * 1723 S * 1725 L								
		1714 OF * 1721 OF * 1722 OF								
		2013 (L*LA*LAK*LB*LG*LK*LS) * 2013 6X2 (L) * 2014 (L*LB*LK) * 2016 (LB*LK) * 2017 (L*LB*LK)								
		2213 (L*LB*LK*LS) * 2213 6X6 (LA) * 2214 * 2215 (L*LB*LK*LS) * 2216 (L*LA*LAK*LB*LG*LK*LS) * 2217 (L*LB*LK*LS) * 2219 (L*LA*LAK*LB*LG*LK*LS) * 2220 * 2222 * 2225 (L*LB*LK*LS)								
		2314 (L*LB*LK*LS) * 2318 (L*LB*LK*LS) * 2325 (L*LB*LK*LS)								
		2414 (6X4) * 2414 (L) * 2418 (L*LB*LK) * 2420 (L*LB*LK) * 2423 B 6X4 * 2423 K 6X4 * 2425 6X6 (LA) * 2425 (L*LB*LK) * 2428 6X4	Eixo Traseiro / Eje Trasero / Rear Axle							
		608 (L*LO) * 708 (L*LO) * 809 (LO*OF) * 812 (LO*OF) * 814 LO * 817 O * 914 LO * 709 * 710 * 712 * 712 C * 811 * 911 L * 912 * 913 * 914 * 914 C * 917	Caixa de Mudanças / Caja de Cambios / Gearbox							
		QJ 309 FM	BB4PAC				MERCEDES BENZ		1018 MBO	Caixa de Mudanças / Caja de Cambios / Gearbox
									1113 OF * 1115 OF	
									1215 OF * 1217 OF	
									1313 OF * 1314 OF * 1315 OF * 1316 OF * 1317 OF * 1318 OF * 1319 OF * 1320 OF	
									1417 OF * 1419 OF * 1421 OF	
									1421 OMC	
									1517 OF * 1518 OF * 1520 OF	
									1618 OF	
									1620 OF * 1621 OF	
									1714 OF * 1721 OF * 1722 OF	

Fersa®			Brand / Marca / Marca	Model / Modelo / Modelo	Application / Aplicação / Aplicaciones
QJ 309 FM	BB4PAC		MERCEDES BENZ	1113 (LPO*OH) * 1114 LPO * 1115 L (OH) * 1118 LPO 1313 OH * 1314 OH * 1315 OH * 1316 (OH*OHL) * 1316 G (OH*OHL) * 1317 OH * 1318 OH * 1319 OH * 1320 (OH*OHL) 1418 OH * 1419 OH * 1420 (OH*OHL) * 1421 OHL 1517 OH * 1518 OH * 1519 OH * 1520 OH * 1521 OH 1621 L (OH) * 1623 LG (OH) * 1625 (OH) * 1625 L (OH) * 1628 L (OH) * 1630L (OH) * 1635 (OH) * 1636 L (OH) 1714 OF * 1721 OF * 1722 OF 1721 L (OH) 321 H (O) * 321 HL (O) (58...71) 326 O 352 HL (O) (...74) 355 HL (O) (...74) 355 O 362 O 364 O 370 RS*RSD*RST* ST*U*UP (O) * 371 RS*RSD*RST* ST*U*UP (O) 608 D * E (L*LO) * 708 D * E (L*LO) * 709 L * 710 L * 712 L 812 LO * 912 L	
			MERCEDES BENZ	1018 MBO 1111 (L*LA*LAK* LAS*LK*LS) 1214 C * 1214 K * 1214 (L*LK*LS) * 1215 * 1215 C * 1215 (L*LA*LK) * 1218 * 1218 R (L) 1215 OF * 1217 OF 1513 (L*LA*LAK*LB*LG*LK*LS) * 1514 (L*LK*LS) * 1516 (L*LA*LAK*LB*LG*LK*LS) * 1517 (L*LK) * 1518 (L*LK*LS) * 1519 (L*LAK*LB*LG*LK*LS) * 1520 (L*LK*LP*LPK*LPS*LS) * 1521 L * 1524 e 1525 (L*LK*LS) 1517 OF * 1518 OF * 1520 OF 1614 * 1615 (L*LK*LS) * 1615 * 1618 M * 1618 (L*LK*LS) * 1619 (L) 1618 OF 1620(L*LK*LS) * 1620 6X2 51 (L) * 1621 (L*LK*LS) * 1622(L*LK*LS) * 1623 (L*LS) * 1625(L*LK*LS) * 1630 (L*LK*LS) * 1632 (L*LS) * 1633(L*LK*LS) * 1634 (L*LS) * 1635 L 1620 OF * 1621 OF 1714 OF * 1721 OF * 1722 OF 1714 * 1714 (L*K*LK) * 1715 * 1718 * 1718 (A * AK) * K * 1720 L * 1721 * 1721 S * 1721 (L*LK) * 1722 S * 1723 * 1723 S * 1725 L 2013 (L*LA*LAK*LB*LG*LK*LS) * 2013 6X2 (L) * 2014 (L*LB*LK) * 2016 (LB*LK) * 2017 (L*LB*LK) 2213 (L*LB*LK*LS) * 2213 6X6 (LA) * 2214 * 2215 (L*LB*LK*LS) * 2216 (L*LA*LAK*LB*LG*LK*LS) * 2217 (L*LB*LK*LS) * 2219 (L*LA*LAK*LB*LG*LK*LS) * 2220 * 2222 * 2225 (L*LB*LK*LS) 2314 (L*LB*LK*LS) * 2318 (L*LB*LK*LS) * 2325 (L*LB*LK*LS) 321 (LAP*LAPK*LAPS*LP* LPK*LPS) 51...71 608 (L*LO) * 708 (L*LO) * 809 (LO*OF) * 812 (LO*OF) * 814 LO * 817 O * 914 LO * 709 * 710 * 712 * 712 C * 811 * 911 L * 912 * 913 * 914 * 914 C * 917 1113 (L*LA*LAK*LAS*LK*LP*LS*LP) * 1114 * 1114 (L*LK*LP) * 1116 (L*LA*LAK*LAS*LB* LK*LS) * 1118 (L*LK*LP) 1113 OF * 1115 OF 1313 (L*LA*LAK*LB*LK*LS) * 1314 (L*LA*LAK*LB*LK*LS) * 1316 (L*LA*LAK*LAS*LB*LK*LS) * 1317 (L*LA*LAK*LK*LS)* 1319 (L) 1313 OF * 1314 OF * 1315 OF * 1316 OF * 1317 OF * 1318 OF * 1319 OF * 1320 OF 1414 * 1414 (K*L*LA*LAK*LK) * 1418 * 1418 (E*K*R) * 1418 (L*LA*LAK*LK*R(LK)) * 1419 (L*LK*LS) * 1420 (L*LK*LS) 1417 OF * 1419 OF * 1421 OF 1421 OMC 321 LAP * LAPK * LAPS * LP * LPK * LPS 2414 (6X4) * 2414 (L) * 2418 (L*LB*LK) * 2420 (L*LB*LK) * 2423 B 6X4 * 2423 K 6X4 * 2425 6X6 (LA) * 2425 (L*LB*LK) * 2428 6X4	Caixa de Mudanças / Caja de Cambios / Gearbox
RMS 9 2RS / C3	BB	References Fersa with Multiple Applications / Referências Fersa com Múltiplas Aplicações / Referencias Fersa con Multiples Aplicaciones			Eixo Traseiro / Eje Trasero / Rear Axle

Fersa®			Brand / Marca / Marca	Model / Modelo / Modelo	Application / Aplicação / Aplicaciones			
T 163	TRBT		MASA	S 5000 * S 5002 * S 2030 S500T * S500U * S501U	Direção / Dirección / Steering			
			DINA	551 604 G1 * 604 G3 * 604 L1 * 604 L5 * 631 K1 * 631 K3 * 661 C1 * 661 G1 * 661 G2 * 661 G3				
		FAMSA	DC 10264 Autocar					
		DINA	311 * 312 * 314 * 362 * 315G * 316G * 317G6 * 318G * 319G * 321C * 323G					
T 182	TRBT		DINA	D-Avante Plus * D-Dorado DPC311774 * DPT231770 * DPC311970 * DPT311770 * DPT351970 * DPT352171 * DPT352172 * DPX281770 Paradiso * Quadro	Direção / Dirección / Steering			
			MASA	502 UX Jaguar * Condor * Géminis * Halcón * Strada * Premier 2030F S 5000 * S 5002 * S 2030				
			DINA	751 Multi Torque 861 K 9400				
		FAMSA	L1100, L1200, L1300, L1400, L1500, L1600, L2121					
			FREIGHTLINER	C-120 * Columbia * Coronado * CST 120 FLD 120				
			KENWORTH	T450, T450 B, T450 W T800 * Aerocab * Modular * SHW (Short hood wide) * HB * BSH Aerocab * SH 6X4 * 8X4 W900 * W924				
			DINA	433 16070 651 * 653 * 654 * 661 * 741				
		U 298 / U 261 L	U Series			CHRYSLER	Dart	Eixo Traseiro / Eje Trasero / Rear Axle
						NISSAN	D21 Ichivan	
		U 399 / U 360 L	U Series			CHRYSLER	Dart LeBaron	Eixo Traseiro / Eje Trasero / Rear Axle
DODGE	H100							
GENERAL MOTORS	C 1500							
JEEP	Comanche							
HYUNDAI	H100							
NISSAN	Frontier Titan X-Terra							
U 497 / U 460 L	U Series		NISSAN	D21	Eixo Traseiro / Eje Trasero / Rear Axle			
			NISSAN	D21				

OEM references list

Lista de referências OEM

Listado de referencias OEM

AGRALE	
Fersa	OEM
6004	
6007	
6008	
6013	
6205	
6206	
6207	
6210	
6211	
6303	
6304	
6305	
6306	
15106 / 15250 X	
25590 / 25522	4001.035.061.005
25877 / 25821	
2689 / 2631	
30203 F	
30205 F	
30207 F	
30208 F	
30305 F	
33281 / 33462	
3585 / 3525	
368 A / 362 A	
39581 / 39520	
39590 / 39520	4001.035.054.000
39590 / 39520	4001.035.055.007
3982 / 3920	
469 / 453	BG1X4220AA
47686 / 47620	
6007 N	
6201 2RS / C3	
6201 Z	
6202 Z	
6203 2RS / C3	
6204 2RS / C3	
6204 2RS / C3	
6204 ZZ	
6205 ZZ	
6206 ZZ	
6208 ZZ	
6303 2RS / C3	
6303 Z	
6305 C3	
HM 803146 / HM 803110	
HM 89449 / HM 89410	
LM 501349 / LM 501314	
M 802048 / M 802011	
NJ 309 F / C3	
NUP 309 FM / C3	

AGRALE	
OEM	Fersa
4001.035.054.000	39590 / 39520
4001.035.055.007	39590 / 39520
4001.035.061.005	25590 / 25522
BG1X4220AA	469 / 453
	6004
	6007
	6008
	6013
	6205
	6206
	6207
	6210
	6211
	6303
	6304
	6305
	6306
	15106 / 15250 X
	25877 / 25821
	2689 / 2631
	30203 F
	30205 F
	30207 F
	30208 F
	30305 F
	33281 / 33462
	3585 / 3525
	368 A / 362 A
	39581 / 39520
	3982 / 3920
	47686 / 47620
	6007 N
	6201 2RS / C3
	6201 Z
	6202 Z
	6203 2RS / C3
	6204 2RS / C3
	6204 2RS / C3
	6204 ZZ
	6205 ZZ
	6206 ZZ
	6208 ZZ
	6303 2RS / C3
	6303 Z
	6305 C3
	HM 803146 / HM 803110
	HM 89449 / HM 89410
	LM 501349 / LM 501314
	M 802048 / M 802011
	NJ 309 F / C3
	NUP 309 FM / C3

OEM REFERENCES LIST
 LISTA DE REFÊRENCIAS OEM
 LISTADO DE REFERENCIAS OEM

CHRYSLER	
Fersa	OEM
387 A / 382 S	91007313
496 / 493	
497 / 493	620244
498 / 493	
580 / 572	39811405
594 A / 592 A	183704
2780 / 2720	
3585 / 3525	
3782 / 3720	807949
3982 / 3920	2TA / 598313
14116 / 14276	
25590 / 25520	9414069
33275 / 33472	
33287 / 33462	
39581 / 39520	
39590 / 39520	1240A / 2986843
45284 / 45220	2986840
47686 / 47620	
55200 C / 55437	
55206 C / 55437	
56425 / 56650	
72188 C / 72487	
72200 C / 72487	
78225 C / 78551	
HM 212049 / HM 212011	
HM 88542 / HM 88510	457132
HM 903249 / HM 903210	931482
JM 716649 / JM 716610	
M 804049 / M 804010	

DINA	
Fersa	OEM
495 A / 493	
495 AX / 493	
496 / 493	
497 / 493	81.93420.0195
498 / 493	
567 / 563	354821
580 / 572	39811405
581 / 572	
594 A / 592 A	183704
598 A / 592 A	
3196 / 3120	
3767 / 372	
3782 / 3720	807949
3994 / 3920	06.32499.0145
9278 / 9220	
12168 / 12303	
12175 / 12303	
25590 / 25520	9414069
25590 / 25522	
25877 / 25820	
25880 / 25820	
29675 / 29630	
31594 / 31520	9415226
31597 / 31520	

CHRYSLER	
OEM	Fersa
183704	594 A / 592 A
457132	HM 88542 / HM 88510
620244	497 / 493
807949	3782 / 3720
931482	HM 903249 / HM 903210
2986840	45284 / 45220
9414069	25590 / 25520
39811405	580 / 572
91007313	387 A / 382 S
1240A / 2986843	39590 / 39520
2TA / 598313	3982 / 3920
	496 / 493
	498 / 493
	2780 / 2720
	3585 / 3525
	14116 / 14276
	33275 / 33472
	33287 / 33462
	39581 / 39520
	47686 / 47620
	55200 C / 55437
	55206 C / 55437
	56425 / 56650
	72188 C / 72487
	72200 C / 72487
	78225 C / 78551
	HM 212049 / HM 212011
	JM 716649 / JM 716610
	M 804049 / M 804010

DINA	
OEM	Fersa
32230	65237 / 65500
183345	JLM 714149 / JLM 714110
183704	594 A / 592 A
183844	JH 211749 / JH 211710
354821	567 / 563
807949	3782 / 3720
931482	HM 903249 / HM 903210
2986840	45284 / 45220
9414069	25590 / 25520
9415226	31594 / 31520
39811405	580 / 572
500587901	H 715334 / H 715311
500588901	H 715343 / H 715311
06.32499.0145	3994 / 3920
81.93420.0195	497 / 493
073 5371114	42381 / 42584
1240A / 2986843	39590 / 39520
181608 / 590762	47890 / 47820
C4TA1215B	HM 212047 / HM 212011
DIHA 3123 A2A	T 182
DIHA 3123 B2A	T 163
	495 A / 493
	495 AX / 493
	496 / 493

DINA	
Fersa	OEM
32021 XF	
33275 / 33472	
33895 / 33821	
34274 / 34492 A	
34306 / 34478	
39590 / 39520	1240A / 2986843
42346 / 42584	
42350 / 42384	
42381 / 42584	073 5371114
45284 / 45220	2986840
47686 / 47620	
47890 / 47820	181608 / 590762
49585 / 49520	
55200 C / 55437	
56425 / 56650	
65237 / 65500	32230
66225 / 66462	
68450 / 68712	
72188 C / 72487	
72200 C / 72487	
72212 C / 72487	
78215 C / 78551	
F 19034	
H 715334 / H 715311	500587901
H 715343 / H 715311	500588901
HM 212044 / HM 212011	
HM 212047 / HM 212011	C4TA1215B
HM 212049 / HM 212011	
HM 804846 / HM 804810	
HM 807046 / HM 807010	
HM 813843 / HM 813810	
HM 903249 / HM 903210	931482
JH 211749 / JH 211710	183844
JLM 710949 / JLM 710910	
JLM 714149 / JLM 714110	183345
JM 207049 / JM 207010	
JM 207049 A / JM 207010	
JM 511946 / JM 511910	
JM 716649 / JM 716610	
LM 104949 / LM 104910	
LM 603049 / LM 603011	
M 804049 / M 804010	
T 163	DIHA 3123 B2A
T 182	DIHA 3123 A2A

DODGE	
Fersa	OEM
368 A / 362 A	0915862 / 0915863
387 / 382 A	2986546
1380 / 1328	2986543
2780 / 2720	2686841
3982 / 3920	2986843
6200 2RSR / C3	2994254
6204 2RSR / C3	2994206
6204 2RSR / C3	620528

DINA	
OEM	Fersa
	498 / 493
	581 / 572
	598 A / 592 A
	3196 / 3120
	3767 / 372
	9278 / 9220
	12168 / 12303
	12175 / 12303
	25590 / 25522
	25877 / 25820
	25880 / 25820
	29675 / 29630
	31597 / 31520
	32021 XF
	33275 / 33472
	33895 / 33821
	34274 / 34492 A
	34306 / 34478
	42346 / 42584
	42350 / 42384
	47686 / 47620
	49585 / 49520
	55200 C / 55437
	56425 / 56650
	66225 / 66462
	68450 / 68712
	72188 C / 72487
	72200 C / 72487
	72212 C / 72487
	78215 C / 78551
	F 19034
	HM 212044 / HM 212011
	HM 212049 / HM 212011
	HM 804846 / HM 804810
	HM 807046 / HM 807010
	HM 813843 / HM 813810
	JLM 710949 / JLM 710910
	JM 207049 / JM 207010
	JM 207049 A / JM 207010
	JM 511946 / JM 511910
	JM 716649 / JM 716610
	LM 104949 / LM 104910
	LM 603049 / LM 603011
	M 804049 / M 804010

DODGE	
OEM	Fersa
620528	6204 2RSR / C3
2686841	2780 / 2720
2986542	LM 501349 / LM 501310
2986543	1380 / 1328
2986544	25590 / 25522
2986545	15106 / 15250 X
2986546	387 / 382 A
2986548	33287 / 33462

OEM REFERENCES LIST
 LISTA DE REFÊRENCIAS OEM
 LISTADO DE REFERENCIAS OEM

DODGE	
Fersa	OEM
6204 2RSR / C3	2994207
6211 ZNR	2994911
6307 ZNR	2994909
6308 N	2994910
6308 ZNR	
15106 / 15250 X	2986545
25590 / 25522	2986544
33281 / 33462	2986596
33287 / 33462	2986548
39590 / 39520	2986843
42688 / 42620	2986849
45284 / 45220	2986840
47686 / 47620	2986842
JM 714249 / JM 714210	
LM 501349 / LM 501310	2986542

DODGE	
OEM	Fersa
2986596	33281 / 33462
2986840	45284 / 45220
2986842	47686 / 47620
2986843	3982 / 3920
2986843	39590 / 39520
2986849	42688 / 42620
2994206	6204 2RSR / C3
2994207	6204 2RSR / C3
2994254	6200 2RSR / C3
2994909	6307 ZNR
2994910	6308 N
2994911	6211 ZNR
0915862 / 0915863	368 A / 362 A
	6308 ZNR
	JM 714249 / JM 714210

FAMSA	
Fersa	OEM
3782 / 3720	807949
387 A / 382 A	
39590 / 39520	1240A / 2986843
3982 / 3920	2TA / 598313
42381 / 42584	7451400
42584 / 42381	
47686 / 47620	
47890 / 47820	590762
497 / 493	06.32499.0146
55200 C / 55437	
56425 / 56650	
580 / 572	39811405
641 / 632	
6461A / 6420	
65237 / 65500	32230
681 A / 672	
72200 C / 72487	
72212 C / 72487	
749 / 742	
760 / 752	
H 715334 / H 715311	500587901
H 715345 / H 715311	
HM 212044 / HM 212011	
HM 212047 / HM 212011	C4TA1215B
HM 516449 / HM 516410	
HM 807040 / HM 807010	451983
HM 807046 / HM 807010	
T 163	DIHA 3123 B2A
T 182	DIHA 3123 A2A

FAMSA	
OEM	Fersa
32230	65237 / 65500
451983	HM 807040 / HM 807010
590762	47890 / 47820
807949	3782 / 3720
7451400	42381 / 42584
39811405	580 / 572
500587901	H 715334 / H 715311
06.32499.0146	497 / 493
1240A / 2986843	39590 / 39520
2TA / 598313	3982 / 3920
C4TA1215B	HM 212047 / HM 212011
DIHA 3123 A2A	T 182
DIHA 3123 B2A	T 163
	387 A / 382 A
	42584 / 42381
	47686 / 47620
	55200 C / 55437
	56425 / 56650
	641 / 632
	6461A / 6420
	681 A / 672
	72200 C / 72487
	72212 C / 72487
	749 / 742
	760 / 752
	H 715345 / H 715311
	HM 212044 / HM 212011
	HM 516449 / HM 516410
	HM 807046 / HM 807010

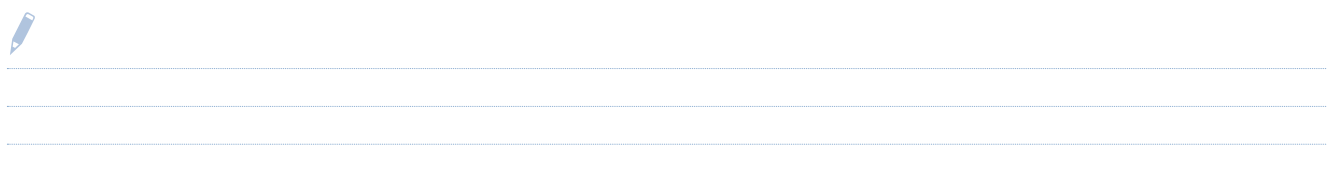

FIAT	
Fersa	OEM
368 A / 362 A	502156
594 / 592 A	
594 / 592 A	1701 / 31022
3982 / 3920	502155
6009	
6010	2 / 804250 / 0
6011	96105 / 4478
6011	9610 / 54478
6017 NR	
6201 ZZ	
6202 2RS	
6202 ZZ	9604 / 55102
6203 ZZ	9604 / 55099
6205	
6205 Z	2 / 804320 / 0
6206 ZZ / C3	
6206 ZZ / C3	4690063
6207	9610 / 54467
6207 C3	
6209	
6212	
6212 ZNR	
6214	
6302	2900 / 60112
6302	
6304	2900 / 60114
6304 2RS	
6306 2RS	1610 / 2300200
6308	
6310	
6310 2RS	
6311	
6314 NR / C3	
6408	
6408	2900 / 60165
6409	
30203 F	9625 / 47014
30204 F	9625 / 47015
30207 F	2900 / 62204
30213 F	
30222 F	
30306 F	2680 / 00340
30307 F	
30309 F	2680 / 0370
31312 F	12080 / 1725200
31312 F	12080 / 17253
31313 F	
31314 F	
32206 F	
32213 F	2910 / 62247
32213 F	
32214 F	701109
32219 F	2920 / 62253
32304 F	2900 / 623120
32308 F	2680 / 0610
32309 F	2900 / 62317

FIAT	
OEM	Fersa
502155	3982 / 3920
502156	368 A / 362 A
701109	32214 F
4690063	6206 ZZ / C3
12080 / 1725200	31312 F
12080 / 17253	31312 F
1610 / 2300200	6306 2RS
1701 / 31022	594 / 592 A
2 / 804250 / 0	6010
2 / 804320 / 0	6205 Z
2680 / 00340	30306 F
2680 / 0370	30309 F
2680 / 0580	32311 F
2680 / 0610	32308 F
2900 / 60112	6302
2900 / 60114	6304
2900 / 60165	6408
2900 / 62204	30207 F
2900 / 623120	32304 F
2900 / 62317	32309 F
2900 / 62320	32312 F
2910 / 62247	32213 F
2910 / 62321	32313 F
2920 / 62253	32219 F
9604 / 55099	6203 ZZ
9604 / 55102	6202 ZZ
9610 / 54467	6207
9610 / 54478	6011
96105 / 4478	6011
9625 / 47014	30203 F
9625 / 47015	30204 F
	594 / 592 A
	6009
	6017 NR
	6201 ZZ
	6202 2RS
	6205
	6206 ZZ / C3
	6207 C3
	6209
	6212
	6212 ZNR
	6214
	6302
	6304 2RS
	6308
	6310
	6310 2RS
	6311
	6314 NR / C3
	6408
	6409
	30213 F
	30222 F
	30307 F
	31313 F

OEM REFERENCES LIST
 LISTA DE REFÊRENCIAS OEM
 LISTADO DE REFERENCIAS OEM

FIAT	
Fersa	OEM
32311 F	2680 / 0580
32312 F	2900 / 62320
32313 F	2910 / 62321
32315 F	
HM 807040 / HM 807010	
HM 807046 / HM 807010	
HM 88542 / HM 88510	
NUP 314 FMNR	
NUP 314 FMNR / C3	

FORD	
Fersa	OEM
387 / 382 A	
387 A / 382 S	91007313
387 AS / 382 A	
469 / 453	
469 / 453 X	
495 AX / 493	
496 / 493	
497 / 493	7451380
497 / 493	620244
498 / 493	
555 S / 552 A	
580 / 572	TAJAA1240A
580 / 572	SKTAJAA1238A
594 A / 592 A	D7AH1244AA / TUAA1243A
594 A / 592 A	003 9811405
594 A / 592 A	183704
2780 / 2720	BD2T1216A / 1217A
3585 / 3525	8EB1216 / 81T1202
3782 / 3720	NCB44134A
3782 / 3720	B5QM1216A / 9N4222
3782 / 3720	B5QM1216A
3782 / 3720	807949
3982 / 3920	B6T1243A / 1244A
3982 / 3920	94630960
6200 2RS	
6201 2RS / C3	BDOT7580A
6203	
6203 2RS	707600 B
6203 2RS / C3	7RA10094A
6203 ZZ	707600 B
6204 2RS	
6204 2RS / C3	
6205 2RS / C3	
6206 2RS / C3	
6211 ZNR	BC5T7025A
62201 2RS / C3	BE5H10A303B
62201 2RS / C3	
6305 2RS	
6307 ZNR	
6308 N	7EQ7065
6308 NR	BC5T765A
6309 NR	BDO7065
6403 2RS / C3	BE5H10A303A
6403 2RS / C3	

FIAT	
OEM	Fersa
	31314 F
	32206 F
	32213 F
	32315 F
	HM 807040 / HM 807010
	HM 807046 / HM 807010
	HM 88542 / HM 88510
	NUP 314 FMNR
	NUP 314 FMNR / C3

FORD	
OEM	Fersa
183704	594 A / 592 A
620244	497 / 493
807949	3782 / 3720
931482	HM 903249 / HM 903210
7451380	497 / 493
11440284	HM 88542 / HM 88510
91007313	387 A / 382 S
94630960	3982 / 3920
500588901	H 715343 / H 715311
003 9811405	594 A / 592 A
291407625A	LM 501349 / LM 501310
707600 B	6203 2RS
707600 B	6203 ZZ
71LB4625A1A	HM 807040 / HM 807010
7EQ7065	6308 N
7EQH1238	39590 / 39520
7EQH1238	47686 / 47620
7RA10094A	6203 2RS / C3
85HU4221A / 1243A	42381 / 42584
85HU7025B	M 802048 / M 802011
85HU7118A	25877 / 25821
87HU4621AA / 4616	M 802048 / M 802011
8EB1216 / 81T1202	3585 / 3525
8M4630	31594 / 31520
8Q1200A	39581 / 39520
8Q1201A / TGAA1202A	39581 / 45220
91T1216A	15106 / 15250 X
9415470 / 477080	31594 / 31520
B28T4A000G	HM 803145 / HM 803110
B5QM1216A	3782 / 3720
B5QM1216A / 9N4222	3782 / 3720
B6T1243A / 1244A	3982 / 3920
B7T1201A	25590 / 25522
B7T1201A / E7HZ7K228A	25590 / 25522
BC5T7025A	6211 ZNR
BC5T765A	6308 NR
BC8T4A000C	HM 807040 / HM 807010
BC8T4A000C	HM 807046 / HM 807010
BC8T4A000H	59162 / 59412
BC8T4A000H	59175 / 59412
BC8T4A000K	33287 / 33462
BD0T1239A / BD0T1240A	39590 / 39520
BD2T1216A / 1217A	2780 / 2720
BD2T4561A	42688 / 42620

FORD	
Fersa	OEM
6461A / 6420	
15101 / 15245	
15106 / 15250 X	91T1216A
25581 / 25520	
25590 / 25520	
25590 / 25522	B7T1201A / E7HZ7K228A
25590 / 25522	B7T1201A
25877 / 25821	85HU7118A
25880 / 25820	
30203 F	
30204 F	
31594 / 31520	
31594 / 31520	8M4630
31594 / 31520	9415470 / 477080
32015 XF	
32021 XF	
33275 / 33472	
33281 / 33462	
33287 / 33462	BC8T4A000K
33287 / 33462	
39250 / 39412	
39581 / 39520	8Q1200A
39581 / 45220	8Q1201A / TGAA1202A
39590 / 39520	7EQH1238
39590 / 39520	BDOT1239A / 1240A
39590 / 39520	BD0T1239A / BD0T1240A
42381 / 42584	85HU4221A / 1243A
42688 / 42620	BD2T4561A
45284 / 45220	TGAA1201A / 1202A
45284 / 45220	
47686 / 47620	BD8T1243B
47686 / 47620	7EQH1238
52400 / 52618	
55200 C / 55437	
55206 C / 55437	
56425 / 56650	
59162 / 59412	BC8T4A000H
59175 / 59412	BC8T4A000H
65237 / 65500	
68462 / 68712	
72188 C / 72487	
72200 C / 72487	
78225 C / 78551	
H 715343 / H 715311	500588901
HM 212047 / HM 212011	C4TA1215B
HM 212047 / HM 212011	C4TA1215B / D6HS1240AA
HM 212049 / HM 212011	D6HHS1240AA
HM 803145 / HM 803110	B28T4A000G
HM 803149 / HM 803110	
HM 804843 / HM 804810	BD2T4615A
HM 804846 / HM 804810	
HM 807040 / HM 807010	BC8T4A000C
HM 807040 / HM 807010	71LB4625A1A
HM 807046 / HM 807010	BC8T4A000C
HM 807046 / HM 807011	
HM 813842 / HM 813810	BD2T4625A

FORD	
OEM	Fersa
BD2T4615A	HM 804843 / HM 804810
BD2T4625A	HM 813842 / HM 813810
BD8T1243B	47686 / 47620
BDO7065	6309 NR
BDOT1239A / 1240A	39590 / 39520
BDOT12438	JM 714249 / JM 714210
BDOT7580A	6201 2RS / C3
BE5H10A303A	6403 2RS / C3
BE5H10A303B	62201 2RS / C3
C4TA1215B	HM 212047 / HM 212011
C4TA1215B / D6HS1240AA	HM 212047 / HM 212011
D6HHS1240AA	HM 212049 / HM 212011
D7AH1244AA / TUAA1243A	594 A / 592 A
NCB44134A	3782 / 3720
SKTAJAA1238A	580 / 572
TAJAA1240A	580 / 572
TGAA1201A / 1202A	45284 / 45220
	387 / 382 A
	387 AS / 382 A
	469 / 453
	469 / 453 X
	495 AX / 493
	496 / 493
	498 / 493
	555 S / 552 A
	6200 2RS
	6203
	6204 2RS
	6204 2RS / C3
	6205 2RS / C3
	6206 2RS / C3
	62201 2RS / C3
	6305 2RS
	6307 ZNR
	6403 2RS / C3
	6461A / 6420
	15101 / 15245
	25581 / 25520
	25590 / 25520
	25880 / 25820
	30203 F
	30204 F
	31594 / 31520
	32015 XF
	32021 XF
	33275 / 33472
	33281 / 33462
	33287 / 33462
	39250 / 39412
	45284 / 45220
	52400 / 52618
	55200 C / 55437
	55206 C / 55437
	56425 / 56650
	65237 / 65500
	68462 / 68712

OEM REFERENCES LIST
 LISTA DE REFÊRENCIAS OEM
 LISTADO DE REFERENCIAS OEM

FORD	
Fersa	OEM
HM 88542 / HM 88510	11440284
HM 89443 / HM 89411	
HM 903249 / HM 903210	931482
JLM 104946 / JLM 104911 A	
JM 714249 / JM 714210	BDOT12438
JM 716649 / JM 716610	
JP 12049 / JP 12010	
LM 102949 / LM 102910	
LM 104949 / LM 104911	
LM 501349 / LM 501310	
LM 501349 / LM 501310	291407625A
M 802048 / M 802011	85HU7025B
M 802048 / M 802011	87HU4621AA / 4616
M 804049 / M 804010	

FORD	
OEM	Fersa
	72188 C / 72487
	72200 C / 72487
	78225 C / 78551
	HM 803149 / HM 803110
	HM 804846 / HM 804810
	HM 807046 / HM 807011
	HM 89443 / HM 89411
	JLM 104946 / JLM 104911 A
	JM 716649 / JM 716610
	JP 12049 / JP 12010
	LM 102949 / LM 102910
	LM 104949 / LM 104911
	LM 501349 / LM 501310
	M 804049 / M 804010

FREIGHTLINER	
Fersa	OEM
555 S / 552 A	
580 / 572	
594 A / 592 A	183704
3782 / 3720	B5QM1216A
3982 / 3920	94630960
6461A / 6420	
25580 / 25520	
25590 / 25520	
25590 / 25522	B7T1201A
25877 / 25820	
31594 / 31520	9415470 / 477080
32020 XF	0019816405
33287 / 33462	
34306 / 34478	
39590 / 39520	
42381 / 42584	3315955
45284 / 45220	
47686 / 47620	7EQH1238
47890 / 47820	
52400 / 52618	
55200 C / 55437	
55206 C / 55437	
65237 / 65500	
72212 C / 72487	
78225 C / 78551	
F 19034	
H 715334 / H 715311	500587901
H 715343 / H 715311	500588901
HM 212047 / HM 212011	C4TA1215B
HM 212049 / HM 212011	
HM 804846 / HM 804810	
HM 813843 / HM 813810	
JH 211749 / JH 211710	23336042
JLM 710949 / JLM 710910	
JLM 710949 C / JLM 710910	
JLM 714149 / JLM 714110	3459817118
JM 207049 A / JM 207010	
JM 511946 / JM 511910	

FREIGHTLINER	
OEM	Fersa
183704	594 A / 592 A
3315955	42381 / 42584
0019816405	32020 XF
23336042	JH 211749 / JH 211710
94630960	3982 / 3920
500587901	H 715334 / H 715311
500588901	H 715343 / H 715311
3459817118	JLM 714149 / JLM 714110
7EQH1238	47686 / 47620
9415470 / 477080	31594 / 31520
B5QM1216A	3782 / 3720
B7T1201A	25590 / 25522
C4TA1215B	HM 212047 / HM 212011
DIHA 3123 A2A	T 182
	555 S / 552 A
	580 / 572
	6461A / 6420
	25580 / 25520
	25590 / 25520
	25877 / 25820
	33287 / 33462
	34306 / 34478
	39590 / 39520
	45284 / 45220
	47890 / 47820
	52400 / 52618
	55200 C / 55437
	55206 C / 55437
	65237 / 65500
	72212 C / 72487
	78225 C / 78551
	F 19034
	HM 212049 / HM 212011
	HM 804846 / HM 804810
	HM 813843 / HM 813810
	JLM 710949 / JLM 710910
	JLM 710949 C / JLM 710910
	JM 207049 A / JM 207010

FREIGHTLINER	
Fersa	OEM
JM 716649 / JM 716610	
LM 104949 / LM 104910	
M 802048 / M 802011	
M 804049 / M 804010	
T 182	DIHA 3123 A2A

GENERAL MOTORS	
Fersa	OEM
368 A / 362 A	
3782 / 3720	7326379 / 94632998
387 A / 382 A	
387 AS / 382 A	
497 / 493	
580 / 572	600704011
594 / 592 A	
594 A / 592 A	183704
2780 / 2720	94223337
3982 / 3920	
6203 2RS	
6205 Z	94642765
6205 ZZ	94642765
6211 ZNR	
6307 ZNR	
6308 N	
6308 NR	
6308 ZNR	
6309 NR	
15103S / 15243	
15106 / 15250 X	7319666
25580 / 25520	
25590 / 25520	
25590 / 25522	7319663
25877 / 25821	
31594 / 31520	
32307 F	
33208 F	072 003 32 08
33287 / 33462	457439
39590 / 39520	7451070
42381 / 42584	
45284 / 45220	7451119
47686 / 47620	446051
55200 C / 55437	
56425 / 56650	
72200 C / 72487	
HM 807040 / HM 807010	
HM 807046 / HM 807010	
HM 903249 / HM 903210	
LM 104949 / LM 104911	
LM 501349 / LM 501310	00457233
M 802048 / M 802011	9418356
M 802048 / M 802011	4,00104E+12
M 804049 / M 804010	

FREIGHTLINER	
OEM	Fersa
	JM 511946 / JM 511910
	JM 716649 / JM 716610
	LM 104949 / LM 104910
	M 802048 / M 802011
	M 804049 / M 804010

GENERAL MOTORS	
OEM	Fersa
183704	594 A / 592 A
446051	47686 / 47620
00457233	LM 501349 / LM 501310
457439	33287 / 33462
7319663	25590 / 25522
7319666	15106 / 15250 X
7451070	39590 / 39520
7451119	45284 / 45220
9418356	M 802048 / M 802011
94223337	2780 / 2720
94642765	6205 Z
94642765	6205 ZZ
600704011	580 / 572
4001035070006	M 802048 / M 802011
072 003 32 08	33208 F
7326379 / 94632998	3782 / 3720
	368 A / 362 A
	387 A / 382 A
	387 AS / 382 A
	497 / 493
	594 / 592 A
	3982 / 3920
	6203 2RS
	6211 ZNR
	6307 ZNR
	6308 N
	6308 NR
	6308 ZNR
	6309 NR
	15103S / 15243
	25580 / 25520
	25590 / 25520
	25877 / 25821
	31594 / 31520
	32307 F
	42381 / 42584
	55200 C / 55437
	56425 / 56650
	72200 C / 72487
	HM 807040 / HM 807010
	HM 807046 / HM 807010
	HM 903249 / HM 903210
	LM 104949 / LM 104911
	M 804049 / M 804010

OEM REFERENCES LIST
 LISTA DE REFÊRENCIAS OEM
 LISTADO DE REFERENCIAS OEM

INTERNATIONAL	
Fersa	OEM
497 / 493	
555 S / 552 A	
567 / 563	354821 / 658623
580 / 572	
594 A / 592 A	0039811405 / 183704
3782 / 3720	807949
25580 / 25520	
25590 / 25520	9414069
25590 / 25522	
29675 / 29630	
31594 / 31520	
39590 / 39520	
47890 / 47820	181608 / 590762
55200 C / 55437	
55206 C / 55437	
56425 / 56650	
72212 C / 72487	
78225 C / 78551	
F 19034	
H 715334 / H 715311	500587901
H 715343 / H 715311	500588901
HM 212047 / HM 212011	C4TA1215B
HM 212049 / HM 212011	
JM 716649 / JM 716610	
M 802048 / M 802011	
M 804049 / M 804010	

IVECO	
Fersa	OEM
78225 C / 78551	
F 15047	0019801402
F 19010	
F 19039	
F 300006	

KENWORTH	
Fersa	OEM
497 / 493	
555 S / 552 A	
567 / 563	658623
580 / 572	
594 A / 592 A	183704
598 A / 592 A	
3782 / 3720	807949
6461A / 6420	
25590 / 25522	
31594 / 31520	
39590 / 39520	
45284 / 45220	
47890 / 47820	
52400 / 52618	
55200 C / 55437	
65237 / 65500	8Q4625A
72212 C / 72487	
F 19034	

INTERNATIONAL	
OEM	Fersa
807949	3782 / 3720
9414069	25590 / 25520
500587901	H 715334 / H 715311
500588901	H 715343 / H 715311
0039811405 / 183704	594 A / 592 A
181608 / 590762	47890 / 47820
354821 / 658623	567 / 563
C4TA1215B	HM 212047 / HM 212011
	497 / 493
	555 S / 552 A
	580 / 572
	25580 / 25520
	25590 / 25522
	29675 / 29630
	31594 / 31520
	39590 / 39520
	55200 C / 55437
	55206 C / 55437
	56425 / 56650
	72212 C / 72487
	78225 C / 78551
	F 19034
	HM 212049 / HM 212011
	JM 716649 / JM 716610
	M 802048 / M 802011
	M 804049 / M 804010

IVECO	
OEM	Fersa
0019801402	F 15047
	78225 C / 78551
	F 19010
	F 19039
	F 300006

KENWORTH	
OEM	Fersa
183704	594 A / 592 A
658623	567 / 563
807949	3782 / 3720
500587901	H 715334 / H 715311
500588901	H 715343 / H 715311
735370574	JLM 714149 / JLM 714110
073 5370606	JH 211749 / JH 211710
8Q4625A	65237 / 65500
C4TA1215B	HM 212047 / HM 212011
DIHA 3123 A2A	T 182
	497 / 493
	555 S / 552 A
	580 / 572
	598 A / 592 A
	6461A / 6420
	25590 / 25522
	31594 / 31520
	39590 / 39520

KENWORTH	
Fersa	OEM
H 715334 / H 715311	500587901
H 715343 / H 715311	500588901
H 914841 / H 914811	
HM 212047 / HM 212011	C4TA1215B
HM 212049 / HM 212011	
HM 804846 / HM 804810	
JH 211749 / JH 211710	073 5370606
JLM 714149 / JLM 714110	735370574
JM 716649 / JM 716610	
LM 104949 / LM 104910	
T 182	DIHA 3123 A2A

KENWORTH	
OEM	Fersa
	45284 / 45220
	47890 / 47820
	52400 / 52618
	55200 C / 55437
	72212 C / 72487
	F 19034
	H 914841 / H 914811
	HM 212049 / HM 212011
	HM 804846 / HM 804810
	JM 716649 / JM 716610
	LM 104949 / LM 104910

MACK	
Fersa	OEM
555 S / 552 A	
580 / 572	SKTAJAA1238A
594 A / 592 A	183704
3782 / 3720	807949
6461A / 6420	
45284 / 45220	2986840
HM 212049 / HM 212011	

MACK	
OEM	Fersa
183704	594 A / 592 A
807949	3782 / 3720
2986840	45284 / 45220
SKTAJAA1238A	580 / 572
	555 S / 552 A
	6461A / 6420
	HM 212049 / HM 212011

MACK	
Fersa	OEM
555 S / 552 A	
580 / 572	SKTAJAA1238A
594 A / 592 A	183704
3782 / 3720	807949
6461A / 6420	
45284 / 45220	2986840
HM 212049 / HM 212011	

MACK	
OEM	Fersa
183704	594 A / 592 A
807949	3782 / 3720
2986840	45284 / 45220
SKTAJAA1238A	580 / 572
	555 S / 552 A
	6461A / 6420
	HM 212049 / HM 212011

MERCEDES BENZ	
Fersa	OEM
497 / 492 A	000 981 61 05
497 / 493	7451380
498 / 492 A	0039812005
559 / 552 A	3449817005
580 / 572	0039811405
580 / 572	600704011
594 A / 592 A	183704
598 A / 593 X	0039811405
3782 / 3720	B5QM1216A / 9N4222
3982 / 3920	94630960
2789 / 2720	
3382 / 3320	050 139 82 17
6004	000625006004
6004	000625006204
6007	000625006007
6007 N	000625506007
6009 C3	000625036009
6011	
6011	000625006011
6014 C3	000625036014

MERCEDES BENZ	
OEM	Fersa
174716	31312 F
181342	H 715345 / H 715311
183704	594 A / 592 A
184623	32017 XF
477080	31594 / 31520
2986843	39590 / 39520
3315955	42381 / 42584
7451380	497 / 493
0009813105	QJ 309 FM
0009813427	QJ 208 FM
0019800102	32310 F
0019801402	F 15047
0019807802	F 15047
0019809502	33889 / 33822
0019809502	33889 / 33882
0019809602	33885 / 33822
0019809802	NUP 314 FM / C3
0019811701	NU 209 FMN
0019815705	30306 F
0019817405	32310 F

OEM REFERENCES LIST
 LISTA DE REFÊRENCIAS OEM
 LISTADO DE REFERENCIAS OEM

MERCEDES BENZ	
Fersa	OEM
6201 2RS / C3	0049812425
6201 2RS / C3	0089810705
6201 RS / C3	0049812425
6201 Z / C3	
6201 ZZ / C3	0049812425
6203	000625006203
6203	000625900208
6203 2RS / C3	0089810605
6203 C3	000625900208
6204	000625006204
6204	000625006004
6204 2RS	000625006204
6204 2RS	000625406104
6204 2RS / C3	000625406204
6204 2RS / C3	0039815125
6205	000625006205
6205 2RS	000625406205
6206	000625006206
6206	000625006006
6206 2RS	000625900209
6206 C3	000625006206
6206 C3	000625900209
6208	000625006208
6208 N	000625506208
6209 C3	000625036209
6209 C3	000625506208
6210	000625006210
6211 C3	000625036211
6211 N / C3	0019819125
6211 N / C3	0059819125
6213 C3	
6216 C3	
6218 C3	
62201 2RS / C3	0029819095
62201 2RS / C3	00298190 (77...)95
62201 2RS / C3	000625406303
62201 2RS / C3	00298190 (77...)25
62201 2RS / C3	0029819025
62204 2RS	0049819625
6302	000625006302
6303	000635006303
6303 2RS / C3	000625406303
6303 2RS / C3	000625406303 / 000625900193
6303 2RS / C3	0049812425
6303 RS / C3	000625900182
6303 RS / C3	0049812425
6303 Z / C3	000625900193
6303 Z / C3	000625900182
6303 ZZ / C3	000625900182
6303 ZZ / C3	000625900193
6304	
6304 2RS / C3	0049812425
6304 C3	000635006303
6305	000625006305
6308 ZNR / C3	3129811325
6309 Z / C3	

MERCEDES BENZ	
OEM	Fersa
0019818705	32306 F
0019819005	32304 F
0019819125	6211 N / C3
0019819601	NU 303 FM
0019819601	NU 303 FM / C3
0019819705	30312 F
0019819802	NUP 314 FM / C3
0029810505	33895 / 33822
0029815005	32022 XF
0029815405	32019 XF
0029818905	33215 F
0029819025	62201 2RS / C3
0029819095	62201 2RS / C3
0029819305	33011 F
0039810605	31313 F
0039811405	580 / 572
0039811405	598 A / 593 X
0039811605	33109 F
0039812005	498 / 492 A
0039812605	33021 F
0039813005	33115 F
0039813105	32314 BF
0039815125	6204 2RS / C3
0039815705	33209 F
0039818305	33210 F
0049810905	33022 F
0049811305	32309 F
0049812425	6201 2RS / C3
0049812425	6201 RS / C3
0049812425	6201 ZZ / C3
0049812425	6303 2RS / C3
0049812425	6303 RS / C3
0049812425	6304 2RS / C3
0049812425	6403 2RS / C3
0049812425	6403 C3
0049814305	32018 XF
0049814906	30220 F
49815801	F 19019
0049819625	62204 2RS
0059810505	31313 F
59810705	33207 F
0059812805	33212 F
0059813105	F 15051 C
0059815201	NUP 311 FM / C3
0059818505	33020 F
0059818605	33117 F
0059819125	6211 N / C3
0089810005	33213 F
0089810605	6203 2RS / C3
0089810705	6201 2RS / C3
94630960	3982 / 3920
00198113705	30309 F
0319811805	H 715345 / H 715311
600704011	580 / 572
000625006004	6004
000625006004	6204

MERCEDES BENZ	
Fersa	OEM
6310 C3	000625006310
6311 C3	
6312 C3	000625036312
6313 C3	
6314	
6314 C3	000625536314
6314 NR / C3	00198190 (77...)25
6403 2RS / C3	0049812425
6403 2RS / C3	
6403 2RS / C3	0049812425 / 0049811825
6403 C3	0049812425
25590 / 25520	
25590 / 25522	B7T1201A / E7HZ7K228A
25877 / 25820	
30203 F	000720030203
30204 F	000720030204
30205 F	000720030205
30206 F	000720030206
30214 F	
30216 F	
30220 F	0049814906
30220 F	004 981 2105
30302 F	000720030202
30306 F	0019815705
30306 F	
30306 F	001 981 57 05
30308 F	0019813105 / 0019815005
30309 F	00198113705
30312 F	0019819705
30312 F	001 981 97 05
30313 F	000720030313
33895 / 33822	002 981 05 05
31311 F	
31312 F	174716
31313 F	0039810605
31313 F	0059810505
31594 / 31520	477080
32011 XF	002 981 6605
32012 XF	007 981 2105
32014 XF	005 981 6605
32015 XF	
32016 XF	0079819005 / 00720032016
32017 XF	005 981 1405
32017 XF	184623
32018 XF	004 981 4305
32018 XF	0049814305
32018 XF	004 981 43 05
32019 XF	0029815405
32020 XF	001 981 6405
32020 XF	001 981 64 05
32022 XF	002 981 5005
32022 XF	0029815005
32024 XF	014 981 4405
32205 BF	
32205 F	000720032205
32208 F	A0159813405

MERCEDES BENZ	
OEM	Fersa
000625006006	6206
000625006007	6007
000625006011	6011
000625006203	6203
000625006204	6004
000625006204	6204
000625006204	6204 2RS
000625006205	6205
000625006206	6206
000625006206	6206 C3
000625006208	6208
000625006210	6210
000625006302	6302
000625006305	6305
000625006310	6310 C3
000625036009	6009 C3
000625036014	6014 C3
000625036209	6209 C3
000625036211	6211 C3
000625036312	6312 C3
000625406104	6204 2RS
000625406204	6204 2RS / C3
000625406205	6205 2RS
000625406303	62201 2RS / C3
000625406303	6303 2RS / C3
000625506007	6007 N
000625506208	6208 N
000625506208	6209 C3
000625536314	6314 C3
000625900182	6303 RS / C3
000625900182	6303 Z / C3
000625900182	6303 ZZ / C3
000625900193	6303 Z / C3
000625900193	6303 ZZ / C3
000625900208	6203
000625900208	6203 C3
000625900209	6206 2RS
000625900209	6206 C3
000628000339	NJ 2211 FM
000635006303	6303
000635006303	6304 C3
000720030202	30302 F
000720030203	30203 F
000720030204	30204 F
000720030205	30205 F
000720030206	30206 F
000720030313	30313 F
000720032205	32205 F
3129810001	32214 F
3129810101	32212 F
3129810205	32306 F
3129811325	6308 ZNR / C3
3449817005	559 / 552 A
3449817101	NU 209 FMN
3459817027	QJ 209 FM
3459817027	QJ 209 FM

OEM REFERENCES LIST
 LISTA DE REFÊRENCIAS OEM
 LISTADO DE REFERENCIAS OEM

MERCEDES BENZ	
Fersa	OEM
32208 F	LA5113
32210 F	A0159815005
32210 F	LA5115
32212 F	3129810101
32214 F	001 981 8005
32214 F	3129810001
32216 F	000 981 72 05
32218 F	072 003 22 18
32219 F	000 981 21 05
32304 F	0019819005
32305 F	007200032305
32306 F	0019818705
32306 F	3129810205
32307 F	003 981 64 05
32309 F	0049811305
32309 F	004 981 13 05
32310 F	0019817405
32310 F	0019800102
32310 F	001 981 7405
32310 F	001 981 74 05
32312 F	011 981 6905
32312 F	0119816805 / 0119816905
32313 F	
32314 BF	0039813105
32314 BF	003 981 31 05
33011 F	0029819305
33019 F	00298190 (77...)05 / 0039818605
33020 F	0059818505
33020 F	014 981 3205
33020 F	005 981 84 05
33021 F	0039812605
33022 F	009 981 0905
33022 F	0049810905
33022 F	004 981 0905
33109 F	0039811605
33111 F	0069807205 / 0009807502
33112 F	
33113 F	
33114 F	
33115 F	0039813005
33115 F	003 981 30 05
33116 F	012 981 4005
33116 F	004 981 2105 / 012 981 4005
33117 F	0059818605
33205 F	6889817005
33207 F	59810705
33207 F	005 981 0705
33208 F	3849817605 / 0089810105
33209 F	0039815705
33210 F	0039818305
33210 F	003 981 8305
33210 F	003 981 83 05
33212 F	0059812805
33213 F	0089810005
33214 F	0039815605 / 0039815205
33214 F	003 981 5205

MERCEDES BENZ	
OEM	Fersa
3459817101	NU 208 FM
3459817118	JLM 714149 / JLM 714110
3459817501	F 19015
3459817627	QJ 212 FM
3459817627	QJ 212 FM
005412400004	NJ 305 FM / C3
005412400004	NUP 206 FM
005412400304	NJ 304 FM
005412400304	NJ 304 FMN
005412402216	NJ 2206 FM
6889817005	33205 F
007200032305	32305 F
000 981 21 05	32219 F
000 981 61 05	497 / 492 A
000 981 72 05	32216 F
000625406303 / 000625900193	6303 2RS / C3
001 981 57 05	30306 F
001 981 64 05	32020 XF
001 981 6405	32020 XF
001 981 74 05	32310 F
001 981 7405	32310 F
001 981 8005	32214 F
001 981 97 05	30312 F
001 981 98 02	NUP 314 FMNR / C3
001 981 99 05	F 15082
0019813105 / 0019815005	30308 F
00198190 (77...)25	6314 NR / C3
002 981 05 05	33895 / 33822
002 981 5005	32022 XF
002 981 6605	32011 XF
0029818905 / 0029818605	33215 F
00298190 (77...)05 / 0039818605	33019 F
00298190 (77...)25	62201 2RS / C3
00298190 (77...)95	62201 2RS / C3
003 981 19 05	F 15083
003 981 30 05	33115 F
003 981 31 05	32314 BF
003 981 5205	33214 F
003 981 64 05	32307 F
003 981 83 05	33210 F
003 981 8305	33210 F
003981190 (77...)5	F 15083
0039815605 / 0039815205	33214 F
004 981 0905	33022 F
004 981 13 05	32309 F
004 981 2105	30220 F
004 981 2105 / 012 981 4005	33116 F
004 981 43 05	32018 XF
004 981 4305	32018 XF
0049812425 / 0049811825	6403 2RS / C3
005 981 0705	33207 F
005 981 1405	32017 XF
005 981 30 05	F 15051 C
005 981 3105	F 15051 C
005 981 6605	32014 XF
005 981 84 05	33020 F

MERCEDES BENZ	
Fersa	OEM
33215 F	0029818905 / 0029818605
33215 F	0029818905
33287 / 33462	
33885 / 33822	0019809602
33889 / 33822	0019809502
33889 / 33882	0019809502
33895 / 33822	0029810505
39590 / 39520	2986843
42381 / 42584	3315955
45284 / 45220	
47487 / 47420 A	
47686 / 47620	7EQH1238
55200 C / 55437	
56425 / 56650	
72188 C / 72487	
72200 C / 72487	
72218 C / 72487	
F 15047	0019801402
F 15047	0019807802
F 15047	073 537 00 55
F 15051 C	0059813105
F 15051 C	005 981 3105
F 15051 C	005 981 30 05
F 15076	
F 15082	001 981 99 05
F 15083	003 981 19 05
F 15083	003981190 (77...) ₅
F 15158	012 981 85 05
F 15159	006 981 35 05
F 19011	
F 19015	3459817501
F 19019	49815801
F 19046	
F 19047	
H 715345 / H 715311	0319811805
H 715345 / H 715311	181342
H 914841 / H 914811	
HM 212049 / HM 212011	
HM 807046 / HM 807010	031981190 (77...) ₅
HM 807049 / HM 807010	
HM 813841 / HM 813810	
JLM 714149 / JLM 714110	3459817118
JM 207049 / JM 207010	
JM 207049 A / JM 207010	
M 804049 / M 804010	
N 309 FM	
NJ 2206 FM	005412402216
NJ 2211 FM	000628000339
NJ 304 FM	005412400304
NJ 304 FMN	005412400304
NJ 305 C3	
NJ 305 FM / C3	005412400004
NU 208 FM	3459817101
NU 209 FMN	3449817101
NU 209 FMN	0019811701
NU 303 FM	0019819601

MERCEDES BENZ	
OEM	Fersa
006 981 35 05	F 15159
0069807205 / 0009807502	33111 F
007 981 2105	32012 XF
0079819005 / 00720032016	32016 XF
009 981 0905	33022 F
011 981 6905	32312 F
0119816805 / 0119816905	32312 F
012 981 4005	33116 F
012 981 85 05	F 15158
014 981 3205	33020 F
014 981 4405	32024 XF
031981190 (77...) ₅	HM 807046 / HM 807010
050 139 82 17	3382 / 3320
072 003 22 18	32218 F
073 537 00 55	F 15047
3411117121 / 3459817727	QJ 309 FM
3459817127 / 3459817727	QJ 309 FM
3849817605 / 0089810105	33208 F
7EQH1238	47686 / 47620
A0159813405	32208 F
A0159815005	32210 F
B5QM1216A / 9N4222	3782 / 3720
B7T1201A / E7HZ7K228A	25590 / 25522
LA5113	32208 F
LA5115	32210 F
	2789 / 2720
	6011
	6201 Z / C3
	6213 C3
	6216 C3
	6218 C3
	6304
	6309 Z / C3
	6311 C3
	6313 C3
	6314
	6403 2RS / C3
	25590 / 25520
	25877 / 25820
	30214 F
	30216 F
	30306 F
	31311 F
	32015 XF
	32205 BF
	32313 F
	33112 F
	33113 F
	33114 F
	33287 / 33462
	45284 / 45220
	47487 / 47420 A
	55200 C / 55437
	56425 / 56650
	72188 C / 72487
	72200 C / 72487

OEM REFERENCES LIST
 LISTA DE REFÊRENCIAS OEM
 LISTADO DE REFERENCIAS OEM

MERCEDES BENZ	
Fersa	OEM
NU 303 FM / C3	0019819601
NUP 206 FM	005412400004
NUP 212 FM	
NUP 2212 FMN	
NUP 310 FMN / C3	
NUP 311 FM	
NUP 311 FM / C3	0059815201
NUP 311 FMNR / C3	
NUP 314 FM	
NUP 314 FM / C3	0019809802
NUP 314 FM / C3	0019819802
NUP 314 FMNR / C3	001 981 98 02
QJ 208 FM	0009813427
QJ 209 FM	3459817027
QJ 212 FM	3459817627
QJ 309 FM	3411117121 / 3459817727
QJ 309 FM	3459817127 / 3459817727
QJ 309 FM	0009813105

SCANIA	
Fersa	OEM
482 / 472	
6004	144280
6007	140180
6007 C3	174668
6011 / C3	141930
6014 2RS	215139
6014 2RS / C3	1319737
6015 Z	
6201 2RS / C3	
6201 Z / C3	210998
6201 ZZ	
6202 2RS / C3	
6202 Z / C3	
6204	14089
6205	
6205 2RS	228836
6205 2RS	139246
6205 2RS / C3	2288365
6205 2RS / C3	14090
6205 C3	170727
6205 RS	
6207 C3	14091
6207 NR	132649
6208	
6211	14093
6212	14831
6215 C3	
6215 NR / C3	
62201 2RS / C3	
6303 2RS / C3	220137
6304	240288 / 152897
6304	14125

MERCEDES BENZ	
OEM	Fersa
	72218 C / 72487
	F 15076
	F 19011
	F 19046
	F 19047
	H 914841 / H 914811
	HM 212049 / HM 212011
	HM 807049 / HM 807010
	HM 813841 / HM 813810
	JM 207049 / JM 207010
	JM 207049 A / JM 207010
	M 804049 / 10
	N 309 FM
	NJ 305 C3
	NUP 212 FM
	NUP 2212 FMN
	NUP 310 FMN / C3
	NUP 311 FM
	NUP 311 FMNR / C3
	NUP 314 FM
	QJ 309 FM

SCANIA	
OEM	Fersa
14089	6204
14090	6205 2RS / C3
14091	6207 C3
14093	6211
14096	6309 ZNR / C3
14125	6304
14610	6307
14614	32306 F
14623	32309 F
14623	32312 F
14698	32308 F
14831	6212
14834	31309 F
14835	32218 F
14836	32309 F
14836	32312 F
33108	6305 2RS
33948	32219 F
123629	32316 F
123630	32220 F
132649	6207 NR
139246	6205 2RS
140180	6007
141930	6011 / C3
144280	6004
144710	32313 BF
168248	6305 2RS
170727	6205 C3
170793	6305 C3
174631	30217 F
174668	6007 C3
174716	31312 F

SCANIA	
Fersa	OEM
6304 C3	
6305	
6305 2RS	168248
6305 2RS	33108
6305 2RS / C3	258267
6305 2RS / C3	
6305 C3	170793
6307	14610
6309 NR / C3	
6309 ZNR / C3	14096
6311	
6311 NR / C3	
6312 C3	1304315
6403 2RS / C3	
6407 C3	
6409 C3	
6409 NR / C3	
6411 NR / C3	
30217 F	174717
30217 F	174631
30312 F	1523056
30314 F	
31309 F	14834
31312 F	174716
31312 F	7181609
31314 F	174961
32016 XF	1301682
32020 XF	274114
32020 XF	1364630
32021 XF	1415140
32022 XF	
32207 F	202635
32208 F	214104
32218 F	14835
32219 F	33948
32220 F	123630
32306 F	14614
32308 BF	1382900
32308 BF	322747
32308 F	14698
32309 F	14623
32309 F	14836
32311 F	179427
32312 F	14836
32312 F	14623
32313 BF	144710
32315 BF	194137
32316 F	123629
33017 F	1364631
33018 F	1309570
33208 F	284843
33212 F	345833
33212 F	345833
F 15046	194050
F 15047	0019801402
F 15048	315465

SCANIA	
OEM	Fersa
174717	30217 F
174961	31314 F
179427	32311 F
194050	F 15046
194137	32315 BF
202635	32207 F
210998	6201 Z / C3
214104	32208 F
215139	6014 2RS
220137	6303 2RS / C3
228836	6205 2RS
258267	6305 2RS / C3
264700	H 913842 / H 913810
274114	32020 XF
284843	33208 F
291060	HM 218248 / HM 218210
315465	F 15048
322747	32308 BF
345465	F 15048
345833	33212 F
345833	33212 F
361043	JF 4049 / JF 4010
374330	JF 5049 / JF 5010
380096	JF 4049 / JF 4010
383343	JF 10049 / 10
392996	JD 6549 / JD 6510
1105776	JM 720249 / 10
1301682	32016 XF
1304315	6312 C3
1309568	JHM 522649 / JHM 522610
1309569	F 19001
1309570	33018 F
1319737	6014 2RS / C3
1331313	F 19076
1364630	32020 XF
1364631	33017 F
1382900	32308 BF
1415140	32021 XF
1523056	30312 F
2288365	6205 2RS / C3
7181609	31312 F
0019801402	F 15047
0735410076	F 19010
0735410136	F 19039
240288 / 152897	6304
291060 / 1524625	HM 218248 / HM 218210
	482 / 472
	6015 Z
	6201 2RS / C3
	6201 ZZ
	6202 2RS / C3
	6202 Z / C3
	6205
	6205 RS
	6208
	6215 C3

OEM REFERENCES LIST
 LISTA DE REFÊRENCIAS OEM
 LISTADO DE REFERENCIAS OEM

SCANIA	
Fersa	OEM
F 15048	345465
F 15097	
F 19001	1309569
F 19010	0735410076
F 19039	0735410136
F 19076	1331313
H 913842 / H 913810	264700
HM 218248 / HM 218210	291060 / 1524625
HM 218248 / HM 218210	291060
JD 6549 / JD 6510	392996
JF 10049 / JF 10010	383343
JF 4049 / JF 4010	380096
JF 4049 / JF 4010	361043
JF 5049 / JF 5010	374330
JHM 522649 / JHM 522610	1309568
JLM 508748 / JLM 508710	
JM 716649 / JM 716610	
JM 720249 / JM 720210	1105776

SCANIA	
OEM	Fersa
	6215 NR / C3
	62201 2RS / C3
	6304 C3
	6305
	6309 NR / C3
	6311
	6311 NR / C3
	6403 2RS / C3
	6407 C3
	6409 C3
	6409 NR / C3
	6411 NR / C3
	30314 F
	32022 XF
	F 15097
	JLM 508748 / JLM 508710
	JM 716649 / JM 716610

STERLING	
Fersa	OEM
555 S / 552 A	
580 / 572	0039811405 /
594 A / 592 A	0039811405 / 183704
3782 / 3720	807949
6461A / 6420	
9278 / 9220	
64450 / 64700	
HM 212047 / HM 212011	C4TA1215B
HM 212049 / HM 212011	
JHM 720249 / JHM 720210	
JM 207049 A / JM 207011	

STERLING	
OEM	Fersa
807949	3782 / 3720
0039811405	580 / 572
0039811405 / 183704	594 A / 592 A
C4TA1215B	HM 212047 / HM 212011
	555 S / 552 A
	6461A / 6420
	9278 / 9220
	64450 / 64700
	HM 212049 / HM 212011
	JHM 720249 / JHM 720210
	JM 207049 A / JM 207011

SUDISA	
Fersa	OEM
368 S / 362	
387 A / 382 A	
388 A / 382	
580 / 572	39811405
594 A / 592 A	183704
594 A / 592 A	39811405
45291 / 45220	
HM 212049 / HM 212011	
HM 218248 / HM 218210	291060
HM 518445 / HM 518410	
LM 104949 / LM 104911	

SUDISA	
OEM	Fersa
183704	594 A / 592 A
291060	HM 218248 / HM 218210
39811405	580 / 572
39811405	594 A / 592 A
	368 S / 362
	387 A / 382 A
	388 A / 382
	45291 / 45220
	HM 212049 / HM 212011
	HM 518445 / HM 518410
	LM 104949 / LM 104911

VOLKSWAGEN	
Fersa	OEM
368 A / 362 A	2TA / 598319
368 A / 362 A	0915862 / 0915863
580 / 572	2S0598287B
580 / 572	2RH598313A
594 / 592 A	T12 / 501315A / 2S0598287B
594 A / 592 A	T12 / 501315A
594 A / 592 A	2S0598287B
3982 / 3920	2TA / 598313
3982 / 3920	2986549
6201 2RS / C3	2994207
6203	
6204 2RS C3	6,03201E+11
6303 2RS / C3	2994206
2780 / 2720	2686841
3585 / 3525	T13407637 / T13407628
3585 / 3525	T11 / 407628
3585 / 3525	T13407637 / T13407628 /
3585 / 3525	2RH498628
3782 / 3720	TMJ407628 2S0498625A
3782 / 3720	2S0498625A
3782 / 3720	TMJ407628
15106 / 15250 X	2TA / 498628A
15106 / 15250 X	2986545
25581 / 25520	
25590 / 25522	2TA / 498628
25590 / 25522	2986544
25877 / 25821	
30203 F	
30204 F	
33281 / 33462	2986596
33287 / 33462	TE3501285 / TE3501287
39581 / 39520	T13407632 / 119305
39581 / 39520	T11 / 501287
39581 / 39520	T13407632 / 119305 /
39581 / 39520	2S0498625A
39590 / 39520	T11 / 9360
39590 / 39520	T11 / 9360 / 2RH598313A
42381 / 42584	
45284 / 45220	2986840
47686 / 47620	T12 / 501315
HM 212049 / HM 212011	2RH / 498628
HM 212049 / HM 212011	2RH498628
HM 807040 / HM 807010	
HM 807046 / HM 807010	
JM 716649 / JM 716610	
LM 48548 / LM 48510	
M 12649 / M 12610	
M 802048 / M 802011	

VOLKSWAGEN	
OEM	Fersa
2686841	2780 / 2720
2986544	25590 / 25522
2986545	15106 / 15250 X
2986549	3982 / 3920
2986596	33281 / 33462
2986840	45284 / 45220
2994206	6303 2RS / C3
2994207	6201 2RS / C3
6,03201E+11	6204 2RS C3
0915862 / 0915863	368 A / 362 A
2RH / 498628	HM 212049 / HM 212011
2RH498628	3585 / 3525
2RH498628	HM 212049 / HM 212011
2RH598313A	580 / 572
2S0498625A	3782 / 3720
2S0498625A	39581 / 39520
2S0598287B	580 / 572
2S0598287B	594 A / 592 A
2TA / 498628	25590 / 25522
2TA / 498628A	15106 / 15250 X
2TA / 598313	3982 / 3920
2TA / 598319	368 A / 362 A
T11 / 407628	3585 / 3525
T11 / 501287	39581 / 39520
T11 / 9360	39590 / 39520
T11 / 9360 / 2RH598313A	39590 / 39520
T12 / 501315	47686 / 47620
T12 / 501315A	594 A / 592 A
T12 / 501315A / 2S0598287B	594 / 592 A
T13407632 / 119305	39581 / 39520
T13407632 / 119305 /	39581 / 39520
T13407637 / T13407628	3585 / 3525
T13407637 / T13407628 /	3585 / 3525
TE3501285 / TE3501287	33287 / 33462
TMJ407628	3782 / 3720
TMJ407628 2S0498625A	3782 / 3720
	6203
	25581 / 25520
	25877 / 25821
	30203 F
	30204 F
	42381 / 42584
	HM 807040 / HM 807010
	HM 807046 / HM 807010
	JM 716649 / JM 716610
	LM 48548 / LM 48510
	M 12649 / M 12610
	M 802048 / M 802011



OEM REFERENCES LIST
 LISTA DE REFÊRENCIAS OEM
 LISTADO DE REFERENCIAS OEM

VOLVO	
Fersa	OEM
537 / 532 X	
555 S / 552 A	
580 / 572	003 981 14 05
580 / 572	184728 / 181128
594 / 592	
594 / 592 A	181298
594 / 592 A	183704
594 / 592 A	181299 / 181125
594 A / 592 A	183704
663 / 653	6889594
683 / 672	181596 / 181279
683 / 672	6889593
687 / 672	181596 / 181279
687 / 672	184637
3206 B	181286
3207 B 2RS / C3	181577
3782 / 3720	807949
30214 F	
30217 F	184459
30306 F	001 981 71 05
31308 F	6782631
31312 F	181609
31315 F	181396
32015 XF	
32017 XF	184623
32213 F	11076
32218 F	
32219 F	181086
32310 F	11062
33110 F	184649
33208 F	184679
33212 F	1652563
39580 / 39520	184088
6005 2RS	183502
6006 2RS	
6009 C3	183234
6014	
6014 C3	19278
6201 2RS / C3	183379
6201 ZZ / C3	240453
6202 2RS	1660609
6206	11013
6206 2RS	11013
6206 2RS	181538
6206 2RS	1544092
6208 N	184646
62201 2RS / C3	244328
6303 2RS / C3	183486
6303 2RS / C3	6885190 (77...)
6304	11022
6304 2RS	181826
6310	11028
6386 / 6320	
6461A / 6420	
F 15047	0019801402
F 15071	

VOLVO	
OEM	Fersa
11013	6206
11013	6206 2RS
11022	6304
11028	6310
11062	32310 F
11076	32213 F
19278	6014 C3
181086	32219 F
181286	3206 B
181298	594 / 592 A
181396	31315 F
181538	6206 2RS
181577	3207 B 2RS / C3
181609	31312 F
181826	6304 2RS
183234	6009 C3
183379	6201 2RS / C3
183486	6303 2RS / C3
183502	6005 2RS
183703	NUP 2212 F
183704	594 / 592 A
183704	594 A / 592 A
184088	39580 / 39520
184459	30217 F
184623	32017 XF
184633	HM 911245 / HM 911210
184634	H 913842 / H 913810
184635	H 913842 / H 913810
184637	687 / 672
184646	6208 N
184649	33110 F
184679	33208 F
240453	6201ZR / C3
244328	62201 2RS / C3
291060	HM 218248 / HM 218210
807949	3782 / 3720
1523243	NJ 2309 F / C3
1544092	6206 2RS
1652563	33212 F
1660609	6202 2RS
1842870	NU 206 FM
6782631	31308 F
6889593	683 / 672
6889594	663 / 653
0019801402	F 15047
20967831	F 200001 A
21036050	F 200002 A
001 981 71 05	30306 F
003 981 14 05	580 / 572
181299 / 181125	594 / 592 A
181596 / 181279	683 / 672
181596 / 181279	687 / 672
184728 / 181128	580 / 572
2RH / 498628	HM 212049 / HM 212011
6885190 (77...)	6303 2RS / C3
C4TA1215B	HM 212047 / HM 212011

Cross References

Cruzamento de Refêrencias

Cruce de Referencias

10.9

Fersa®	FAG						
1380 / 1328	K1380.1328	30212 F	30212A	32219 F	32219A	34306 / 34478	K34306.34478
11590 / 11520	K11590.11520	30217 F	30217A	32220 F	32220A	39250 / 39412	K39250.39412
12168 / 12303	K12168.12303	30220 F	30220A	32304 F	32304A	39580 / 39520	K39580.39520
12175 / 12303	K12175.12303	30302 F	30302A	32305 F	32305A	39581 / 39520	K39581.39520
14116 / 14276	K14116.14276	30304 F	30304A	32306 F	32306A	39581 / 45220	K39581.45220
15101 / 15245	K15101.15245	30305 F	30305A	32307 F	32307A	39590 / 39520	K39520.39590
15103S / 15243	K15103S.15243	30306 F	30306A	32308 BF	32308B.W10B	39590 / 39520	K39590.39520
15106 / 15250 X	K15106.15250X	30307 F	30307A	32308 F	32308A	469 / 453	K469.453
15106 / 15250X	K15106.15250X	30308 F	30308A.TVP	32309 F	32309A	469 / 453 X	K469.453X.J42B
2689 / 2631	K2689.2631. J42B	30308 F	30308A	32310 F	32310A	469 / 453 X	K469.453X
2780 / 2720	K2780.2720	30309 F	30309A	32312 F	32312A	495 A / 493	K495A.493
2789 / 2720	K2789.2720	30312 F	30312A	32313 BF	32313 BA	495 AX / 493	K495AX.493
25580 / 25520	K25580.25520	30313 F	30313A	32313 F	32313 BA	496 / 493	K496.493
25590 / 25520	K25590.25520	30314 F	30314A	32314 BF	32314 BA	497 / 492 A	K497.492A
25590 / 25522	K25590.25522	31308 F	31308A	32314 BF	32314BA.E30	497 / 493	K497.493
25877 / 25820	K25877.25820	31309 F	31309A	32315 BF	32315B	498 / 492 A	K498.492A
25877 / 25821	AK25877.25821	31312 F	31312A	32316 F	32316A	498 / 493	K498.493
25877 / 25821	K25877.25821	31313 F	31313A	33011 F	33011	498 A / 492 A	K498A.492A
25880 / 25820	K25880.25820	31314 F	31314A	33017 F	33017	42346 / 42584	K42346.42584
29675 / 29630	K29675.29630	31315 F	31315	33018 F	33018	42350 / 42384	K42350.42384
29685 / 29620	K29685.29620	31594 / 31520	K31594.31520	33019 F	33019	42368 / 42584	K42368.42584
368 A / 362 A	805274 (K368A.362A)	31597 / 31520	K31597.31520	33020 F	33020	42381 / 42584	K42381.42584
368 S / 362	K368S.362	32008 XF	32008XA	33020 F	33020A	42584 / 42381	K42584.42381
387 / 382 A	K387.382A	32009 XF	32009XA	33021 F	33021	42688 / 42620	K42688.42620
387 A / 382 A	K387A.382A	32010 XF	32010X	33022 F	33022	45284 / 45220	K45284.45220
387 A / 382 S	K387A.382S	32011 XF	32011X	33022 F	33022A	45284 / 45220	K45284. LM45220
387 AS / 382 A	K387AS.382A	32012 XF	32012X	33109 F	33109	45291 / 45220	K45291.45220
388 A / 382	K388A.382	32014 XF	32014X	33110 F	33110	47686 / 47620	K47686.47620
3196 / 3120	K3196.3120	32015 XF	32015X	33111 F	33111	47686 / 47620	AK47686.47620
3206 B	3206B.TVH	32016 XF	32016X	33112 F	33112	47890 / 47820	K47890.47820
3207 B	3207B.TVH	32017 XF	32017X	33115 F	33115	49585 / 49520	K49585.49520
3382 / 3320	K3382.3320	32017 XF	32017	33116 F	33116	537 / 532 X	K537.532X
3585 / 3525	K3585.3525	32018 XF	32018XA	33117 F	33117	555 S / 552 A	K555S.552A
3586 / 3525	K3586.3525	32018 XF	32018 XA	33117 F	33117A	559 / 552 A	K559.552A
3767 / 372	K3767.372	32019 XF	32019XA	33205 F	33205	567 / 563	K567.563
3780 / 3720	K3780.3720	32020 XF	30020X	33207 F	33207	580 / 572	K580.572
3782 / 3720	K3782.3720	32020 XF	32020X	33208 F	33208	581 / 572	K581.572
3982 / 3920	K3982.3920	32021 XF	32021X	33209 F	33209	594 / 592 A	K594.592A
3984 / 3920	K3984.3920	32022 XF	32022X	33210 F	33210	594 / 592A	K594.592A
3994 / 3920	K3994.3920	32024 XF	32024X	33212 F	33212	594 A / 592 A	K594A.592A
30203 F	30203A.TVP	32205 F	32205A	33213 F	33213	594 A / 592 A	K594A.592A
30204 F	30204A	32206 F	32206A	33214 F	33214	598 A / 592 A	K598A.592A
30205 F	30205A	32207 F	32207A	33215 F	33215	598 A / 593 X	K598A.593X
30206 F	30206A	32208 F	32208A	33275 / 33472	K33275.33472	52400 / 52618	K52400.52618
30207 F	30207A	32210 F	32210A	33281 / 33462	K33281.33462	55200 C / 55437	K55200C.55437
30208 F	30208A	32212 F	32212A	33287 / 33462	K33287.33462	55200 C / 55437	K55200.55437
30208 F	30208 A	32213 F	32213 A	33885 / 33822	K33885.33822	55206 C / 55437	K55206C.55437
30209 F	30209A	32213 F	32213A	33889 / 33822	K33889.33822	56425 / 56650	K56425.56650
30210 F	30210A	32214 F	32214 A	33889 / 33882	K33889.33882	59162 / 59412	K59175.59412
		32214 F	32214A	33895 / 33821	K33895.33821	59175 / 59412	K59175.59412
		32216 F	32216A	33895 / 33822	K33895.33822	641 / 632	K641.632
		32218 F	32218A	34274 / 34492 A	K34274.34492A		

663 / 653	K663.653	6203 Z	6203ZR	6303 2RS / C3	6303.2RSR.C3	6408	6408
681 A / 672	K681A.672	6203 ZZ	6203.2ZR	6303 2RS / C3	6303-2RSH/ C3HT	6461A / 6420	K6461A.6420
683 / 672	K683.672	6204	6204	6303 2RS/C3	6303.2RSR.C3	62201 2RS / C3	62201.2RSR.C3
687 / 672	K687.672	6204 2RS	6204.2RSR	6303 RS / C3	6303 RSR.C3	62202 2RS / C3	62202.2RSR.C3
6004	6004	6204 2RS / C3	6204.2RSR.C3	6303 RS / C3	6303.2RSR.C3	62204 2RS	62204.2RSR
6004 2RS	6004.2RSR	6204 Z	6204ZR	6303 RS/C3	6303RSR.C3	62302 2RS / C3	62302.2RSR.C3
6005 2RS	6005.2RSR	6204 ZZ	6204.2ZR	6303 Z	6303ZR	63006 2RS / C4	63006.2RSR.C4
6006	6006	6205	6205	6303 Z / C3	6303.2ZR.C3	64450 / 64700	K64450.64700
6006 2RS	6006.2RSR	6205 2RS	6205.2RSR	6303 Z / C3	6303ZR.C3	65237 / 65500	K65237.65500
6007	6007	6205 2RS / C3	6205.2RSR.C3	6303 ZZ	6303.2ZR	66225 / 66462	K66225.66462
6007 2RS	6007.2RSR	6205 C3	6205/C3	6303 ZZ / C3	6303 ZR.C3	68450 / 68712	K68450.68712
6007 C3	6007/C3	6205 Z	6205 Z	6303 ZZ / C3	6303.2ZR.C3	68462 / 68712	K68462.68712
6007 N	6007 N	6205 ZZ	6205.2ZR	6304 2RS	6304.2RSR	749 / 742	K749.742
6008	6008	6206	6206	6304 2RS / C3	6304.2RSR.C3	760 / 752	K760.752
6008 2RS	6008.2RSR	6206 2RS	6206.2RSR	6304 2RS / C3	6304.2RSR.C3	72188 C / 72487	K72188C.72487
6008 Z	6008ZR	6206 2RS / C3	6206.2RSR.C3	6304 2RS / C4	6304.2RSR.TNH. C4	72200 C / 72487	K72200C.72487
6009	6009	6206 2RS / C3	6206-2RS1/C3	6304	6304	72212 C / 72487	K72212C.72487
6009 2RS	6009.2RSR	6206 2RS / C4	6206.2RSR.C4	6304 ZZ	6304.2ZR	72218 C / 72487	K72218C.72487
6009 C3	6009.C3	6206 C3	6206/C3	6304 C3	6304.C3	78215 C / 78551	K78215C.78551
6009 NR	6009NR	6206 NR 2RS	6206.2RSR.NR	6305	6305	78225 C / 78551	K78225C.78551
6010	6010	6206 Z	6206ZR	6305 / C3	6305.C3	78225 C / 78551	K78225C.78551. J42B
6010 2RS	6010.2RSR	6206 ZZ	6206.2ZR	6305 2RS	6305.2RSR	9278 / 9220	K9278.9220
6010 Z	6010ZR	6206 ZZ / C3	6206.2ZR.C3	6305 2RS / C3	6305.2RSR.C3	F 15036	540484A
6011	6011	6207	6207	6305 C3	6305/C3	F 15041	546467
6011 / C3	6011.C3	6207 2RS	6207.2RSR	6306	6306	F 15043	803837A.E30
6011 ZZ	6011.2ZR	6207 C3	6207/C3	6306 / C3	6306.C3	F 15046	521471A
6013	6013	6207 NR	6207 NR	6306 2RS	6306.2RSR	F 15047	522380
6014 2RS	6014.2RSR	6207 NR 2RS	6207.2RSR.NR	6306 NR	6306NR	F 15048	543562
6014 2RS / C4	6014.2RSR. C4.L198	6207 Z	6207ZR	6306 ZZ	6306.2ZR	F 15051 C	534565
6014 C3	6014.C3	6207 ZZ	6207.2ZR	6307	6307	F 15082	509333A
6200 2RS	6200.2RSR	6208	6208	6307 / C3	6307.C3	F 15083	521618
6200 2RS / C3	6200.2RSR.C3	6208 2RS	6208.2RSR	6307 2RS	6307.2RSR	F 15128	SAM0012
6200 2RSR / C3	6200.2RSR.C3	6208 N	6208 N	6307 NR	6307NR	F 15141	530689 B
6201 2RS / C3	6201.2RSR.C3	6208 N	6208 NR	6307 RS	6307RSR	F 15156	804358
6201 2RS/C3	6201.2RSR.C3	6208 ZZ	6208.2ZR	6307 Z	6307ZR	F 15158	562830A
6201 N 2RS / C3	6201-2RSH/ C3GJN	6209	6209	6307 ZNR	6307 ZRNR	F 15159	575725.F51
6201 RS / C3	6201RSR.C3	6209 2RS	6209.2RSR	6308	6308	F 15165	548866
6201 Z	6201ZR	6209 C3	6209/C3	6308 2RS	6308.2RSR	F 15175	SAM0009
6201 Z / C3	6201ZR.C3	6209 NR	6209NR	6308 N	6308 N	F 15183	540669
6201 ZZ / C3	6201ZR.C3	6209 NR / C3	6209NR.C3	6308 NR	6308 NR	F 16013	579794DA
6201 ZZ / C3	6201.2ZR.C3	6210 2RS	6210.2RSR	6308 NR / C4	6308NR.C4	F 16019	540466B
6201ZR / C3	6201ZR.C3	6210	6210	6308 ZNR	6308 ZRNR	F 16023	544307C
6202	6202	6210 Z	6210ZR	6308 ZNR / C3	6308 ZRN.C3	F 16026	548083
6202 C3	6202.C3	6210 ZZ	6210.2ZR	6309	6309	F 16028	561447
6202 2RS	6202.2RSR	6211	6211	6309 2RS	6309.2RSR	F 16032	541521C
6202 2RS / C3	6202RSR.C3	6211 2RS	6211.2RSR	6309 NR	6309 NR	F 16032	541521CA
6202 2RS / C3	6202.2RSR.C3	6211 C3	6211/C3	6309 ZNR / C3	6309ZRNR.C3	F 16039	566719DA
6202 Z	6202 ZR	6211 N / C3	6211 N/C3	6310	6310	F 16040	801136
6202 Z / C3	6202ZR.C3	6211 Z	6211ZR	6310 2RS	6310.2RSR	F 16052	SA0030
6202 ZZ	6202 2ZR	6211 ZNR	6211ZRNR	6310 C3	6310/C3	F 16065	800179D
6202 ZZ / C3	6202ZR.C3	6212	6212	6311 C3	6311.C3	F 16078	SA0006
6203	6203	6212 2RS	6212.2RSR	6312 C3	6312.C3	F 16081	SA0009
6203 2RS	6203.2ZR	6212 NR	6212NR	6312 C3	6312.C3	F 16083	803775
6203 2RS	6203.2RSR	6302	6302	6314 C3	6314N.C3	F 16196	SA0060
6203 2RS / C3	6303.2RSR.C3	6302 2RS / C3	6302.2RSR.C3	6314 N / C3	6314N.C3	F 16197	SA0057
6203 2RS / C3	6203.2RSR.C3	6302 Z	6302ZR	6386 / 6320	K6386.6320	F 16198	SA0032
6203 C3	6203.C3	6303	6303	6403 2RS / C3	6403.2RSR.C3	F 16199	SA0028
		6303 2RS	6303.2RSR	6403 2RS / C3	6403.C3	F 18021	566195
				6403 C3	6403.C3		

CROSS REFERENCES
 CRUZAMENTO DE REFERÊNCIAS
 CRUCE DE REFERENCIAS

Fersa - FAG

F 18024	536906C	HM 804843 / HM 804810	KHM804843. HM804810	KA 069	WBK0002	NJ 304 FMN	NJ304EN.TVP2
F 19001	805262	HM 804846 / HM 804810	KHM804846.10	KA 075	WBK0001	NJ 305 FM / C3	NJ305E.TVP2.C3
F 19008	566616 B	HM 804846 / HM 804810	KHM804846.	KA 273	WBK0007	NJ 309 FM	NJ309E.TVP2
F 19009	540106	HM 807040 / HM 807010	KHM807040.10	KF 145	F-561166	NJ 309 FM / C3	NJ309E.TVP2.C3
F 19010	805449	HM 807040 / HM 807010	KHM807040.	KV 164	WBK0008	NJ 309 FP / C3	NJ309E.TVP2.C3
F 19012	510148 A	HM 807046 / HM 807010	KHM807046.10	L 44649 / L 44610	KL44649.L44610	NU 206 FM	NU206E.TVP2
F 19015	F-45814	HM 807046 / HM 807010	KHM807046.	L 45449 / L 45410	518772A	NU 208 FM	NU208EN.TN
F 19019	512533	HM 807046 / HM 807010	KHM807046.10	LM 11749 / LM 11710	KLM11749. LM11710	NU 209 FMN	NU209EN.TVP2
F 19034	MU 1308UM	HM 807046 / HM 807010	KHM807046.	LM 11949 / LM 11910	KLM11949. LM11910	NU 303 FM	NU303E.TVP2
F 19039	805450	HM 807049 / HM 807010	KHM807049.10	LM 11949 / LM11910	KLM11949. LM11910	NU 310 FM / C3	NU310E.TVP2.C3
F 19042	804339	HM 813841 / HM 813810	KHM813841.10	M 12649 / M 12610	KM12649. M12610	NUP 206 FM	NUP206
F 19076	580989	HM 813842 / HM 813810	KHM813842. HM813810	LM 102949 / LM 102910	KLM102949.10	NUP 2205	NUP2205E.TVP2
F 200001 A	566426.H195	HM 813843 / HM 813810	KHM813843.10	LM 104949 / LM 104910	KLM104949.10	NUP 2212 F	NUP2212E.TVP2
F 200002 A	566425.H195	HM 903249 / HM 903210	KHM903249.10	LM 104949 / LM 104911	KLM104949.11	NUP 2212 FMN	NUP2212E.804339
H 715334 / H 715311	KH715334.11	HM 911245 / HM 911210	KHM911245. HM911210	LM 104949 / LM 104912	KLM104949.12	NUP 309 FM	NUP309E.TVP
H 715343 / H 715311	KH715343.11	JD 6549 / JD 6510	T2DD065	LM 29749 / LM 29710	KLM29749. LM29710	NUP 309 FM / C3	NUP309E.TVP.C3
H 715345 / H 715311	KH715345.11	JF 4049 / JF 4010	T2EE040	LM 29749 / LM 29711	KLM29749. LM29711	NUP 310 FMN / C3	NUP310EJP3.C3
H 715345 / H 715311	KH715345. H715311	JF 5049 / JF 5010	T2ED050	LM 300849 / LM 300811	KLM300849. LM300811	NUP 311 FM / C3	NUP311EN.M1.C3
H 913842 / H 913810	KH913842. H913810	JF 10049 / JF 10010	T2EE100	LM 48548 / LM 48510	KLM48548. LM48510	NUP 314 FM / C3	NUP314EN.M1.C3
H 913842 / H 913810	KH913843.913810	JH 211749 / JH 211710	KJH211749.10	LM 48548 / LM48510	KLM48548. LM48510	NUP 314 FMNR / C3	NUP314EN.M1.C3
H 913842 / H 913810	KH913842.913810	JHM 522649 / JHM 522610	KJHM522649. JHM522610	LM 501349 / LM 501310	KLM501349. LM501310	QJ 208 FM	QJ208.TVP. A50.80
H 914841 / H 914811	KH914841.11	JHM 720249 / JHM 720210	KJHM720249.10	LM 503349 A / LM 503310	KLM503349A. LM503310	QJ 209 FM	QJ209TNH. A50.80
HM 212044 / HM 212011	KHM212044.11	JLM 104946 / JLM 104911 A	KJLM104946.11A	LM 603049 / LM603011	KLM603049. LM603011	QJ 212 FM	QJ212TVP.E30. T42A
HM 212047 / HM 212011	KHM212047.11	JLM 710949 / JLM 710910	KJLM710949.10	LM 67048 / LM 67010	KLM67048. LM67010	QJ 309 FM	QJ309TNH. A50.80
HM 212047 / HM 212011	KHM212047. HM212011	JLM 710949 C / JLM 710910	KJLM710949C.10	LM 78349 / LM 78310	KLM78349. LM78310TVP	T 163	F-45953
HM 212047 / HM 212011	KHM212049. HM212011	JLM 714149 / JLM 714110	KJLM714149.10	LM 806649 / LM 806610	KLM806649. LM806610	T 182	F-45954
HM 212049 / HM 212011	KHM212049.11	JM 207049 / JM 207010	KJM207049.10	M 88043 / M 88010	KM88043. M88010		
HM 212049 / HM 212011	KHM212049. HM212011	JM 207049 A / JM 207010	KJM207049A.10	M 88048 / M 88010	KM88048.10		
HM 212049 / HM 212011	KHM212047. HM212011	JM 207049 A / JM 207011	KJM207049A.11	M 802048 / M 802011	KM802048. M802011		
HM 218248 / HM 218210	KHM218248. HM218210	JM 511946 / JM 511910	KJM511946.10	M 804049 / M 804010	KM804049.10		
HM 218248 / HM 218210	KHM218248.10	JM 714249 / JM 714210	KJM714249. JM714210	N 207 / C3	N207E.TN.C3		
HM 218248 / HM 218210	K218248.10	JM 716649 / JM 716610	KJM716649.10	N 221 FMNR / C3	N2211ENR. MI.C3		
HM 220149 / HM 220110	KHM220149. HM220110	JM 720249 / JM 720210	KJM720249.10	N 309 FM	N309E.M1		
HM 516449 / HM 516410	KHM516449.10	KA 019	WBK0006	NJ 205 / C3	NJ205E.TVP2.C3		
HM 518445 / HM 518410	KHM518445.10	KA 021	WBK0005	NJ 206	NJ206E.TVP2		
HM 88542 / HM 88510	KHM88542.10	KA 038	WBK0003	NJ 2206 FM	NJ2206E.TVP2		
HM 89443 / HM 89411	KHM89443.11	KA 040	WBK0004	NJ 2211 FM	NJ2211E.M1		
HM 803145 / HM 803110	KHM803145. HM803110			NJ 2309 FM / C3	NJ2309E.TVP2.C3		
HM 803146 / HM 803110	KHM803146. HM803110			NJ 304 FM	NJ304EN.TVP2		
HM 803149 / HM 803110	KHM803149.10						

FAG	Fersa®
30020X	32020 XF
30203A.TVP	30203 F
30204A	30204 F
30205A	30205 F
30206A	30206 F
30207A	30207 F
30208 A	30208 F
30208A	30208 F
30209A	30209 F
30210A	30210 F
30212A	30212 F
30217A	30217 F
30220A	30220 F
30302A	30302 F
30304A	30304 F
30305A	30305 F
30306A	30306 F
30307A	30307 F
30308A	30308 F
30308A.TVP	30308 F
30309A	30309 F
30312A	30312 F
30313A	30313 F
30314A	30314 F
31308A	31308 F
31309A	31309 F
31312A	31312 F
31313A	31313 F

31314A	31314 F	33110	33110 F	6008ZR	6008 Z	6206.2ZR	6206 ZZ
31315	31315 F	33111	33111 F	6009.2RSR	6009 2RS	6206.2ZR.C3	6206 ZZ / C3
32008XA	32008 XF	33112	33112 F	6009.C3	6009 C3	6206/C3	6206 C3
32009XA	32009 XF	33115	33115 F	6009	6009	6206-2RS1/C3	6206 2RS / C3
32010X	32010 XF	33116	33116 F	6009NR	6009 NR	6206	6206
32011X	32011 XF	33117	33117 F	6010.2RSR	6010 2RS	6206ZR	6206 Z
32012X	32012 XF	33117A	33117 F	6010	6010	6207 NR	6207 NR
32014X	32014 XF	33205	33205 F	6010ZR	6010 Z	6207.2RSR	6207 2RS
32015X	32015 XF	33207	33207 F	6011.2ZR	6011 ZZ	6207.2RSR.NR	6207 NR 2RS
32016X	32016 XF	33208	33208 F	6011.C3	6011 / C3	6207.2ZR	6207 ZZ
32017	32017 XF	33209	33209 F	6011	6011	6207/C3	6207 C3
32017X	32017 XF	33210	33210 F	6013	6013	6207	6207
32018 XA	32018 XF	33212	33212 F	6014.2RSR	6014 2RS	6207ZR	6207 Z
32018XA	32018 XF	33213	33213 F	6014.2RSR.	6014 2RS / C4	6208 N	6208 N
32019XA	32019 XF	33214	33214 F	C4.L198	6014 2RS / C4	6208 NR	6208 N
32020X	32020 XF	33215	33215 F	6014.C3	6014 C3	6208.2RSR	6208 2RS
32021X	32021 XF	509333A	F 15082	6200.2RSR	6200 2RS	6208.2ZR	6208 ZZ
32022X	32022 XF	510148 A	F 19012	6200.2RSR.C3	6200 2RS / C3	6208	6208
32024X	32024 XF	512533	F 19019	6200.2RSR.C3	6200 2RSR / C3	6209.2RSR	6209 2RS
3206B.TVH	3206 B	518772A	L 45449 /	6201.2RSR.C3	6201 2RS / C3	6209/C3	6209 C3
3207B.TVH	3207 B		L 45410	6201.2RSR.C3	6201 2RS/C3	6209	6209
32205A	32205 F	521471A	F 15046	6201.2ZR.C3	6201 ZZ / C3	6209NR	6209 NR
32206A	32206 F	521618	F 15083	6201-2RSH/	6201 N 2RS / C3	6209NR.C3	6209 NR / C3
32207A	32207 F	522380	F 15047	C3GJN		6210.2RSR	6210 2RS
32208A	32208 F	530689 B	F 15141	6201RSR.C3	6201 RS / C3	6210.2ZR	6210 ZZ
32210A	32210 F	534565	F 15051 C	6201ZR	6201 Z	6210	6210
32212A	32212 F	536906C	F 18024	6201ZR.C3	6201 Z / C3	6210ZR	6210 Z
32213 A	32213 F	540106	F 19009	6201ZR.C3	6201 ZZ / C3	6211 N/C3	6211 N / C3
32213A	32213 F	540466B	F 16019	6201ZR.C3	6201ZR / C3	6211.2RSR	6211 2RS
32214 A	32214 F	540484A	F 15036	6202 2ZR	6202 ZZ	6211/C3	6211 C3
32214A	32214 F	540669	F 15183	6202 ZR	6202 Z	6211	6211
32216A	32216 F	541521C	F 16032	6202.2RSR	6202 2RS	6211ZR	6211 Z
32218A	32218 F	541521CA	F 16032	6202.2RSR.C3	6202 2RS / C3	6211ZNR	6211 ZNR
32219A	32219 F	543562	F 15048	6202.C3	6202 C3	6212.2RSR	6212 2RS
32220A	32220 F	544307C	F 16023	6202	6202	6212	6212
32304A	32304 F	546467	F 15041	6202RSR.C3	6202 2RS / C3	6212NR	6212 NR
32305A	32305 F	548083	F 16026	6202ZR.C3	6202 Z / C3	62201.2RSR.C3	62201 2RS / C3
32306A	32306 F	548866	F 15165	6202ZR.C3	6202 ZZ / C3	62202.2RSR.C3	62202 2RS / C3
32307A	32307 F	561447	F 16028	6203.2RSR	6203 2RS	62204.2RSR	62204 2RS
32308A	32308 F	562830A	F 15158	6203.2RSR.C3	6203 2RS / C3	62302.2RSR.C3	62302 2RS / C3
32308B.W10B	32308 BF	566195	F 18021	6203.2ZR	6203 2RS	63006.2RSR.C4	63006 2RS / C4
32309A	32309 F	566425.H195	F 200002 A	6203.2ZR	6203 ZZ	6302.2RSR.C3	6302 2RS / C3
32310A	32310 F	566426.H195	F 200001 A	6203.C3	6203 C3	6302	6302
32312A	32312 F	566616 B	F 19008	6203	6203	6302ZR	6302 Z
32313 BA	32313 BF	566719DA	F 16039	6203ZR	6203 Z	6303 RSR.C3	6303 RS / C3
32313 BA	32313 F	575725.F51	F 15159	6204.2RSR	6204 2RS	6303 ZR.C3	6303 ZZ / C3
32314 BA	32314 BF	579794DA	F 16013	6204.2RSR.C3	6204 2RS / C3	6303.2RSR	6303 2RS
32314BA.E30	32314 BF	580989	F 19076	6204.2ZR	6204 ZZ	6303.2RSR.C3	6203 2RS / C3
32315B	32315 BF	6004.2RSR	6004 2RS	6204	6204	6303.2RSR.C3	6303 2RS / C3
32316A	32316 F	6004	6004	6204ZR	6204 Z	6303.2RSR.C3	6303 2RS/C3
33011	33011 F	6005.2RSR	6005 2RS	6205 Z	6205 Z	6303.2RSR.C3	6303 RS / C3
33017	33017 F	6006.2RSR	6006 2RS	6205 2RSR	6205 2RS	6303.2ZR	6303 ZZ
33018	33018 F	6006	6006	6205.2RSR.C3	6205 2RS / C3	6303.2ZR.C3	6303 Z / C3
33019	33019 F	6007 N	6007 N	6205.2ZR	6205 ZZ	6303.2ZR.C3	6303 ZZ / C3
33020	33020 F	6007.2RSR	6007 2RS	6205/C3	6205 C3	6303-2RSH/	6303 2RS / C3
33020A	33020 F	6007/C3	6007 C3	6205	6205	C3HT	
33021	33021 F	6007	6007	6206.2RSR	6206 2RS	6303	6303
33022	33022 F	6008.2RSR	6008 2RS	6206.2RSR.C3	6206 2RS / C3	6303RSR.C3	6303 RS/C3
33022A	33022 F	6008	6008	6206.2RSR.C4	6206 2RS / C4	6303ZR	6303 Z
33109	33109 F			6206.2RSR.NR	6206 NR 2RS		

CROSS REFERENCES
 CRUZAMENTO DE REFERÊNCIAS
 CRUCE DE REFERENCIAS

FAG - Fersa

6206.2ZR	6206 ZZ	6303ZR.C3	6303 Z / C3	AK47686.47620	47686 / 47620	K3984.3920	3984 / 3920
6206.2ZR.C3	6206 ZZ / C3	6304.2RSR	6304 2RS	F-45814	F 19015	K3994.3920	3994 / 3920
6206/C3	6206 C3	6304.2RSR.C3	6304 2RS / C3	F-45953	T 163	K42346.42584	42346 / 42584
6206-2RS1/C3	6206 2RS / C3	6304.2RSR.TNH.C4	6304 2RS / C4	F-45954	T 182	K42350.42384	42350 / 42384
6206	6206	6304.2ZR	6304 ZZ	F-561166	KF 145	K42368.42584	42368 / 42584
6206ZR	6206 Z	6304.C3	6304 C3	K11590.11520	11590 / 11520	K42381.42584	42381 / 42584
6207 NR	6207 NR	6304	6304	K12168.12303	12168 / 12303	K42584.42381	42584 / 42381
6207.2RSR	6207 2RS	6305.2RSR	6305 2RS	K12175.12303	12175 / 12303	K42688.42620	42688 / 42620
6207.2RSR.NR	6207 NR 2RS	6305.2RSR.C3	6305 2RS / C3	K1380.1328	1380 / 1328	K45284.45220	45284 / 45220
6207.2ZR	6207 ZZ	6305.C3	6305 / C3	K14116.14276	14116 / 14276	K45284.	45284 / 45220
6207/C3	6207 C3	6305/C3	6305 C3	K15101.15245	15101 / 15245	LM45220	45284 / 45220
6207	6207	6305	6305	K15103S.15243	15103S / 15243	K45291.45220	45291 / 45220
6207ZR	6207 Z	6306.2RSR	6306 2RS	K15106.15250X	15106 / 15250 X	K469.453	469 / 453
6208 N	6208 N	6306.2ZR	6306 ZZ	K15106.15250X	15106 / 15250X	K469.453X	469 / 453 X
6208 NR	6208 N	6306.C3	6306 / C3	K218248.10	HM 218248 / 10	K469.453X.J42B	469 / 453 X
6208.2RSR	6208 2RS	6306	6306	K25580.25520	25580 / 25520	K47686.47620	47686 / 47620
6208.2ZR	6208 ZZ	6306NR	6306 NR	K25590.25520	25590 / 25520	K47890.47820	47890 / 47820
6208	6208	6307 ZRNR	6307 ZNR	K25590.25522	25590 / 25522	K49585.49520	49585 / 49520
6209.2RSR	6209 2RS	6307.2RSR	6307 2RS	K25877.25820	25877 / 25820	K495A.493	495 A / 493
6209/C3	6209 C3	6307.C3	6307 / C3	K25877.25821	25877 / 25821	K495AX.493	495 AX / 493
6209	6209	6307	6307	K25880.25820	25880 / 25820	K496.493	496 / 493
6209NR	6209 NR	6307NR	6307 NR	K2689.2631.	2689 / 2631	K497.492A	497 / 492 A
6209NR.C3	6209 NR / C3	6307RSR	6307 RS	J42B	2689 / 2631	K497.493	497 / 493
6210.2RSR	6210 2RS	6307ZR	6307 Z	K2780.2720	2780 / 2720	K498.492A	498 / 492 A
6210.2ZR	6210 ZZ	6308 N	6308 N	K2789.2720	2789 / 2720	K498.493	498 / 493
6210	6210	6308 NR	6308 NR	K29675.29630	29675 / 29630	K498A.492A	498 A / 492 A
6210ZR	6210 Z	6308 ZRN.C3	6308 ZNR / C3	K29685.29620	29685 / 29620	K52400.52618	52400 / 52618
6211 N/C3	6211 N / C3	6308 ZRNR	6308 ZNR	K31594.31520	31594 / 31520	K537.532X	537 / 532 X
6211.2RSR	6211 2RS	6308.2RSR	6308 2RS	K31597.31520	31597 / 31520	K55200.55437	55200 C / 55437
6211/C3	6211 C3	6308	6308	K3196.3120	3196 / 3120	K55200C.55437	55200 C / 55437
6211	6211	6308NR.C4	6308 NR / C4	K33275.33472	33275 / 33472	K55206C.55437	55206 C / 55437
6211ZR	6211 Z	6309 NR	6309 NR	K33281.33462	33281 / 33462	K555S.552A	555 S / 552 A
6211ZRNR	6211 ZNR	6309.2RSR	6309 2RS	K33287.33462	33287 / 33462	K559.552A	559 / 552 A
6212.2RSR	6212 2RS	6309	6309	K3382.3320	3382 / 3320	K56425.56650	56425 / 56650
6212	6212	6309ZRNR.C3	6309 ZNR / C3	K33885.33822	33885 / 33822	K567.563	567 / 563
6212NR	6212 NR	6310.2RSR	6310 2RS	K33889.33822	33889 / 33822	K580.572	580 / 572
62201.2RSR.C3	62201 2RS / C3	6310/C3	6310 C3	K33889.33882	33889 / 33882	K581.572	581 / 572
62202.2RSR.C3	62202 2RS / C3	6310	6310	K33895.33821	33895 / 33821	K59175.59412	59162 / 59412
62204.2RSR	62204 2RS	6311.C3	6311 C3	K33895.33822	33895 / 33822	K59175.59412	59175 / 59412
62302.2RSR.C3	62302 2RS / C3	6312.C3	6312 C3	K34274.34492A	34274 / 34492 A	K594.592A	594 / 592 A
63006.2RSR.C4	63006 2RS / C4	6312/C3	6312 C3	K34306.34478	34306 / 34478	K594.592A	594 / 592A
6302.2RSR.C3	6302 2RS / C3	6314N.C3	6314 C3	K3585.3525	3585 / 3525	K594A.592A	594 A / 592 A
6302	6302	6314N.C3	6314 N / C3	K3586.3525	3586 / 3525	K594A.592A	594 A / 592 A
6302ZR	6302 Z	6403.2RSR.C3	6403 2RS / C3	K368S.362	368 S / 362	K598A.592A	598 A / 592 A
6303 RSR.C3	6303 RS / C3	6403.C3	6403 2RS / C3	K3767.372	3767 / 372	K598A.592A	598 A / 592 A
6303 ZR.C3	6303 ZZ / C3	6403.C3	6403 C3	K3780.3720	3780 / 3720	K598A.593X	598 A / 593 X
6303.2RSR	6303 2RS	6408	6408	K3782.3720	3782 / 3720	K6386.6320	6386 / 6320
6303.2RSR.C3	6203 2RS / C3	800179D	F 16065	K387.382A	387 / 382 A	K641.632	641 / 632
6303.2RSR.C3	6303 2RS / C3	801136	F 16040	K387A.382A	387 A / 382 A	K64450.64700	64450 / 64700
6303.2RSR.C3	6303 2RS/C3	803775	F 16083	K387A.382S	387 A / 382 S	K6461A.6420	6461A / 6420
6303.2RSR.C3	6303 RS / C3	803837A.E30	F 15043	K387AS.382A	387 AS / 382 A	K65237.65500	65237 / 65500
6303.2ZR	6303 ZZ	804339	F 19042	K388A.382	388 A / 382	K66225.66462	66225 / 66462
6303.2ZR.C3	6303 Z / C3	804358	F 15156	K39250.39412	39250 / 39412	K663.653	663 / 653
6303.2ZR.C3	6303 ZZ / C3	805262	F 19001	K39520.39590	39590 / 39520	K681A.672	681 A / 672
6303-2RSH/ C3HT	6303 2RS / C3	805274 (K368A.362A)	368 A / 362 A	K39580.39520	39580 / 39520	K683.672	683 / 672
6303	6303	805449	F 19010	K39581.39520	39581 / 39520	K68450.68712	68450 / 68712
6303RSR.C3	6303 RS/C3	805450	F 19039	K39581.45220	39581 / 45220	K68462.68712	68462 / 68712
6303ZR	6303 Z	AK25877.25821	25877 / 25821	K39590.39520	39590 / 39520	K687.672	687 / 672
				K3982.3920	3982 / 3920	K72188C.72487	72188 C / 72487
						K72200C.72487	72200 C / 72487
						K72212C.72487	72212 C / 72487

K72218C.72487	72218 C / 72487
K749.742	749 / 742
K760.752	760 / 752
K78215C.78551	78215 C / 78551
K78225C.78551	78225 C / 78551
K78225C.78551. J42B	78225 C / 78551
K9278.9220	9278 / 9220
KH715334.11	H 715334 / H 715311
KH715343.11	H 715343 / H 715311
KH715345.11	H 715345 / H 715311
KH715345. H715311	H 715345 / H 715311
KH913842.913810	H 913842 / H 913810
KH913842. H913810	H 913842 / H 913810
KH913843.913810	H 913842 / H 913810
KH914841.11	H 914841 / H 914811
KHM212044.11	HM 212044 / HM 212011
KHM212047.11	HM 212047 / HM 212011
KHM212047. HM212011	HM 212047 / HM 212011
KHM212047. HM212011	HM 212049 / HM 212011
KHM212049.11	HM 212049 / HM 212011
KHM212049. HM212011	HM 212047 / HM 212011
KHM212049. HM212011	HM 212049 / HM 212011
KHM212049. HM212011	HM 212049 / HM 212011
KHM218248.10	HM 218248 / HM 218210
KHM218248. HM218210	HM 218248 / HM 218210
KHM220149. HM220110	HM 220149 / HM 220110
KHM516449.10	HM 516449 / HM 516410
KHM518445.10	HM 518445 / HM 518410
KHM803145. HM803110	HM 803145 / HM 803110
KHM803146. HM803110	HM 803146 / HM 803110
KHM803149.10	HM 803149 / HM 803110
KHM804843. HM804810	HM 804843 / HM 804810
KHM804846.10	HM 804846 / HM 804810
KHM804846. HM804810	HM 804846 / HM 804810
KHM807040.10	HM 807040 / HM 807010
KHM807040. HM807010	HM 807040 / HM 807010
KHM807046.10	HM 807046 / HM 807010
KHM807046.11	HM 807046 / HM 807011
KHM807046. HM807010	HM 807046 / HM 807010

KHM807049.10	HM 807049 / HM 807010
KHM813841.10	HM 813841 / HM 813810
KHM813842. HM813810	HM 813842 / HM 813810
KHM813843.10	HM 813843 / HM 813810
KHM88542.10	HM 88542 / HM 88510
KHM89443.11	HM 89443 / HM 89411
KHM903249.10	HM 903249 / HM 903210
KHM911245. HM911210	HM 911245 / HM 911210
KJH211749.10	JH 211749 / JH 211710
KJHM522649. JHM522610	JHM 522649 / JHM 522610
KJHM720249.10	JHM 720249 / JHM 720210
KJLM104946.11A	JLM 104946 / JLM 104911 A
KJLM710949.10	JLM 710949 / JLM 710910
KJLM710949C.10	JLM 710949 C / JLM 710910
KJLM714149.10	JLM 714149 / JLM 714110
KJM207049.10	JM 207049 / JM 207010
KJM207049A.10	JM 207049 A / JM 207010
KJM207049A.11	JM 207049 A / JM 207011
KJM511946.10	JM 511946 / JM 511910
KJM714249. JM714210	JM 714249 / JM 714210
KJM716649.10	JM 716649 / JM 716610
KJM720249.10	JM 720249 / JM 720210
KL44649.L44610	L 44649 / L 44610
KLM102949.10	LM 102949 / LM 102910
KLM104949.10	LM 104949 / LM 104910
KLM104949.11	LM 104949 / LM 104911
KLM104949.12	LM 104949 / LM 104912
KLM11749. LM11710	LM 11749 / LM 11710
KLM11949. LM11910	LM 11949 / LM 11910
KLM11949. LM11910	LM 11949 / LM 11910
KLM29749. LM29710	LM 29749 / LM 29710
KLM29749. LM29711	LM 29749 / LM 29711
KLM300849. LM300811	LM 300849 / LM 300811
KLM48548. LM48510	LM 48548 / LM 48510
KLM48548. LM48510	LM 48548 / LM 48510

KLM501349. LM501310	LM 501349 / LM 501310
KLM501349. LM501314	LM 501349 / LM 501314
KLM503349A. LM503310	LM 503349 A / LM 503310
KLM603049. LM603011	LM 603049 / LM 603011
KLM67048. LM67010	LM 67048 / LM 67010
KLM78349. LM78310TVP	LM 78349 / LM 78310
KLM806649. LM806610	LM 806649 / LM 806610
KM12649. M12610	M 12649 / M 12610
KM802048. M802011	M 802048 / M 802011
KM804049.10	M 804049 / M 804010
KM88043. M88010	M 88043 / M 88010
KM88048.10	M 88048 / M 88010
MU 1308UM	F 19034
N207E.TN.C3	N 207 / C3
N2211ENR.MI.C3	N 2211 FMNR / C3
N309E.M1	N 309 FM
NJ205E.TVP2.C3	NJ 205 / C3
NJ206E.TVP2	NJ 206
NJ2206E.TVP2	NJ 2206 FM
NJ2211E.M1	NJ 2211 FM
NJ2309E.TVP2.C3	NJ 2309 FM / C3
NJ304EN.TVP2	NJ 304 FM
NJ304EN.TVP2	NJ 304 FMN
NJ305E.TVP2.C3	NJ 305 FM / C3
NJ309E.TVP2	NJ 309 FM
NJ309E.TVP2.C3	NJ 309 FM / C3
NJ309E.TVP2.C3	NJ 309 FP / C3
NU206E.TVP2	NU 206 FM
NU208EN.TN	NU 208 FM
NU209EN.TVP2	NU 209 FMN
NU303E.TVP2	NU 303 FM
NU310E.TVP2.C3	NU 310 FM / C3
NUP206	NUP 206 FM
NUP2205E.TVP2	NUP 2205
NUP2212E.804339	NUP 2212 FMN
NUP2212E.TVP2	NUP 2212 F
NUP309E.TVP	NUP 309 FM
NUP309E.TVP.C3	NUP 309 FM / C3
NUP310EJ.P3.C3	NUP 310 FMN / C3
NUP311EN.M1.C3	NUP 311 FM / C3
NUP314EN.M1.C3	NUP 314 FM / C3
NUP314EN.M1.C3	NUP 314 FMNR / C3
QJ208.TVP. A50.80	QJ 208 FM
QJ209TNH. A50.80	QJ 209 FM
QJ212TVP.E30. T42A	QJ 212 FM
QJ309TNH. A50.80	QJ 309 FM
SA0006	F 16078
SA0009	F 16081

SA0028	F 16199
SA0030	F 16052
SA0032	F 16198
SA0057	F 16197
SA0060	F 16196
SAM0009	F 15175
SAM0012	F 15128
T2DD065	JD 6549 / JD 6510
T2ED050	JF 5049 / JF 5010
T2EE040	JF 4049 / JF 4010
T2EE100	JF 10049 / JF 10010
WBK0001	KA 075
WBK0002	KA 069
WBK0003	KA 038
WBK0004	KA 040
WBK0005	KA 021
WBK0006	KA 019
WBK0007	KA 273
WBK0008	KV 164

Fersa	SKF
11590 / 11520	11590/11520/Q
14131 / 14276	14131/14276/Q
25577 / 25523	25577/2/25523/2/Q
25581 / 25520	25581/25520
25590 / 25522	25590/Q + 25522/Q
25590 / 25522	25590/Q + 25522/Q
25877 / 25821	25877/2/25821/2/Q
368 A / 362 A	368 A/362 A/Q
368 A / 362 X	368 A/362 X/Q
387 / 382 A	387 A/382 A/Q
387 A / 382 A	387 A/382 A/Q
387 A / 382 A	387 A/382 A/Q
3782 / 3720	3782/3720
30203 F	30203 J2/Q
30203 F	30203 J2
30204 F	30204 J2/Q
30205 F	30205 J2/Q
30205 F	32205 BJ2/Q
30206 F	30206 J2/Q
30207 F	30207 J2/Q
30213 F	30213 J2/Q
30214 F	30214 J2/Q
30216 F	30216 J2/Q
30217 F	30217 J2/Q
30217 F	33017/Q
30220 F	30220 J2
30222 F	30222 J2
30302 F	30302 J2
30306 F	30306 J2/Q
30307 F	30307 J2/Q
30307 F	30307 J2/Q
30308 F	30308 J2/Q
30309 F	30309 J2/Q

CROSS REFERENCES
 CRUZAMENTO DE REFERÊNCIAS
 CRUCE DE REFERENCIAS

Fersa - SKF

30312 F	30312 J2/Q	33022 F	33022	6202	6202	6211 N / C3	6211 N/C3
30313 F	30313 J2/Q	33109 F	33109/Q	6202 2RS	6202-2RS1	6211 ZNR	6211-ZNR
30314 F	30314 J2/Q	33111 F	33111/QVB500	6202 2RS	6202-2RSH/C3GJN	6212	6212
310 NR	310 NR	33113 F	33113 R/Q	6202 2RS / C3	6202-2RSH/C3GJN	6212 ZNR	6212-ZNR
31306 F	31306 J2/Q	33114 F	33114/Q	6202 Z / C3	6202-2RSH/C3GJN	6213 C3	6213 N/C3
31308 F	31308 J2/QCL7C	33115 F	33115/Q	6202 ZZ	6202-2Z	6214	6214
31309 F	31309 J2/QCL7C	33117 F	33117/Q	6203	6203	6215 C3	6215/C3
31311 F	31311 J2/Q	33208 F	33208/Q	6203 2RS	6203-2Z	6215 NR / C3	6215 NR/C3
31312 F	31312 J2/Q	33209 F	33209/Q	6203 2RS	6203-2RSH/ C3GJN	6216 C3	6216/C3
31312 F	31312 J2/QCL7C	33210 F	33210/Q	6203 2RS	6203-2RSH	6218 C3	6218/C3
31312 F	31312 J2/Q	33212 F	33212/Q	6203 2RS	6203-2RSH	6302	6302
31313 F	31313 J2/QCL7C	33213 F	33213/Q	6203 2RS / C3	6203-2RSH/C3GJN	6302 2RS	6302-2RSH
31314 F	31314 J2/QCL7A	33214 F	33214/Q	6203 2RS / C3	6203-2RS1/C3	6302 2RS / C3	6302-2RS1/C3
31315 F	31315 J2/ QCLN7C	33215 F	33215/Q	6203 2RS / C3	6303-2RSH/C3GJN	6303	6303
31594 / 31520	31594/2/31520/2	39590 / 39520	39590/39520/Q	6203 2RS / C3	6203-2RSH/ C3HT22VT200	6303 2RS	6303-2RSH
32007 XF	32007 X/Q	482 / 472	482/472/Q	6203 2RS / C3	6203.2RSR.C3	6303 2RS / C3	6303-2RSH/ C3GJN
32008 XF	32008 X/Q	497 / 492 A	497/492 A	6203 2RS / C3	6203-2Z/C3	6303 2RS / C3	6303-2RSH/ C3HT
32009 XF	32009 X/Q	497 / 493	497/493	6203 C3	6203/C3	6303 2RS / C3	6303-2RSH/ C3HT22
32010 XF	32010 X/Q	42381 / 42584	42381/42584	6203 C3	6206/C3	6303 2RS / C3	6303.2RSR.C3
32015 XF	32015 X/Q	47487 / 47420 A	47487/47420 A/Q	6203 ZZ	6203-2Z	6303 RS / C3	6303-RS1/C3
32017 XF	32017 X/Q	580 / 572	580/572/Q	6203 ZZ	6203-2RSH/ C3HT22VT200	6303 ZZ / C3	6303-Z/C3
32018 XF	32018 X/Q	594 / 592	594/592 A/Q	6204	6204	6304	6304
32019 XF	32019 X/Q	594 / 592 A	594/592 A/Q	6204 / C3	6204 ETN9/C3H	6304 2RS	6304-2RS1
32020 XF	32020 X/Q	594 A / 592 A	594 A/592 A/Q	6204 2RS	6204-2RS1	6304 C3	6304/C3
32022 XF	32022 X/Q	56425 / 56650	56425/56650	6204 2RS / C3	6204-2RS1/C3	6304 C3	6304/C4
32205 BF	32205 BJ2/Q	687 / 672	687/672	6205	6205	6304 ZZ	6304-Z
32205 F	32205 BJ2/Q	6001	6001	6205 2RS	6205-2RS1	6305	6305
32206 F	32206 J2/Q	6001 / C3	6001/C3	6205 2RS	6205-RS1	6305 / C3	6305/C3
32206 F	32206 J2/Q	6001 2RS / C3	6001-2RS1/C3LHT23	6205 2RS / C3	6205-2RS1	6305 / C3	6305 ETN9/C3
32207 F	32207 J2/Q	6003 2RS / C3	6003-2RS1/C3GJN	6205 2RS / C3	6205	6305 2RS	6305-2RS1
32207 F	32207 J2/Q	6004	6004	6205 C3	6305/C3	6305 2RS	6305-2RS1/ HT22B
32208 F	30308 J2/Q	6005 2RS / C3	6005-2RS1/C3HHT22	6205 RS	6205-RS1	6305 2RS	6305
32208 F	32208 J2/Q	6006 2RS	6006/32-2RS1/ VB005	6205 Z	6205-Z	6305 2RS / C3	6305-2RS1/ C3GJN
32212 F	32212 J2/QVB022	6006 2RS	6006-2RS1	6205 ZZ	6205-2Z	6305 C3	6305/C3
32213 F	32213 J2/Q	6006 2RS / C3	6006-2RS1/C3GJN	6206	6206	6306 / C3	6306/C3
32214 F	32214 J2/Q	6006 RS / C3	6006-RS1/C3GJN	6206 / C3	6206/C3	6306 2RS	6306-2RS1
32216 F	32216 A	6007	6007	6206 2RS	6206-2RS1	6306 NR	6306 NR
32218 F	32218 A	6007 N	6007 N	6206 2RS / C3	6206-2RSH/ C3GJN	6306 NR 2RS / C3	6306-2RS1NR/C3
32219 F	32219 J2/Q	6009	6009	6206 2RS / C3	6206.2RSR.C3	6306 ZNR	6306-ZNR
32304 F	32304 J2/Q	6009 C3	6009/C3	6206 C3	6206/C3	6306 ZNR / C3	6306 ZNR/C3
32305 F	32305 J2	6010	6010	6206 NR	6206 NR	6306 ZZ	6306-2Z
32306 F	32306 J2/Q	6011	6011	6206 ZZ	6206-2Z	6307 NR	6307 NR
32307 F	32307 J2/Q	6011 / C3	6011/C3	6206 ZZ / C3	6206-2Z/C3	6307 NR 2RS	6307-2RS1NR
32308 F	32308 J2/Q	6014	6014	6207	6207/C3	6307 Z	6307-Z
32309 F	32309 J2/Q	6014 2RS	6014-2RS1	6207 C3	6207/C3	6307 ZNR	6307-ZNR
32310 F	32310 J2/Q	6014 C3	6014/C3	6207 NR	6207 NR	6308	6308
32312 F	32312 J2/Q	6015 Z	6015-Z	6207 ZN / C3	6207-ZN/C3	6308 N	6308 N
32313 BF	32313 BJ2/ QU4CL7CVQ267	6017 NR	6017 NR	6207 ZNR	6207-ZNR	6308 NR	6308 NR
32313 F	32313 J2/Q	6200 2RS	6200-2RS1	6208	6208	6308 ZNR	6308-ZNR
32314 BF	32314 BJ2/QCL7C	6201	6201	6208 2RS	6208-2RS1	6309 NR	6309 NR
32315 BF	32315 BJ2/QCL7C	6201 2RS / C3	6201-2RS1/C3GJN	6208 N	6208 N	6309 NR / C3	6309 NR/C3
32315 F	32315 J2	6201 2RS / C3	6201-2RSH/C3GJN	6209	6209	6309 Z / C3	6309-Z/C3
33011 F	33011/Q	6201 2RS / C3	6201.2RSR.C3	6209 C3	6209/C3	6309 ZNR / C3	6309 NR/C3
33017 F	33017/Q	6201 Z / C3	6201-Z/C3	6210	6210	6310	6310
33019 F	33019/Q	6201 Z / C3	6201-2RSH/C3GJN	6211	6211	6310 2RS	6310-2RS1
33020 F	33020/Q	6201 Z / C3	62201-2RS1/C3VT193	6211 C3	6211/C3		
33021 F	33021/Q	6201 ZZ	6201-2Z				
		6201 ZZ / C3	6201-Z/C3				

6310 C3	6310/C3	JL 69349 / JL 69310	JL 69349/310/Q	25590/Q + 25522/Q	25590 / 25522	32205 BJ2/Q	32205 F
6311	6311	JLM 508748 / JLM 508710	JLM 508748/710/Q	25877/2/25821/2/Q	25877 / 25821	32206 J2/Q	32206 F
6311 C3	6311 N/C3	JM 716649 / JM 716610	JM 716649/JM 716610	239697/Q	F 15046	32206 J2/Q	32206 F
6311 NR / C3	6311 NR/C3	JP 12049 / JP 12010	JP 12049/JP 12010	368 A/362 A/Q	368 A / 362 A	32207 J2/Q	32207 F
6312 C3	6312/C3	KF 145	VKBA 3554	368 A/362 X/Q	368 A / 362 X	30308 J2/Q	32208 F
6313 C3	6313/C3	L 45449 / L 45410	L 45449 F/410/Q	387 A/382 A/Q	387 / 382 A	32208 J2/Q	32208 F
6314	6314	LM 11749 / LM 11710	LM 29749 F/711/Q	387 A/382 A/Q	387 A / 382 A	32212 J2/ QVB022	32212 F
6314 C3	6314 N/C3	LM 29749 / LM 29710	LM 29749/710/Q	387 A/382 A/Q	387 A / 382 A	32213 J2/Q	32213 F
6314 NR / C3	6314 N/C3	LM 300849 / LM 300811	LM 300849/811/Q	3782/3720	3782 / 3720	32214 J2/Q	32214 F
6403 2RS / C3	6403-2RS1/C3	LM 48548 / LM 48510	LM 48548/510/Q	30203 J2/Q	30203 F	32216 A	32216 F
6407 C3	6407/C3	LM 501349 / LM 501310	LM 501349/310/Q	30203 J2	30203 F	32218 A	32218 F
6408	6408	LM 501349 / LM 501314	LM 501349/314/Q	30204 J2/Q	30204 F	32219 J2/Q	32219 F
6409	6409	LM 603049 / LM 603012	LM 603049/012	30205 J2/Q	30205 F	32304 J2/Q	32304 F
6409 C3	6409/C3	LM 806649 / LM 806610	LM 806649/610/Q	32205 BJ2/Q	30205 F	32305 J2	32305 F
6409 NR / C3	6409 NR/C3	M 12649 / M 12610	M 12649/610/Q	30206 J2/Q	30206 F	32306 J2/Q	32306 F
6411 NR / C3	6411 NR/C3	M 802048 / M 802011	M 802048/011/ QCL7C	30207 J2/Q	30207 F	32307 J2/Q	32307 F
62201 2RS / C3	62201-2RS1/ C3VT193	M 802048 / M 802011	M 802048/011/ QCL7C	30213 J2/Q	30213 F	32308 J2/Q	32308 F
62201 2RS / C3	62201-2RS1/ C3HTVT193	M 84548 / M 84510	M 84548/2/510/2/ QVQ506	30214 J2/Q	30214 F	32309 J2/Q	32309 F
62202 2RS / C3	62202-2RS1/C3	M 86647 / M 86610	M 86647/610/ QCL7C	30216 J2/Q	30216 F	32310 J2/Q	32310 F
62204 2RS	62204-2RS1	M 86649 / M 86610	M 86649/2/610/2/ QVQ506	30217 J2/Q	30217 F	32312 J2/Q	32312 F
62205 2RS	62205-2RS1	M 88048 / M 88010	M 88048/2/010/2/ QCL7C	33017/Q	30217 F	32312 J2/Q	32312 F
62206 2RS	62206-2RS1	NJ 305 C3	NJ 305 ECP/C3	30220 J2	30220 F	32313 BJ2/ QU4CL7CVQ267	32313 BF
62302 2RS / C3	62302-2RS1/C3	NJ 305 FM / C3	NJ 305 ECP/C3	30222 J2	30222 F	32313 J2/Q	32313 F
63006 2RS / C4	63006-2RS1/C4	NJ 307 FM	NJ 307 ECJ	30306 J2/Q	30306 F	32314 BJ2/ QCL7C	32314 BF
63008 2RS	63008-2RS1/HT	NU 2205	NU 2205 ECP	30307 J2/Q	30307 F	32315 BJ2/ QCL7C	32315 BF
F 15046	239697/Q	NU 303 FM	NU 303 ECP	30308 J2/Q	30308 F	32315 J2	32315 F
F 15047	331305 A/Q	NUP 212 FM	NUP 212 ECP	30309 J2/Q	30309 F	33011/Q	33011 F
F 15067	BTH 1206 AB	NUP 308 ECP	NUP 308 ECP	30312 J2/Q	30312 F	33017/Q	33017 F
F 15071	BT1B 243150/ QCL7C	NUP 311 FM	NUP 311 ECP	30313 J2/Q	30313 F	33019/Q	33019 F
F 15076	331126/Q	NUP 311 FM / C3	NUP 311 ECNM/C3	30314 J2/Q	30314 F	33020/Q	33020 F
F 15083	331075/Q	NUP 311 FMNR / C3	NUP 311 ECNM/ C3VM014	310 NR	310 NR	33021/Q	33021 F
F 15116	BT1B 329012/Q	NUP 311 FMNR / C3	NUP 311 ECNM/C3	31306 J2/Q	31306 F	33022	33022 F
F 16029	BAH 0051 B	NUP 314 FM	NUP 314 ECP	31308 J2/ QCL7C	31308 F	33109/Q	33109 F
F 16030	BAH 0094	NUP 314 FMNR	NUP 314 ECNRP	31309 J2/ QCL7C	31309 F	33111/QVB500	33111 F
F 16035	BAHB 311315 BD	NUP 314 FMNR / C3	NUP 314 ECNRP	31311 J2/Q	31311 F	33113 R/Q	33113 F
F 16048	BAH 0171	NUP 314 FMNR / C3	NUP 314 ECNRP	31312 J2/Q	31312 F	33114/Q	33114 F
F 16051	BAH 0177	NUP 314 FMNR / C3	NUP 314 ECNRP	31312 J2/ QCL7C	31312 F	33115/Q	33115 F
F 19011	315070 B	NUP 314 FMNR / C3	NUP 314 ECNRP	31312 J2/Q	31312 F	33117/Q	33117 F
F 19046	BC1B 322467/HB3	NUP 314 FMNR / C3	NUP 314 ECNRP	31313 J2/ QCL7C	31313 F	33208/Q	33208 F
F 19047	BC1B 322172 A	NUP 314 FMNR / C3	NUP 314 ECNRP	31314 J2/ QCL7A	31314 F	33209/Q	33209 F
F 300006	BTFB 328755D	NUP 314 FMNR / C3	NUP 314 ECNRP	31315 J2/ QCLN7C	31315 F	33210/Q	33210 F
H 913842 / 10	H 913842/810/ QCL7C	25590/Q + 25522/Q	25590 / 25522	31594/2/31520/2	31594 / 31520	33212/Q	33212 F
HM 88542 / HM 88510	HM 88542/2/510/2/ QCL7C	25577/2/25523/2/Q	25577 / 25523	32007 X/Q	32007 XF	33213/Q	33213 F
HM 88649 / HM 88610	HM 88649/2/610/2/ QCL7C	25581/25520	25581 / 25520	32008 X/Q	32008 XF	33214/Q	33214 F
HM 88649 / HM 88620	HM 88649/2/620/2/ QCL7C	25590/Q + 25522/Q	25590 / 25522	32009 X/Q	32009 XF	33215/Q	33215 F
HM 89449 / HM 89410	HM 89449/2/410/2/ QCL7C	SKF	Fersa®	32010 X/Q	32010 XF	39590/39520/Q	39590 / 39520
HM 803146 / HM 803110	HM 803146/2/110/2/ QCL7C	11590/11520/Q	11590 / 11520	32011 X/Q	32011 XF	315070 B	F 19011
HM 807040 / HM 807010	HM 807040/010/ QCL7C	14131/14276/Q	14131 / 14276	32012 X/Q	32012 XF	331075/Q	F 15083
HM 807046 / HM 807010	HM 807046/010/ QCL7C	25577/2/25523/2/Q	25577 / 25523	32013 X/Q	32013 XF	331126/Q	F 15076
HM 807046 / HM 807010	HM 807046/010/ QCL7C	25581/25520	25581 / 25520	32014 X/Q	32014 XF	331305 A/Q	F 15047
HM 807046 / HM 807010	HM 807046/010/ QCL7C	25590/Q + 25522/Q	25590 / 25522	32015 X/Q	32015 XF	482/472/Q	482 / 472
HM 807046 / HM 807010	HM 807046/010/ QCL7C	SKF	Fersa®	32017 X/Q	32017 XF	497/492 A	497 / 492 A
		11590/11520/Q	11590 / 11520	32018 X/Q	32018 XF	497/493	497 / 493
		14131/14276/Q	14131 / 14276	32019 X/Q	32019 XF	42381/42584	42381 / 42584
		25577/2/25523/2/Q	25577 / 25523	32020 X/Q	32020 XF	47487/47420 A/Q	47487 / 47420 A
		25581/25520	25581 / 25520	32022 X/Q	32022 XF	580/572/Q	580 / 572
		25590/Q + 25522/Q	25590 / 25522	32205 BJ2/Q	32205 BF	594/592 A/Q	594 / 592

CROSS REFERENCES
 CRUZAMENTO DE REFERÊNCIAS
 CRUCE DE REFERENCIAS

SKF - Fersa®





594/592 A/Q	594 / 592 A	6203-2RSH/ C3HT22VT200	6203 2RS / C3	6303-2RSH/ C3GJN	6303 2RS / C3	62201-2RS1/ C3VT193	62201 2RS / C3
594 A/592 A/Q	594 A / 592 A	6203.2RSR.C3	6203 2RS / C3	6303-2RSH/ C3HT	6303 2RS / C3	62201-2RS1/ C3HTVT193	62201 2RS / C3
56425/56650	56425 / 56650	6203-2Z/C3	6203 2RS / C3	6303-2RSH/ C3HT22	6303 2RS / C3	62202-2RS1/C3	62202 2RS / C3
687/672	687 / 672	6203/C3	6203 C3	6303.2RSR.C3	6303 2RS / C3	62204-2RS1	62204 2RS
6001	6001	6206/C3	6203 C3	6303-2RSH/ C3HT22	6303 2RS / C3	62205-2RS1	62205 2RS
6001/C3	6001 / C3	6203-2Z	6203 ZZ	6303-RS1/C3	6303 RS / C3	62206-2RS1	62206 2RS
6001-2RS1/ C3LHT23	6001 2RS / C3	6203-2RSH/ C3HT22VT200	6203 ZZ	6303-Z/C3	6303 ZZ / C3	62302-2RS1/C3	62302 2RS / C3
6003-2RS1/ C3GJN	6003 2RS / C3	6204	6204	6304	6304	63006-2RS1/C4	63006 2RS / C3
6004	6004	6204 ETN9/C3H	6204 / C3	6304-2RS1	6304 2RS	63008-2RS1/HT	63008 2RS
6005-2RS1/ C3HHT22	6005 2RS / C3	6204-2RS1	6204 2RS	6304/C3	6304 C3	BAH 0051 B	F 16029
6006/32-2RS1/ VB005	6006 2RS	6204-2RS1/C3	6204 2RS / C3	6304/C4	6304 C3	BAH 0094	F 16030
6006-2RS1	6006 2RS	6205	6205	6304-Z	6304 ZZ	BAH 0171	F 16048
6006-2RS1/ C3GJN	6006 2RS / C3	6205-2RS1	6205 2RS	6305	6305	BAH 0177	F 16051
6006-RS1/ C3GJN	6006 RS / C3	6205-RS1	6205 2RS	6305/C3	6305 / C3	BAH 311315 BD	F 16035
6007	6007	6205-2RS1	6205 2RS / C3	6305 ETN9/C3	6305 / C3	BC1B 322172 A	F 19047
6007 N	6007 N	6205	6205 2RS / C3	6305-2RS1	6305 2RS	BC1B 322467/ HB3	F 19046
6009	6009	6305/C3	6205 C3	6305-2RS1/ HT22B	6305 2RS	BT1B 243150/ QCL7C	F 15071
6009/C3	6009 C3	6205-RS1	6205 RS	6305	6305 2RS	BT1B 329012/Q	F 15116
6010	6010	6205-Z	6205 Z	6305-2RS1/ C3GJN	6305 2RS / C3	BTFB 328755D	F 300006
6011	6011	6205-2Z	6205 ZZ	6305/C3	6305 C3	BTH 1206 AB	F 15067
6011/C3	6011 / C3	6206	6206	6306/C3	6306 / C3	H 913842/810/ QCL7C	H 913842 / H 913810
6014	6014	6206/C3	6206 / C3	6306-2RS1	6306 2RS	HM 88542/2/510/2/ QCL7C	HM 88542 / HM 88510
6014-2RS1	6014 2RS	6206-2RS1	6206 2RS	6306 NR	6306 NR	HM 88649/2/610/2/ QCL7C	HM 88649 / HM 88610
6014/C3	6014 C3	6206-2RSH/ C3GJN	6206 2RS / C3	6306-2RS1NR/C3	6306 NR 2RS / C3	HM 88649/2/620/2/ QCL7C	HM 88649 / HM 88620
6015-Z	6015 Z	6206 NR	6206 NR	6306-ZNR	6306 ZNR / C3	HM 89449/2/410/2/ QCL7C	HM 89449 / HM 89410
6017 NR	6017 NR	6206-2Z	6206 ZZ	6306-2Z	6306 ZZ	HM 803146/2/110/2/ QCL7C	HM 803146 / HM 803110
6200-2RS1	6200 2RS	6206-2Z/C3	6206 ZZ / C3	6307 NR	6307 NR	HM 807040/010/ QCL7C	HM 807040 / HM 807010
6201	6201	6207/C3	6207	6307-2RS1NR	6307 NR 2RS	HM 807046/010/ QCL7C	HM 807046 / HM 807010
6200-2RS1/ C3GJN	6200 2RS / C3	6207/C3	6207 C3	6307-Z	6307 Z	JL 69349/310/Q	JL 69349 / JL 69310
6201-2RSH/ C3GJN	6201 2RS / C3	6207 NR	6207 NR	6307-ZNR	6307 ZNR	JLM 508748/710/Q	JLM 508748 / JLM 508710
6201.2RSR.C3	6201 2RS / C3	6207-ZN/C3	6207 ZN / C3	6308	6308	JM 716649/ JM 716610	JM 716649 / JM 716610
6201-Z/C3	6201 Z / C3	6207-ZNR	6207 ZNR	6308 N	6308 N	JP 12049/ JP 12010	JP 12049 / JP 12010
6201-2RSH/ C3GJN	6201 Z / C3	6208	6208	6308 NR	6308 NR	L 45449 F/410/Q	L 45449 / L 45410
62201-2RS1/ C3VT193	6201 Z / C3	6208-2RS1	6208 2RS	6308-ZNR	6308 ZNR	LM 29749 F/711/Q	LM 11749 / LM 11710
6201-2Z	6201 ZZ	6208 N	6208 N	6309 NR	6309 NR	LM 29749/710/Q	LM 29749 / LM 29710
6201-Z/C3	6201 ZZ / C3	6209	6209	6309 NR/C3	6309 NR / C3	LM 300849/811/Q	LM 300849 / LM 300811
6202	6202	6209/C3	6209 C3	6309-Z/C3	6309 Z / C3	LM 48548/510/Q	LM 48548 / LM 48510
6202-2RS1	6202 2RS	6209 NR/C3	6209 NR / C3	6309 NR/C3	6309 ZNR / C3	LM 501349/310/Q	LM 501349 / LM 501310
6202-2RSH/ C3GJN	6202 2RS	6210	6210	6310	6310	LM 501349/314/Q	LM 501349 / LM 501314
6202-2RSH/ C3GJN	6202 2RS / C3	6211	6211	6310-2RS1	6310 2RS	LM 603049/012	LM 603049 / LM 603012
6202-2RSH/ C3GJN	6202 Z / C3	6211/C3	6211 C3	6311	6311	LM 806649/610/Q	LM 806649 / LM 806610
6202-2Z	6202 ZZ	6211 N/C3	6211 N / C3	6311 N/C3	6311 C3	M 12649/610/Q	M 12649 / M 12610
6203	6203	6211-ZNR	6211 ZNR	6311 NR/C3	6311 NR / C3	M 84548/2/510/2/ QVQ506	M 84548 / M 84510
6203-2Z	6203 2RS	6212	6212	6312/C3	6312 C3		
6203-2RSH/ C3GJN	6203 2RS	6212-ZNR	6212 ZNR	6313/C3	6313 C3		
6203-2RSH	6203 2RS	6213 N/C3	6213 C3	6314	6314		
6203-2RSH/ C3GJN	6203 2RS / C3	6214	6214	6314 N/C3	6314 C3		
6203-2RS1/C3	6203 2RS / C3	6215/C3	6215 C3	6314 N/C3	6314 NR / C3		
6303-2RSH/ C3GJN	6203 2RS / C3	6215 NR/C3	6215 NR / C3	6403-2RS1/C3	6403 2RS / C3		
		6216/C3	6216 C3	6407/C3	6407 C3		
		6218/C3	6218 C3	6408	6408		
		6302	6302	6409	6409		
		6302-2RSH	6302 2RS	6409/C3	6409 C3		
		6302-2RS1/C3	6302 2RS / C3	6409 NR/C3	6409 NR / C3		
		6303	6303	6411 NR/C3	6411 NR / C3		
		6303-2RSH	6303 2RS				

Drawings

Desenhos

Planos

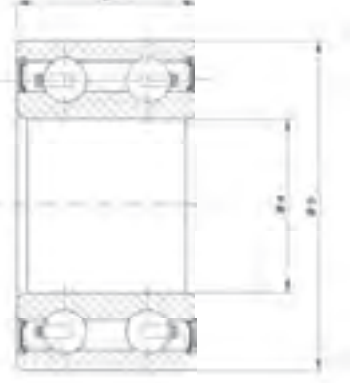
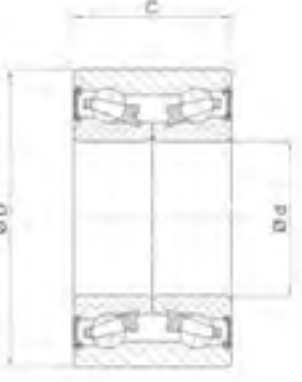
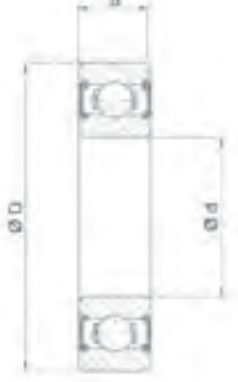
10.11

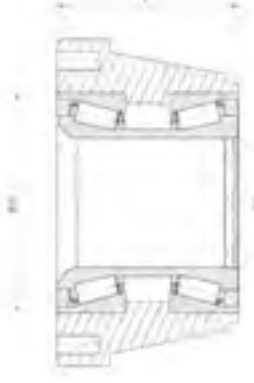
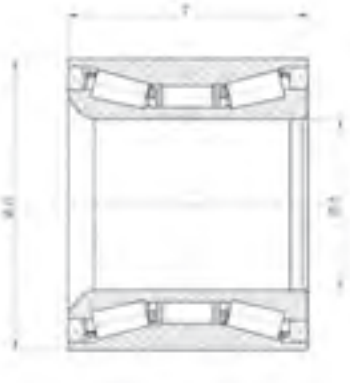
<p>BB 4PAC</p> 	<p>BB</p> 	<p>BB 2R</p> 
<p>BBDRAC</p> 	<p>BBS</p> 	<p>CRB</p> 
<p>CRBS</p> 	<p>CWT</p> 	<p>HWT</p> 

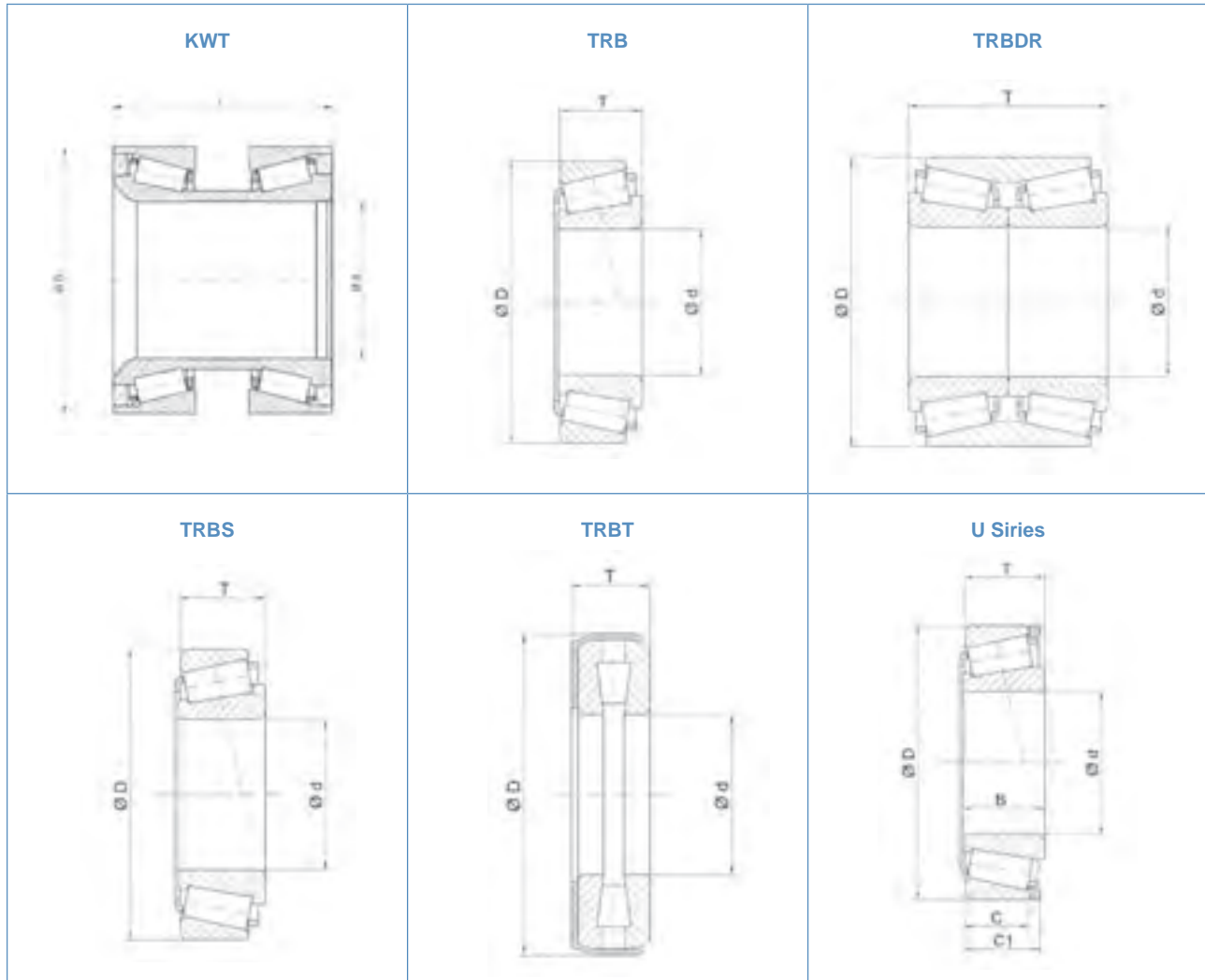

Experts in Bearing Solutions



Fersa Bearings, S.A.
PLAZA - Calle Bari, 18
50.195 Zaragoza - Spain
T +34 976 333 850
F +34 976 348 935
fersa@fersa.com

www.fersa.com

